



### FEATURES

- High common-mode transient immunity: 100 kV/μs**
- High robustness to radiated and conducted noise**
- Low propagation delay**
  - 13 ns maximum for 5 V operation**
  - 15 ns maximum for 1.8 V operation**
- 150 Mbps maximum data rate**
- Safety and regulatory approvals (pending)**
  - UL recognition**
    - 3000 V rms for 1 minute per UL 1577**
  - CSA component acceptance notice 5A**
  - VDE certificate of conformity**
    - DIN V VDE V 0884-10 (VDE V 0884-10):2006-12**
    - V<sub>IORM</sub> = 565 V peak**
  - CQC Certification per GB4943.1-2011**
- Backward compatibility**
  - Pin compatible with the ADuM1100**
- Low dynamic power consumption**
- 1.8 V to 5 V level translation**
- High temperature operation: 125°C**
- Fail-safe high or low options**
- 8-lead, RoHS-compliant, SOIC package**

### APPLICATIONS

- General-purpose single-channel isolation
- Industrial field bus isolation

### GENERAL DESCRIPTION

The ADuM110N is a single-channel digital isolator based on Analog Devices, Inc., iCoupler® technology. Combining high speed, complementary metal-oxide semiconductor (CMOS) and monolithic air core transformer technology, this isolation component provides outstanding performance characteristics, superior to alternatives such as optocoupler devices and other integrated couplers. The maximum propagation delay is 13 ns with a pulse width distortion of less than 3 ns at 5 V operation.

The ADuM110N supports data rates as high as 150 Mbps with a withstand voltage rating of 3.0 kV rms (see the Ordering Guide). The device operates with the supply voltage on either side ranging from 1.8 V to 5 V, providing compatibility with lower voltage systems as well as enabling voltage translation functionality across the isolation barrier.

Unlike other optocoupler alternatives, dc correctness is ensured in the absence of input logic transitions. Two different fail-safe options are available, in which the outputs transition to a pre-determined state when the input power supply is not applied or the inputs are disabled. The ADuM110N is pin compatible with the ADuM1100.

### FUNCTIONAL BLOCK DIAGRAM

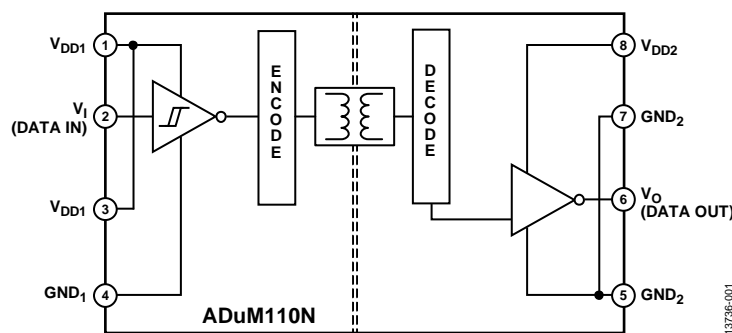

Figure 1.

<sup>1</sup> Protected by U.S. Patents 5,952,849; 6,873,065; 6,903,578; and 7,075,329. Other patents are pending.

## TABLE OF CONTENTS

Features .....	1	Recommended Operating Conditions .....	9
Applications .....	1	Absolute Maximum Ratings .....	10
General Description .....	1	ESD Caution.....	10
Functional Block Diagram .....	1	Pin Configuration and Function Descriptions.....	11
Revision History .....	2	Typical Performance Characteristics .....	12
Specifications.....	3	Applications Information .....	13
Electrical Characteristics—5 V Operation.....	3	Overview .....	13
Electrical Characteristics—3.3 V Operation .....	4	PCB Layout .....	13
Electrical Characteristics—2.5 V Operation .....	5	Propagation Delay Related Parameters .....	14
Electrical Characteristics—1.8 V Operation .....	6	Jitter Measurement.....	14
Insulation and Safety Related Specifications .....	7	Insulation Lifetime.....	14
Package Characteristics .....	7	Outline Dimensions .....	16
Regulatory Information.....	8	Ordering Guide .....	16
DIN V VDE V 0884-10 (VDE V 0884-10) Insulation			
Characteristics .....	8		

## REVISION HISTORY

10/15—Revision 0: Initial Version

## SPECIFICATIONS

### ELECTRICAL CHARACTERISTICS—5 V OPERATION

All typical specifications are at  $T_A = 25^\circ\text{C}$ ,  $V_{DD1} = V_{DD2} = 5\text{ V}$ . Minimum/maximum specifications apply over the entire recommended operation range of  $4.5\text{ V} \leq V_{DD1} \leq 5.5\text{ V}$ ,  $4.5\text{ V} \leq V_{DD2} \leq 5.5\text{ V}$ , and  $-40^\circ\text{C} \leq T_A \leq +125^\circ\text{C}$ , unless otherwise noted. Switching specifications are tested with  $C_L = 15\text{ pF}$  and CMOS signal levels, unless otherwise noted. Supply currents are specified with 50% duty cycle signals.

Table 1.

Parameter	Symbol	Min	Typ	Max	Unit	Test Conditions/Comments
<b>SWITCHING SPECIFICATIONS</b>						
Pulse Width	PW	6.6			ns	Within pulse width distortion (PWD) limit
Data Rate		150			Mbps	Within PWD limit
Propagation Delay	$t_{PHL}$ , $t_{PLH}$	4.8	7.2	13	ns	50% input to 50% output
Pulse Width Distortion	PWD		0.5	3	ns	$ t_{PLH} - t_{PHL} $
Change vs. Temperature			1.5		ps/ $^\circ\text{C}$	
Propagation Delay Skew	$t_{PSK}$			6.0	ns	Between any two units at the same temperature, voltage, and load
Jitter			380		ps p-p	See the Jitter Measurement section
			55		ps rms	See the Jitter Measurement section
<b>DC SPECIFICATIONS</b>						
Input Threshold						
Logic High	$V_{IH}$	$0.7 \times V_{DD1}$			V	
Logic Low	$V_{IL}$			$0.3 \times V_{DD1}$	V	
Output Voltage						
Logic High	$V_{OH}$	$V_{DD2} - 0.1$	$V_{DD2}$		V	Output current ( $I_o$ ) = $-20\ \mu\text{A}$ , input voltage ( $V_i$ ) = $V_{IH}$
Logic Low	$V_{OL}$	$V_{DD2} - 0.4$	$V_{DD2} - 0.2$	0.1	V	$I_o = 20\ \mu\text{A}$ , $V_i = V_{IL}$
Logic Low			0.0	0.4	V	$I_o = 4\ \text{mA}$ , $V_i = V_{IL}$
Input Current per Channel	$I_i$	-10	+0.01	+10	$\mu\text{A}$	$0\text{ V} \leq V_i \leq V_{DD1}$
Quiescent Supply Current						
$I_{DD1(Q)}$			0.9	1.4	mA	$V_i = 0$ (N0), 1 (N1) <sup>1</sup>
$I_{DD2(Q)}$			1.0	1.3	mA	$V_i = 0$ (N0), 1 (N1) <sup>1</sup>
$I_{DD1(Q)}$			3.6	6.0	mA	$V_i = 1$ (N0), 0 (N1) <sup>1</sup>
$I_{DD2(Q)}$			1.0	1.4	mA	$V_i = 1$ (N0), 0 (N1) <sup>1</sup>
Dynamic Supply Current						
Dynamic Output	$I_{DD1(D)}$		0.01		mA/Mbps	Inputs switching, 50% duty cycle
Dynamic Input	$I_{DD0(D)}$		0.02		mA/Mbps	Inputs switching, 50% duty cycle
Undervoltage Lockout	UVLO					
Positive $V_{DDx}$ Threshold	$V_{DDxUV+}$		1.6		V	
Negative $V_{DDx}$ Threshold	$V_{DDxUV-}$		1.5		V	
$V_{DDx}$ Hysteresis	$V_{DDxUVH}$		0.1		V	
<b>AC SPECIFICATIONS</b>						
Output Rise/Fall Time	$t_R/t_F$		2.5		ns	10% to 90%
Common-Mode Transient Immunity <sup>2</sup>	$ CM_H $	75	100		kV/ $\mu\text{s}$	$V_i = V_{DD1}$ , $V_{CM} = 1000\text{ V}$ , transient magnitude = 800 V
	$ CM_L $	75	100		kV/ $\mu\text{s}$	$V_i = 0\text{ V}$ , $V_{CM} = 1000\text{ V}$ , transient magnitude = 800 V

<sup>1</sup> N0 indicates the ADuM110N0 models and N1 indicates the ADuM110N1 models. See the Ordering Guide section.

<sup>2</sup>  $|CM_x|$  is the maximum common-mode voltage slew rate that can be sustained while maintaining the voltage output ( $V_o$ )  $> 0.8 V_{DD2}$ .  $|CM_L|$  is the maximum common-mode voltage slew rate that can be sustained while maintaining  $V_o > 0.8\text{ V}$ . The common-mode voltage slew rates apply to both the rising and falling common-mode voltage edges.

Table 2. Total Supply Current vs. Data Throughput—5 V Operation

Parameter	Symbol	1 Mbps			25 Mbps			100 Mbps			Unit
		Min	Typ	Max	Min	Typ	Max	Min	Typ	Max	
SUPPLY CURRENT											
Supply Current Side 1	I <sub>DD1</sub>		2.2	3.7		2.5	3.9		3.6	4.9	mA
Supply Current Side 2	I <sub>DD2</sub>		1.1	1.6		1.6	2.3		3.1	4.6	mA

**ELECTRICAL CHARACTERISTICS—3.3 V OPERATION**

All typical specifications are at  $T_A = 25^\circ\text{C}$ ,  $V_{DD1} = V_{DD2} = 3.3\text{ V}$ . Minimum/maximum specifications apply over the entire recommended operation range:  $3.0\text{ V} \leq V_{DD1} \leq 3.6\text{ V}$ ,  $3.0\text{ V} \leq V_{DD2} \leq 3.6\text{ V}$ , and  $-40^\circ\text{C} \leq T_A \leq +125^\circ\text{C}$ , unless otherwise noted. Switching specifications are tested with  $C_L = 15\text{ pF}$  and CMOS signal levels, unless otherwise noted. Supply currents are specified with 50% duty cycle signals.

Table 3.

Parameter	Symbol	Min	Typ	Max	Unit	Test Conditions/Comments
SWITCHING SPECIFICATIONS						
Pulse Width	PW	6.6			ns	Within PWD limit
Data Rate		150			Mbps	Within PWD limit
Propagation Delay	$t_{PHL}, t_{PLH}$	4.8	6.8	14	ns	50% input to 50% output
Pulse Width Distortion	PWD		0.7	3	ns	$ t_{PLH} - t_{PHL} $
Change vs. Temperature			1.5		ps/°C	
Propagation Delay Skew	$t_{PSK}$			7.0	ns	Between any two units at the same temperature, voltage, and load
Jitter			290		ps p-p	See the Jitter Measurement section
			45		ps rms	See the Jitter Measurement section
DC SPECIFICATIONS						
Input Threshold						
Logic High	$V_{IH}$	$0.7 \times V_{DD1}$			V	
Logic Low	$V_{IL}$			$0.3 \times V_{DD1}$	V	
Output Voltage						
Logic High	$V_{OH}$	$V_{DD2} - 0.1$	$V_{DD2}$		V	$I_O = -20\ \mu\text{A}, V_I = V_{IH}$
		$V_{DD2} - 0.4$	$V_{DD2} - 0.2$		V	$I_O = -2\ \text{mA}, V_I = V_{IH}$
Logic Low	$V_{OL}$		0.0	0.1	V	$I_O = 20\ \mu\text{A}, V_I = V_{IL}$
			0.2	0.4	V	$I_O = 2\ \text{mA}, V_I = V_{IL}$
Input Current per Channel	$I_i$	-10	+0.01	+10	$\mu\text{A}$	$0\text{ V} \leq V_I \leq V_{DD1}$
Quiescent Supply Current						
	$I_{DD1(Q)}$		0.8	1.3	mA	$V_I = 0\text{ (NO)}, 1\text{ (N1)}^1$
	$I_{DD2(Q)}$		0.9	1.4	mA	$V_I = 0\text{ (NO)}, 1\text{ (N1)}^1$
	$I_{DD1(Q)}$		3.6	5.8	mA	$V_I = 1\text{ (NO)}, 0\text{ (N1)}^1$
	$I_{DD2(Q)}$		0.9	1.4	mA	$V_I = 1\text{ (NO)}, 0\text{ (N1)}^1$
Dynamic Supply Current						
Dynamic Input	$I_{DDI(D)}$		0.01		mA/Mbps	Inputs switching, 50% duty cycle
Dynamic Output	$I_{DDO(D)}$		0.01		mA/Mbps	Inputs switching, 50% duty cycle
Undervoltage Lockout	UVLO					
Positive $V_{DDx}$ Threshold	$V_{DDxUV+}$		1.6		V	
Negative $V_{DDx}$ Threshold	$V_{DDxUV-}$		1.5		V	
$V_{DDx}$ Hysteresis	$V_{DDxUVH}$		0.1		V	

Parameter	Symbol	Min	Typ	Max	Unit	Test Conditions/Comments
AC SPECIFICATIONS						
Output Rise/Fall Time	$t_R/t_F$		2.5		ns	10% to 90%
Common-Mode Transient Immunity <sup>2</sup>	$ CM_H $	75	100		kV/ $\mu$ s	$V_I = V_{DD1}$ , $V_{CM} = 1000$ V, transient magnitude = 800 V
	$ CM_L $	75	100		kV/ $\mu$ s	$V_I = 0$ V, $V_{CM} = 1000$ V, transient magnitude = 800 V

<sup>1</sup> N0 indicates the ADuM110N0 models and N1 indicates the ADuM110N1 models. See the Ordering Guide section.

<sup>2</sup>  $|CM_H|$  is the maximum common-mode voltage slew rate that can be sustained while maintaining the voltage output ( $V_O$ ) > 0.8  $V_{DD2}$ .  $|CM_L|$  is the maximum common-mode voltage slew rate that can be sustained while maintaining  $V_O > 0.8$  V. The common-mode voltage slew rates apply to both rising and falling common-mode voltage edges.

Table 4. Total Supply Current vs. Data Throughput—3.3 V Operation

Parameter	Symbol	1 Mbps			25 Mbps			100 Mbps			Unit
		Min	Typ	Max	Min	Typ	Max	Min	Typ	Max	
SUPPLY CURRENT											
Supply Current Side 1	$I_{DD1}$		2.2	3.5		2.4	3.6		3.2	4.6	mA
Supply Current Side 2	$I_{DD2}$		0.9	1.5		1.4	2.0		2.8	4.3	mA

## ELECTRICAL CHARACTERISTICS—2.5 V OPERATION

All typical specifications are at  $T_A = 25^\circ\text{C}$ ,  $V_{DD1} = V_{DD2} = 2.5$  V. Minimum/maximum specifications apply over the entire recommended operation range:  $2.25 \text{ V} \leq V_{DD1} \leq 2.75 \text{ V}$ ,  $2.25 \text{ V} \leq V_{DD2} \leq 2.75 \text{ V}$ ,  $-40^\circ\text{C} \leq T_A \leq +125^\circ\text{C}$ , unless otherwise noted. Switching specifications are tested with  $C_L = 15$  pF and CMOS signal levels, unless otherwise noted. Supply currents are specified with 50% duty cycle signals.

Table 5.

Parameter	Symbol	Min	Typ	Max	Unit	Test Conditions/Comments
SWITCHING SPECIFICATIONS						
Pulse Width	PW	6.6			ns	Within PWD limit
Data Rate		150			Mbps	Within PWD limit
Propagation Delay	$t_{PHL}$ , $t_{PLH}$	5.0	7.0	14	ns	50% input to 50% output
Pulse Width Distortion	PWD		0.7	3	ns	$ t_{PLH} - t_{PHL} $
Change vs. Temperature			1.5		ps/ $^\circ\text{C}$	
Propagation Delay Skew	$t_{PSK}$			7.0	ns	Between any two units at the same temperature, voltage, load
Jitter			320		ps p-p	See the Jitter Measurement section
			65		ps rms	See the Jitter Measurement section
DC SPECIFICATIONS						
Input Threshold						
Logic High	$V_{IH}$	$0.7 \times V_{DD1}$			V	
Logic Low	$V_{IL}$			$0.3 \times V_{DD1}$	V	
Output Voltage						
Logic High	$V_{OH}$	$V_{DD2} - 0.1$	$V_{DD2}$		V	$I_O = -20 \mu\text{A}$ , $V_I = V_{IH}$
		$V_{DD2} - 0.4$	$V_{DD2} - 0.2$		V	$I_O = -2 \text{ mA}$ , $V_I = V_{IH}$
Logic Low	$V_{OL}$		0.0	0.1	V	$I_O = 20 \mu\text{A}$ , $V_I = V_{IL}$
			0.2	0.4	V	$I_O = 2 \text{ mA}$ , $V_I = V_{IL}$
Input Current per Channel	$I_I$	-10	+0.01	+10	$\mu\text{A}$	$0 \text{ V} \leq V_I \leq V_{DD1}$
Quiescent Supply Current						
	$I_{DD1(Q)}$		0.8	1.1	mA	$V_I = 0$ (N0), 1 (N1) <sup>1</sup>
	$I_{DD2(Q)}$		0.9	1.2	mA	$V_I = 0$ (N0), 1 (N1) <sup>1</sup>
	$I_{DD1(Q)}$		3.5	5.6	mA	$V_I = 1$ (N0), 0 (N1) <sup>1</sup>
	$I_{DD2(Q)}$		1.0	1.2	mA	$V_I = 1$ (N0), 0 (N1) <sup>1</sup>
Dynamic Supply Current						
Dynamic Input	$I_{DDI(D)}$		0.01		mA/Mbps	Inputs switching, 50% duty cycle
Dynamic Output	$I_{DDO(D)}$		0.01		mA/Mbps	Inputs switching, 50% duty cycle

Parameter	Symbol	Min	Typ	Max	Unit	Test Conditions/Comments
Undervoltage Lockout						
Positive $V_{DDx}$ Threshold	$V_{DDxUV+}$		1.6		V	
Negative $V_{DDx}$ Threshold	$V_{DDxUV-}$		1.5		V	
$V_{DDx}$ Hysteresis	$V_{DDxUVH}$		0.1		V	
AC SPECIFICATIONS						
Output Rise/Fall Time	$t_R/t_F$		2.5		ns	10% to 90%
Common-Mode Transient Immunity <sup>2</sup>	$ CM_H $	75	100		kV/ $\mu$ s	$V_I = V_{DD1}$ , $V_{CM} = 1000$ V, transient magnitude = 800 V
	$ CM_L $	75	100		kV/ $\mu$ s	$V_I = 0$ V, $V_{CM} = 1000$ V, transient magnitude = 800 V

<sup>1</sup> N0 indicates the ADuM110N0 models and N1 indicates the ADuM110N1 models. See the Ordering Guide section.

<sup>2</sup>  $|CM_H|$  is the maximum common-mode voltage slew rate that can be sustained while maintaining the voltage output ( $V_O$ ) > 0.8  $V_{DD2}$ .  $|CM_L|$  is the maximum common-mode voltage slew rate that can be sustained while maintaining  $V_O > 0.8$  V. The common-mode voltage slew rates apply to both rising and falling common-mode voltage edges.

Table 6. Total Supply Current vs. Data Throughput—2.5 V Operation

Parameter	Symbol	1 Mbps			25 Mbps			100 Mbps			Unit
		Min	Typ	Max	Min	Typ	Max	Min	Typ	Max	
SUPPLY CURRENT											
Supply Current Side 1	$I_{DD1}$		2.2	3.4		2.4	3.6		3.2	4.3	mA
Supply Current Side 2	$I_{DD2}$		0.9	1.4		1.3	1.8		2.3	3.5	mA

## ELECTRICAL CHARACTERISTICS—1.8 V OPERATION

All typical specifications are at  $T_A = 25^\circ\text{C}$ ,  $V_{DD1} = V_{DD2} = 1.8$  V. Minimum/maximum specifications apply over the entire recommended operation range:  $1.7\text{ V} \leq V_{DD1} \leq 1.9\text{ V}$ ,  $1.7\text{ V} \leq V_{DD2} \leq 1.9\text{ V}$ , and  $-40^\circ\text{C} \leq T_A \leq +125^\circ\text{C}$ , unless otherwise noted. Switching specifications are tested with  $C_L = 15$  pF and CMOS signal levels, unless otherwise noted. Supply currents are specified with 50% duty cycle signals.

Table 7.

Parameter	Symbol	Min	Typ	Max	Unit	Test Conditions/Comments
SWITCHING SPECIFICATIONS						
Pulse Width	PW	6.6			ns	Within PWD limit
Data Rate		150			Mbps	Within PWD limit
Propagation Delay	$t_{PHL}$ , $t_{PLH}$	5.8	8.7	15	ns	50% input to 50% output
Pulse Width Distortion	PWD		0.7	3	ns	$ t_{PLH} - t_{PHL} $
Change vs. Temperature			1.5		ps/ $^\circ\text{C}$	
Propagation Delay Skew	$t_{PSK}$			7.0	ns	Between any two units at the same temperature, voltage, and load
Jitter			630		ps p-p	See the Jitter Measurement section
			190		ps rms	See the Jitter Measurement section
DC SPECIFICATIONS						
Input Threshold						
Logic High	$V_{IH}$	$0.7 \times V_{DD1}$			V	
Logic Low	$V_{IL}$			$0.3 \times V_{DD1}$	V	
Output Voltage						
Logic High	$V_{OH}$	$V_{DD2} - 0.1$	$V_{DD2}$		V	$I_O = -20\ \mu\text{A}$ , $V_I = V_{IH}$
		$V_{DD2} - 0.4$	$V_{DD2} - 0.2$		V	$I_O = -2\ \text{mA}$ , $V_I = V_{IH}$
Logic Low	$V_{OL}$		0.0	0.1	V	$I_O = 20\ \mu\text{A}$ , $V_I = V_{IL}$
			0.2	0.4	V	$I_O = 2\ \text{mA}$ , $V_I = V_{IL}$
Input Current per Channel	$I_i$	-10	+0.01	+10	$\mu\text{A}$	$0\text{ V} \leq V_I \leq V_{DD1}$
Quiescent Supply Current	$I_{DD1(Q)}$		0.7	1.1	mA	$V_I = 0$ (N0), 1 (N1) <sup>1</sup>
	$I_{DD2(Q)}$		0.9	1.2	mA	$V_I = 0$ (N0), 1 (N1) <sup>1</sup>
	$I_{DD1(Q)}$		3.4	5.4	mA	$V_I = 1$ (N0), 0 (N1) <sup>1</sup>
	$I_{DD2(Q)}$		0.9	1.2	mA	$V_I = 1$ (N0), 0 (N1) <sup>1</sup>

Parameter	Symbol	Min	Typ	Max	Unit	Test Conditions/Comments
Dynamic Supply Current						
Dynamic Input	$I_{DDI(D)}$		0.01		mA/Mbps	Inputs switching, 50% duty cycle
Dynamic Output	$I_{DDO(D)}$		0.01		mA/Mbps	Inputs switching, 50% duty cycle
Undervoltage Lockout	UVLO					
Positive $V_{DDx}$ Threshold	$V_{DDxUV+}$		1.6		V	
Negative $V_{DDx}$ Threshold	$V_{DDxUV-}$		1.5		V	
$V_{DDx}$ Hysteresis	$V_{DDxUVH}$		0.1		V	
AC SPECIFICATIONS						
Output Rise/Fall Time	$t_R/t_F$		2.5		ns	10% to 90%
Common-Mode Transient Immunity <sup>2</sup>	$ CM_H $	75	100		kV/ $\mu$ s	$V_I = V_{DD1}$ , $V_{CM} = 1000$ V, transient magnitude = 800 V
	$ CM_L $	75	100		kV/ $\mu$ s	$V_I = 0$ V, $V_{CM} = 1000$ V, transient magnitude = 800 V

<sup>1</sup> N0 indicates the ADuM110N0 models and N1 indicates the ADuM110N1 models. See the Ordering Guide section.

<sup>2</sup>  $|CM_H|$  is the maximum common-mode voltage slew rate that can be sustained while maintaining the voltage output ( $V_O$ ) > 0.8  $V_{DD2}$ .  $|CM_L|$  is the maximum common-mode voltage slew rate that can be sustained while maintaining  $V_O > 0.8$  V. The common-mode voltage slew rates apply to both rising and falling common-mode voltage edges.

Table 8. Total Supply Current vs. Data Throughput—1.8 V Operation

Parameter	Symbol	1 Mbps			25 Mbps			100 Mbps			Unit
		Min	Typ	Max	Min	Typ	Max	Min	Typ	Max	
SUPPLY CURRENT											
Supply Current Side 1	$I_{DD1}$		2.1	3.1		2.3	3.4		3.0	4.2	mA
Supply Current Side 2	$I_{DD2}$		0.9	1.2		1.2	1.6		2.2	3.2	mA

## INSULATION AND SAFETY RELATED SPECIFICATIONS

For additional information, see [www.analog.com/icouplersafety](http://www.analog.com/icouplersafety).

Table 9.

Parameter	Symbol	Value	Unit	Test Conditions/Comments
Rated Dielectric Insulation Voltage		3000	V rms	1-minute duration
Minimum External Air Gap (Clearance)	L (I01)	4.0	mm min	Measured from input terminals to output terminals, shortest distance through air
Minimum External Tracking (Creepage)	L (I02)	4.0	mm min	Measured from input terminals to output terminals, shortest distance path along body
Minimum Clearance in the Plane of the Printed Circuit Board (PCB Clearance)	L (PCB)	4.5	mm min	Measured from input terminals to output terminals, shortest distance through air, line of sight, in the PCB mounting plane
Minimum Internal Gap (Internal Clearance)		25.5	$\mu$ m min	Insulation distance through insulation
Tracking Resistance (Comparative Tracking Index)	CTI	>400	V	DIN IEC 112/VDE 0303 Part 1
Material Group		II		Material Group (DIN VDE 0110, 1/89, Table 1)

## PACKAGE CHARACTERISTICS

Table 10.

Parameter	Symbol	Min	Typ	Max	Unit	Test Conditions/Comments
Resistance (Input to Output) <sup>1</sup>	$R_{I-O}$		$10^{13}$		$\Omega$	
Capacitance (Input to Output) <sup>1</sup>	$C_{I-O}$		2		pF	$f = 1$ MHz
Input Capacitance <sup>2</sup>	$C_I$		4.0		pF	
IC Junction to Ambient Thermal Resistance	$\theta_{JA}$		80		$^{\circ}$ C/W	Thermocouple located at center of package underside

<sup>1</sup> The ADuM110N is considered a 2-terminal device: Pin 1 through Pin 4 are shorted together, and Pin 5 through Pin 8 are shorted together.

<sup>2</sup> Input capacitance is from any input data pin to ground.

**REGULATORY INFORMATION**

See Table 15 and the Insulation Lifetime section for details regarding recommended maximum working voltages for specific cross-isolation waveforms and insulation levels.

**Table 11.**

UL (Pending)	CSA (Pending)	VDE (Pending)	CQC (Pending)
Recognized Under 1577 Component Recognition Program <sup>1</sup>	Approved under CSA Component Acceptance Notice 5A	Certified according to DIN V VDE V 0884-10 (VDE V 0884-10):2006-12 <sup>2</sup>	Certified by CQC11-471543-2012
Single Protection, 3000 V rms Isolation Voltage	CSA 60950-1-07+A1+A2 and IEC 60950-1, Second Edition, +A1+A2	Basic insulation 565 V peak, $V_{IOSM} = 10$ kV peak	GB4943.1-2011
Double Protection, 3000 V rms Isolation Voltage	Basic insulation at 400 V rms (565 V peak) Reinforced insulation at 200 V rms (283 V peak) IEC 60601-1 Edition 3.1	Reinforced insulation, 565 V peak, $V_{IOSM} = 6000$ V peak	Basic insulation at 770 V rms (1089 V peak), reinforced insulation at 385 V rms (545 V peak), tropical climate, altitude $\leq 5000$ meters
File E214100	Basic insulation (1 MOPP), 250 V rms (354 V peak) CSA 61010-1-12 and IEC 61010-1 Third Edition		
	Basic insulation at 300 V rms (main), 400 V rms (565 V peak) Reinforced insulation at 300 V rms (main), 200 V (secondary) (283 V peak)		
	File 205078	File 2471900-4880-0001	File (pending)

<sup>1</sup> In accordance with UL 1577, each ADuM110N is proof tested by applying an insulation test voltage  $\geq 3600$  V rms for 1 sec.

<sup>2</sup> In accordance with DIN V VDE V 0884-10, each ADuM110N is proof tested by applying an insulation test voltage  $\geq 1059$  V peak for 1 sec (partial discharge detection limit = 5 pC). The \* marking branded on the component designates DIN V VDE V 0884-10 approval.

**DIN V VDE V 0884-10 (VDE V 0884-10) INSULATION CHARACTERISTICS**

This isolator is suitable for reinforced electrical isolation only within the safety limit data. Protective circuits ensure the maintenance of the safety data. The \* marking on packages denotes DIN V VDE V 0884-10 approval.

**Table 12.**

Description	Test Conditions/Comments	Symbol	Characteristic	Unit
Installation Classification per DIN VDE 0110			I to IV	
For Rated Mains Voltage $\leq 150$ V rms			I to III	
For Rated Mains Voltage $\leq 300$ V rms			I to III	
For Rated Mains Voltage $\leq 400$ V rms			40/105/21	
Climatic Classification			2	
Pollution Degree per DIN VDE 0110, Table 1				
Maximum Working Insulation Voltage		$V_{IORM}$	565	V peak
Input to Output Test Voltage, Method B1	$V_{IORM} \times 1.875 = V_{pd(m)}$ , 100% production test, $t_{ini} = t_m = 1$ sec, partial discharge $< 5$ pC	$V_{pd(m)}$	1059	V peak
Input to Output Test Voltage, Method A				
After Environmental Tests Subgroup 1	$V_{IORM} \times 1.5 = V_{pd(m)}$ , $t_{ini} = 60$ sec, $t_m = 10$ sec, partial discharge $< 5$ pC	$V_{pd(m)}$	848	V peak
After Input and/or Safety Test Subgroup 2 and Subgroup 3	$V_{IORM} \times 1.2 = V_{pd(m)}$ , $t_{ini} = 60$ sec, $t_m = 10$ sec, partial discharge $< 5$ pC		678	V peak
Highest Allowable Overvoltage		$V_{IOTM}$	4200	V peak
Surge Isolation Voltage				
Basic	V peak = 10.0 kV, 1.2 $\mu$ s rise time, 50 $\mu$ s, 50% fall time	$V_{IOSM}$	10,000	V peak
Reinforced	V peak = 10.0 kV, 1.2 $\mu$ s rise time, 50 $\mu$ s, 50% fall time	$V_{IOSM}$	6000	V peak



Description	Test Conditions/Comments	Symbol	Characteristic	Unit
Safety Limiting Values	Maximum value allowed in the event of a failure (see Figure 2)			
Maximum Junction Temperature		$T_S$	150	$^{\circ}\text{C}$
Total Power Dissipation at 25 $^{\circ}\text{C}$		PS	1.56	W
Insulation Resistance at $T_S$	$V_{IO} = 500\text{ V}$	$R_S$	$>10^9$	$\Omega$

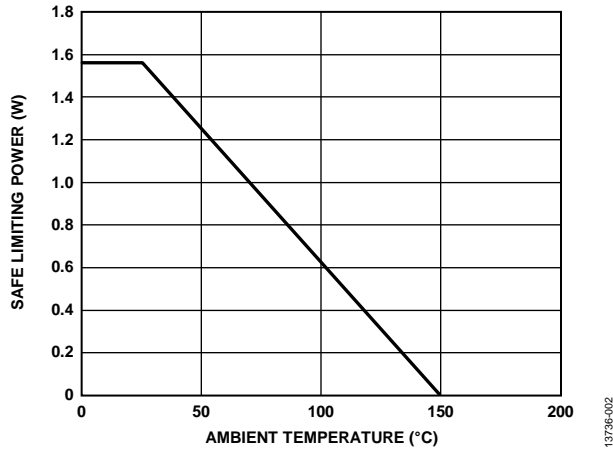

Figure 2. Thermal Derating Curve, Dependence of Safety Limiting Values with Ambient Temperature per DIN V VDE V 0884-10

**RECOMMENDED OPERATING CONDITIONS**

Table 13.

Parameter	Symbol	Rating
Operating Temperature	$T_A$	$-40^{\circ}\text{C}$ to $+125^{\circ}\text{C}$
Supply Voltages	$V_{DD1}, V_{DD2}$	1.7 V to 5.5 V
Input Signal Rise and Fall Times		1.0 ms

## ABSOLUTE MAXIMUM RATINGS

$T_A = 25^\circ\text{C}$ , unless otherwise noted.

Table 14.

Parameter	Rating
Storage Temperature ( $T_{ST}$ ) Range	$-65^\circ\text{C}$ to $+150^\circ\text{C}$
Ambient Operating Temperature ( $T_A$ ) Range	$-40^\circ\text{C}$ to $+125^\circ\text{C}$
Supply Voltages ( $V_{DD1}$ , $V_{DD2}$ )	$-0.5\text{ V}$ to $+7.0\text{ V}$
Input Voltages ( $V_i$ )	$-0.5\text{ V}$ to $V_{DD1} + 0.5\text{ V}$
Output Voltages ( $V_o$ )	$-0.5\text{ V}$ to $V_{DD2} + 0.5\text{ V}$
Average Output Current per Pin <sup>3</sup> Side 2 Output Current ( $I_{O2}$ )	$-10\text{ mA}$ to $+10\text{ mA}$
Common-Mode Transients <sup>4</sup>	$-150\text{ kV}/\mu\text{s}$ to $+150\text{ kV}/\mu\text{s}$

<sup>1</sup>  $V_{DD1}$  is the input side supply voltage.

<sup>2</sup>  $V_{DD2}$  is the output side supply voltage.

<sup>3</sup> See Figure 2 for the maximum rated current values for various temperatures.

<sup>4</sup> Refers to the common-mode transients across the insulation barrier.

Common-mode transients exceeding the absolute maximum ratings may cause latch-up or permanent damage.

Stresses at or above those listed under Absolute Maximum Ratings may cause permanent damage to the product. This is a stress rating only; functional operation of the product at these or any other conditions above those indicated in the operational section of this specification is not implied. Operation beyond the maximum operating conditions for extended periods may affect product reliability.

### ESD CAUTION



**ESD (electrostatic discharge) sensitive device.** Charged devices and circuit boards can discharge without detection. Although this product features patented or proprietary protection circuitry, damage may occur on devices subjected to high energy ESD. Therefore, proper ESD precautions should be taken to avoid performance degradation or loss of functionality.

Table 15. Maximum Continuous Working Voltage<sup>1</sup>

Parameter	Rating	Constraint
AC Voltage		
Bipolar Waveform		
Basic Insulation	789 V peak	Lifetime limited by package creepage maximum approved working voltage per IEC 60950-1
Reinforced Insulation	403 V peak	Lifetime limited by package creepage maximum approved working voltage per IEC 60950-1
Unipolar Waveform		
Basic Insulation	909 V peak	Lifetime limited by package creepage maximum approved working voltage per IEC 60950-1
Reinforced Insulation	469 V peak	Lifetime limited by package creepage maximum approved working voltage per IEC 60950-1
DC Voltage		
Basic Insulation	558 V peak	Lifetime limited by package creepage maximum approved working voltage per IEC 60950-1
Reinforced Insulation	285 V peak	Lifetime limited by package creepage maximum approved working voltage per IEC 60950-1

<sup>1</sup> Refers to the continuous voltage magnitude imposed across the isolation barrier. See the Insulation Lifetime section for more details.

### Truth Table

Table 16. Truth Table (Positive Logic)

$V_i$ Input <sup>1</sup>	$V_{DD1}$ State	$V_{DD2}$ State	Default Low (N0), <sup>2</sup> $V_o$ Output <sup>1</sup>	Default High (N1), <sup>2</sup> $V_o$ Output <sup>1</sup>	Test Conditions/ Comments
L	Powered	Powered	L	L	Normal operation
H	Powered	Powered	H	H	Normal operation
X <sup>3</sup>	Unpowered	Powered	L	H	Fail-safe output
X <sup>3</sup>	Powered	Unpowered	Indeterminate	Indeterminate	

<sup>1</sup> H means high, L means low, and X means don't care.

<sup>2</sup> N0 indicates the ADuM110N0 models and N1 indicates the ADuM110N1 models. See the Ordering Guide section.

<sup>3</sup> The input pin ( $V_i$ ) on the same side as an unpowered supply must be in a low state to avoid powering the device through its ESD protection circuitry.

## PIN CONFIGURATION AND FUNCTION DESCRIPTIONS

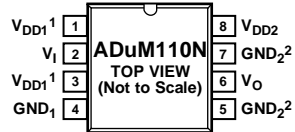

<sup>1</sup> PIN 1 AND PIN 3 ARE INTERNALLY CONNECTED. EITHER OR BOTH MAY BE USED FOR  $V_{DD1}$ .  
<sup>2</sup> PIN 5 AND PIN 7 ARE INTERNALLY CONNECTED. EITHER OR BOTH MAY BE USED FOR  $GND_2$ .

13726-004

Figure 3. Pin Configuration

Table 17. Pin Function Descriptions

Pin No.	Mnemonic	Description <sup>1</sup>
1	$V_{DD1}$	Supply Voltage for Isolator Side 1.
2	$V_I$	Logic Input.
3	$V_{DD1}$	Supply Voltage for Isolator Side 1.
4	$GND_1$	Ground 1. Ground reference for Isolator Side 1.
5	$GND_2$	Ground 2. Ground reference for Isolator Side 2.
6	$V_O$	Logic Output.
7	$GND_2$	Ground 2. Ground reference for Isolator Side 2.
8	$V_{DD2}$	Supply Voltage for Isolator Side 2.

<sup>1</sup> Refer to the [AN-1109 Application Note](#) for specific layout guidelines.

TYPICAL PERFORMANCE CHARACTERISTICS

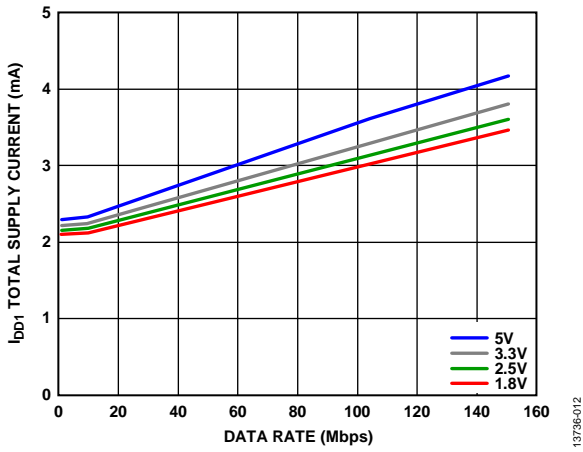

Figure 4.  $I_{DD1}$  Total Supply Current vs. Data Rate at Various Voltages

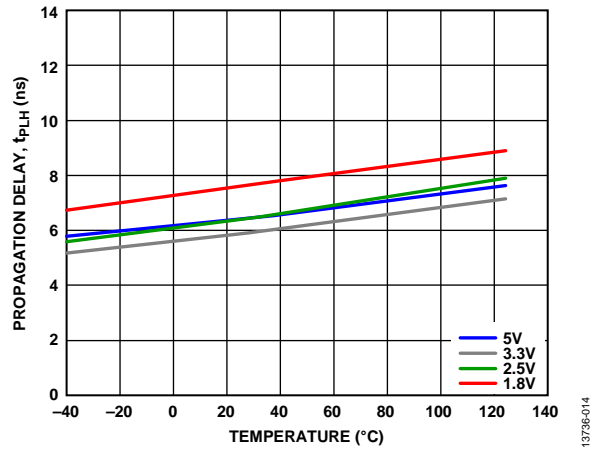

Figure 6. Propagation Delay,  $t_{PLH}$  vs. Temperature at Various Voltages

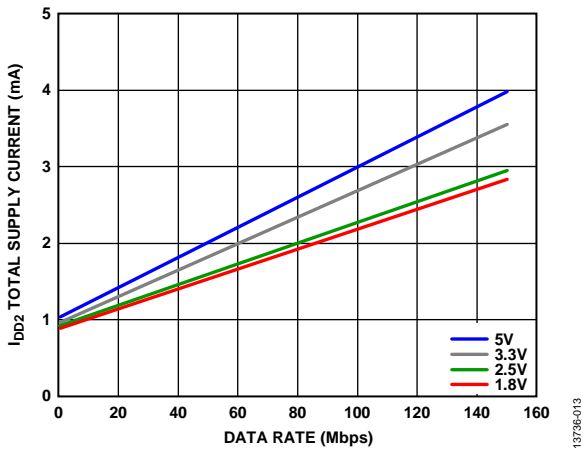

Figure 5.  $I_{DD2}$  Total Supply Current vs. Data Rate at Various Voltages

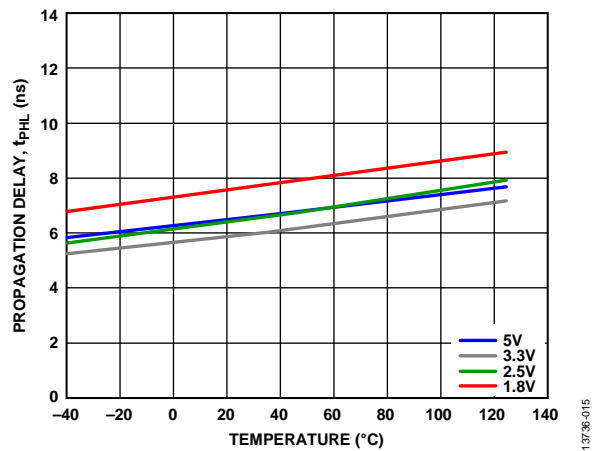

Figure 7. Propagation Delay,  $t_{PHL}$  vs. Temperature at Various Voltages

## APPLICATIONS INFORMATION

### OVERVIEW

The ADuM110N uses a high frequency carrier to transmit data across the isolation barrier using *i*Coupler chip scale transformer coils separated by layers of polyimide isolation. Using an on-off keying (OOK) technique and the differential architecture shown in Figure 9 and Figure 10, the ADuM110N has very low propagation delay and high speed. Internal regulators and input/output design techniques allow logic and supply voltages over a wide range from 1.7 V to 5.5 V, offering voltage translation of 1.8 V, 2.5 V, 3.3 V, and 5 V logic. The architecture is designed for high common-mode transient immunity and high immunity to electrical noise and magnetic interference. Radiated emissions are minimized with a spread spectrum OOK carrier and other techniques.

Figure 9 shows the waveforms for the ADuM110N0 models, which have the condition of the fail-safe output state equal to low, where the carrier waveform is off when the input state is low. If the input side is off or not operating, the fail-safe output state of low (noted by a 0 in the model number) sets the output to low. For the ADuM110N1 models, which have a fail-safe output state of high, Figure 10 shows the conditions where the carrier waveform is off when the input state is high. When the input side is off or not operating, the fail-safe output state of high (noted by a 1 in the model number) sets the output to high. See the Ordering Guide for the model numbers that have the fail-safe output state of low or the fail-safe output state of high.

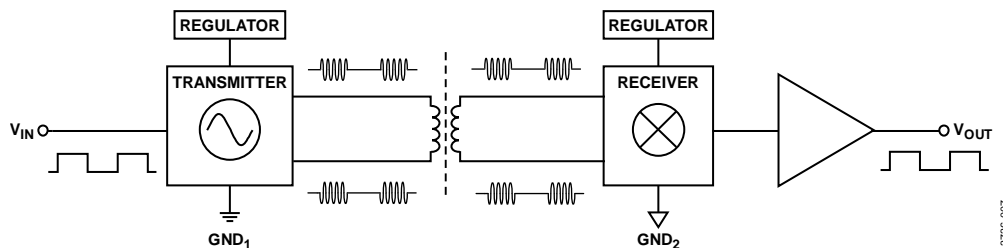

Figure 9. Operational Block Diagram of a Single Channel with a Low Fail-Safe Output State

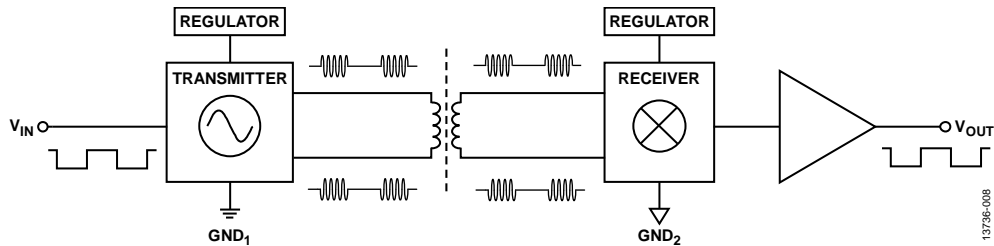

Figure 10. Operational Block Diagram of a Single Channel with a High Fail-Safe Output State

### PRINTED CIRCUIT BOARD (PCB) LAYOUT

The ADuM110N digital isolator requires no external interface circuitry for the logic interfaces. Power supply bypassing is strongly recommended at the input and output supply pins (see Figure 8). Bypass capacitors are most conveniently connected between Pin 1 and Pin 4 for  $V_{DD1}$  and between Pin 5 and Pin 8 for  $V_{DD2}$ . The recommended bypass capacitor value is between 0.01  $\mu$ F and 0.1  $\mu$ F. The total lead length between both ends of the capacitor and the input power supply pin must not exceed 10 mm.

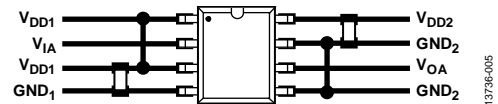

Figure 8. Recommended PCB Layout

In applications involving high common-mode transients, ensure that board coupling across the isolation barrier is minimized. Furthermore, design the board layout such that any coupling that does occur equally affects all pins on a given component side. Failure to ensure this can cause voltage differentials between pins exceeding the Absolute Maximum Ratings of the device, thereby leading to latch-up or permanent damage.

See the AN-1109 Application Note for board layout guidelines.

## PROPAGATION DELAY RELATED PARAMETERS

Propagation delay is a parameter that describes the time it takes a logic signal to propagate through a component. The propagation delay to a Logic 0 output may differ from the propagation delay to a Logic 1 output.

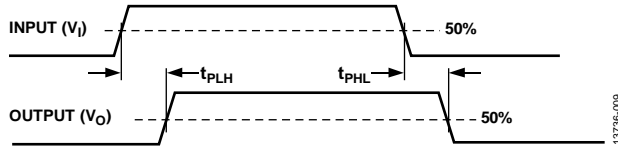

Figure 11. Propagation Delay Parameters

Pulse width distortion is the maximum difference between these two propagation delay values and is an indication of how accurately the timing of the input signal is preserved.

Propagation delay skew is the maximum amount the propagation delay differs between multiple ADuM110N components operating under the same conditions

## JITTER MEASUREMENT

Figure 12 shows the eye diagram for the ADuM110N. The measurement was taken using an Agilent 81110A pulse pattern generator at 150 Mbps with pseudorandom bit sequences (PRBS)  $2(n-1)$ ,  $n = 14$ , for 5 V supplies. Jitter was measured with the Tektronix Model 5104B oscilloscope, 1 GHz, 10 GS/sec with the DPOJET jitter and eye diagram analysis tools. The result shows a typical measurement on the ADuM110N with 380 ps p-p jitter.

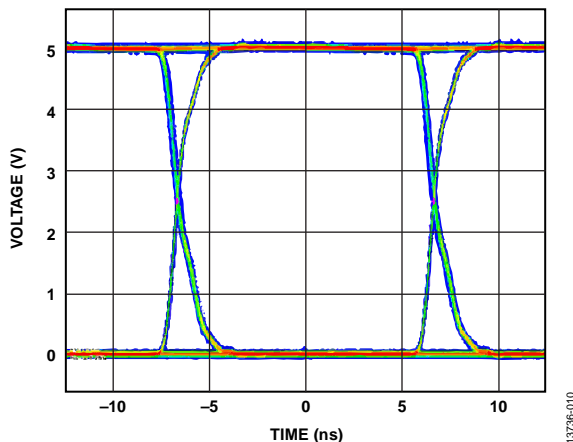

Figure 12. Eye Diagram

## INSULATION LIFETIME

All insulation structures eventually break down when subjected to voltage stress over a sufficiently long period. The rate of insulation degradation is dependent on the characteristics of the voltage waveform applied across the insulation as well as on the materials and material interfaces.

The two types of insulation degradation of primary interest are breakdown along surfaces exposed to the air and insulation wear out. Surface breakdown is the phenomenon of surface tracking, and the primary determinant of surface creepage requirements in system level standards. Insulation wear out is the phenomenon where charge injection or displacement currents

inside the insulation material cause long-term insulation degradation.

### Surface Tracking

Surface tracking is addressed in electrical safety standards by setting a minimum surface creepage based on the working voltage, the environmental conditions, and the properties of the insulation material. Safety agencies perform characterization testing on the surface insulation of components that allows the components to be categorized in different material groups. Lower material group ratings are more resistant to surface tracking and, therefore, can provide adequate lifetime with smaller creepage. The minimum creepage for a given working voltage and material group is in each system level standard and is based on the total rms voltage across the isolation, pollution degree, and material group. The material group and creepage for the ADuM110N isolators are presented in Table 9.

### Insulation Wear Out

The lifetime of insulation caused by wear out is determined by its thickness, material properties, and the voltage stress applied. It is important to verify that the product lifetime is adequate at the application working voltage. The working voltage supported by an isolator for wear out may not be the same as the working voltage supported for tracking. It is the working voltage applicable to tracking that is specified in most standards.

Testing and modeling have shown that the primary driver of long-term degradation is displacement current in the polyimide insulation causing incremental damage. The stress on the insulation can be broken down into broad categories, such as: dc stress, which causes very little wear out because there is no displacement current, and an ac component time varying voltage stress, which causes wear out.

The ratings in certification documents are usually based on 60 Hz sinusoidal stress because this reflects isolation from line voltage. However, many practical applications have combinations of 60 Hz ac and dc across the barrier as shown in Equation 1. Because only the ac portion of the stress causes wear out, the equation can be rearranged to solve for the ac rms voltage, as is shown in Equation 2. For insulation wear out with the polyimide materials used in these products, the ac rms voltage determines the product lifetime.

$$V_{RMS} = \sqrt{V_{ACRMS}^2 + V_{DC}^2} \quad (1)$$

or

$$V_{ACRMS} = \sqrt{V_{RMS}^2 - V_{DC}^2} \quad (2)$$

where:

$V_{ACRMS}$  is the time varying portion of the working voltage.

$V_{DC}$  is the dc offset of the working voltage.

$V_{RMS}$  is the total rms working voltage.

**Calculation and Use of Parameters Example**

The following example frequently arises in power conversion applications. Assume that the line voltage on one side of the isolation is 240 V<sub>AC RMS</sub> and a 400 V<sub>DC</sub> bus voltage is present on the other side of the isolation barrier. The isolator material is polyimide. To establish the critical voltages in determining the creepage, clearance and lifetime of a device, see Figure 13 and the following equations.

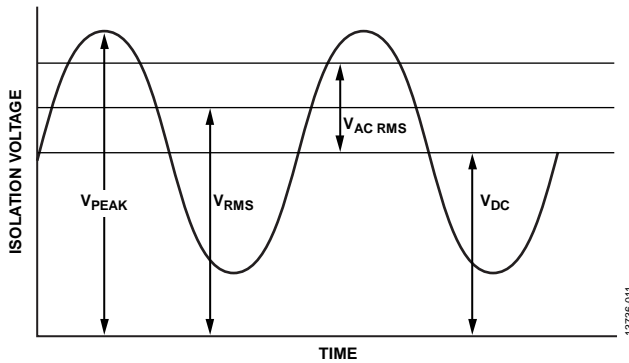

Figure 13. Critical Voltage Example

The working voltage across the barrier from Equation 1 is

$$V_{RMS} = \sqrt{V_{AC\ RMS}^2 + V_{DC}^2}$$

$$V_{RMS} = \sqrt{240^2 + 400^2}$$

$$V_{RMS} = 466\ V$$

This is the working voltage used together with the material group and pollution degree when looking up the creepage required by a system standard.

To determine if the lifetime is adequate, obtain the time varying portion of the working voltage. To obtain the ac rms voltage, use Equation 2.

$$V_{ACRMS} = \sqrt{V_{RMS}^2 - V_{DC}^2}$$

$$V_{ACRMS} = \sqrt{466^2 - 400^2}$$

$$V_{ACRMS} = 240\ V\ rms$$

In this case, the ac rms voltage is simply the line voltage of 240 V rms. This calculation is more relevant when the waveform is not sinusoidal. The value is compared to the limits for working voltage in Table 15 for the expected lifetime, less than a 60 Hz sine wave, and it is well within the limit for a 50-year service life.

Note that the dc working voltage limit in Table 15 is set by the creepage of the package as specified in IEC 60664-1. This value can differ for specific system level standards.

## OUTLINE DIMENSIONS

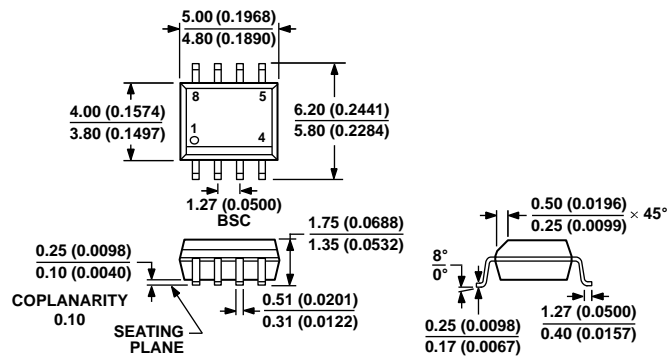

COMPLIANT TO JEDEC STANDARDS MS-012-AA  
 CONTROLLING DIMENSIONS ARE IN MILLIMETERS; INCH DIMENSIONS  
 (IN PARENTHESES) ARE ROUNDED-OFF MILLIMETER EQUIVALENTS FOR  
 REFERENCE ONLY AND ARE NOT APPROPRIATE FOR USE IN DESIGN.

Figure 14. 8-Lead Standard Small Outline Package [SOIC\_N]  
 Narrow Body (R-8)

Dimensions shown in millimeters and (inches)

012407-A

## ORDERING GUIDE

Model <sup>1</sup>	Temperature Range	No. of Inputs, V <sub>DD1</sub> Side	No. of Inputs, V <sub>DD2</sub> Side	Withstand Voltage Rating (kV rms)	Fail-Safe Output State	Package Description	Package Option
ADuM110N1BRZ	-40°C to +125°C	1	0	3.0	High	8-Lead SOIC_N	R-8
ADuM110N1BRZ-RL7	-40°C to +125°C	1	0	3.0	High	8-Lead SOIC_N	R-8
ADuM110N0BRZ	-40°C to +125°C	1	0	3.0	Low	8-Lead SOIC_N	R-8
ADuM110N0BRZ-RL7	-40°C to +125°C	1	0	3.0	Low	8-Lead SOIC_N	R-8

<sup>1</sup> Z = RoHS Compliant Part.





## Стандарт Электрон Связь

Мы молодая и активно развивающаяся компания в области поставок электронных компонентов. Мы поставляем электронные компоненты отечественного и импортного производства напрямую от производителей и с крупнейших складов мира.

Благодаря сотрудничеству с мировыми поставщиками мы осуществляем комплексные и плановые поставки широчайшего спектра электронных компонентов.

Собственная эффективная логистика и склад в обеспечивает надежную поставку продукции в точно указанные сроки по всей России.

Мы осуществляем техническую поддержку нашим клиентам и предпродажную проверку качества продукции. На все поставляемые продукты мы предоставляем гарантию .

Осуществляем поставки продукции под контролем ВП МО РФ на предприятия военно-промышленного комплекса России , а также работаем в рамках 275 ФЗ с открытием отдельных счетов в уполномоченном банке. Система менеджмента качества компании соответствует требованиям ГОСТ ISO 9001.

Минимальные сроки поставки, гибкие цены, неограниченный ассортимент и индивидуальный подход к клиентам являются основой для выстраивания долгосрочного и эффективного сотрудничества с предприятиями радиоэлектронной промышленности, предприятиями ВПК и научно-исследовательскими институтами России.

С нами вы становитесь еще успешнее!

### Наши контакты:

**Телефон:** +7 812 627 14 35

**Электронная почта:** [sales@st-electron.ru](mailto:sales@st-electron.ru)

**Адрес:** 198099, Санкт-Петербург,  
Промышленная ул, дом № 19, литера Н,  
помещение 100-Н Офис 331