



Aluminum electrolytic capacitors

Axial-lead and soldering star capacitors

Series/Type: B41692, B41792

Date: December 2019

Applications

- Automotive electronics

Features

- High vibration stability, special design with high vibration stability up to 60 g available upon request
- Long useful life, 2000 h at up to 140 °C
- High ripple current capability
- Compact design
- SIKOREL design – storage for up to 15 years at a temperature of up to 35 °C
- RoHS-compatible

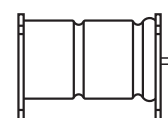
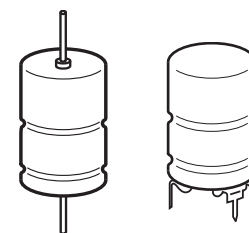

Construction

- Charge/discharge-proof, polar
- Aluminum case with PET insulating sleeve
- Negative pole connected to case
- Version without insulating sleeve available upon request

Terminals

- Axial leads, welded to capacitor case and cover disc
- Soldering star option for upright mounting on PCB or welding to busbar
- Alternative axial-lead design with double-sided plates for horizontal mounting available upon request

Taping and packing

- Axial-lead capacitors will be delivered in pallet package
Capacitors with $d \times l \leq 16 \times 39$ mm are also available taped on reel
- Soldering star capacitors are packed in blister trays

Specifications and characteristics in brief

Rated voltage V_R	25 ... 75 V DC							
Surge voltage V_S	$1.15 \cdot V_R$							
Rated capacitance C_R	360 ... 10000 μF							
Capacitance tolerance	–10/+30% \triangleq Q							
Leakage current I_{leak} (5 min, 20 °C)	$I_{\text{leak}} \leq 0.006 \mu\text{A} \cdot \left(\frac{C_R}{\mu\text{F}} \cdot \frac{V_R}{\text{V}} \right) + 4 \mu\text{A}$							
Self-inductance ESL ¹⁾	Diameter d (mm)	12	14	16	18	20	21	
	Terminals	Length l (mm)						Approx. ESL (nH)
	axial	25	–	22	26	30	–	–
		29	–	–	–	–	38	–
		30	21	24	29	34	–	39
		35	–	–	31	36	–	41
		39	–	–	33	38	–	45
	soldering star	49	–	–	–	–	–	50
		25	–	6	7	8	–	–
		30	6	7	8	10	–	11
35		–	–	9	10.5	–	12	
39		–	–	9	11	–	13	
49	–	–	–	–	–	14		
Useful life ²⁾ 140 °C; V_R ; $0.6 \cdot I_{AC,R}$ 125 °C; V_R ; $I_{AC, \text{max}}$ 125 °C; V_R ; $I_{AC, R}$	> 2000 h > 3000 h > 5000 h	Requirements: $ \Delta C/C \leq 30\%$ of initial value ESR ≤ 3 times initial specified limit ³⁾ $I_{\text{leak}} \leq$ initial specified limit						
Voltage endurance test 125 °C; V_R	2000 h	Post test requirements: $ \Delta C/C \leq 10\%$ of initial value ESR ≤ 1.3 times initial specified limit ³⁾ $I_{\text{leak}} \leq$ initial specified limit						
Vibration resistance test	To IEC 60068-2-6, test Fc: Frequency range 10 Hz ... 2 kHz, displacement amplitude max. 1.5 mm, acceleration max. 20 g, duration 3×2 h. Capacitor rigidly clamped by the aluminum case e.g. using our standard fixture.							
IEC climatic category	To IEC 60068-1: 55/125/56 (–55 °C/+125 °C/56 days damp heat test)							
Sectional specification	IEC 60384-4							
Reference standard	AEC-Q200 ⁴⁾							

1) If optimum circuit design is used, the values are lower by 30%.

2) Refer to chapter "General technical information, 5 Useful life" on how to interpret useful life.

3) ESR_{max} at 100 Hz, 20 °C

4) Refer to chapter "General technical information, 2.3 AEC-Q200 standard" for further details.



B41692, B41792

Compact – up to 140 °C

B41692, Axial-lead capacitors

Dimensional drawing

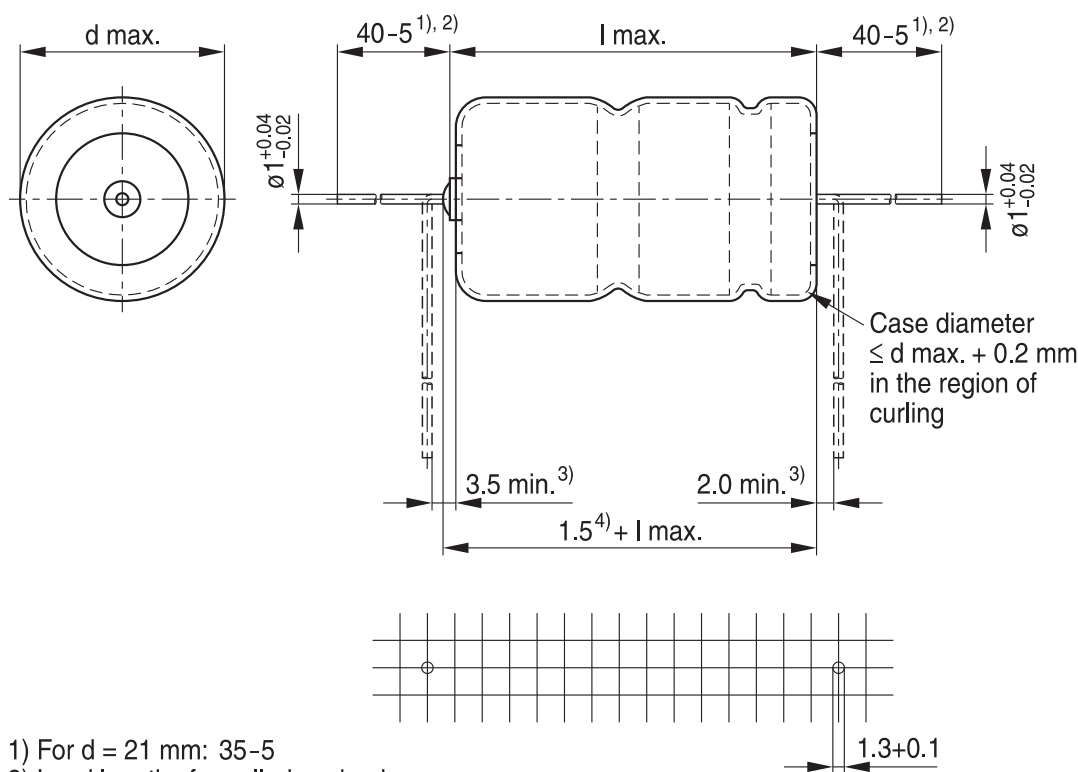

- 1) For d = 21 mm: 35-5
- 2) Lead lengths for palled packaging
- 3) Minimum bending distance recommended per wire
- 4) Maximum length of welding projection

KAL1749-V-E

Dimensions, weights and packing units

d × l mm	d _{max} × l _{max} mm	Approx. weight g	Packing units (pcs.)	
			Pallet	Reel
12 × 30	12.5 × 30.5	5.1	288	450
14 × 25	14.5 × 25.5	5.7	200	350
14 × 30	14.5 × 30.5	6.8	200	350
16 × 25	16.5 × 25.5	7.4	180	250
16 × 30	16.5 × 30.5	8.9	180	250
16 × 35	16.5 × 35.5	10.4	180	250
16 × 39	16.5 × 40	11.7	180	250
18 × 25	18.5 × 25.5	9.3	160	—
18 × 30	18.5 × 30.5	11.1	160	—
18 × 35	18.5 × 35.5	12.8	160	—
18 × 39	18.5 × 40	14.7	160	—
20 × 29	20.5 × 29.5	13.5	140	—
21 × 30	21.5 × 30.5	16.5	140	—
21 × 35	21.5 × 35.5	17.0	140	—
21 × 39	21.5 × 40	20.0	140	—
21 × 49	21.5 × 50	25.0	110	—

B41792, Soldering star capacitors
Dimensional drawings

 Mounting holes $d = 12 \text{ mm} \dots 14 \text{ mm}$

 Mounting holes $d = 16 \text{ mm} \dots 21 \text{ mm}$

Dimensions, weights and packing units

$d \times l$ mm	$d_{\max} \times l_{\max}$ mm	$c \pm 0.1$ mm	$e \pm 0.1$ mm	Approx. weight g	Packing units pcs.
12 × 30	13.5 × 32	12.5	3.0	5.4	480
14 × 25	15.5 × 27	14.5	3.0	6.1	480
14 × 30	15.5 × 32	14.5	3.0	7.2	480
16 × 25	17.5 × 27	16.5	3.0	7.9	300
16 × 30	17.5 × 32	16.5	3.0	9.4	300
16 × 35	17.5 × 37	16.5	3.0	10.9	200
16 × 39	17.5 × 41.5	16.5	3.0	12.2	200
18 × 25	19.5 × 27	18.5	3.0	9.9	300
18 × 30	19.5 × 32	18.5	3.0	11.8	300
18 × 35	19.5 × 37	18.5	3.0	13.2	200
18 × 39	19.5 × 41.5	18.5	3.0	15.4	200
21 × 30	22.5 × 32.0	21.5	3.5	17.1	468
21 × 35	22.5 × 37.0	21.5	3.5	18.3	324
21 × 39	22.5 × 41.5	21.5	3.5	21.0	324
21 × 49	22.5 × 51.5	21.5	3.5	26.0	264



B41692, B41792

Compact – up to 140 °C

Overview of available types

V_R (V DC)	25	40	63	75
	Case dimensions $d \times l$ (mm)			
C_R (μ F)				
360			12 × 30	
430			14 × 25	
560			14 × 30	
620		12 × 30	16 × 25	
680				18 × 25
750			18 × 25	
820			16 × 30	
910				18 × 30
1000		14 × 30	16 × 35 18 × 30	
1100	12 × 30			18 × 35
1200			16 × 39	21 × 30
1300	14 × 25		18 × 35	18 × 39
1400		16 × 30	21 × 30	
1500			18 × 39	21 × 35
1800		16 × 35 18 × 30	21 × 35	21 × 39
2000		16 × 39	21 × 39	
2400	18 × 25	20 × 29		
2500	16 × 30			21 × 49
2600		18 × 39		
2700			21 × 49	
3300	18 × 30			
3600	16 × 39			
3900		21 × 39		
4300	20 × 29			
4700	18 × 39			
5100		21 × 49		
7200	21 × 39			
10000	21 × 49			

Case dimensions and ordering codes

C_R 100 Hz 20 °C μF	Case dimensions $d \times l$ mm	Ordering code Axial pallet	Ordering code Axial reel	Ordering code Soldering star
$V_R = 25 \text{ V DC}$				
1100	12 × 30	B41692C5118Q001	B41692C5118Q003	B41792C5118Q001
1300	14 × 25	B41692C5138Q001	B41692C5138Q003	B41792C5138Q001
2400	18 × 25	B41692C5248Q001		B41792C5248Q001
2500	16 × 30	B41692C5258Q001	B41692C5258Q003	B41792C5258Q001
3300	18 × 30	B41692C5338Q001		B41792C5338Q001
3600	16 × 39	B41692C5368Q001	B41692C5368Q003	B41792C5368Q001
4300	20 × 29	B41692C5438Q001		
4700	18 × 39	B41692C5478Q001		B41792C5478Q001
7200	21 × 39	B41692C5728Q001		B41792C5728Q001
10000	21 × 49	B41692C5109Q001		B41792C5109Q001
$V_R = 40 \text{ V DC}$				
620	12 × 30	B41692C7627Q001	B41692C7627Q003	B41792C7627Q001
1000	14 × 30	B41692C7108Q001	B41692C7108Q003	B41792C7108Q001
1400	16 × 30	B41692C7148Q001	B41692C7148Q003	B41792C7148Q001
1800	16 × 35	B41692C7188Q001	B41692C7188Q003	B41792C7188Q001
1800	18 × 30	B41692D7188Q001		B41792D7188Q001
2000	16 × 39	B41692C7208Q001	B41692C7208Q003	B41792C7208Q001
2400	20 × 29	B41692C7248Q001		
2600	18 × 39	B41692C7268Q001		B41792C7268Q001
3900	21 × 39	B41692C7398Q001		B41792C7398Q001
5100	21 × 49	B41692C7518Q001		B41792C7518Q001
$V_R = 63 \text{ V DC}$				
360	12 × 30	B41692D8367Q001	B41692D8367Q003	B41792D8367Q001
430	14 × 25	B41692D8437Q001	B41692D8437Q003	B41792D8437Q001
560	14 × 30	B41692D8567Q001	B41692D8567Q003	B41792D8567Q001
620	16 × 25	B41692D8627Q001	B41692D8627Q003	B41792D8627Q001
750	18 × 25	B41692D8757Q001		B41792D8757Q001
820	16 × 30	B41692D8827Q001	B41692D8827Q003	
1000	16 × 35	B41692D8108Q001	B41692D8108Q003	B41792D8108Q001
1000	18 × 30	B41692E8108Q001		B41792E8108Q001
1200	16 × 39	B41692D8128Q001	B41692D8128Q003	B41792D8128Q001
1300	18 × 35	B41692D8138Q001		B41792D8138Q001
1400	21 × 30	B41692D8148Q001		B41792D8148Q001
1500	18 × 39	B41692D8158Q001		B41792D8158Q001
1800	21 × 35	B41692D8188Q001		B41792D8188Q001
2000	21 × 39	B41692D8208Q001		B41792D8208Q001
2700	21 × 49	B41692D8278Q001		B41792D8278Q001



B41692, B41792

Compact – up to 140 °C

Case dimensions and ordering codes

C_R 100 Hz 20 °C μF	Case dimensions $d \times l$ mm	Ordering code Axial pallet	Ordering code Axial reel	Ordering code Soldering star
$V_R = 75 \text{ V DC}$				
680	18 × 25	B41692D0687Q001		B41792D0687Q001
910	18 × 30	B41692D0917Q001		B41792D0917Q001
1100	18 × 35	B41692D0118Q001		B41792D0118Q001
1200	21 × 30	B41692D0128Q001		B41792D0128Q001
1300	18 × 39	B41692D0138Q001		B41792D0138Q001
1500	21 × 35	B41692D0158Q001		B41792D0158Q001
1800	21 × 39	B41692D0188Q001		B41792D0188Q001
2500	21 × 49	B41692D0258Q001		B41792D0258Q001

Technical data

C_R 100 Hz 20 °C μF	Case dimensions $d \times l$ mm	ESR_{max} 100 Hz 20 °C m Ω	ESR_{max} 100 Hz -40 °C m Ω	ESR_{max} 10 kHz 20 °C m Ω	Z_{max} 100 kHz 20 °C m Ω	$I_{\text{AC,max}}$ 10 kHz 105 °C A	$I_{\text{AC,max}}$ 10 kHz 125 °C A	$I_{\text{AC,R}}$ 10 kHz 125 °C A	$I_{\text{AC,max}}$ 10 kHz 140 °C A
$V_R = 25 \text{ V DC}$									
1100	12 × 30	163	1230	114	110	4.6	3.4	2.3	1.5
1300	14 × 25	145	1040	103	100	4.5	3.3	2.3	1.5
2400	18 × 25	78	570	55	54	7.0	5.2	3.6	2.3
2500	16 × 30	84	550	61	59	6.2	4.6	3.2	2.1
3300	18 × 30	58	410	41	40	8.7	6.5	4.5	2.9
3600	16 × 39	59	380	43	42	8.3	6.2	4.3	2.8
4300	20 × 29	47	320	34	33	9.4	7.0	4.8	3.1
4700	18 × 39	41	290	29	29	11.7	8.7	6.0	3.9
7200	21 × 39	30	190	22	22	13.2	9.8	6.8	4.4
10000	21 × 49	23	140	17	16	16.7	12.4	8.6	5.6
$V_R = 40 \text{ V DC}$									
620	12 × 30	189	1200	110	107	4.6	3.4	2.4	1.5
1000	14 × 30	124	750	75	72	5.6	4.2	2.9	1.9
1400	16 × 30	96	540	60	58	6.2	4.6	3.2	2.1
1800	16 × 35	76	420	48	46	7.4	5.5	3.8	2.5
1800	18 × 30	68	420	41	40	8.7	6.5	4.5	2.9
2000	16 × 39	68	380	43	41	8.3	6.2	4.3	2.8
2400	20 × 29	54	320	34	33	9.4	7.0	4.8	3.1
2600	18 × 39	48	290	29	28	11.7	8.7	6.0	3.9
3900	21 × 39	35	200	22	22	13.2	9.8	6.8	4.4
5100	21 × 49	27	150	17	17	16.7	12.4	8.6	5.6
$V_R = 63 \text{ V DC}$									
360	12 × 30	243.0	1500	115.0	111.0	4.5	3.4	2.3	1.5
430	14 × 25	212.0	1260	104.0	101.0	4.4	3.2	2.2	1.5
560	14 × 30	163.0	965	79.6	77.2	5.5	4.0	2.8	1.8
620	16 × 25	158.0	878	81.7	79.2	4.8	3.6	2.5	1.6
750	18 × 25	120.0	720	57.9	56.2	6.8	5.0	3.5	2.3
820	16 × 30	120.0	665	62.1	60.2	6.0	4.5	3.1	2.0
1000	16 × 35	97.9	545	50.8	49.3	7.2	5.4	3.7	2.4
1000	18 × 30	90.2	540	43.8	42.5	8.5	6.3	4.3	2.8
1200	16 × 39	82.3	455	43.0	41.7	8.2	6.1	4.2	2.7
1300	18 × 35	70.1	416	34.3	33.3	10.1	7.6	5.2	3.4
1400	21 × 30	68.0	388	34.5	33.5	9.6	7.1	4.9	3.2
1500	18 × 39	60.8	361	29.8	28.9	11.5	8.6	5.9	3.8
1800	21 × 35	53.5	302	27.4	26.6	11.4	8.5	5.9	3.8
2000	21 × 39	47.8	272	24.4	23.6	12.9	9.6	6.6	4.3
2700	21 × 49	35.9	202	18.5	17.9	16.3	12.2	8.4	5.5

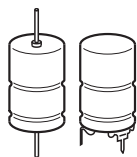

B41692, B41792

Compact – up to 140 °C

Technical data

C_R 100 Hz 20 °C μF	Case dimensions $d \times l$ mm	ESR_{max} 100 Hz 20 °C m Ω	ESR_{max} 100 Hz –40 °C m Ω	ESR_{max} 10 kHz 20 °C m Ω	Z_{max} 100 kHz 20 °C m Ω	$I_{\text{AC,max}}$ 10 kHz 105 °C A	$I_{\text{AC,max}}$ 10 kHz 125 °C A	$I_{\text{AC,R}}$ 10 kHz 125 °C A	$I_{\text{AC,max}}$ 10 kHz 140 °C A
$V_R = 75 \text{ V DC}$									
680	18 × 25	133	971	65	63	6.2	4.6	3.1	1.9
910	18 × 30	100	726	49	47	8.0	6.0	4.1	2.5
1100	18 × 35	83	600	40	39	10.1	7.6	5.2	3.1
1200	21 × 30	77	551	38	37	9.6	7.1	4.9	2.9
1300	18 × 39	70	508	34	33	11.5	8.6	5.9	3.5
1500	21 × 35	62	441	31	30	11.5	8.6	5.9	3.5
1800	21 × 39	52	368	26	25	12.9	9.6	6.6	4.0
2500	21 × 49	38	265	19	19	16.4	12.2	8.4	5.0



Useful life¹⁾

depending on ambient temperature T_A under ripple current operating conditions at V_R

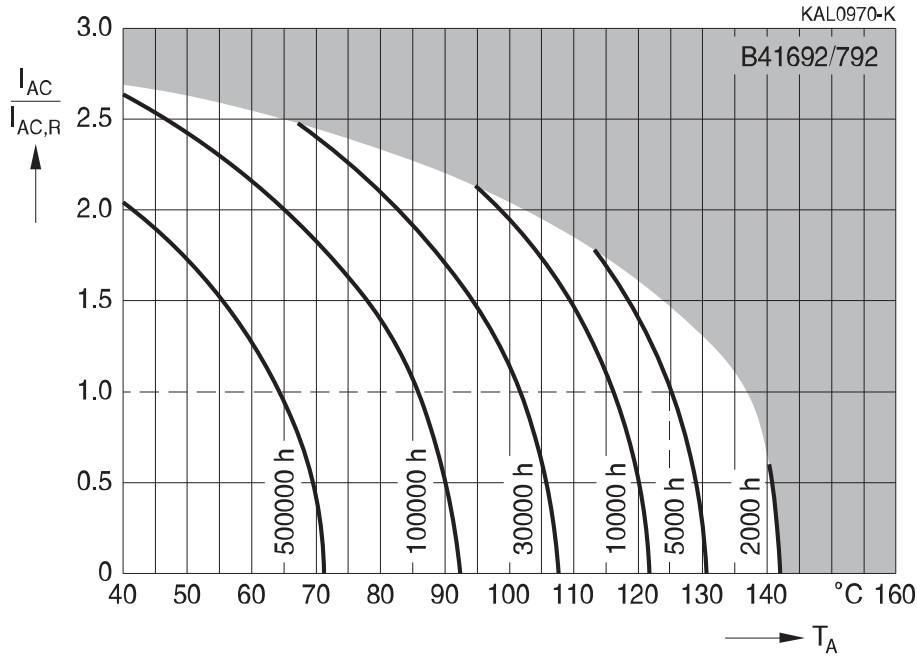

Useful life¹⁾

depending on case temperature T_C under ripple current operating conditions at V_R

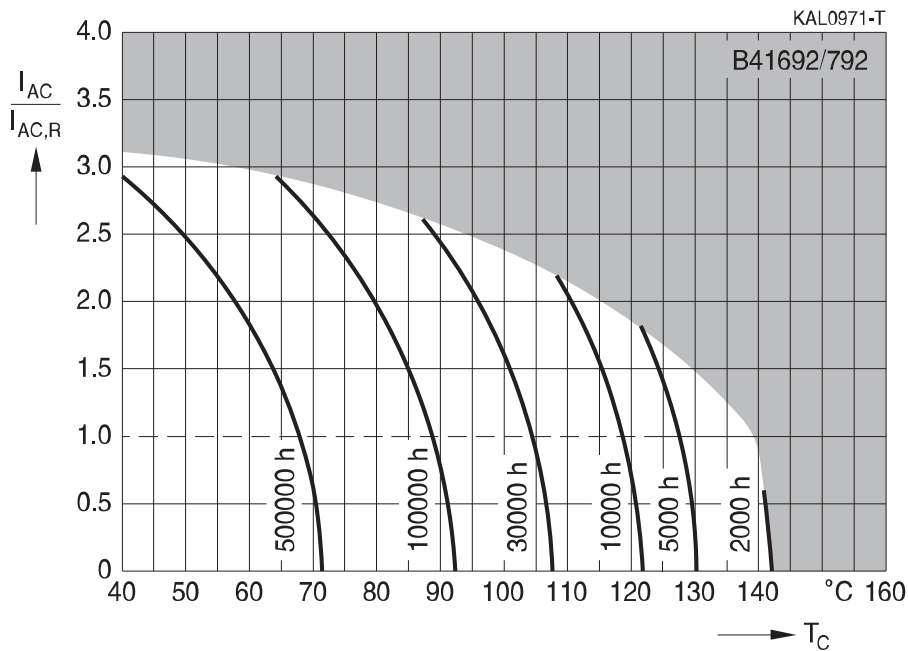

1) Refer to chapter "General technical information, 5 Useful life" on how to interpret useful life.



B41692, B41792

Compact – up to 140 °C

Frequency factor of permissible ripple current I_{AC} versus frequency f



**Frequency characteristics of ESR
Typical behavior**



Equivalent series resistance ESR versus frequency f

Typical behavior for 2400 μ F/25 V

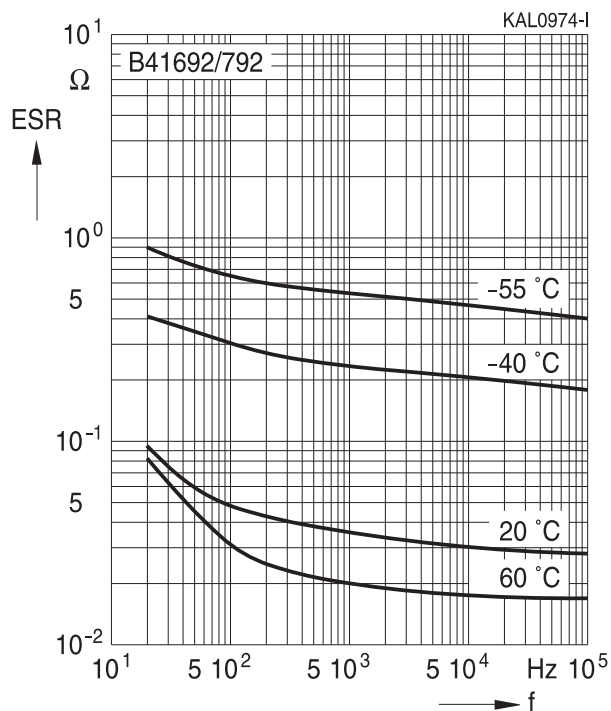

Impedance Z versus frequency f

Typical behavior for 2400 μ F/25 V

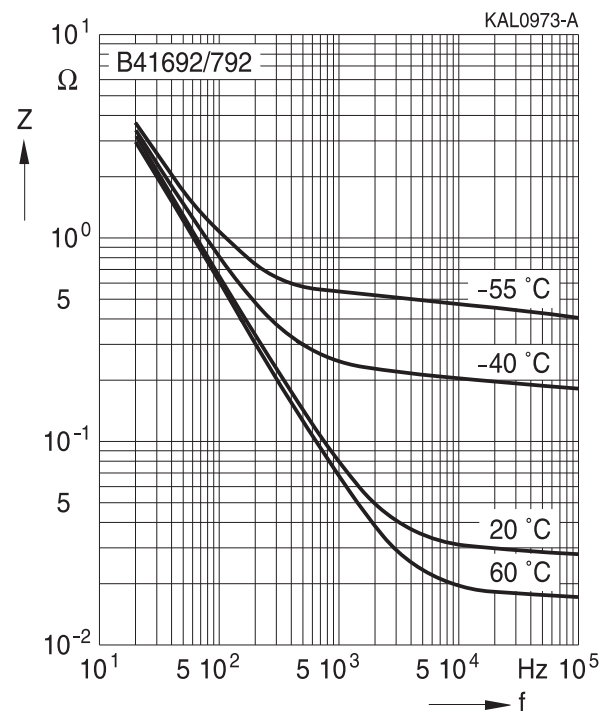



Cautions and warnings

Personal safety

The electrolytes used have been optimized both with a view to the intended application and with regard to health and environmental compatibility. They do not contain any solvents that are detrimental to health, e.g. dimethyl formamide (DMF) or dimethyl acetamide (DMAC). Furthermore, some of the high-voltage electrolytes used are self-extinguishing.

As far as possible, we do not use any dangerous chemicals or compounds to produce operating electrolytes, although in exceptional cases, such materials must be used in order to achieve specific physical and electrical properties because no alternative materials are currently known. We do, however, restrict the amount of dangerous materials used in our products to an absolute minimum.

Materials and chemicals used in our aluminum electrolytic capacitors are continuously adapted in compliance with the TDK Electronics Corporate Environmental Policy and the latest EU regulations and guidelines such as RoHS, REACH/SVHC, GADSL, and ELV.

MDS (Material Data Sheets) are available on our website for all types listed in the data book. MDS for customer specific capacitors are available upon request.

MSDS (Material Safety Data Sheets) are available for our electrolytes upon request.

Nevertheless, the following rules should be observed when handling aluminum electrolytic capacitors: No electrolyte should come into contact with eyes or skin. If electrolyte does come into contact with the skin, wash the affected areas immediately with running water. If the eyes are affected, rinse them for 10 minutes with plenty of water. If symptoms persist, seek medical treatment. Avoid inhaling electrolyte vapor or mists. Workplaces and other affected areas should be well ventilated. Clothing that has been contaminated by electrolyte must be changed and rinsed in water.

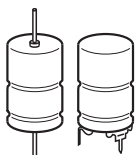

B41692, B41792

Compact – up to 140 °C

Product safety

The table below summarizes the safety instructions that must be observed without fail. A detailed description can be found in the relevant sections of separate file chapter "General technical information".

Topic	Safety information	Reference chapter "General technical information"
Polarity	Make sure that polar capacitors are connected with the right polarity.	1 "Basic construction of aluminum electrolytic capacitors"
Reverse voltage	Voltages of opposite polarity should be prevented by connecting a diode.	3.1.6 "Reverse voltage"
Mounting position of screw-terminal capacitors	Screw terminal capacitors must not be mounted with terminals facing down unless otherwise specified.	11.1. "Mounting positions of capacitors with screw terminals"
Robustness of terminals	The following maximum tightening torques must not be exceeded when connecting screw terminals: M5: 2.5 Nm M6: 4.0 Nm	11.3 "Mounting torques"
Mounting of single-ended capacitors	The internal structure of single-ended capacitors might be damaged if excessive force is applied to the lead wires. Avoid any compressive, tensile or flexural stress. Do not move the capacitor after soldering to PC board. Do not pick up the PC board by the soldered capacitor. Do not insert the capacitor on the PC board with a hole space different to the lead space specified.	11.4 "Mounting considerations for single-ended capacitors"
Soldering	Do not exceed the specified time or temperature limits during soldering.	11.5 "Soldering"
Soldering, cleaning agents	Do not allow halogenated hydrocarbons to come into contact with aluminum electrolytic capacitors.	11.6 "Cleaning agents"
Upper category temperature	Do not exceed the upper category temperature.	7.2 "Maximum permissible operating temperature"
Passive flammability	Avoid external energy, e.g. fire.	8.1 "Passive flammability"



Topic	Safety information	Reference chapter "General technical information"
Active flammability	Avoid overload of the capacitors.	8.2 "Active flammability"
Maintenance	Make periodic inspections of the capacitors. Before the inspection, make sure that the power supply is turned off and carefully discharge the capacitors. Do not apply excessive mechanical stress to the capacitor terminals when mounting.	10 "Maintenance"
Storage	Do not store capacitors at high temperatures or high humidity. Capacitors should be stored at +5 to +35 °C and a relative humidity of ≤ 75%.	7.3 "Shelf life and storage conditions"
		Reference chapter "Capacitors with screw terminals"
Breakdown strength of insulating sleeves	Do not damage the insulating sleeve, especially when ring clips are used for mounting.	"Screw terminals – accessories"

Display of ordering codes for TDK Electronics products

The ordering code for one and the same product can be represented differently in data sheets, data books, other publications, on the company website, or in order-related documents such as shipping notes, order confirmations and product labels. The varying representations of the ordering codes are due to different processes employed and do not affect the specifications of the respective products.

Detailed information can be found on the Internet under www.tdk-electronics.tdk.com/orderingcodes.



B41692, B41792

Compact – up to 140 °C

Symbols and terms

Symbol	English	German
C	Capacitance	Kapazität
C_R	Rated capacitance	Nennkapazität
C_S	Series capacitance	Serienkapazität
$C_{S,T}$	Series capacitance at temperature T	Serienkapazität bei Temperatur T
C_f	Capacitance at frequency f	Kapazität bei Frequenz f
d	Case diameter, nominal dimension	Gehäusedurchmesser, Nennmaß
d_{max}	Maximum case diameter	Maximaler Gehäusedurchmesser
ESL	Self-inductance	Eigeninduktivität
ESR	Equivalent series resistance	Ersatzserienwiderstand
ESR_f	Equivalent series resistance at frequency f	Ersatzserienwiderstand bei Frequenz f
ESR_T	Equivalent series resistance at temperature T	Ersatzserienwiderstand bei Temperatur T
f	Frequency	Frequenz
I	Current	Strom
I_{AC}	Alternating current (ripple current)	Wechselstrom
$I_{AC,RMS}$	Root-mean-square value of alternating current	Wechselstrom, Effektivwert
$I_{AC,f}$	Ripple current at frequency f	Wechselstrom bei Frequenz f
$I_{AC,max}$	Maximum permissible ripple current	Maximal zulässiger Wechselstrom
$I_{AC,R}$	Rated ripple current	Nennwechselstrom
I_{leak}	Leakage current	Reststrom
$I_{leak,op}$	Operating leakage current	Betriebsreststrom
l	Case length, nominal dimension	Gehäuselänge, Nennmaß
l_{max}	Maximum case length (without terminals and mounting stud)	Maximale Gehäuselänge (ohne Anschlüsse und Gewindebolzen)
R	Resistance	Widerstand
R_{ins}	Insulation resistance	Isolationswiderstand
R_{symm}	Balancing resistance	Symmetrierwiderstand
T	Temperature	Temperatur
ΔT	Temperature difference	Temperaturdifferenz
T_A	Ambient temperature	Umgebungstemperatur
T_C	Case temperature	Gehäusetemperatur
T_B	Capacitor base temperature	Temperatur des Gehäusebodens
t	Time	Zeit
Δt	Period	Zeitraum
t_b	Service life (operating hours)	Brauchbarkeitsdauer (Betriebszeit)

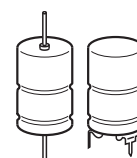

Symbol	English	German
V	Voltage	Spannung
V_F	Forming voltage	Formierspannung
V_{op}	Operating voltage	Betriebsspannung
V_R	Rated voltage, DC voltage	Nennspannung, Gleichspannung
V_S	Surge voltage	Spitzenspannung
X_C	Capacitive reactance	Kapazitiver Blindwiderstand
X_L	Inductive reactance	Induktiver Blindwiderstand
Z	Impedance	Scheinwiderstand
Z_T	Impedance at temperature T	Scheinwiderstand bei Temperatur T
$\tan \delta$	Dissipation factor	Verlustfaktor
λ	Failure rate	Ausfallrate
ϵ_0	Absolute permittivity	Elektrische Feldkonstante
ϵ_r	Relative permittivity	Dielektrizitätszahl
ω	Angular velocity; $2 \cdot \pi \cdot f$	Kreisfrequenz; $2 \cdot \pi \cdot f$

Note

All dimensions are given in mm.

Important notes

The following applies to all products named in this publication:

1. Some parts of this publication contain **statements about the suitability of our products for certain areas of application**. These statements are based on our knowledge of typical requirements that are often placed on our products in the areas of application concerned. We nevertheless expressly point out **that such statements cannot be regarded as binding statements about the suitability of our products for a particular customer application**. As a rule, we are either unfamiliar with individual customer applications or less familiar with them than the customers themselves. For these reasons, it is always ultimately incumbent on the customer to check and decide whether a product with the properties described in the product specification is suitable for use in a particular customer application.
2. We also point out that **in individual cases, a malfunction of electronic components or failure before the end of their usual service life cannot be completely ruled out in the current state of the art, even if they are operated as specified**. In customer applications requiring a very high level of operational safety and especially in customer applications in which the malfunction or failure of an electronic component could endanger human life or health (e.g. in accident prevention or lifesaving systems), it must therefore be ensured by means of suitable design of the customer application or other action taken by the customer (e.g. installation of protective circuitry or redundancy) that no injury or damage is sustained by third parties in the event of malfunction or failure of an electronic component.
3. **The warnings, cautions and product-specific notes must be observed.**
4. In order to satisfy certain technical requirements, **some of the products described in this publication may contain substances subject to restrictions in certain jurisdictions (e.g. because they are classed as hazardous)**. Useful information on this will be found in our Material Data Sheets on the Internet (www.tdk-electronics.tdk.com/material). Should you have any more detailed questions, please contact our sales offices.
5. We constantly strive to improve our products. Consequently, **the products described in this publication may change from time to time**. The same is true of the corresponding product specifications. Please check therefore to what extent product descriptions and specifications contained in this publication are still applicable before or when you place an order. We also **reserve the right to discontinue production and delivery of products**. Consequently, we cannot guarantee that all products named in this publication will always be available. The aforementioned does not apply in the case of individual agreements deviating from the foregoing for customer-specific products.
6. Unless otherwise agreed in individual contracts, **all orders are subject to our General Terms and Conditions of Supply**.

Important notes

7. **Our manufacturing sites serving the automotive business apply the IATF 16949 standard.** The IATF certifications confirm our compliance with requirements regarding the quality management system in the automotive industry. Referring to customer requirements and customer specific requirements (“CSR”) TDK always has and will continue to have the policy of respecting individual agreements. Even if IATF 16949 may appear to support the acceptance of unilateral requirements, we hereby like to emphasize that **only requirements mutually agreed upon can and will be implemented in our Quality Management System.** For clarification purposes we like to point out that obligations from IATF 16949 shall only become legally binding if individually agreed upon.
8. The trade names EPCOS, CeraCharge, CeraDiode, CeraLink, CeraPad, CeraPlas, CSMP, CTVS, DeltaCap, DigiSiMic, ExoCore, FilterCap, FormFit, LeaXield, MiniBlue, MiniCell, MKD, MKK, MotorCap, PCC, PhaseCap, PhaseCube, PhaseMod, PhiCap, PowerHap, PQSine, PQvar, SIFERRIT, SIFI, SIKOREL, SilverCap, SIMDAD, SiMic, SIMID, SineFormer, SIOV, ThermoFuse, WindCap are **trademarks registered or pending** in Europe and in other countries. Further information will be found on the Internet at www.tdk-electronics.tdk.com/trademarks.

Release 2018-10

Mouser Electronics

Authorized Distributor

Click to View Pricing, Inventory, Delivery & Lifecycle Information:

EPCOS / TDK:

[B41792A5687Q000](#) [B41792A5108Q000](#) [B41792A5158Q000](#) [B41792A5228Q000](#) [B41792B5228Q000](#)
[B41792A5338Q000](#) [B41792A7477Q000](#) [B41792A7687Q000](#) [B41792A7108Q000](#) [B41792A7158Q000](#)
[B41792B7158Q000](#) [B41792A7228Q000](#) [B41792A8227Q000](#) [B41792A8337Q000](#) [B41792A8477Q000](#)
[B41792A8687Q000](#) [B41792B8687Q000](#) [B41792A8108Q000](#) [B41792D8367Q001](#) [B41792A5687Q001](#)
[B41792B7158Q001](#) [B41792A5338Q001](#) [B41692C7208Q001](#)



Стандарт Электрон Связь

Мы молодая и активно развивающаяся компания в области поставок электронных компонентов. Мы поставляем электронные компоненты отечественного и импортного производства напрямую от производителей и с крупнейших складов мира.

Благодаря сотрудничеству с мировыми поставщиками мы осуществляем комплексные и плановые поставки широчайшего спектра электронных компонентов.

Собственная эффективная логистика и склад в обеспечивает надежную поставку продукции в точно указанные сроки по всей России.

Мы осуществляем техническую поддержку нашим клиентам и предпродажную проверку качества продукции. На все поставляемые продукты мы предоставляем гарантию .

Осуществляем поставки продукции под контролем ВП МО РФ на предприятия военно-промышленного комплекса России , а также работаем в рамках 275 ФЗ с открытием отдельных счетов в уполномоченном банке. Система менеджмента качества компании соответствует требованиям ГОСТ ISO 9001.

Минимальные сроки поставки, гибкие цены, неограниченный ассортимент и индивидуальный подход к клиентам являются основой для выстраивания долгосрочного и эффективного сотрудничества с предприятиями радиоэлектронной промышленности, предприятиями ВПК и научно-исследовательскими институтами России.

С нами вы становитесь еще успешнее!

Наши контакты:

Телефон: +7 812 627 14 35

Электронная почта: sales@st-electron.ru

Адрес: 198099, Санкт-Петербург,
Промышленная ул, дом № 19, литера Н,
помещение 100-Н Офис 331