

2N3904

NPN General Purpose Amplifier

Features

- Lead Free Finish/RoHS Compliant ("P" Suffix designates RoHS Compliant. See ordering information)
- € Capable of 625mW of Power Dissipation and 200mA I_c
- € Epoxy meets UL 94 V-0 flammability rating
- € Moisture Sensitivity Level 1
- € Through Hole Package
- € Halogen free available upon request by adding suffix "-HF"
- Operating Temperature: -55°C to +150°C
- Storage Temperature: -55°C to +150°C

Electrical Characteristics @ 25°C Unless Otherwise Specified

Symbol	Parameter	Min	Max	Units
OFF CHARACTERISTICS				
V _{(BR)CEO}	Collector-Emitter Breakdown Voltage* (I _C =1.0mA, I _B =0)	40		Vdc
V _{(BR)CBO}	Collector-Base Breakdown Voltage (I _C =10μA, I _E =0)	60		Vdc
V _{(BR)EBO}	Emitter-Base Breakdown Voltage (I _E =10μA, I _C =0)	6.0		Vdc
I _{BL}	Base Cutoff Current (V _{CE} =30Vdc, V _{BE} =3.0Vdc)		50	nA
I _{CEX}	Collector Cutoff Current (V _{CE} =30Vdc, V _{BE} =3.0Vdc)		50	nA

ON CHARACTERISTICS

h _{FE}	DC Current Gain* (I _C =0.1mA, V _{CE} =1.0Vdc) (I _C =1.0mA, V _{CE} =1.0Vdc) (I _C =10mA, V _{CE} =1.0Vdc) (I _C =50mA, V _{CE} =1.0Vdc) (I _C =100mA, V _{CE} =1.0Vdc)	40 70 100 60 30	300	
V _{CE(sat)}	Collector-Emitter Saturation Voltage (I _C =10mA, I _B =1.0mA) (I _C =50mA, I _B =5.0mA)		0.2 0.4	Vdc
V _{BE(sat)}	Base-Emitter Saturation Voltage (I _C =10mA, I _B =1.0mA) (I _C =50mA, I _B =5.0mA)	0.65	0.85 0.95	Vdc

SMALL-SIGNAL CHARACTERISTICS

f _T	Current Gain-Bandwidth Product (I _C =10mA, V _{CE} =20Vdc, f=100MHz)	250		MHz
C _{obo}	Output Capacitance (V _{CB} =5.0Vdc, I _E =0, f=1.0MHz)		4.0	pF
C _{ibo}	Input Capacitance (V _{BE} =0.5Vdc, I _C =0, f=1.0MHz)		8.0	pF
NF	Noise Figure (I _C =100μA, V _{CE} =5.0Vdc, R _S =1.0kΩ f=10Hz to 15.7kHz)		5.0	dB

SWITCHING CHARACTERISTICS

t _d	Delay Time	(V _{CC} =3.0Vdc, V _{BE} =0.5Vdc)	35	ns
t _r	Rise Time	(I _C =10mA, I _{B1} =1.0mA)	35	ns
t _s	Storage Time	(V _{CC} =3.0Vdc, I _C =10mA)	200	ns
t _f	Fall Time	(I _{B1} =I _{B2} =1.0mA)	50	ns

*Pulse Width ≤ 300μs, Duty Cycle ≤ 2.0%

Symbol	Characteristic	Max	Unit
R _{θJA}	Thermal Resistance, Junction-to-Ambient	200	°C/W

TO-92

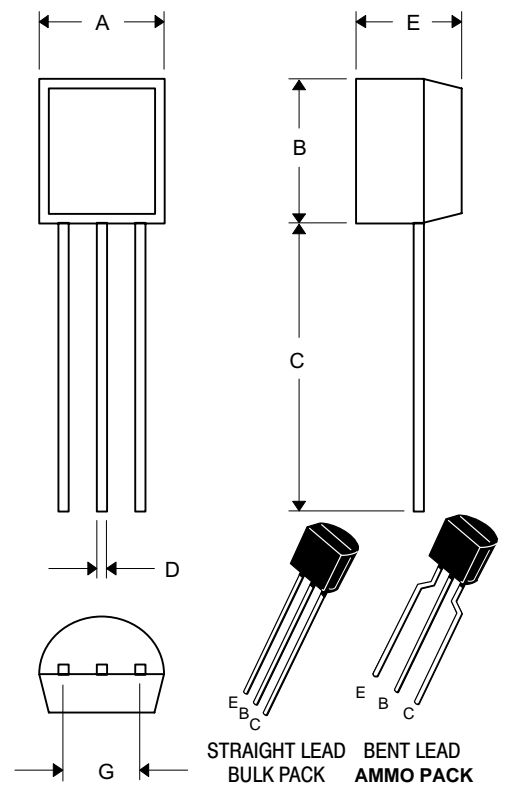

DIMENSIONS

DIM	INCHES		MM		NOTE
	MIN	MAX	MIN	MAX	
A	.175	.185	4.45	4.70	
B	.175	.185	4.45	4.70	
C	.500	---	12.70	---	
D	.016	.020	0.41	0.63	
E	.135	.145	3.43	3.68	
G	.095	.105	2.42	2.67	Straight Lead
	.173	.220	4.40	5.60	Bent Lead

* For ammo packing detailed specification, click here to visit our website of product packaging for details.

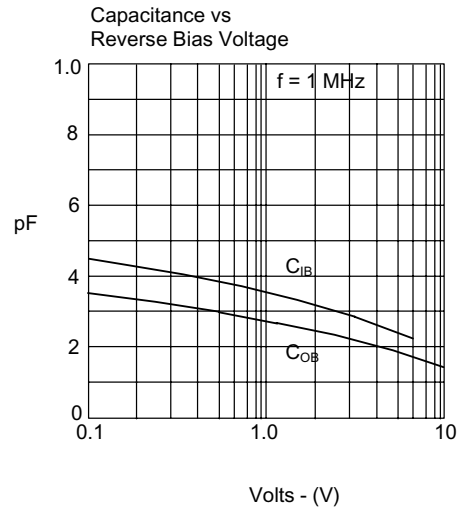
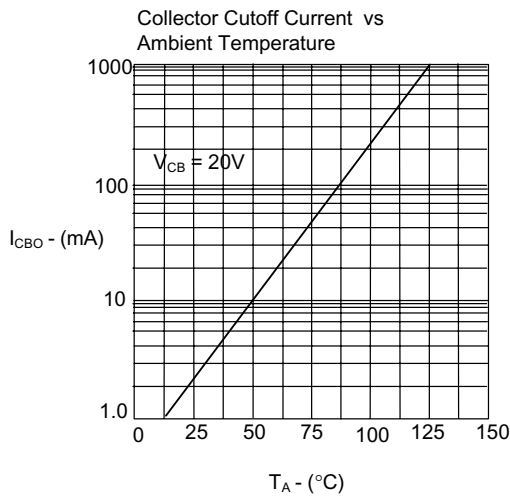
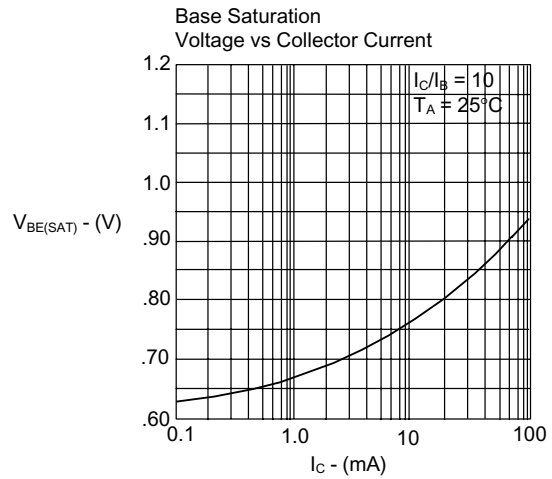
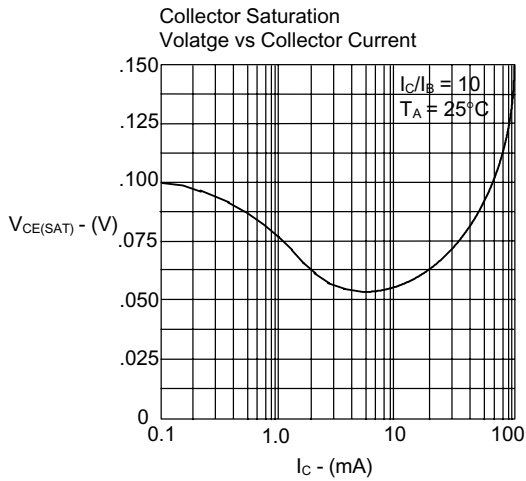
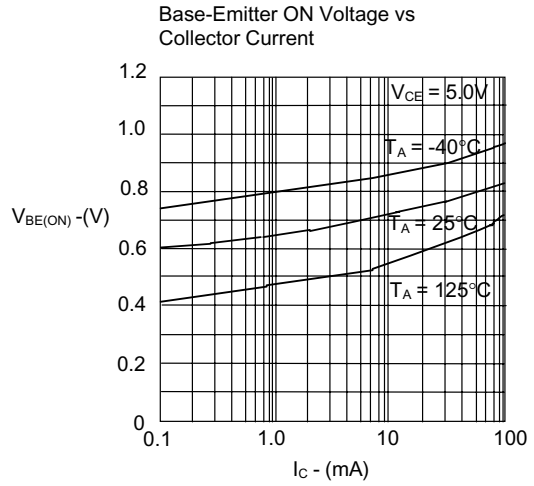
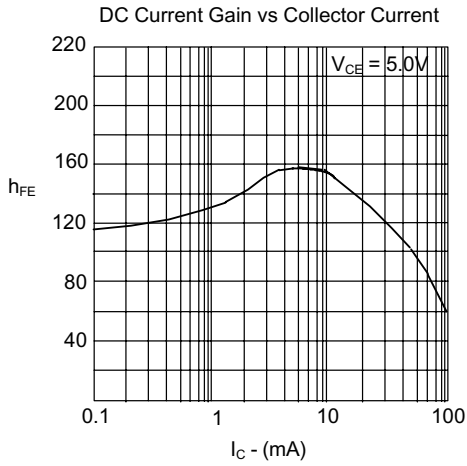

2N3904

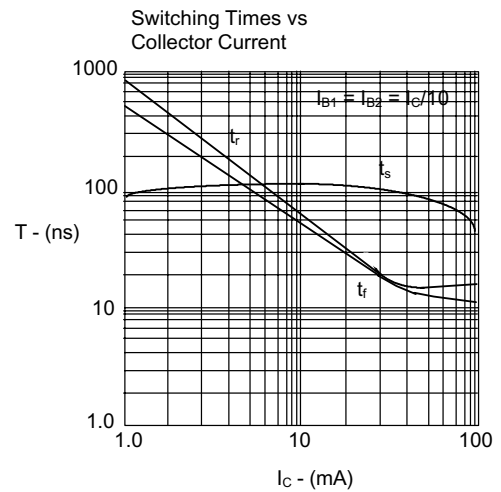
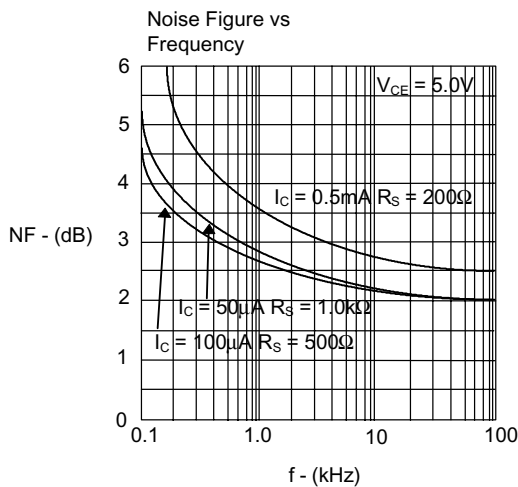
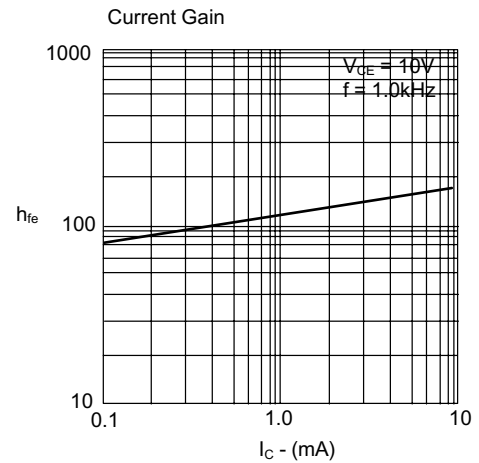
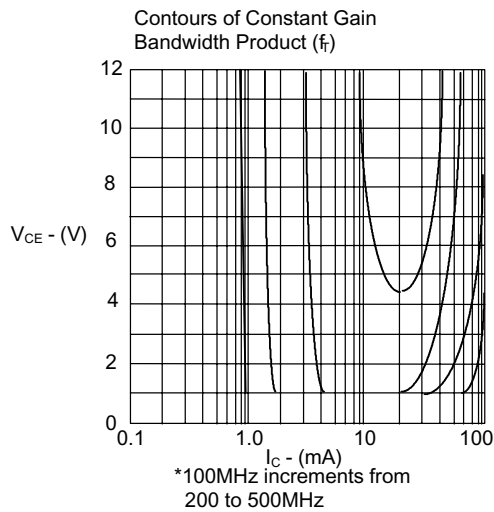
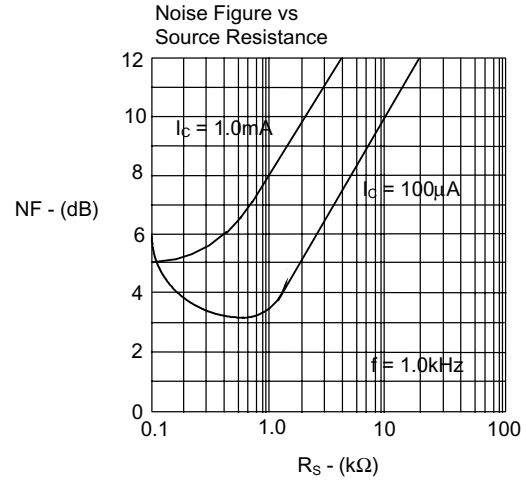
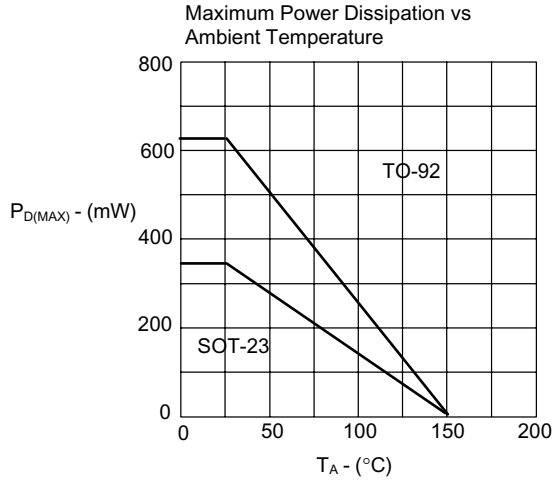

2N3904

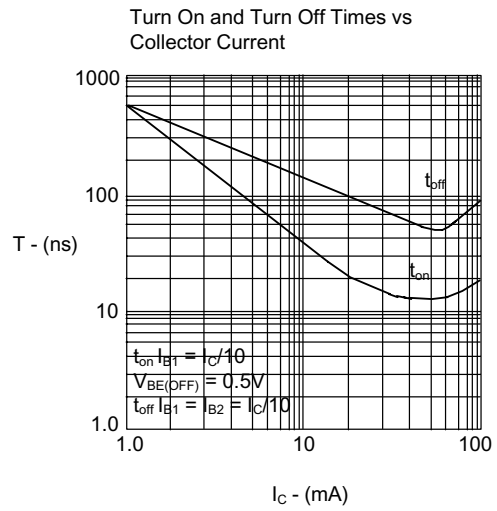
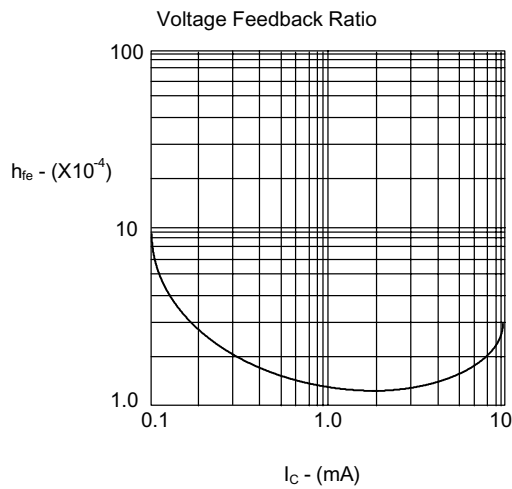
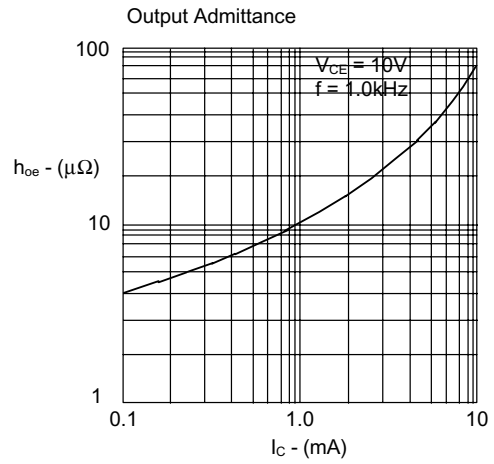
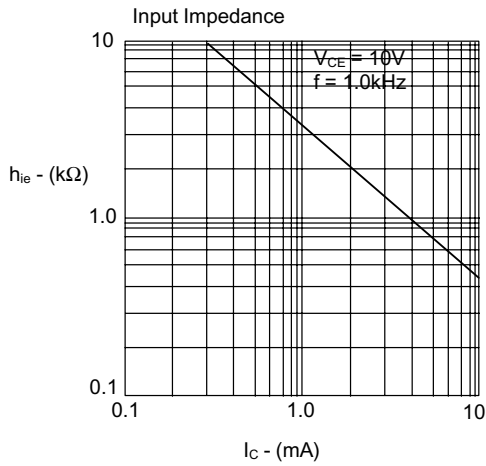



TM

Micro Commercial Components

Ordering Information :

Device	Packing
Part Number-AP	Ammo Packing: 20Kpcs/Carton
Part Number-BP	Bulk: 100Kpcs/Carton

Note : Adding "-HF" suffix for halogen free, eg. Part Number-AP-HF

IMPORTANT NOTICE

Micro Commercial Components Corp. reserves the right to make changes without further notice to any product herein to make corrections, modifications, enhancements, improvements, or other changes. **Micro Commercial Components Corp.** does not assume any liability arising out of the application or use of any product described herein; neither does it convey any license under its patent rights, nor the rights of others. The user of products in such applications shall assume all risks of such use and will agree to hold **Micro Commercial Components Corp.** and all the companies whose products are represented on our website, harmless against all damages.

LIFE SUPPORT

MCC's products are not authorized for use as critical components in life support devices or systems without the express written approval of Micro Commercial Components Corporation.

CUSTOMER AWARENESS

Counterfeiting of semiconductor parts is a growing problem in the industry. Micro Commercial Components (MCC) is taking strong measures to protect ourselves and our customers from the proliferation of counterfeit parts. MCC strongly encourages customers to purchase MCC parts either directly from MCC or from Authorized MCC Distributors who are listed by country on our web page cited below. Products customers buy either from MCC directly or from Authorized MCC Distributors are genuine parts, have full traceability, meet MCC's quality standards for handling and storage. **MCC will not provide any warranty coverage or other assistance for parts bought from Unauthorized Sources.** MCC is committed to combat this global problem and encourage our customers to do their part in stopping this practice by buying direct or from authorized distributors.

www.mccsemi.com



**Стандарт
Электрон
Связь**

Мы молодая и активно развивающаяся компания в области поставок электронных компонентов. Мы поставляем электронные компоненты отечественного и импортного производства напрямую от производителей и с крупнейших складов мира.

Благодаря сотрудничеству с мировыми поставщиками мы осуществляем комплексные и плановые поставки широчайшего спектра электронных компонентов.

Собственная эффективная логистика и склад в обеспечивает надежную поставку продукции в точно указанные сроки по всей России.

Мы осуществляем техническую поддержку нашим клиентам и предпродажную проверку качества продукции. На все поставляемые продукты мы предоставляем гарантию .

Осуществляем поставки продукции под контролем ВП МО РФ на предприятия военно-промышленного комплекса России , а также работаем в рамках 275 ФЗ с открытием отдельных счетов в уполномоченном банке. Система менеджмента качества компании соответствует требованиям ГОСТ ISO 9001.

Минимальные сроки поставки, гибкие цены, неограниченный ассортимент и индивидуальный подход к клиентам являются основой для выстраивания долгосрочного и эффективного сотрудничества с предприятиями радиоэлектронной промышленности, предприятиями ВПК и научно-исследовательскими институтами России.

С нами вы становитесь еще успешнее!

Наши контакты:

Телефон: +7 812 627 14 35

Электронная почта: sales@st-electron.ru

Адрес: 198099, Санкт-Петербург,
Промышленная ул, дом № 19, литера Н,
помещение 100-Н Офис 331