

Description

The AP3171 is a constant voltage (CV), constant current (CC) and synchronous rectification buck converter compatible with Qualcomm Quick Charge 2.0.

AP3171 combines PWM controller, high/low side power MOSFETs, CC/CV control and Qualcomm QC 2.0 decoder in one package so as to achieve high performance with compact profile. According to different D+/D- signal combinations, the AP3171 will set the output voltage and full current capabilities to 5V/2A, 9V/2A or 12V/1.5A respectively. The AP3171 automatically provides 5V/2A output configuration to backwards compatible to the existing devices that are not compatible to Qualcomm QC 2.0.

AP3171 has a fixed switching frequency of 120kHz at heavy load, while at light load and no load, its zero current detection (ZCD) function takes effect to have the system enter into discontinuous current mode (DCM) to improve power conversion efficiency.

The AP3171 has versatile protection functions to guarantee a safe operation, including input voltage under voltage lock-out (UVLO), output voltage over voltage protection (OVP) and under voltage protection (UVP), inductor peak current limit and Internal over temperature protection (OTP).

Furthermore, AP3171 has cable compensation and it is adjustable by the external resistor.

The AP3171 is available in SO-8EP package.

Features

- 8.7V to 40V Input Voltage Range
- Fixed 120k Operating Frequency
- Integrated Two MOSFETs for Synchronization Rectification
- Quick Charge Function Compatible with Qualcomm QC 2.0 Protocol
- Input Protection – UVLO
- Output Protection – UVP/OVP
- OCP Function
- Adjustable Cable Compensation
- Output CC/CV Mode Function
- Reference Accuracy :
CV $\pm 1.5\%$ CC $\pm 4\%$ (5V)
CV $\pm 2.5\%$ CC $\pm 5\%$ (9V/12V)
- Output power: 5V/10W, 9V/18W, 12V/18W
- Internal OTP Function
- **Totally Lead-free & Fully RoHS Compliant (Notes 1 & 2)**
- **Halogen and Antimony Free. "Green" Device (Note 3)**

Notes: 1. No purposely added lead. Fully EU Directive 2002/95/EC (RoHS) & 2011/65/EU (RoHS 2) compliant.
2. See http://www.diodes.com/quality/lead_free.html for more information about Diodes Incorporated's definitions of Halogen- and Antimony-free, "Green" and Lead-free.
3. Halogen- and Antimony-free "Green" products are defined as those which contain <900ppm bromine, <900ppm chlorine (<1500ppm total Br + Cl) and <1000ppm antimony compounds.

Pin Assignments

(Top View)

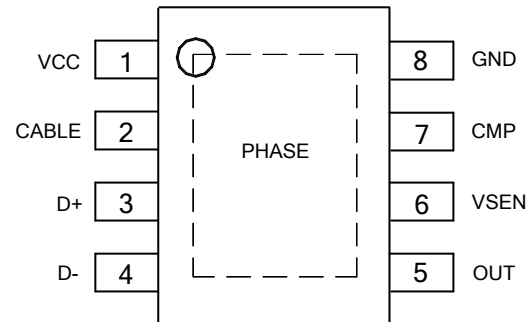

Note: The PHASE pin of BUCK converter is exposed PAD, which is at bottom of the IC (the dashed box).

SO-8EP

Applications

- Car Charger
- Automotive Power application
- General DC/DC Application Need CC/CV Mode

Typical Applications Circuit

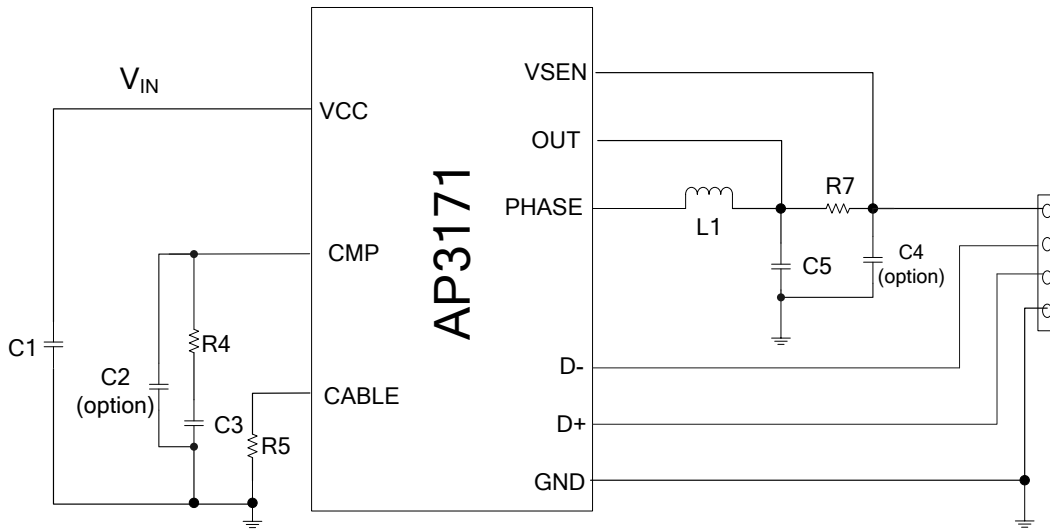

Pin Descriptions

Pin Number	Pin Name	Function
1	VCC	IC voltage supplier and input voltage for power conversion; Decoupling cap is required to be placed to this pin and GND pin as close as possible
2	CABLE	Connected to the external resistor to set the cable compensation value
3	D+	Connected to USB D+
4	D-	Connected to USB D-
5	OUT	Sense the output voltage; connected to the input of current sense resistor
6	VSEN	Sense the output current; connected to the output of current sense resistor
7	CMP	The EA output pin to compensate the loop
8	GND	Ground return for the power stage and controller
Exposed PAD	PHASE	Connected to the input of external output inductor

NEW PRODUCT

Functional Block Diagram

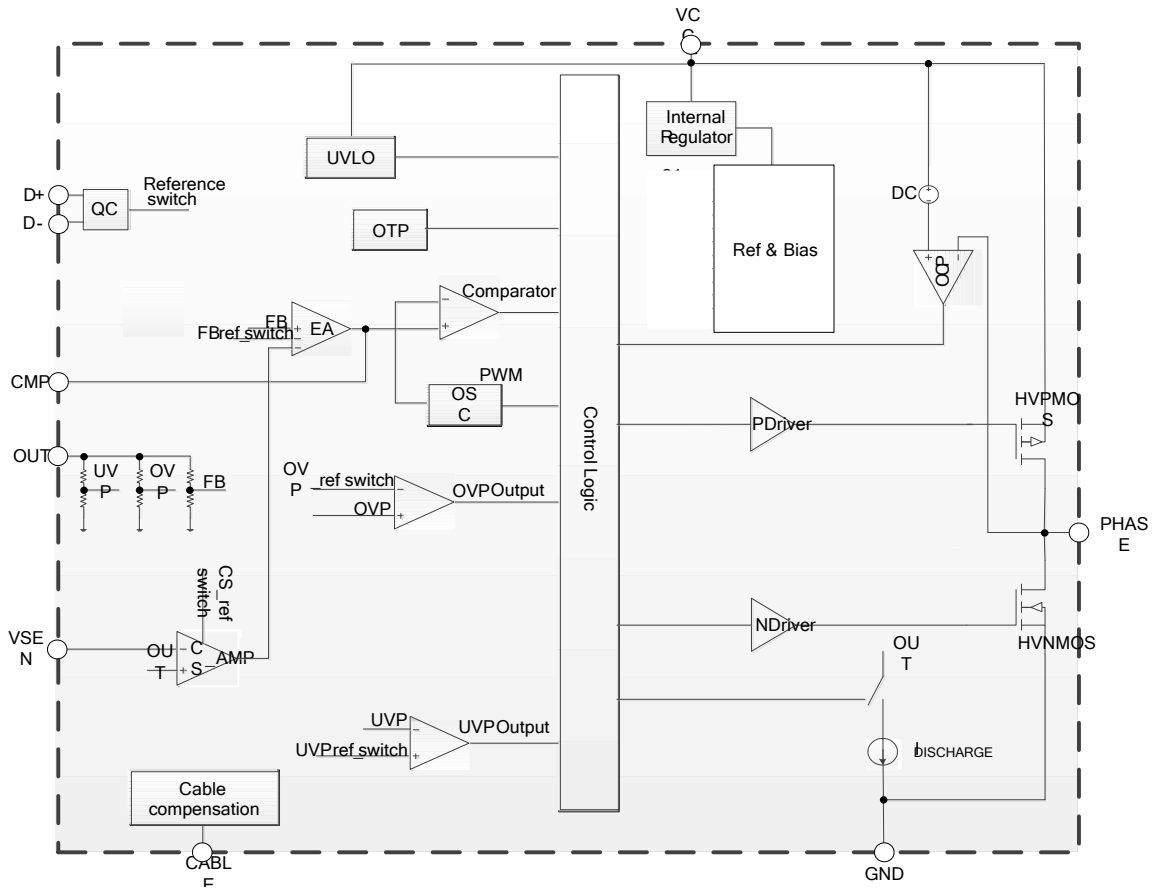

NEW PRODUCT

Absolute Maximum Ratings (Note 4)

Parameter	Symbol	Rating	Unit
Supply Voltage	V _{CC}	-0.3 to 42	V
Voltage From PHASE to GND	V _{PHASE}	-0.3 to 42	V
Voltage From OUT to GND	V _{OUT}	-0.3 to 20	V
Voltage on Other Separate Pins	–	-0.3 to 6	V
Thermal Resistance (Note 5)	θ _{JA}	63	°C/W
Operating Junction Temperature	T _J	-40 to +125	°C
Storage Temperature	T _{STG}	-65 to +150	°C
ESD (Human Body Model)	–	2000	V
ESD (Machine Model)	–	200	V

Note: 4. Stresses greater than those listed under "Absolute Maximum Ratings" may cause permanent damage to the device. These are stress ratings only, and functional operation of the device at these or any other conditions beyond those indicated under "Recommended Operating Conditions" is not implied. Exposure to "Absolute Maximum Ratings" for extended periods may affect device reliability.
5. Device mounted on FR-4 substrate PC board, 2oz copper, with 1 square inch pad layout.

Recommended Operating Conditions

Symbol	Parameter	Min	Max	Unit
V _{CC}	Supply Voltage	10	40	V
T _A	Ambient Temperature	-40	+85	°C

Electrical Characteristics (@T_A = +25°C, V_{CC} = 16V, unless otherwise specified.)

Symbol	Parameter	Conditions	Min	Typ	Max	Unit
Supply Voltage						
V _{ST}	Startup Voltage	–	8.4	8.7	9.0	V
–	UVLO	–	6.75	7.00	7.25	V
I _{NO-LOAD}	I _{CC} @ No-load Condition	–	–	2	–	mA
CV/CC Control						
V _{REF_12V}	Voltage Control Loop Reference	–	11.7	12.0	12.3	V
V _{REF_9V}		–	8.77	9.00	9.23	V
V _{REF_5V}		–	4.92	5.00	5.08	V
V _{CABLE}	Cable Compensation	R _{CABLE} = 17.6k, R _{SENSE} = 27.27mΩ	–	400	–	mV
V _{CS_12V}	Current Control Loop Reference	–	41.0	45.0	49.0	mV
V _{CS_9V}		–	57.0	60.0	63.0	mV
V _{CS_5V}		–	57.6	60.0	62.4	mV
Internal MOSFET						
R _{DS(ON)_UP}	High Side MOSFET R _{DS(ON)}	–	–	100	–	mΩ
R _{DS(ON)_LOW}	Low Side MOSFET R _{DS(ON)}	–	–	45	–	mΩ
PWM And Oscillation						
f _S	Switching Frequency	–	–	120	–	kHz
D _{MAX}	Maximum Duty	–	–	95	–	%
I _{DIS}	Discharge Current@ OUT Pin	–	–	100	–	mA
Protection						
V _{OVP_5V}	Output OVP Threshold @5V	Note 6	5.63	5.80	5.97	V
V _{OVP_9V}	Output OVP Threshold @9V		10.13	10.44	10.75	V
V _{OVP_12V}	Output OVP Threshold @12V		13.51	13.92	14.33	V
V _{UVP_5V}	Output UVP Threshold @5V	–	3.13	3.30	3.47	V
V _{UVP_9V}	Output UVP Threshold @9V	–	5.63	5.94	6.24	V
V _{UVP_12V}	Output UVP Threshold @12V	–	7.51	7.92	8.33	V
I _{PK_MAX}	MOSFET Maximum I _{PEAK} Limitation	–	–	4.0	–	A
Internal OTP						
–	Internal OTP Trigger Temperature	–	–	+160	–	°C
–	Internal OTP Recovery Temperature	–	–	+140	–	°C
QC 2.0 protocol definition						
V _{DAT_REF}	Data Detect Voltage	–	0.25	0.325	0.40	V
V _{SEL_REF}	V _{SEL_REF} (Reference for Selecting HVDCP Voltage)	–	1.8	2	2.2	V
t _{GLITCH_BC_DONE}	D+ High Glitch Filter Time	–	1	1.25	1.5	s
t _{GLITCH_DM_LOW}	D- Low Glitch Filter Time	Note 7	1	2.5	–	ms

Notes: 6. The value in table is only for I_O=0A. If I_O is not zero, the over voltage protection value needs to add cable compensation voltage.

7. Guaranteed by design.

Operation Description

Qualcomm QC 2.0 Protocol Operation

Decoder	V _{D+} (V)	V _{D-} (V)	Charger Output Voltage/Full Current Capability
Qualcomm Quick Charge 2.0 Protocol Class A: 5V, 9V, 12V	0.6	0.6	12V/1.5A
	3.3	0.6	9V/2A
	0.6	3.3	Keep Present V1/V2 Status Unchanged
	3.3	3.3	Keep Present V1/V2 Status Unchanged
	0.6 or 3.3	GND	5V/2A
	GND	0.6 or 3.3 or GND	5V/2A (Protocol Handshake Reset)

Constant Current Operation

The AP3171 can work in constant-current (CC) mode. The output current is sensed by a current sense resistor R_{SENSE}. As output current increases, the voltage drop across R_{SENSE} will be limited to a reference voltage (V_{CS}) to accomplish CC function. The default R_{SENSE} is 27.27mΩ to get the typical CC point of 110% full output current.

Cable Compensation

The cable compensation can be calculated as below:

$$V_{CABLE} = I_o * R_{SENSE} * 129.5k / R_{CABLE}$$

Ordering Information

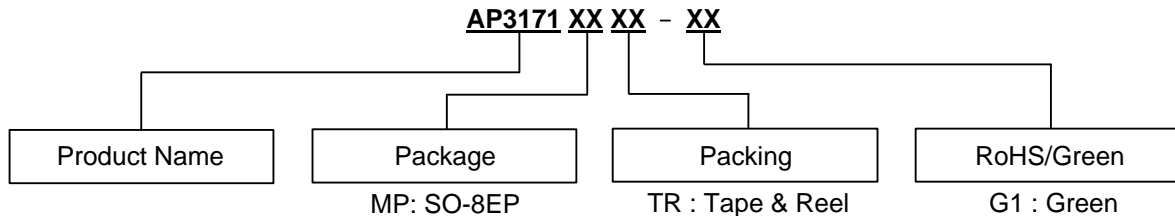

Package	Part Number	Marking ID	Packing
SO-8EP	AP3171MPTR-G1	3171MP-G1	4,000/Tape & Reel

Marking Information

(Top View)

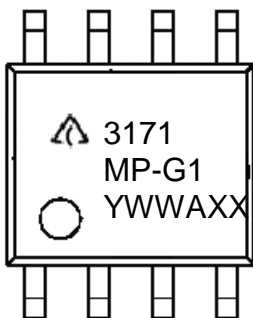

First and Second Lines: Logo and Marking ID
 Third Line: Date Code
 Y: Year
 WW: Work Week of Molding
 A: Assembly House Code
 XX: 7th and 8th Digits of Batch No.

Package Outline Dimensions (All dimensions in mm(inch).)

(1) Package Type: SO-8EP

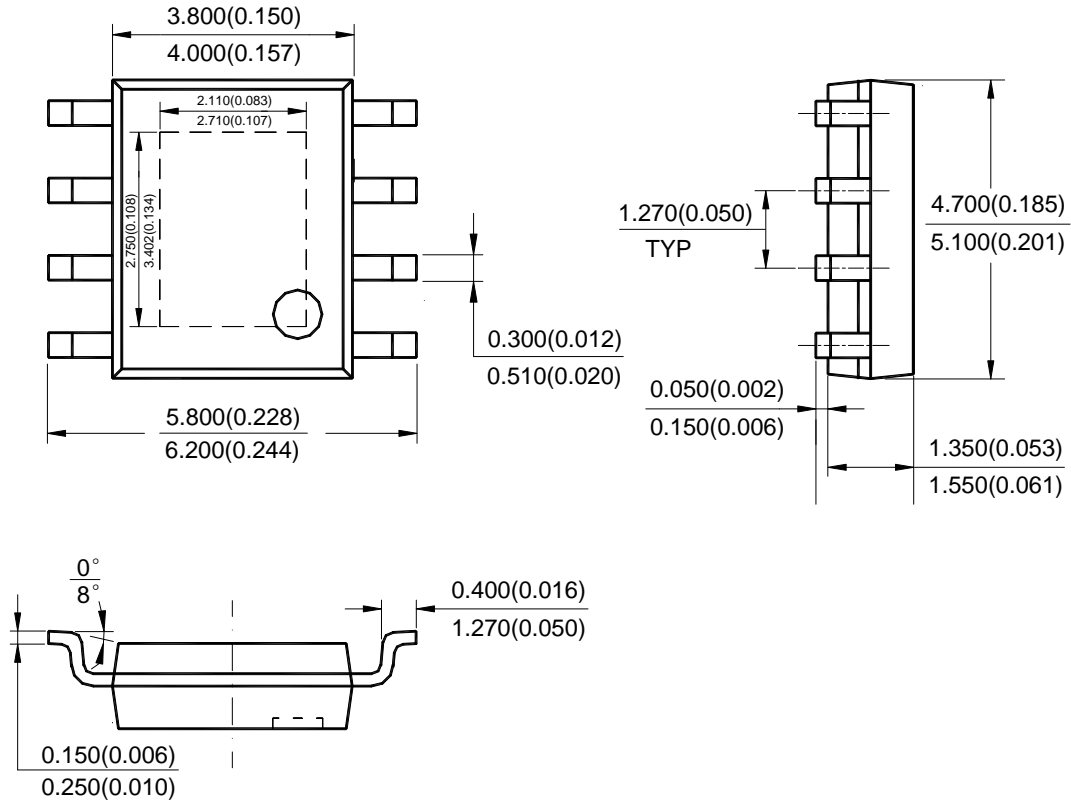

Note: Eject hole, oriented hole and mold mark is optional.

NEW PRODUCT

Suggested Pad Layout

(1) Package Type: SO-8EP

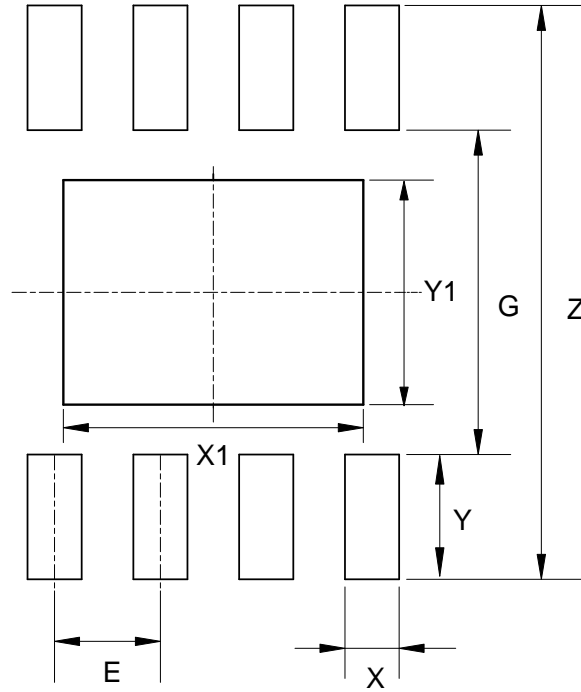

Dimensions	Z (mm)/(inch)	G (mm)/(inch)	X (mm)/(inch)	Y (mm)/(inch)	X1 (mm)/(inch)	Y1 (mm)/(inch)	E (mm)/(inch)
Value	6.900/0.272	3.900/0.154	0.650/0.026	1.500/0.059	3.600/0.142	2.700/0.106	1.270/0.050

NEW PRODUCT

IMPORTANT NOTICE

DIODES INCORPORATED MAKES NO WARRANTY OF ANY KIND, EXPRESS OR IMPLIED, WITH REGARDS TO THIS DOCUMENT, INCLUDING, BUT NOT LIMITED TO, THE IMPLIED WARRANTIES OF MERCHANTABILITY AND FITNESS FOR A PARTICULAR PURPOSE (AND THEIR EQUIVALENTS UNDER THE LAWS OF ANY JURISDICTION).

Diodes Incorporated and its subsidiaries reserve the right to make modifications, enhancements, improvements, corrections or other changes without further notice to this document and any product described herein. Diodes Incorporated does not assume any liability arising out of the application or use of this document or any product described herein; neither does Diodes Incorporated convey any license under its patent or trademark rights, nor the rights of others. Any Customer or user of this document or products described herein in such applications shall assume all risks of such use and will agree to hold Diodes Incorporated and all the companies whose products are represented on Diodes Incorporated website, harmless against all damages.

Diodes Incorporated does not warrant or accept any liability whatsoever in respect of any products purchased through unauthorized sales channel. Should Customers purchase or use Diodes Incorporated products for any unintended or unauthorized application, Customers shall indemnify and hold Diodes Incorporated and its representatives harmless against all claims, damages, expenses, and attorney fees arising out of, directly or indirectly, any claim of personal injury or death associated with such unintended or unauthorized application.

Products described herein may be covered by one or more United States, international or foreign patents pending. Product names and markings noted herein may also be covered by one or more United States, international or foreign trademarks.

This document is written in English but may be translated into multiple languages for reference. Only the English version of this document is the final and determinative format released by Diodes Incorporated.

LIFE SUPPORT

Diodes Incorporated products are specifically not authorized for use as critical components in life support devices or systems without the express written approval of the Chief Executive Officer of Diodes Incorporated. As used herein:

A. Life support devices or systems are devices or systems which:

1. are intended to implant into the body, or
2. support or sustain life and whose failure to perform when properly used in accordance with instructions for use provided in the labeling can be reasonably expected to result in significant injury to the user.

B. A critical component is any component in a life support device or system whose failure to perform can be reasonably expected to cause the failure of the life support device or to affect its safety or effectiveness.

Customers represent that they have all necessary expertise in the safety and regulatory ramifications of their life support devices or systems, and acknowledge and agree that they are solely responsible for all legal, regulatory and safety-related requirements concerning their products and any use of Diodes Incorporated products in such safety-critical, life support devices or systems, notwithstanding any devices- or systems-related information or support that may be provided by Diodes Incorporated. Further, Customers must fully indemnify Diodes Incorporated and its representatives against any damages arising out of the use of Diodes Incorporated products in such safety-critical, life support devices or systems.

Copyright © 2016, Diodes Incorporated

www.diodes.com



Стандарт Электрон Связь

Мы молодая и активно развивающаяся компания в области поставок электронных компонентов. Мы поставляем электронные компоненты отечественного и импортного производства напрямую от производителей и с крупнейших складов мира.

Благодаря сотрудничеству с мировыми поставщиками мы осуществляем комплексные и плановые поставки широчайшего спектра электронных компонентов.

Собственная эффективная логистика и склад в обеспечивает надежную поставку продукции в точно указанные сроки по всей России.

Мы осуществляем техническую поддержку нашим клиентам и предпродажную проверку качества продукции. На все поставляемые продукты мы предоставляем гарантию .

Осуществляем поставки продукции под контролем ВП МО РФ на предприятия военно-промышленного комплекса России , а также работаем в рамках 275 ФЗ с открытием отдельных счетов в уполномоченном банке. Система менеджмента качества компании соответствует требованиям ГОСТ ISO 9001.

Минимальные сроки поставки, гибкие цены, неограниченный ассортимент и индивидуальный подход к клиентам являются основой для выстраивания долгосрочного и эффективного сотрудничества с предприятиями радиоэлектронной промышленности, предприятиями ВПК и научно-исследовательскими институтами России.

С нами вы становитесь еще успешнее!

Наши контакты:

Телефон: +7 812 627 14 35

Электронная почта: sales@st-electron.ru

Адрес: 198099, Санкт-Петербург,
Промышленная ул, дом № 19, литера Н,
помещение 100-Н Офис 331