



# LUXEON 3014 with FreshFocus Technology™

Accentuating freshness and overall visual appeal, making food irresistible



The LUXEON 3014 with FreshFocus Technology creates the most impactful lighting ever available by accentuating the freshness and overall visual appeal of a variety of fresh food areas such as supermarkets, delis, butcher shops and bakeries. LUXEON 3014 with FreshFocus Technology is an industry standard compatible 3.0mm x 1.4mm x 0.75mm footprint with specialty color and spectrum targeted for highlighting the colors of different foods.

## FEATURES AND BENEFITS

Industry standard footprint and package compatible with existing designs

1/9<sup>th</sup> ANSI micro-color binning enabling tight color control

Rectangular package design allows for increased uniformity

Drive at maximum current (120mA) for superior value

## PRIMARY APPLICATIONS

Specialty Lighting

- Fresh Foods
- Linear Display

# Table of Contents

<b>General Product Information</b> .....	<b>2</b>
Product Test Conditions .....	2
Part Number Nomenclature .....	2
Lumen Maintenance .....	2
Environmental Compliance .....	2
<b>Performance Characteristics</b> .....	<b>3</b>
Product Selection Guide .....	3
Optical Characteristics .....	3
Electrical and Thermal Characteristics .....	3
<b>Absolute Maximum Ratings</b> .....	<b>4</b>
<b>Characteristic Curves</b> .....	<b>5</b>
Spectral Power Distribution Characteristics .....	5
Light Output Characteristics .....	5
Forward Current Characteristics .....	6
Radiation Pattern Characteristics .....	7
<b>Product Bin and Labeling Definitions</b> .....	<b>8</b>
Decoding Product Bin Labeling .....	8
Luminous Flux Bins .....	8
Color Bin Definitions .....	9
Forward Voltage Bins .....	10
<b>Mechanical Dimensions</b> .....	<b>10</b>
<b>Reflow Soldering Guidelines</b> .....	<b>11</b>
JEDEC Moisture Sensitivity .....	11
Solder Pad Design .....	12
<b>Packaging Information</b> .....	<b>12</b>
Pocket Tape Dimensions .....	13
Reel Dimensions .....	13

# General Product Information

## Product Test Conditions

LUXEON 3014 with FreshFocus Technology™ LEDs are tested and binned with 20ms monopulse of 60mA, at a junction temperature,  $T_j$ , of 25°C.

## Part Number Nomenclature

Part numbers for LUXEON 3014 with FreshFocus Technology follow the convention below:

L 1 3 0 – **A A B B** 0 0 1 4 0 0 0 0 1

Where:

**A A** – designates product spectrum type (MM=Marbled Meat)

**B B** designates color spectrum and color rendering options (SA=Spectrum A)

Therefore, the following part number is used for a LUXEON 3014 with FreshFocus Technology for Marbled Meat:

L 1 3 0 – **M M S A** 0 0 1 4 0 0 0 0 1

## Lumen Maintenance

Please contact your local Sales Representative or Lumileds Technical Solutions Manager for more information about the long-term performance of this product.

## Environmental Compliance

Lumileds LLC is committed to providing environmentally friendly products to the solid-state lighting market. LUXEON 3014 with FreshFocus Technology is compliant to the European Union directives on the restriction of hazardous substances in electronic equipment, namely the RoHS Directive 2011/65/EU and REACH Regulation (EC) 1907/2006. Lumileds LLC will not intentionally add the following restricted materials to its products: lead, mercury, cadmium, hexavalent chromium, polybrominated biphenyls (PBB) or polybrominated diphenyl ethers (PBDE).

# Performance Characteristics

## Product Selection Guide

Table 1. Product performance of LUXEON 3014 with FreshFocus Technology at 60mA, T<sub>j</sub>=25°C.

PRODUCT SPECTRUM	MINIMUM CRI <sup>[1]</sup>	LUMINOUS FLUX <sup>[1]</sup> (lm)		TYPICAL LUMINOUS EFFICACY (lm/W)	PART NUMBER
		MINIMUM	TYPICAL		
Marbled Meat	80	14.5	17.0	86.0	L130-MMSA001400001

**Notes for Table 1:**

1. Lumileds maintains a tolerance of ±2 on CRI and ±7.5% on luminous flux measurements.

## Optical Characteristics

Table 2. Optical characteristics for LUXEON 3014 with FreshFocus Technology at 60mA, T<sub>j</sub>=25°C.

PART NUMBER	TYPICAL TOTAL INCLUDED ANGLE <sup>[1]</sup>	TYPICAL VIEWING ANGLE <sup>[2]</sup>
L130-MMSA001400001	160°	120°

**Notes for Table 2:**

1. Total angle at which 90% of total luminous flux is captured.

2. Viewing angle is the off axis angle from the LED centerline where the luminous intensity is ½ of the peak value.

## Electrical and Thermal Characteristics

Table 3. Electrical and thermal characteristics for LUXEON 3014 with FreshFocus Technology at 60mA, T<sub>j</sub>=25°C.

PART NUMBER	FORWARD VOLTAGE <sup>[1]</sup> (V <sub>f</sub> )			TYPICAL TEMPERATURE COEFFICIENT OF FORWARD VOLTAGE (mV/°C)	TYPICAL THERMAL RESISTANCE — JUNCTION TO SOLDER PAD (°C/W)
	MINIMUM	TYPICAL	MAXIMUM		
L130-MMSA001400001	2.8	3.1	3.3	-2.0 to -4.0	35

**Notes for Table 3:**

1. Lumileds maintains a tolerance of ±0.1V on forward voltage measurements.

# Absolute Maximum Ratings

Table 4. Absolute maximum ratings for LUXEON 3014 with FreshFocus Technology.

PARAMETER	MAXIMUM PERFORMANCE
DC Forward Current <sup>[1, 2]</sup>	120mA
Peak Pulsed Forward Current <sup>[1, 3]</sup>	150mA
LED Junction Temperature <sup>[1]</sup> (DC & Pulse)	115°C
ESD Sensitivity	Class 2A JS-001-2012
Operating Case Temperature <sup>[1]</sup>	-40°C to 105°C
LED Storage Temperature	-40°C to 100°C
Soldering Temperature	JEDEC 020D 260°C
Allowable Reflow Cycles	3
Reverse Voltage ( $V_{reverse}$ )	-5V

**Notes for Table 4:**

1. Proper current derating must be observed to maintain the junction temperature below the maximum allowable junction temperature.
2. Residual periodic variations due to power conversion from alternating current (AC) to direct current (DC), also called "ripple," are acceptable if the following conditions are met:
  - The frequency of the ripple current is 100Hz or higher
  - The average current for each cycle does not exceed the maximum allowable DC forward current
  - The maximum amplitude of the ripple does not exceed 15% of the maximum allowable DC forward current
3. Pulsed operation with the maximum peak pulsed forward current is acceptable if the pulse on-time is ≤5ms per cycle and the duty cycle is ≤50%.

# Characteristic Curves

## Spectral Power Distribution Characteristics

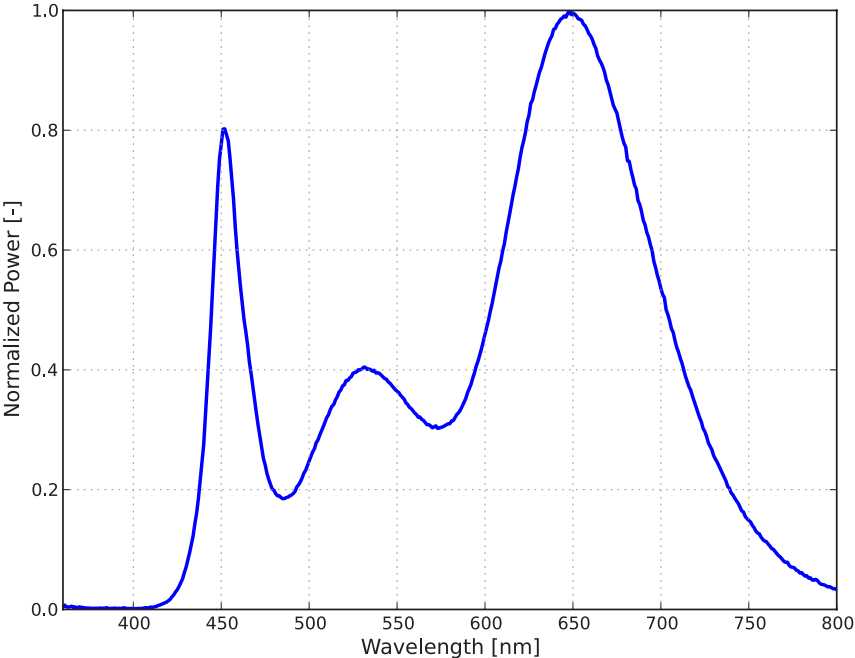

Figure 1. Typical normalized power vs. wavelength for LUXEON 3014 with FreshFocus Technology at 60mA,  $T_j=25^{\circ}\text{C}$ .

## Light Output Characteristics

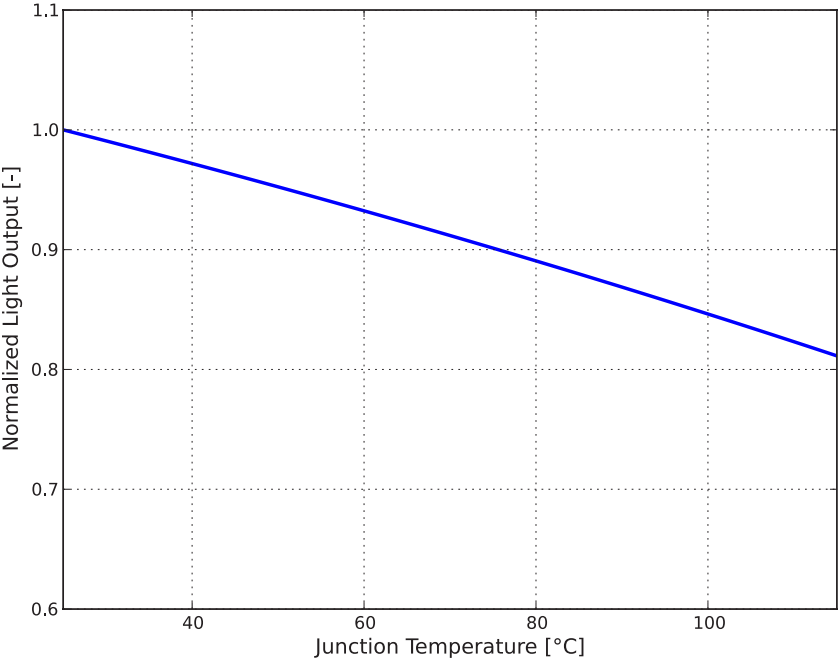

Figure 2. Typical normalized light output vs. junction temperature for LUXEON 3014 with FreshFocus Technology at 60mA.

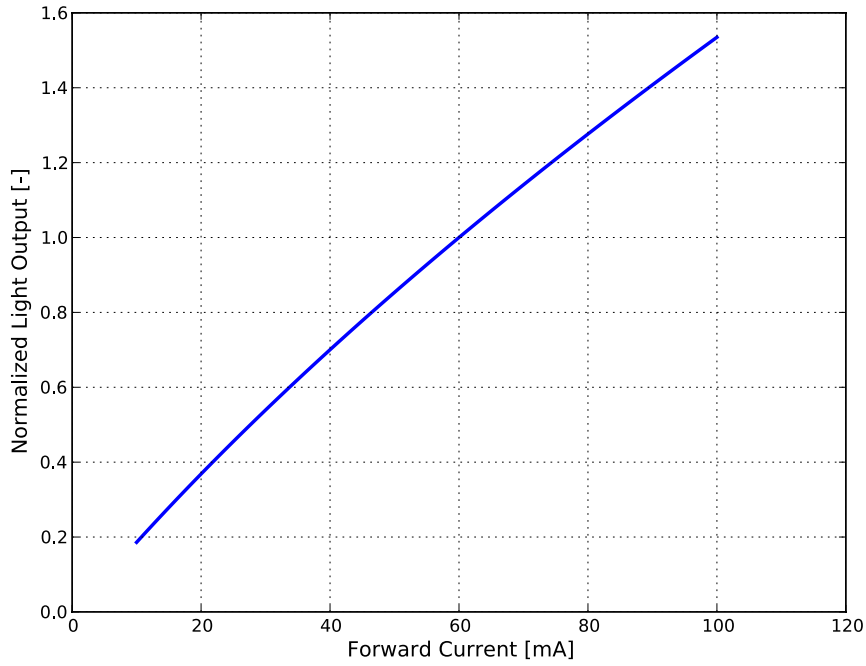

Figure 3. Typical normalized light output vs. forward current for LUXEON 3014 with FreshFocus Technology at  $T_j=25^\circ\text{C}$ .

## Forward Current Characteristics

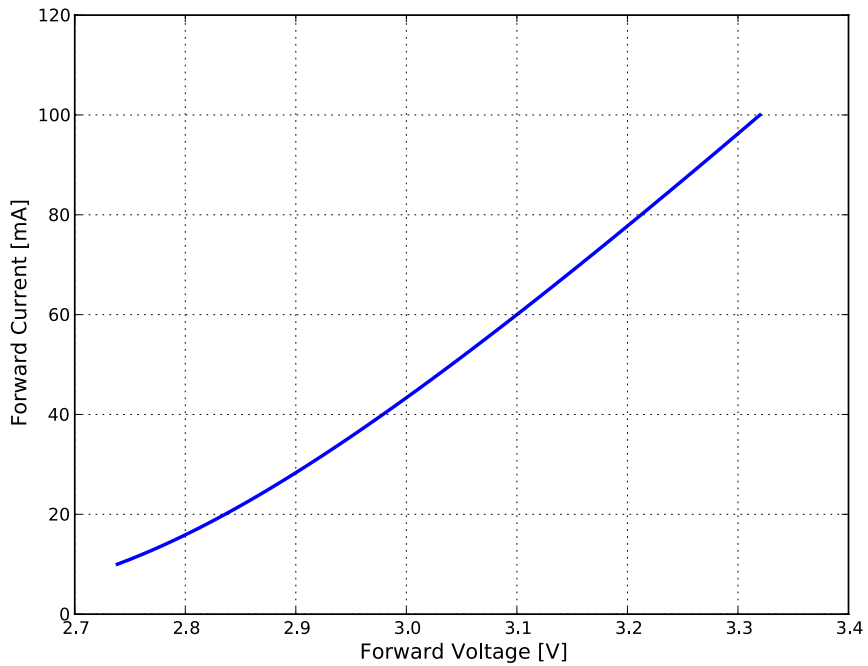

Figure 4. Typical forward current vs. forward voltage for LUXEON 3014 with FreshFocus Technology at  $T_j=25^\circ\text{C}$ .

# Radiation Pattern Characteristics

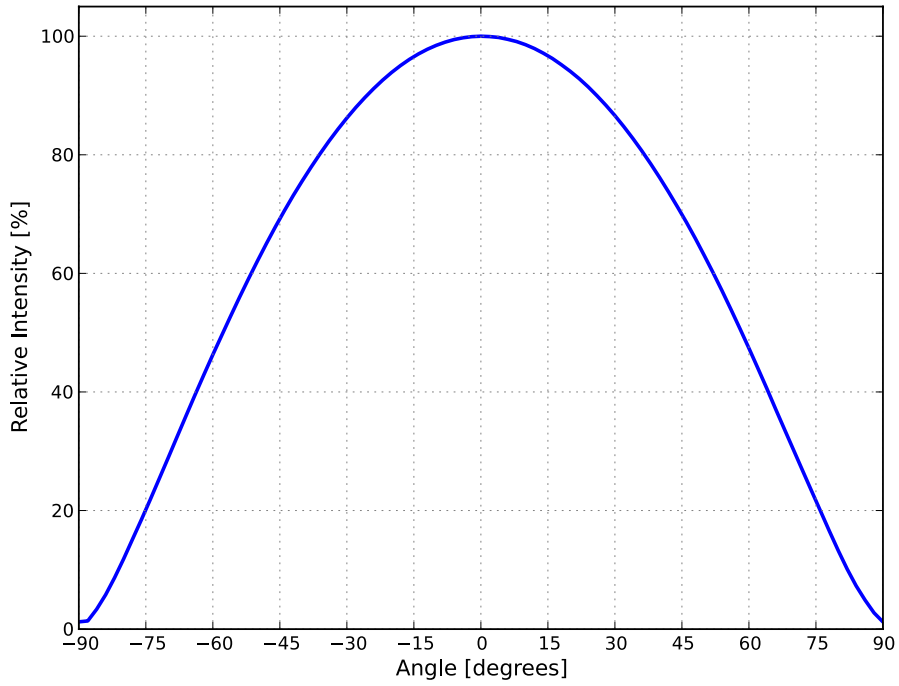

Figure 5. Typical radiation pattern for LUXEON 3014 with FreshFocus Technology at 60mA,  $T_j=25^{\circ}\text{C}$ .

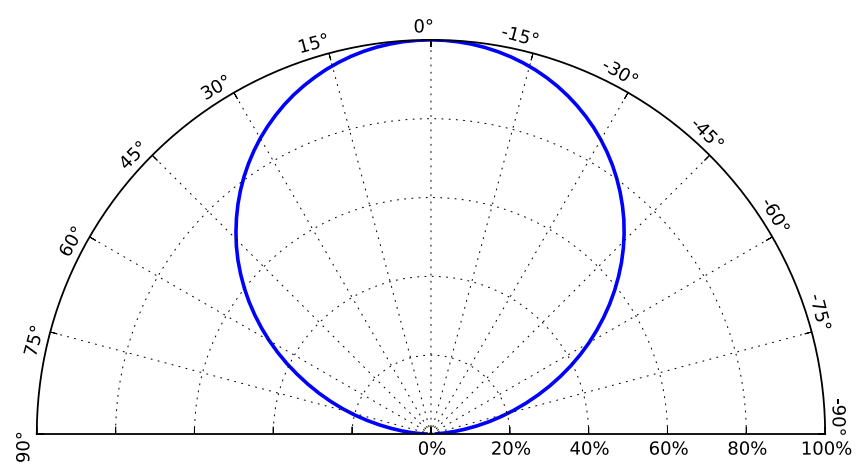

Figure 6. Typical polar radiation pattern for LUXEON 3014 with FreshFocus Technology at 60mA,  $T_j=25^{\circ}\text{C}$ .



# Product Bin and Labeling Definitions

## Decoding Product Bin Labeling

In the manufacturing of semiconductor products, there are variations in performance around the average values given in the technical datasheet. For this reason, Lumileds bins LED components for luminous flux or radiometric power, color point, peak or dominant wavelength and forward voltage.

LUXEON 3014 with FreshFocus Technology LEDs are labeled using a 5-digit alphanumeric CAT code following the format below:

**A x B C D**

Where:

- A x** – designates luminous flux bin (example: E0=15 to 17 lumens, G0=19 to 21 lumens)
- B C** – designates color bin (example: DD, DE, DF, DG, DH, DJ, DK, DL, DM)
- D** – designates forward voltage bin (example: T=2.8 to 2.9V, X=3.1 to 3.2V)

Therefore, a LUXEON 3014 with FreshFocus Technology with a lumen range of 15 to 17, color bin of DF and a forward voltage range of 2.8 to 2.9V has the following CAT code:

**E 0 D F T**

## Luminous Flux Bins

Table 5 lists the standard luminous flux bins for LUXEON 3014 with FreshFocus Technology emitters. Although several bins are outlined, product availability in a particular bin varies by production run and by product performance. Not all bins are available in all CCTs.

Table 5. Luminous flux bin definitions for LUXEON 3014 with FreshFocus Technology at 60mA, T<sub>j</sub>=25°C.

BIN	LUMINOUS FLUX <sup>[1]</sup> (lm)	
	MINIMUM	MAXIMUM
D0	13	15
E0	15	17
F0	17	19
G0	19	21

Notes for Table 5:

1. Lumileds maintains a tolerance of ±7.5% on luminous flux measurements.

# Color Bin Definitions

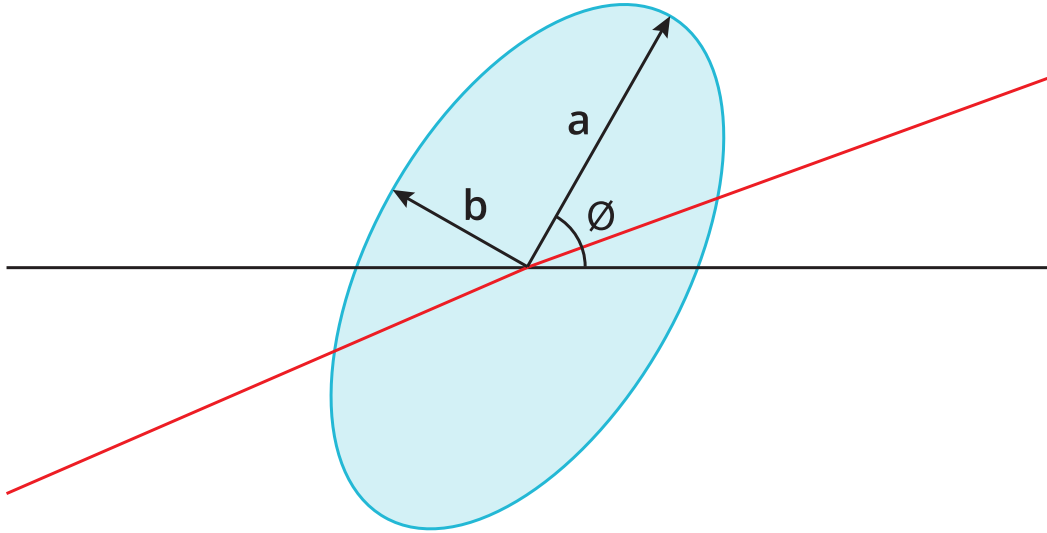

Figure 7. 3- and 5-step MacAdam ellipse illustration for Table 6.

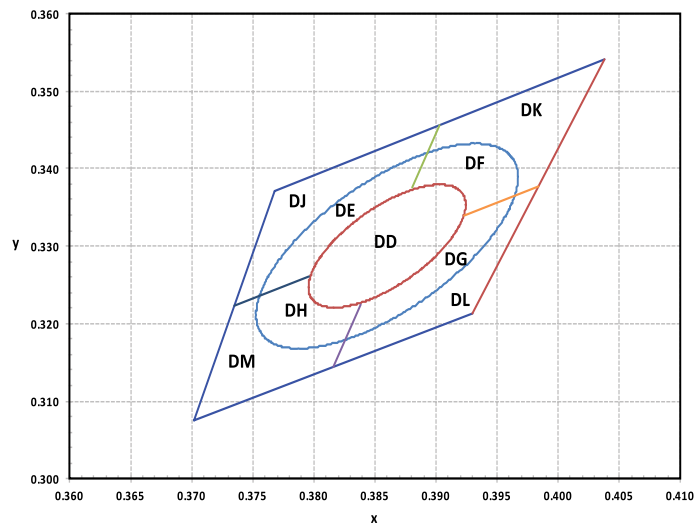

Figure 8. Color bin structure for LUXEON 3014 with FreshFocus Technology Marbled Meat.

Table 6. 3- and 5-step MacAdam ellipse color bin definitions for LUXEON 3014 with FreshFocus Technology at 60mA, T<sub>j</sub>=25°C.

PRODUCT	COLOR SPACE	CENTER POINT <sup>(1)</sup> (cx, cy)	MAJOR AXIS, a	MINOR AXIS, b	ELLIPSE ROTATION ANGLE, θ
L130-MMSA001400001	Single 3-step MacAdam ellipse	(0.3860, 0.3300)	0.00939	0.00402	53.72°
L130-MMSA001400001	Single 5-step MacAdam ellipse	(0.3860, 0.3300)	0.01565	0.00670	53.72°

Notes for Table 6:

1. Lumileds maintains a tolerance of ±0.005 on x and y coordinates in the CIE 1931 color space.

# Forward Voltage Bins

Table 7. Forward voltage bin definitions for LUXEON 3014 with FreshFocus Technology,  $T_j=25^{\circ}\text{C}$ .

BIN	FORWARD VOLTAGE <sup>(1)</sup> (V <sub>f</sub> )	
	MINIMUM	MAXIMUM
T	2.8	2.9
V	2.9	3.0
W	3.0	3.1
X	3.1	3.2
Y	3.2	3.3
Z	3.3	3.4

**Notes for Table 7:**

1. Lumileds maintains a tolerance of  $\pm 0.1\text{V}$  on forward voltage measurements.

# Mechanical Dimensions

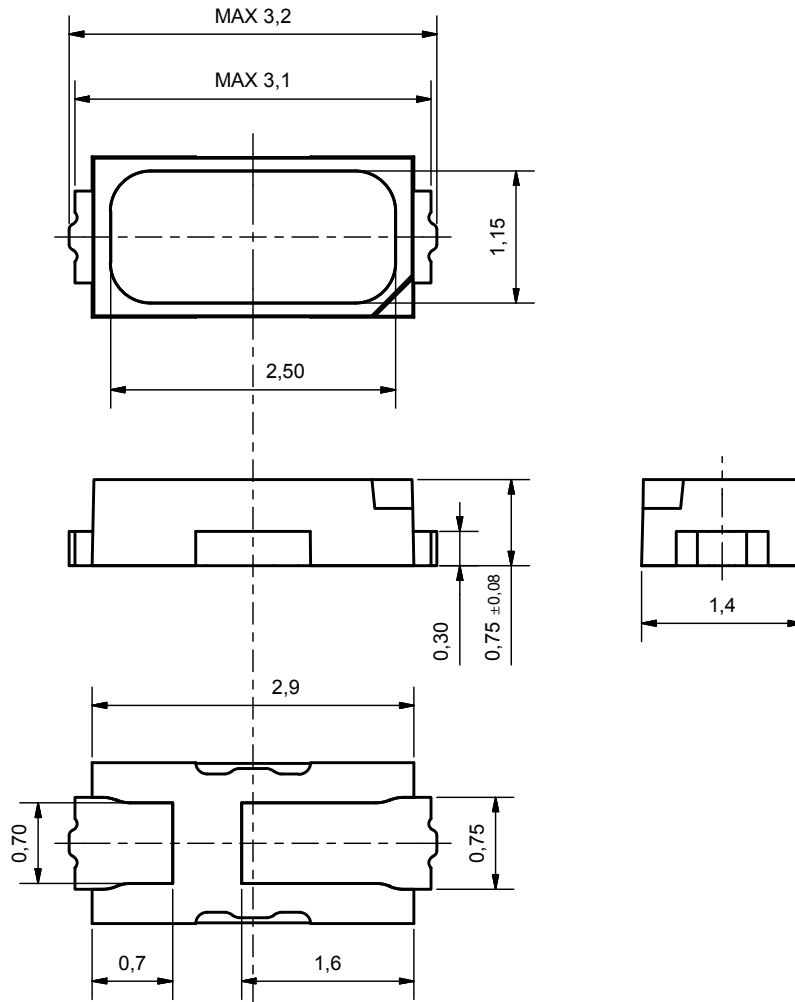

Figure 9. Mechanical dimensions for LUXEON 3014 with FreshFocus Technology.

**Notes for Figure 9:**

1. Drawings are not to scale.
2. All dimensions are in millimeters.

# Reflow Soldering Guidelines

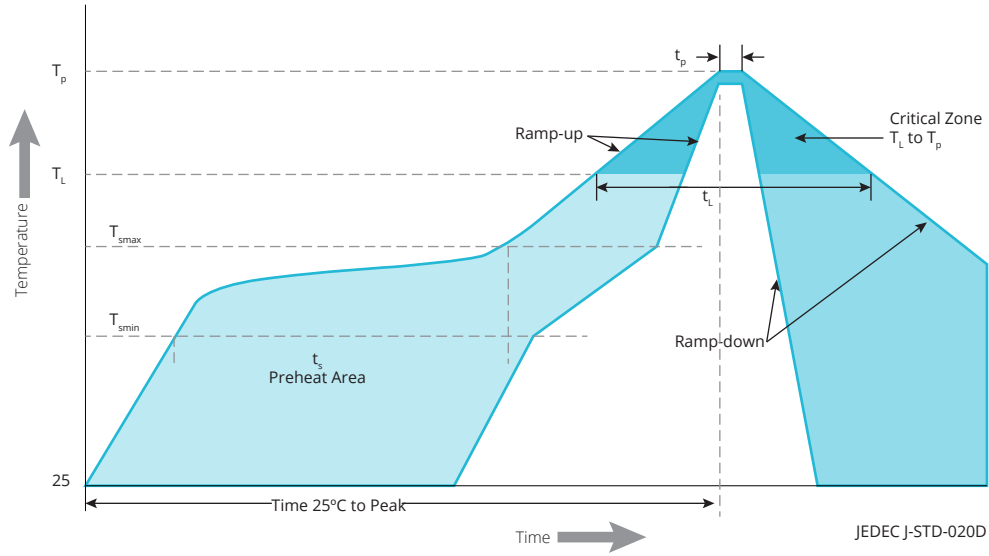

Figure 10. Visualization of the acceptable reflow temperature profile as specified in Table 8.

Table 8. Reflow profile characteristics for LUXEON 3014 with FreshFocus Technology.

PROFILE FEATURE	LEAD-FREE ASSEMBLY
Preheat Minimum Temperature ( $T_{smin}$ )	150°C
Preheat Maximum Temperature ( $T_{smax}$ )	200°C
Preheat Time ( $t_{smin}$ to $t_{smax}$ )	60 to 120 seconds
Ramp-Up Rate ( $T_L$ to $T_p$ )	3°C / second maximum
Liquidus Temperature ( $T_L$ )	217°C
Time Maintained Above Temperature $T_L$ ( $t_t$ )	60 to 150 seconds
Peak / Classification Temperature ( $T_p$ )	260°C
Time Within 5°C of Actual Temperature ( $t_p$ )	10 to 30 seconds
Ramp-Down Rate ( $T_p$ to $T_L$ )	6°C / second maximum
Time 25°C to Peak Temperature	8 minutes maximum

## JEDEC Moisture Sensitivity

Table 9. Moisture sensitivity levels for LUXEON 3014 with FreshFocus Technology.

LEVEL	FLOOR LIFE		SOAK REQUIREMENTS STANDARD	
	TIME	CONDITIONS	TIME	CONDITIONS
3	168 Hours	≤30°C / 60% RH	192 Hours +5 / -0	30°C / 60% RH

# Solder Pad Design

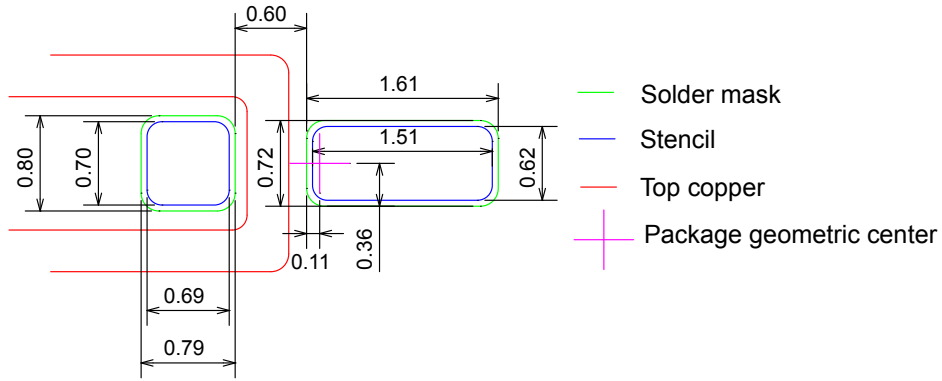

Figure 11. Recommended PCB solder pad layout for LUXEON 3014 with FreshFocus Technology.

- Notes for Figure 10:
1. Drawings are not to scale.
  2. All dimensions are in millimeters.

# Packaging Information

Table 10. Material and component specifications for LUXEON 3014 with FreshFocus Technology.

MATERIAL/COMPONENT	SPECIFICATION
Lead Frame Base	Copper Alloy
Package Body	High Temperature Thermal Plastic
Encapsulate	Silicone Resin, with Phosphor
Weight	0.009 gram

## Pocket Tape Dimensions

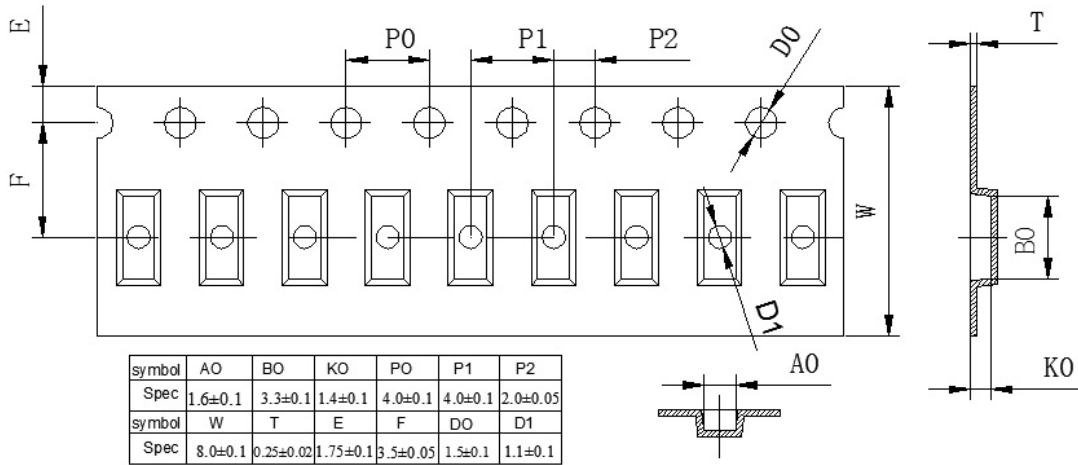

Figure 12. Pocket tape dimensions for LUXEON 3014 with FreshFocus Technology.

### Notes for Figure 12:

1. Drawings are not to scale.
2. All dimensions are in millimeters.
3. The maximum number of consecutive LEDs missing is two.

## Reel Dimensions

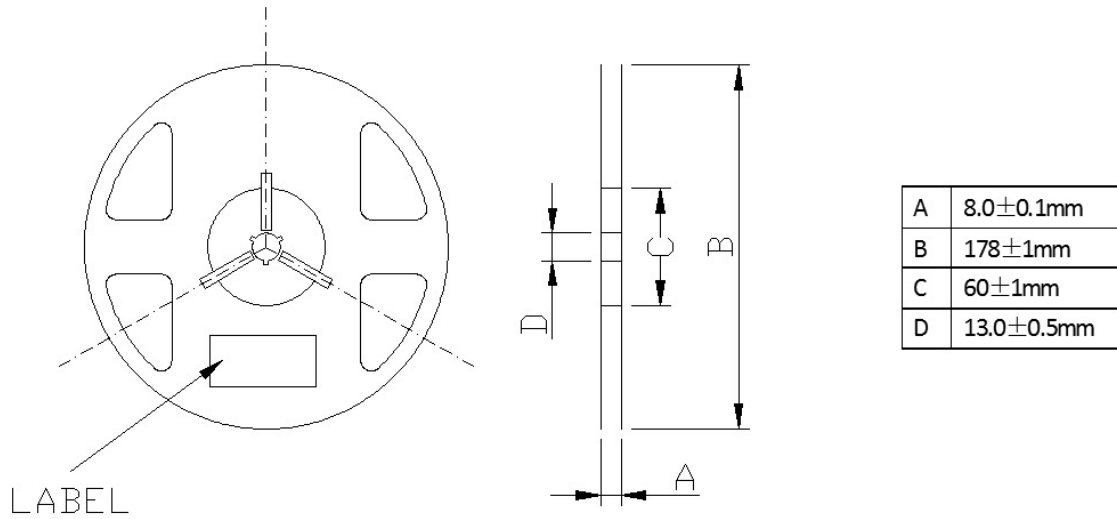

Figure 13. Reel dimensions for LUXEON 3014 with FreshFocus Technology.

### Notes for Figure 13:

1. Drawings are not to scale.
2. All dimensions are in millimeters.

## About Lumileds

Companies developing automotive, mobile, IoT and illumination lighting applications need a partner who can collaborate with them to push the boundaries of light. With over 100 years of inventions and industry firsts, Lumileds is a global lighting solutions company that helps customers around the world deliver differentiated solutions to gain and maintain a competitive edge. As the inventor of Xenon technology, a pioneer in halogen lighting and the leader in high performance LEDs, Lumileds builds innovation, quality and reliability into its technology, products and every customer engagement. Together with its customers, Lumileds is making the world safer, better and more beautiful—with light.

To learn more about our lighting solutions, visit [lumileds.com](http://lumileds.com).



---

©2018 Lumileds Holding B.V. All rights reserved.  
LUXEON is a registered trademark of the Lumileds Holding B.V. in the United States and other countries.  
[lumileds.com](http://lumileds.com)

Neither Lumileds Holding B.V. nor its affiliates shall be liable for any kind of loss of data or any other damages, direct, indirect or consequential, resulting from the use of the provided information and data. Although Lumileds Holding B.V. and/or its affiliates have attempted to provide the most accurate information and data, the materials and services information and data are provided "as is," and neither Lumileds Holding B.V. nor its affiliates warrants or guarantees the contents and correctness of the provided information and data. Lumileds Holding B.V. and its affiliates reserve the right to make changes without notice. You as user agree to this disclaimer and user agreement with the download or use of the provided materials, information and data. A listing of Lumileds product/patent coverage may be accessed at [lumileds.com/patents](http://lumileds.com/patents).



## Стандарт Электрон Связь

Мы молодая и активно развивающаяся компания в области поставок электронных компонентов. Мы поставляем электронные компоненты отечественного и импортного производства напрямую от производителей и с крупнейших складов мира.

Благодаря сотрудничеству с мировыми поставщиками мы осуществляем комплексные и плановые поставки широчайшего спектра электронных компонентов.

Собственная эффективная логистика и склад в обеспечивает надежную поставку продукции в точно указанные сроки по всей России.

Мы осуществляем техническую поддержку нашим клиентам и предпродажную проверку качества продукции. На все поставляемые продукты мы предоставляем гарантию .

Осуществляем поставки продукции под контролем ВП МО РФ на предприятия военно-промышленного комплекса России , а также работаем в рамках 275 ФЗ с открытием отдельных счетов в уполномоченном банке. Система менеджмента качества компании соответствует требованиям ГОСТ ISO 9001.

Минимальные сроки поставки, гибкие цены, неограниченный ассортимент и индивидуальный подход к клиентам являются основой для выстраивания долгосрочного и эффективного сотрудничества с предприятиями радиоэлектронной промышленности, предприятиями ВПК и научно-исследовательскими институтами России.

С нами вы становитесь еще успешнее!

### Наши контакты:

**Телефон:** +7 812 627 14 35

**Электронная почта:** [sales@st-electron.ru](mailto:sales@st-electron.ru)

**Адрес:** 198099, Санкт-Петербург,  
Промышленная ул, дом № 19, литера Н,  
помещение 100-Н Офис 331