

## ADG821/ADG822/ADG823

### FEATURES

- 0.8  $\Omega$  maximum on resistance @ 125°C
- 0.3  $\Omega$  maximum on resistance flatness @ 125°C
- 1.8 V to 5.5 V single supply
- 200 mA current carrying capability
- Automotive temperature range: -40°C to +125°C
- Rail-to-rail operation
- 8-lead MSOP
- 33 ns switching times
- Typical power consumption: <0.01  $\mu$ W
- TTL-/CMOS-compatible inputs
- Pin-compatible with the ADG721/ADG722/ADG723

### APPLICATIONS

- Power routing
- Battery-powered systems
- Communication systems
- Data acquisition systems
- Audio and video signal routing
- Cellular phones
- Modems
- PCMCIA cards
- Hard drives
- Relay replacement

### GENERAL DESCRIPTION

The ADG821/ADG822/ADG823 are monolithic CMOS single-pole, single-throw (SPST) switches. These switches are designed on an advanced submicron process that provides low power dissipation, yet gives high switching speed, low on resistance, and low leakage currents.

The ADG821/ADG822/ADG823 are designed to operate from a single 1.8 V to 5.5 V supply, making them ideal for use in battery-powered instruments.

Each switch of the ADG821/ADG822/ADG823 conducts equally well in both directions when on. The ADG821/ADG822/ADG823 contain two independent SPST switches. The ADG821 and ADG822 differ only in that both switches are normally open and normally closed, respectively. In the ADG823, Switch 1 is normally open and Switch 2 is normally closed. The ADG823 exhibits break-before-make switching action.

The ADG821/ADG822/ADG823 are available in an 8-lead MSOP.

#### Rev. A

Information furnished by Analog Devices is believed to be accurate and reliable. However, no responsibility is assumed by Analog Devices for its use, nor for any infringements of patents or other rights of third parties that may result from its use. Specifications subject to change without notice. No license is granted by implication or otherwise under any patent or patent rights of Analog Devices. Trademarks and registered trademarks are the property of their respective owners.

### FUNCTIONAL BLOCK DIAGRAMS

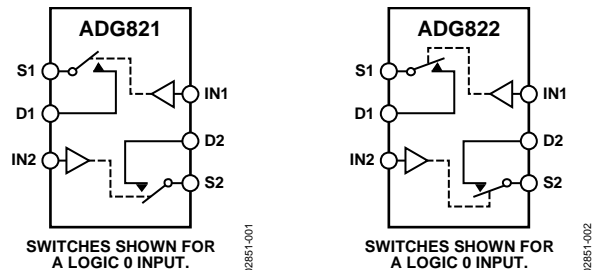

Figure 1.

Figure 2.

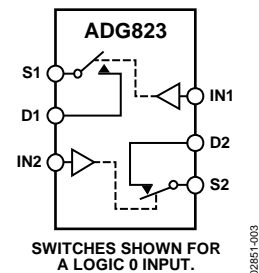

Figure 3.

### PRODUCT HIGHLIGHTS

1. Very Low On Resistance: 0.5  $\Omega$  typ.
2. On Resistance Flatness ( $R_{FLAT(ON)}$ ): 0.15  $\Omega$  typ.
3. Automotive Temperature Range: -40°C to +125°C.
4. Current Carrying Capability: 200 mA.
5. Low Power Dissipation. CMOS construction ensures low power dissipation.
6. 8-Lead MSOP.

**TABLE OF CONTENTS**

Features .....	1	ESD Caution.....	5
Applications.....	1	Pin Configuration and Function Descriptions.....	6
Functional Block Diagrams.....	1	Typical Performance Characteristics .....	7
General Description .....	1	Test Circuits.....	9
Product Highlights .....	1	Terminology .....	11
Revision History .....	2	Outline Dimensions .....	12
Specifications.....	3	Ordering Guide .....	12
Absolute Maximum Ratings.....	5		

**REVISION HISTORY**

**4/08—Rev. 0 to Rev. A**

Updated Format.....	Universal
Added Table 6.....	6
Updated Outline Dimensions .....	12
Changes to Ordering Guide .....	12

**8/02—Revision 0: Initial Version**

## SPECIFICATIONS

$V_{DD} = 5\text{ V} \pm 10\%$ ,  $GND = 0\text{ V}$ ;  $T_A = -40^\circ\text{C}$  to  $+125^\circ\text{C}$ , unless otherwise noted.

Table 1.

Parameter	25°C	-40°C to +85°C	-40°C to +125°C <sup>1</sup>	Unit	Test Conditions/Comments
<b>ANALOG SWITCH</b>					
Analog Signal Range			0 V to $V_{DD}$	V	
On Resistance ( $R_{ON}$ )	0.5			$\Omega$ typ	$V_S = 0\text{ V}$ to $V_{DD}$ , $I_S = 100\text{ mA}$ , see Figure 17
	0.6	0.7	0.8	$\Omega$ max	
On Resistance Match Between Channels ( $\Delta R_{ON}$ )	0.16			$\Omega$ typ	$V_S = 0\text{ V}$ to $V_{DD}$ , $I_S = 100\text{ mA}$
	0.2	0.25	0.28	$\Omega$ max	
On Resistance Flatness ( $R_{FLAT(ON)}$ )	0.15			$\Omega$ typ	$V_S = 0\text{ V}$ to $V_{DD}$ , $I_S = 100\text{ mA}$
	0.23	0.26	0.3	$\Omega$ max	
<b>LEAKAGE CURRENTS</b>					
Source Off Leakage, $I_S$ (Off)	$\pm 0.01$			nA typ	$V_{DD} = 5.5\text{ V}$ $V_S = 4.5\text{ V}/1\text{ V}$ , $V_D = 1\text{ V}/4.5\text{ V}$ , see Figure 18
	$\pm 0.25$	$\pm 3$	$\pm 25$	nA max	
Drain Off Leakage, $I_D$ (Off)	$\pm 0.01$			nA typ	$V_S = 4.5\text{ V}/1\text{ V}$ , $V_D = 1\text{ V}/4.5\text{ V}$ , see Figure 18
	$\pm 0.25$	$\pm 3$	$\pm 25$	nA max	
Channel On Leakage, $I_D$ , $I_S$ (On)	$\pm 0.01$			nA typ	$V_S = V_D = 1\text{ V}$ , or $V_S = V_D = 4.5\text{ V}$ , see Figure 19
	$\pm 0.25$	$\pm 3$	$\pm 25$	nA max	
<b>DIGITAL INPUTS</b>					
Input High Voltage, $V_{INH}$			2.0	V min	
Input Low Voltage, $V_{INL}$			0.8	V max	
Input Current $I_{INL}$ or $I_{INH}$	0.005			$\mu\text{A}$ typ	$V_{IN} = V_{INL}$ or $V_{INH}$
			$\pm 0.1$	$\mu\text{A}$ max	
Digital Input Capacitance, $C_{IN}$	4			pF typ	
<b>DYNAMIC CHARACTERISTICS<sup>2</sup></b>					
$t_{ON}$	33			ns typ	$R_L = 50\ \Omega$ , $C_L = 35\text{ pF}$ , $V_S = 3\text{ V}$ , see Figure 20
	45	48	52	ns max	
$t_{OFF}$	11			ns typ	$R_L = 50\ \Omega$ , $C_L = 35\text{ pF}$ , $V_S = 3\text{ V}$ , see Figure 20
	16	19	21	ns max	
Break-Before-Make Time Delay, $t_{BBM}$ (ADG823 Only)	32		1	ns typ ns min	$R_L = 50\ \Omega$ , $C_L = 35\text{ pF}$ , $V_{S1} = V_{S2} = 3\text{ V}$ , see Figure 21
Charge Injection	15			pC typ	$V_S = 2.5\text{ V}$ ; $R_S = 0\ \Omega$ , $C_L = 1\text{ nF}$ , see Figure 22
Off Isolation	-52			dB typ	$R_L = 50\ \Omega$ , $C_L = 5\text{ pF}$ , $f = 1\text{ MHz}$ , see Figure 23
Channel-to-Channel Crosstalk	-82			dB typ	$R_L = 50\ \Omega$ , $C_L = 5\text{ pF}$ , $f = 1\text{ MHz}$ , see Figure 24
Bandwidth -3 dB	24			MHz typ	$R_L = 50\ \Omega$ , $C_L = 5\text{ pF}$ , see Figure 25
$C_S$ (Off)	85			pF typ	$f = 1\text{ MHz}$
$C_D$ (Off)	98			pF typ	$f = 1\text{ MHz}$
$C_D$ , $C_S$ (On)	230			pF typ	$f = 1\text{ MHz}$
<b>POWER REQUIREMENTS</b>					
$I_{DD}$	0.001			$\mu\text{A}$ typ	$V_{DD} = 5.5\text{ V}$ , digital inputs = 0 V or 5.5 V
		1.0	2.0	$\mu\text{A}$ max	

<sup>1</sup> On resistance parameters tested with  $I_S = 10\text{ mA}$ .

<sup>2</sup> Guaranteed by design, not subject to production test.

# ADG821/ADG822/ADG823

$V_{DD} = 2.7\text{ V to }3.6\text{ V}$ ,  $GND = 0\text{ V}$ ,  $T_A = -40^\circ\text{C to }+125^\circ\text{C}$ , unless otherwise noted.

**Table 2.**

Parameter	25°C	-40°C to +85°C	-40°C to +125°C <sup>1</sup>	Unit	Test Conditions/Comments
<b>ANALOG SWITCH</b>					
Analog Signal Range			0 V to $V_{DD}$	V	
On Resistance ( $R_{ON}$ )	0.7			$\Omega$ typ	$V_S = 0\text{ V to }V_{DD}$ , $I_S = 100\text{ mA}$ , see Figure 17
	1.4	1.5	1.6	$\Omega$ max	
On Resistance Match Between Channels ( $\Delta R_{ON}$ )	0.16			$\Omega$ typ	$V_S = 0\text{ V to }V_{DD}$ , $I_S = 100\text{ mA}$
	0.2	0.25	0.28	$\Omega$ max	
On Resistance Flatness ( $R_{FLAT(ON)}$ )	0.3		0.33	$\Omega$ typ	$V_S = 0\text{ V to }V_{DD}$ , $I_S = 100\text{ mA}$
<b>LEAKAGE CURRENTS</b>					
Source Off Leakage, $I_S$ (Off)	$\pm 0.01$			nA typ	$V_{DD} = 3.6\text{ V}$ $V_S = 3.3\text{ V}/1\text{ V}$ , $V_D = 1\text{ V}/3.3\text{ V}$ , see Figure 18
	$\pm 0.25$	$\pm 3$	$\pm 15$	nA max	
Drain Off Leakage, $I_D$ (Off)	$\pm 0.01$			nA typ	$V_S = 3.3\text{ V}/1\text{ V}$ , $V_D = 1\text{ V}/3.3\text{ V}$ , see Figure 18
	$\pm 0.25$	$\pm 3$	$\pm 25$	nA max	
Channel On Leakage, $I_D$ , $I_S$ (On)	$\pm 0.01$			nA typ	$V_S = V_D = 1\text{ V}$ , or $3.3\text{ V}$ , see Figure 19
	$\pm 0.25$	$\pm 3$	$\pm 25$	nA max	
<b>DIGITAL INPUTS</b>					
Input High Voltage, $V_{INH}$			2.0	V min	
Input Low Voltage, $V_{INL}$			0.8	V max	
Input Current $I_{INL}$ or $I_{INH}$	0.005			$\mu\text{A}$ typ	$V_{IN} = V_{INL}$ or $V_{INH}$
			$\pm 0.1$	$\mu\text{A}$ max	
Digital Input Capacitance, $C_{IN}$	4			pF typ	
<b>DYNAMIC CHARACTERISTICS<sup>2</sup></b>					
$t_{ON}$	48			ns typ	$R_L = 50\ \Omega$ , $C_L = 35\text{ pF}$ , $V_S = 1.5\text{ V}$ , see Figure 20
	67	74	78	ns max	
$t_{OFF}$	12			ns typ	$R_L = 50\ \Omega$ , $C_L = 35\text{ pF}$ , $V_S = 1.5\text{ V}$ , see Figure 20
	18	20	23	ns max	
Break-Before-Make Time Delay, $t_{BBM}$ (ADG823 Only)	40		1	ns typ ns min	$R_L = 50\ \Omega$ , $C_L = 35\text{ pF}$ , $V_{S1} = V_{S2} = 1.5\text{ V}$ , see Figure 21
Charge Injection	$\pm 2$			pC typ	$V_S = 1.5\text{ V}$ ; $R_S = 0\ \Omega$ , $C_L = 1\text{ nF}$ , see Figure 22
Off Isolation	-52			dB typ	$R_L = 50\ \Omega$ , $C_L = 5\text{ pF}$ , $f = 1\text{ MHz}$ , see Figure 23
Channel-to-Channel Crosstalk	-82			dB typ	$R_L = 50\ \Omega$ , $C_L = 5\text{ pF}$ , $f = 1\text{ MHz}$ , see Figure 24
Bandwidth -3 dB	24			MHz typ	$R_L = 50\ \Omega$ , $C_L = 5\text{ pF}$ , see Figure 25
$C_S$ (Off)	85			pF typ	$f = 1\text{ MHz}$
$C_D$ (Off)	98			pF typ	$f = 1\text{ MHz}$
$C_D$ , $C_S$ (On)	230			pF typ	$f = 1\text{ MHz}$
<b>POWER REQUIREMENTS</b>					
$I_{DD}$	0.001			$\mu\text{A}$ typ	$V_{DD} = 3.6\text{ V}$ , digital inputs = 0 V or 3.6 V
		1.0	2.0	$\mu\text{A}$ max	

<sup>1</sup> On resistance parameters tested with  $I_S = 10\text{ mA}$ .

<sup>2</sup> Guaranteed by design, not subject to production test.

## ABSOLUTE MAXIMUM RATINGS

T<sub>A</sub> = 25°C, unless otherwise noted.

Table 3.

Parameter	Rating
V <sub>DD</sub> to GND	−0.3 V to +7 V
Analog Inputs <sup>1</sup>	−0.3 V to V <sub>DD</sub> + 0.3 V or 30 mA, whichever occurs first
Digital Inputs <sup>1</sup>	−0.3 V to V <sub>DD</sub> + 0.3 V or 30 mA, whichever occurs first
Peak Current, S or D	400 mA (pulsed at 1 ms, 10% duty cycle maximum)
Continuous Current, S or D	200 mA
Operating Temperature Range	
Automotive	−40°C to +125°C
Storage Temperature Range	−65°C to +150°C
Junction Temperature (T <sub>J</sub> max)	150°C
Package Power Dissipation	(T <sub>J</sub> max − T <sub>A</sub> )/θ <sub>JA</sub>
8-Lead MSOP Thermal Impedance	
θ <sub>JA</sub>	206°C/W
θ <sub>JC</sub>	44°C/W
Lead Temperature, Soldering (10 sec)	300°C
IR Reflow, Peak Temperature (<20 sec)	235°C

<sup>1</sup> Overvoltages at IN, S, or D are clamped by internal diodes. Current should be limited to the maximum ratings given.

Stresses above those listed under Absolute Maximum Ratings may cause permanent damage to the device. This is a stress rating only; functional operation of the device at these or any other conditions above those indicated in the operational section of this specification is not implied. Exposure to absolute maximum rating conditions for extended periods may affect device reliability.

Table 4. Truth Table for the ADG821/ADG822

ADG821 INx	ADG822 INx	Switch x Condition
0	1	Off
1	0	On

Table 5. Truth Table for the ADG823

IN1	IN2	Switch S1	Switch S2
0	0	Off	On
0	1	Off	Off
1	0	On	On
1	1	On	Off

### ESD CAUTION



**ESD (electrostatic discharge) sensitive device.** Charged devices and circuit boards can discharge without detection. Although this product features patented or proprietary protection circuitry, damage may occur on devices subjected to high energy ESD. Therefore, proper ESD precautions should be taken to avoid performance degradation or loss of functionality.

# ADG821/ADG822/ADG823

## PIN CONFIGURATION AND FUNCTION DESCRIPTIONS



Figure 4. Pin Configuration

Table 6. Pin Function Descriptions

Pin No.	Mnemonic	Description
1	S1	Source Terminal. This pin can be an input or output.
2	D1	Drain Terminal. This pin can be an input or output.
3	IN2	Logic Control Input.
4	GND	Ground (0 V) Reference.
5	S2	Source Terminal. This pin can be an input or output.
6	D2	Drain Terminal. This pin can be an input or output.
7	IN1	Logic Control Input.
8	V <sub>DD</sub>	Most Positive Power Supply Potential.

TYPICAL PERFORMANCE CHARACTERISTICS



Figure 5. On Resistance vs.  $V_D$ ,  $V_S$



Figure 8. On Resistance vs.  $V_D$ ,  $V_S$  for Different Temperatures,  $V_{DD} = 3V$



Figure 6. On Resistance vs.  $V_D$ ,  $V_S$ ;  $V_{DD} = 1.8V$



Figure 9. Leakage Current vs. Temperature

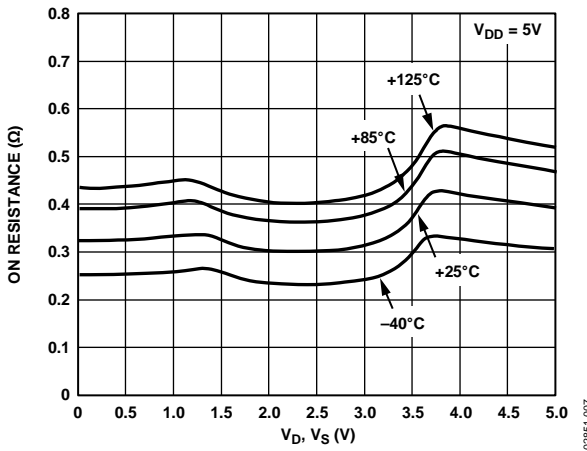

Figure 7. On Resistance vs.  $V_D$ ,  $V_S$  for Different Temperatures,  $V_{DD} = 5V$

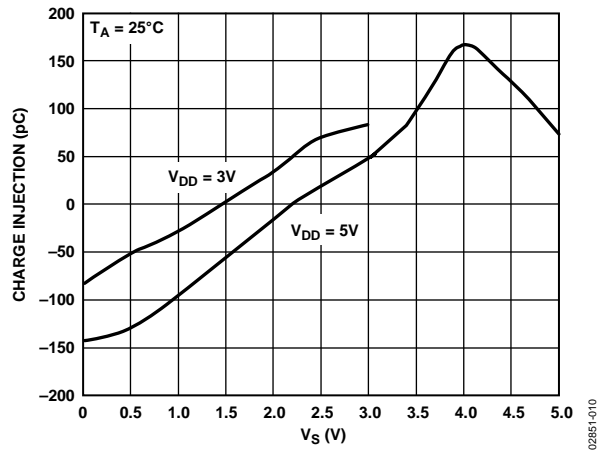

Figure 10. Charge Injection vs. Source Voltage

# ADG821/ADG822/ADG823



Figure 11.  $t_{ON}/t_{OFF}$  vs. Temperature

02851-011

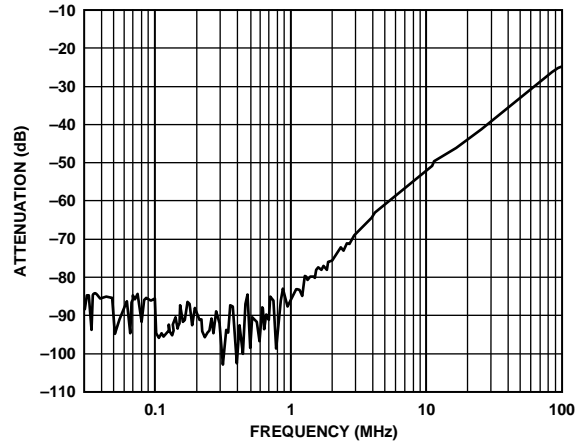

Figure 14. Crosstalk vs. Frequency

02851-014

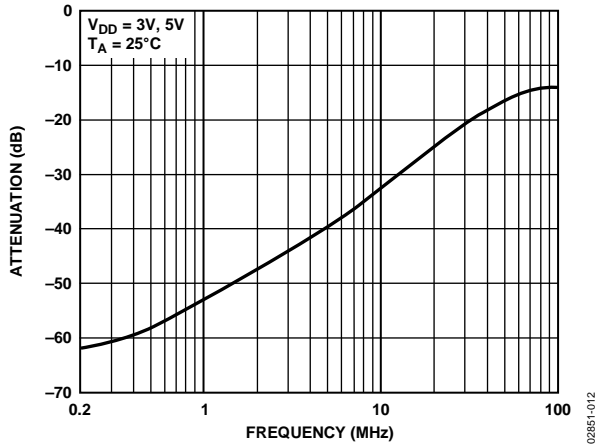

Figure 12. Off Isolation vs. Frequency

02851-012

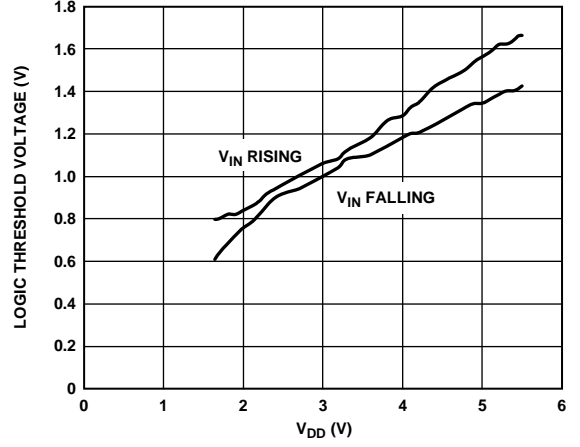

Figure 15. Logic Threshold Voltage vs. Supply Voltage

02851-015

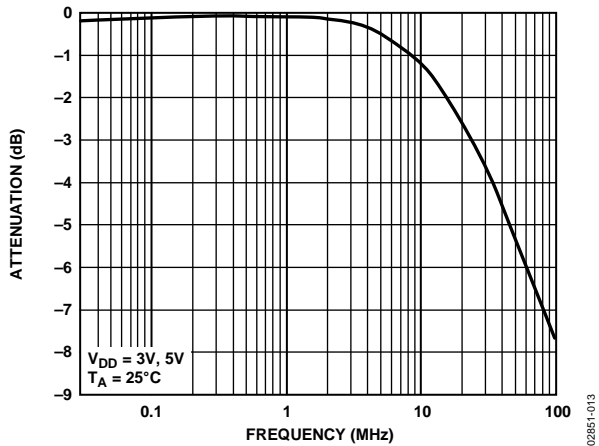

Figure 13. On Response vs. Frequency

02851-013

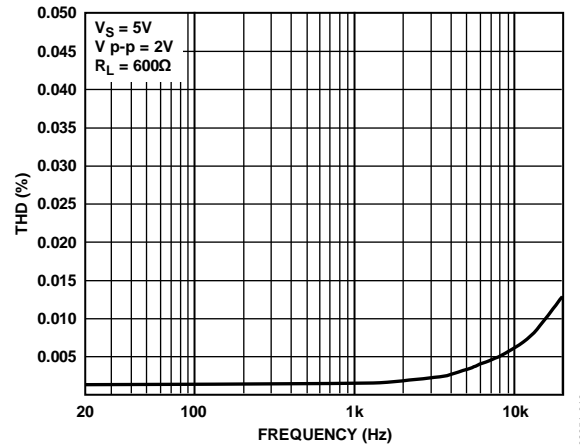

Figure 16. THD vs. Frequency

02851-016



TEST CIRCUITS

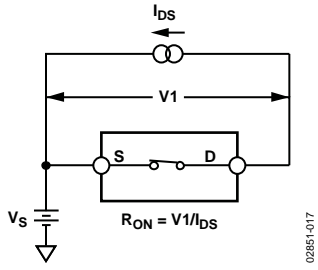

Figure 17. On Resistance

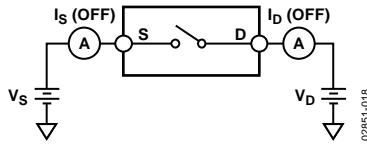

Figure 18. Off Leakage

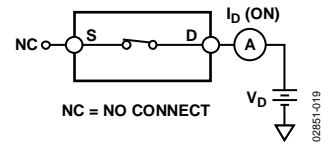

Figure 19. On Leakage

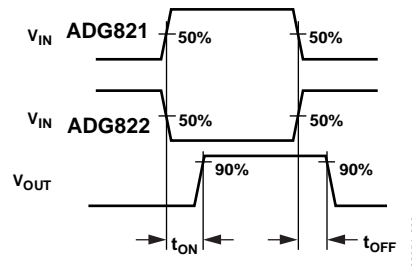

Figure 20. Switching Times

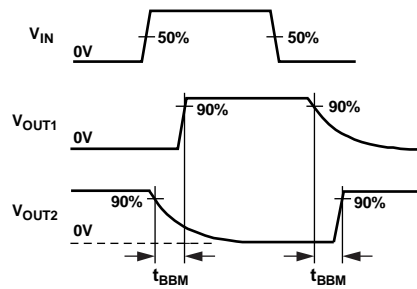

Figure 21. Break-Before-Make Time Delay,  $t_{BBM}$  (ADG823 only)

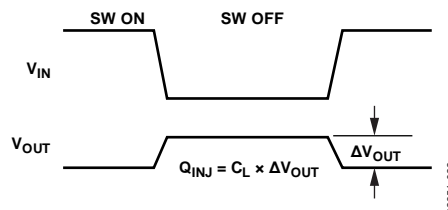
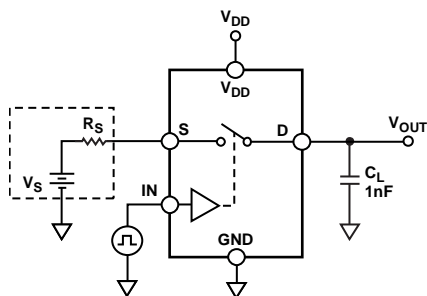

Figure 22. Charge Injection

# ADG821/ADG822/ADG823



Figure 23. Off Isolation

02851-023



Figure 25. Bandwidth

02851-025



Figure 24. Channel-to-Channel Crosstalk

02851-024

## TERMINOLOGY

$V_{DD}$

Most positive power supply potential.

**GND**

Ground (0 V) reference.

$I_{DD}$

Positive supply current.

**S**

Source terminal. May be an input or output.

**D**

Drain terminal. May be an input or output.

**IN**

Logic control input.

$R_{ON}$

Ohmic resistance between Terminal D and Terminal S.

$\Delta R_{ON}$

On resistance match between any two channels (that is,  $R_{ON\ max} - R_{ON\ min}$ ).

$R_{FLAT(ON)}$

Flatness is defined as the difference between the maximum and minimum value of on resistance as measured over the specified analog signal range.

$I_S$  (Off)

Source leakage current with the switch off.

$I_D$  (Off)

Drain leakage current with the switch off.

$I_D, I_S$  (On)

Channel leakage current with the switch on.

$V_D, V_S$

Analog voltage on Terminal D and Terminal S.

$V_{INL}$

Maximum input voltage for Logic 0.

$V_{INH}$

Minimum input voltage for Logic 1.

$I_{INL}$  ( $I_{INH}$ )

Input current of the digital input.

$C_S$  (Off)

Off switch source capacitance.

$C_D$  (Off)

Off switch drain capacitance.

$C_D, C_S$  (On)

On switch capacitance.

$t_{ON}$

Delay between applying the digital control input and the output switching on.

$t_{OFF}$

Delay between applying the digital control input and the output switching off.

$t_{BBM}$

Off time or on time measured between the 90% points of both switches, when switching from one address state to another.

### Charge Injection

Charge injection is a measure of the glitch impulse transferred from the digital input to the analog output during switching.

### Crosstalk

Crosstalk is a measure of unwanted signal that is coupled through from one channel to another as a result of parasitic capacitance.

### Off Isolation

A measure of unwanted signal coupling through an off switch.

### Bandwidth

The frequency at which the output is attenuated by  $-3$  dBs.

### On Response

The frequency response of the on switch.

### Insertion Loss

The loss due to the on resistance of the switch.

# ADG821/ADG822/ADG823

## OUTLINE DIMENSIONS

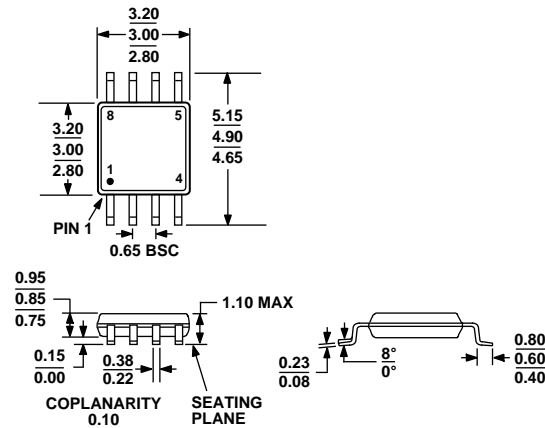

COMPLIANT TO JEDEC STANDARDS MO-187-AA

Figure 26. 8-Lead Mini Small Outline Package [MSOP]  
(RM-8)

Dimensions shown in millimeters

## ORDERING GUIDE

Model	Temperature Range	Package Description	Package Option	Branding
ADG821BRM	-40°C to +125°C	8-Lead Mini Small Outline Package [MSOP]	RM-8	SQB
ADG821BRM-REEL	-40°C to +125°C	8-Lead Mini Small Outline Package [MSOP]	RM-8	SQB
ADG821BRMZ <sup>1</sup>	-40°C to +125°C	8-Lead Mini Small Outline Package [MSOP]	RM-8	SOP
ADG821BRMZ-REEL <sup>7</sup>	-40°C to +125°C	8-Lead Mini Small Outline Package [MSOP]	RM-8	SOP
ADG822BRM	-40°C to +125°C	8-Lead Mini Small Outline Package [MSOP]	RM-8	SRB
ADG822BRM-REEL	-40°C to +125°C	8-Lead Mini Small Outline Package [MSOP]	RM-8	SRB
ADG822BRM-REEL7	-40°C to +125°C	8-Lead Mini Small Outline Package [MSOP]	RM-8	SRB
ADG822BRMZ <sup>1</sup>	-40°C to +125°C	8-Lead Mini Small Outline Package [MSOP]	RM-8	S1J
ADG822BRMZ-REEL <sup>7</sup>	-40°C to +125°C	8-Lead Mini Small Outline Package [MSOP]	RM-8	S1J
ADG823BRM	-40°C to +125°C	8-Lead Mini Small Outline Package [MSOP]	RM-8	SSB
ADG823BRM-REEL	-40°C to +125°C	8-Lead Mini Small Outline Package [MSOP]	RM-8	SSB
ADG823BRMZ <sup>1</sup>	-40°C to +125°C	8-Lead Mini Small Outline Package [MSOP]	RM-8	SSB#
ADG823BRMZ-REEL <sup>7</sup>	-40°C to +125°C	8-Lead Mini Small Outline Package [MSOP]	RM-8	SSB#

<sup>1</sup> Z = RoHS Compliant Part, # denotes RoHS compliant product may be top or bottom marked.



**Стандарт  
Электрон  
Связь**

Мы молодая и активно развивающаяся компания в области поставок электронных компонентов. Мы поставляем электронные компоненты отечественного и импортного производства напрямую от производителей и с крупнейших складов мира.

Благодаря сотрудничеству с мировыми поставщиками мы осуществляем комплексные и плановые поставки широчайшего спектра электронных компонентов.

Собственная эффективная логистика и склад в обеспечивает надежную поставку продукции в точно указанные сроки по всей России.

Мы осуществляем техническую поддержку нашим клиентам и предпродажную проверку качества продукции. На все поставляемые продукты мы предоставляем гарантию .

Осуществляем поставки продукции под контролем ВП МО РФ на предприятия военно-промышленного комплекса России , а также работаем в рамках 275 ФЗ с открытием отдельных счетов в уполномоченном банке. Система менеджмента качества компании соответствует требованиям ГОСТ ISO 9001.

Минимальные сроки поставки, гибкие цены, неограниченный ассортимент и индивидуальный подход к клиентам являются основой для выстраивания долгосрочного и эффективного сотрудничества с предприятиями радиоэлектронной промышленности, предприятиями ВПК и научно-исследовательскими институтами России.

С нами вы становитесь еще успешнее!

**Наши контакты:**

**Телефон:** +7 812 627 14 35

**Электронная почта:** [sales@st-electron.ru](mailto:sales@st-electron.ru)

**Адрес:** 198099, Санкт-Петербург,  
Промышленная ул, дом № 19, литера Н,  
помещение 100-Н Офис 331