



High Efficiency, Constant Current Output for 8 Series LEDs Driver

Features

- Driving Up to 8 LEDs
- Auto Trigger/Release OVP Function (G5114/G5118)
- Input Voltage Range: 1.7V ~ 6.5V
- Precise Dimming Control Using PWM Signal
- 50 μ A No Switching Current
- Internal 30V Switch With 0.8 Ω Rds(on)
- Soft Start Function Included
- Up to 85% Efficiency

Applications

- White LED Backlight Display for PDA
- Pocket PC
- Smart Phones
- Handheld Devices
- Cellular Phones

Ordering Information

ORDER NUMBER	ORDER NUMBER (Pb free)	MARKING	TEMP. RANGE	PACKAGE
G5114T1U	G5114T1Uf	5114X	-40°C ~ +85°C	SOT-23-5
G5116T1U	G5116T1Uf	5116X	-40°C ~ +85°C	SOT-23-5
G5118P8U	G5118P8Uf	G5118	-40°C ~ +85°C	MSOP-8

General Description

The G5114/G5116/G5118 are high efficiency boost converters with constant current output that drives up to 8 white LEDs. The continuous LED current is set with the FB pin regulated voltage across an external sense resistor (R_s) connected from that pin to ground. A dimming PWM waveform to $\overline{\text{SHDN}}$ pin controls LED average current proportional to its duty makes the brightness of LEDs also proportional to the duty.

Low FB regulation voltage and low switch turned on resistance result in high converting efficiency from wide battery voltage range to high LED series voltage.

An over-voltage protection prevents device damage while LEDs is open. It is easy to release protection state by just put the load path closed.

Pin Configuration

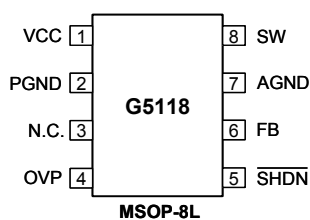
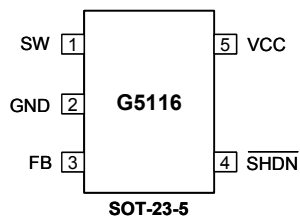
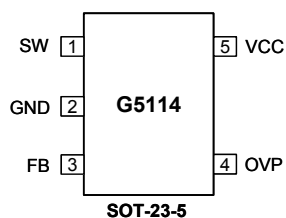

Typical Application Circuit

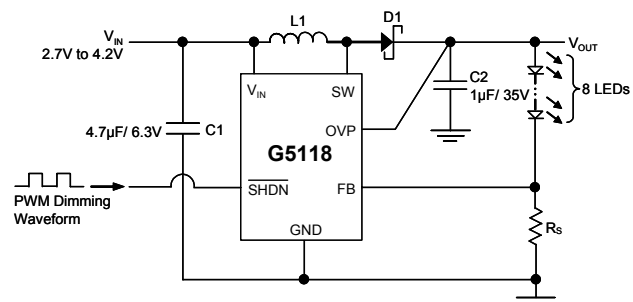



Absolute Maximum Ratings

SW, OVP to GND.....	-0.3V to +35V	Junction Temperature.....	125°C
VCC, $\overline{\text{SHDN}}$ to GND.....	-0.3V to +7V	Storage Temperature.....	-65°C to 150°C
FB to GND.....	-0.3V to VCC	Reflow Temperature (soldering, 10sec).....	260°C
Operating Temperature.....	-40°C to 85°C		

Stress beyond those listed under "Absolute Maximum Rating" may cause permanent damage to the device.

Electrical Characteristics

($V_{CC} = V_{\overline{\text{SHDN}}} = 3.6V$, $T_A = 25^\circ\text{C}$, unless specified)

PARAMETER	CONDITION	MIN	TYP	MAX	UNIT
Input Voltage Range		1.7	---	6.5	V
OV Protection Threshold	G5114/G5118, Trigger	28	29	30	V
	G5114/G5118, Release	---	---	25	V
OV Pin Input Current	G5114/G5118, $V_{ovp} = 28V$	---	10	15	μA
Quiescent Current	$V_{FB} = 0.3V$	---	50	100	μA
	$V_{\overline{\text{SHDN}}} = 0V$	---	2.4	3	μA
FB Comparator Trip Point		242	250	258	mV
Switch Off Time	$V_{FB} = 0V$	---	400	---	ns
Switch $R_{DS(ON)}$	$I_{SW} = 150\text{mA}$	---	0.8	1.2	Ω
Switch Leakage Current	Switch Off, $V_{SW} = 30V$	---	0.1	5	μA
Switch Current Limit		320	400	480	mA
$\overline{\text{SHDN}}$ Pin Voltage High		0.9	---	---	V
$\overline{\text{SHDN}}$ Pin Voltage Low		---	---	0.25	V

Note.1: The G5114/G5116/G5118 are guaranteed to meet performance specifications from 0°C~85°C. Specifications over the -40°C~85°C operating temperature range are assured by design, characterization and correlation with statistical process controls.

Block Diagram

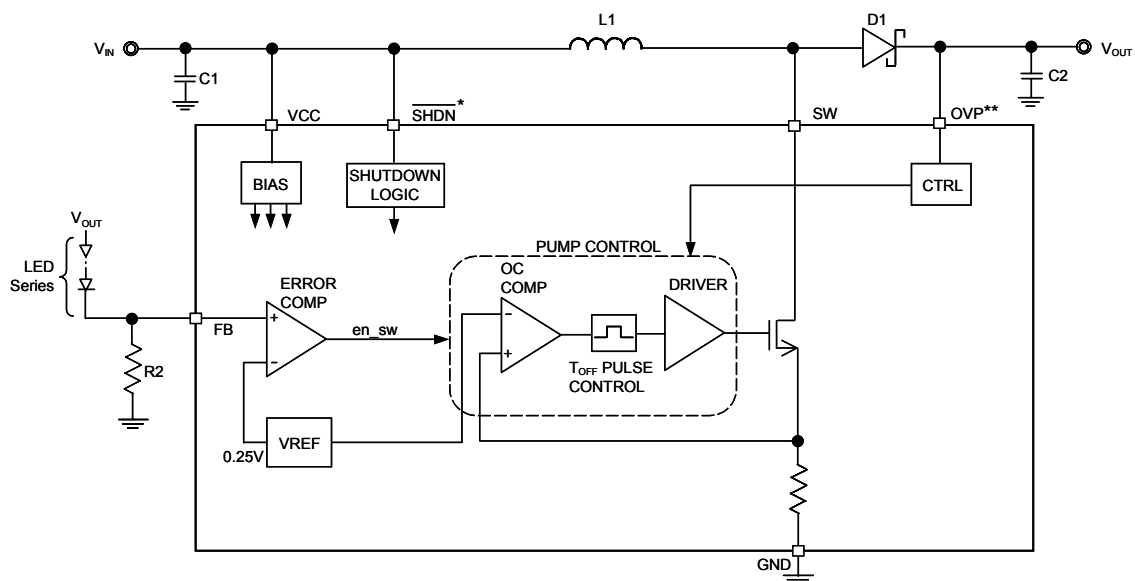

* $\overline{\text{SHDN}}$ pin only available for G5116/G5118
 ** OVP pin only available for G5114/G5118



Typical Performance Characteristics

($V_{CC} = +3.6V$, $V_{SHDN} = +3.6V$, $L=10\mu H$, $T_A=25^\circ C$, unless otherwise noted)

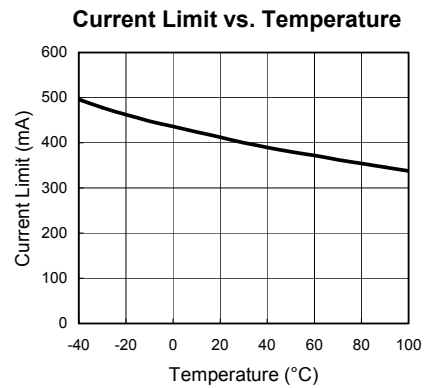
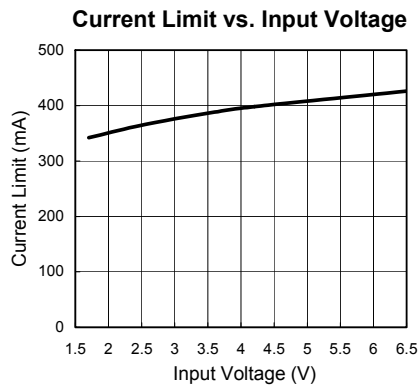
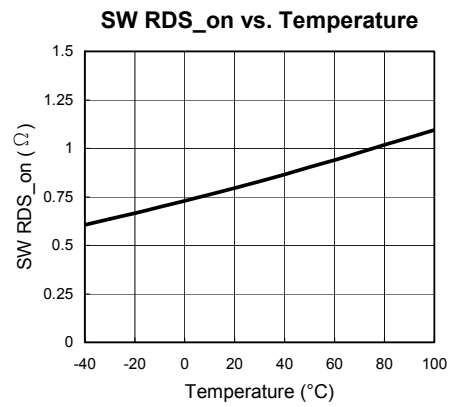
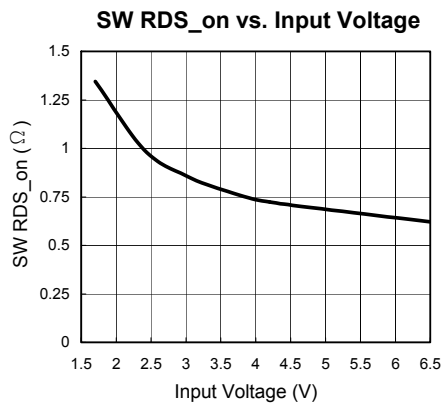
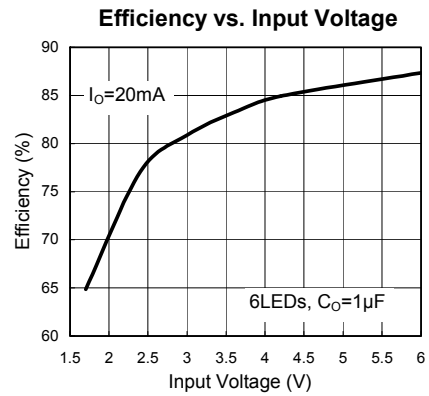
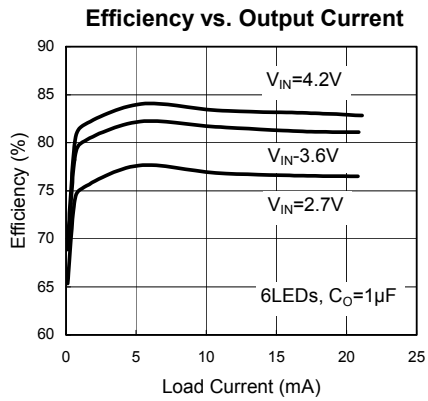



Typical Performance Characteristics (Continued)

OVP Trigger Threshold vs. Input Voltage

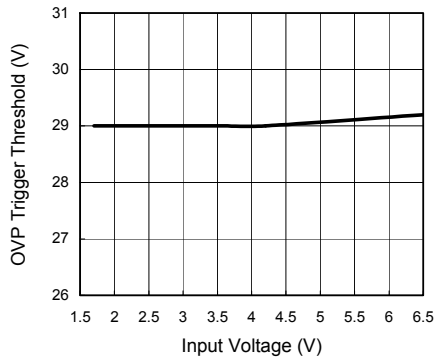

OVP Trigger Threshold vs. Temperature

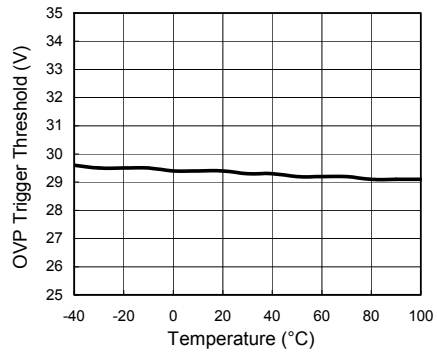

OVP Release Threshold vs. Input Voltage

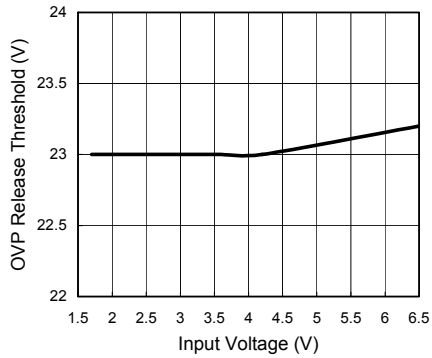

OVP Release Threshold vs. Temperature

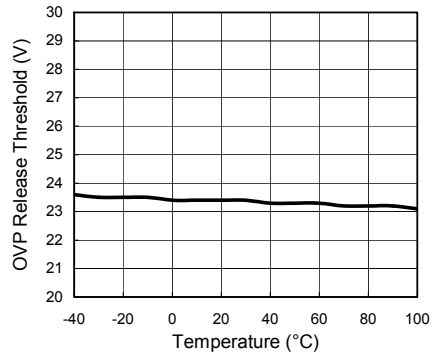

LED Current vs. Input Voltage

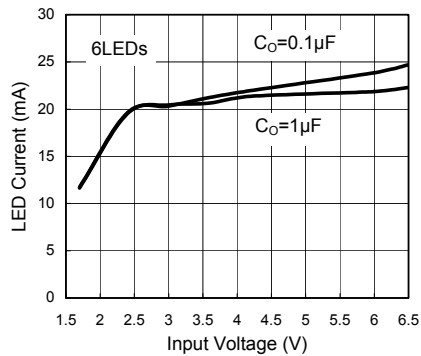

LED Current vs. Duty Cycle

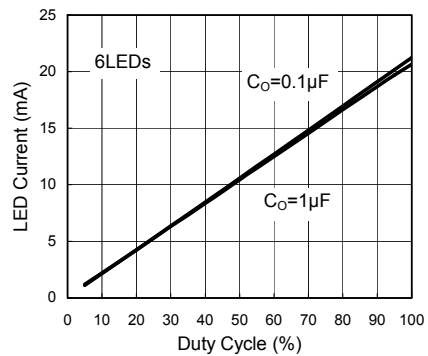



Typical Performance Characteristics (Continued)

Efficiency vs. Output Current

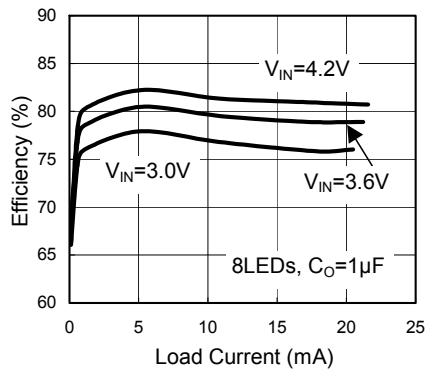

PWM Dimming

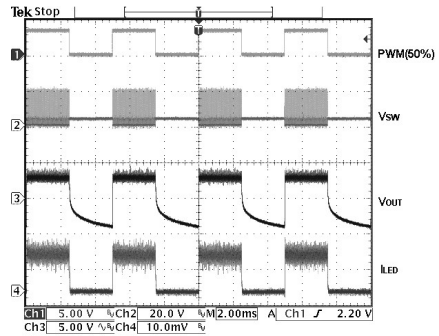

OVP Waveform

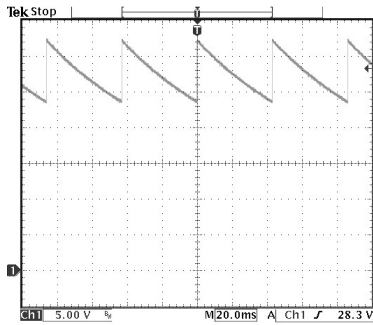

G5118 Inrush Current Waveform

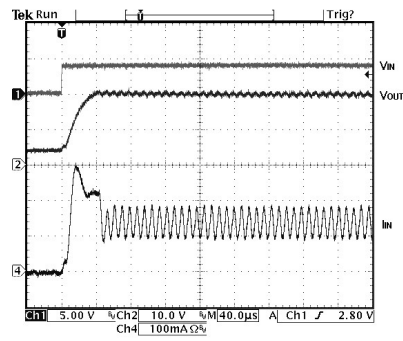

**Pin Description**

PIN			NAME	FUNCTION
G5114	G5116	G5118		
SOT-23-5	SOT-23-5	MSOP-8		
1	1	8	SW	Switch Pin. The drain of the internal NMOS power switch. Connect this pin to inductor.
2	2	2	PGND	Power Ground Pin.
		7	AGND	Analog Ground Pin.
3	3	6	FB	Feedback Pin.
	4	5	$\overline{\text{SHDN}}$	Active Low Shutdown Pin. Tie this pin to logical high to enable the device or tied it to logical low to turn this device off. Internal 1.5M Ω pulled high.
4		4	OVP	Over Voltage Protection Sense Pin.
5	5	1	VCC	Input Supply Pin. Bypass this pin with a capacitor as close to the device as possible.

Function Description**Operation**

The G5114/G5116/G5118 are boost converters with NMOS switch embedded. They operate in a PFM scheme with constant peak current control. The operation frequency is up to 1MHz and is determined by the current limit, inductor value, input voltage and minimum off time. The boost cycle is started when FB pin voltage drop below 0.25V as the NMOS switch turns on. During the switch on period, the inductor current ramps up until 400mA current limit is reached. Then turns the switch off, while the inductor current flows through external schottky diode, and ramps down to zero. During the switch off period, the inductor current provides for load current and also charges output capacitor. It makes the LED current higher and results in larger voltage drop on sense resistor Rs. The cycle stop when FB pin voltage is above 0.25V.

The current limit function acts as an inherent soft start by controlling the inrush current.

PWM Dimming

To control the brightness of the LEDs, use a low frequency PWM waveform to turn G5116/G5118 on for duty 0%~100%. How bright the LEDs at 100% duty are determined by sense resistor Rs.

Overvoltage Protection (OVP)

OVP is designed to prevent the damage of internal NMOS switch in case the increased impedance of the LED load (include the LED opened). Once the device detects over voltage at the output, the internal NMOS switch is kept off until the output voltage drops below 25V.

Applications Information**Inductor Selection**

The PFM peak current control scheme of the G5114/G5116/G5118 is inherently stable. The inductor value does not affect the stability of the regulator. The selected inductor must have a saturation current that meets the maximum peak current of the converter. Another important inductor parameter is the DC resistance. The lower DC resistance has the higher the efficiency of the converter.

Table 1. Recommended Inductors

PART	VALUE(μH)	MAX DCR (Ω)	VENDOR
LQH32CN100K1 1	10	0.39	MURATA
972AS-100M	10	0.48	TOKO
960AW-100M	10	0.18	TOKO

Output Capacitor Selection

For better output voltage filtering, a low ESR output capacitor is recommended. Ceramic capacitors have a low ESR value, but depending on the application, tantalum capacitors can be used. The selection of the output capacitor value directly influences the output voltage ripple of the converter which also influences line regulation. The larger output voltage ripple, the larger line regulation, which means that the LED current changes if the input voltage changes. If a certain change in LED current gives a noticeable change in LED brightness, depends on the LED manufacturer and on the application. Applications requiring good line regulation $\pm 1\%/V$ (TYP) must use output capacitor values $\pm 1\mu\text{F}$.



Table 2. Recommended Output Capacitors

PART	VALUE (μF)	VOLTAGE RATING (V)	VENDOR
UMK212BJ104MG	0.1	50	Tayo Yuden
GMK316BJ105KL	1	35	Tayo Yuden
GMK316F475ZG	4.7	35	Tayo Yuden

Input Capacitor Selection

For good input voltage filtering the capacitor value can be increased. Low ESR ceramic capacitors are recommended. A 4.7 μF ceramic input capacitor is sufficient for most applications.

Table 3. Recommended Input Capacitors

PART	VALUE (μF)	VOLTAGE RATING (V)	VENDOR
LMK212BJ105MG	1	10	Tayo Yuden
JMK212BJ475MG	4.7	6.3	Tayo Yuden
JMK212BJ106MG	10	6.3	Tayo Yuden

Diode Selection

To achieve high efficiency a Schottky diode must be used. The current rating of the diode must meet the peak current rating of the converter. Schottky diodes, with their low forward voltage drop and fast switching speed, are best match for the G5114/G5116/G5118.

Table 4. Recommended Diodes

PART	REVERSE VOLTAGE (V)	VENDOR
MBR0530	30	On Semiconductor

Setting The LED Current

The Converter regulates the LED current by regulating the voltage across the current sense resistor (R_S). The voltage across the sense resistor is regulated to the internal reference voltage of $V_{(FB)}=250\text{mV}$. The LED Current can be calculated:

$$I_{LED} = \frac{V_{FB}}{R_S} = \frac{0.25V}{R_S}$$

The current programming method is used when the brightness of the LEDs is fixed or control by a PWM signal applied to the $\overline{\text{SHDN}}$ pin. When using a PWM signal on the $\overline{\text{SHDN}}$ pin, the LED brightness is only dependent on the PWM duty cycle, independent of the PWM frequency or amplitude, which simplifies the systems.

Layout considerations

In all switching power supplies the layout is an important step in the design, especially at high peak currents and switching frequencies. If the layout is not carefully done, the regulator might show noise problems and duty cycle jitter. The input capacitor should be placed as close as possible to the input pin for good input voltage filtering. The inductor and diode must be placed as close as possible to the switch pin to minimize noise coupling into other circuits. Since the feedback pin and network is a high impedance circuit, the feedback network should be routed away from the inductor.



Package Information

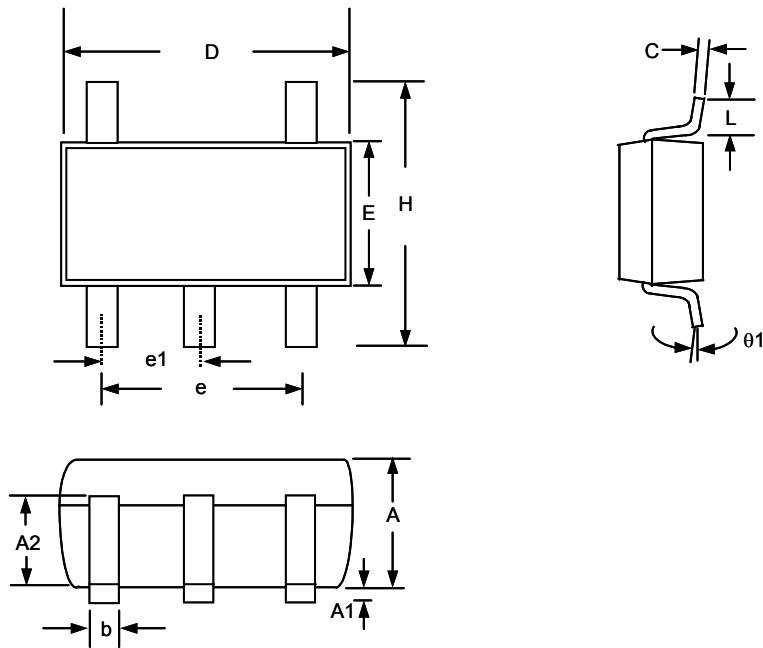

SOT-23-5 Package

Note:

1. Package body sizes exclude mold flash protrusions or gate burrs
2. Tolerance ±0.1000 mm (4mil) unless otherwise specified
3. Coplanarity: 0.1000mm
4. Dimension L is measured in gage plane

SYMBOL	DIMENSIONS IN MILLIMETER		
	MIN	NOM	MAX
A	1.00	1.10	1.30
A1	0.00	-----	0.10
A2	0.70	0.80	0.90
b	0.35	0.40	0.50
C	0.10	0.15	0.25
D	2.70	2.90	3.10
E	1.40	1.60	1.80
e	-----	1.90(TYP)	-----
e1	-----	0.95	-----
H	2.60	2.80	3.00
L	0.37	-----	-----
θ 1	1°	5°	9°

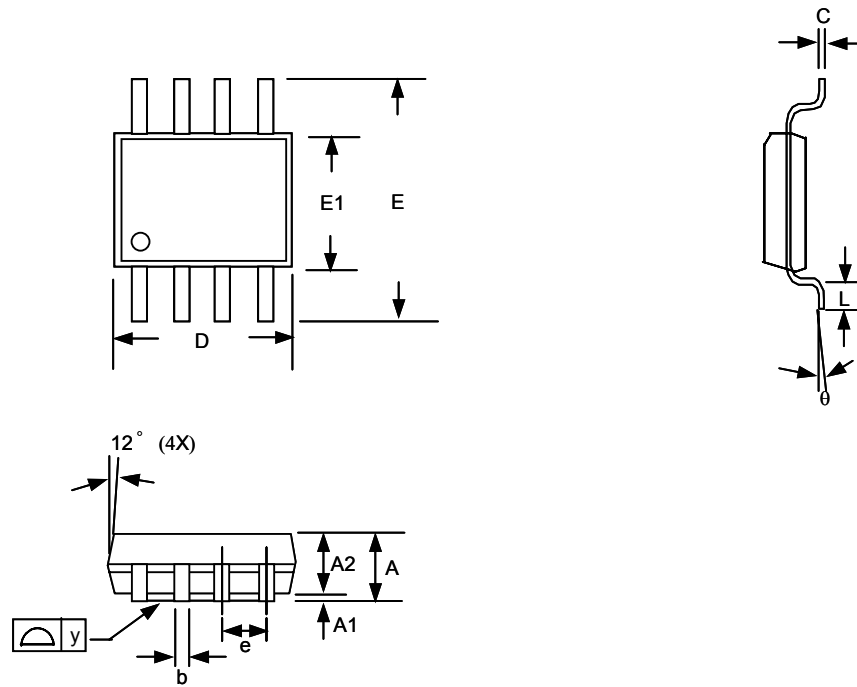

MSOP-8 Package

Note:

1. Package body sizes exclude mold flash and gate burrs
2. Dimension L is measured in gage plane
3. Tolerance 0.10mm unless otherwise specified
4. Controlling dimension is millimeter converted inch dimensions are not necessarily exact.
5. Followed from JEDEC MO-137

SYMBOL	DIMENSION IN MM			DIMENSION IN INCH		
	MIN.	NOM.	MAX.	MIN.	NOM.	MAX.
A	0.81	1.02	1.22	0.032	0.040	0.048
A1	0.00	----	0.20	0.000	----	0.008
A2	0.76	0.86	0.97	0.030	0.034	0.038
b	0.28	0.30	0.38	0.011	0.012	0.015
C	0.13	0.15	0.23	0.005	0.006	0.009
D	2.90	3.00	3.10	0.114	0.118	0.122
E	4.80	4.90	5.00	0.189	0.193	0.197
E1	2.90	3.00	3.10	0.114	0.118	0.122
e	----	0.65	----	----	0.026	----
L	0.40	0.53	0.66	0.016	0.021	0.026
y	----	----	0.10	----	----	0.004
θ	0°	----	6°	0°	----	6°

Taping Specification

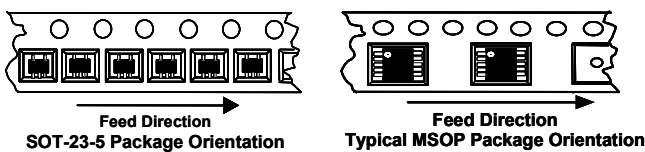

PACKAGE	Q'TY/BY REEL
SOT-23-5	3,000 ea
MSOP-8	2,500 ea

GMT Inc. does not assume any responsibility for use of any circuitry described, no circuit patent licenses are implied and GMT Inc. reserves the right at any time without notice to change said circuitry and specifications.



**Стандарт
Электрон
Связь**

Мы молодая и активно развивающаяся компания в области поставок электронных компонентов. Мы поставляем электронные компоненты отечественного и импортного производства напрямую от производителей и с крупнейших складов мира.

Благодаря сотрудничеству с мировыми поставщиками мы осуществляем комплексные и плановые поставки широчайшего спектра электронных компонентов.

Собственная эффективная логистика и склад в обеспечивает надежную поставку продукции в точно указанные сроки по всей России.

Мы осуществляем техническую поддержку нашим клиентам и предпродажную проверку качества продукции. На все поставляемые продукты мы предоставляем гарантию .

Осуществляем поставки продукции под контролем ВП МО РФ на предприятия военно-промышленного комплекса России , а также работаем в рамках 275 ФЗ с открытием отдельных счетов в уполномоченном банке. Система менеджмента качества компании соответствует требованиям ГОСТ ISO 9001.

Минимальные сроки поставки, гибкие цены, неограниченный ассортимент и индивидуальный подход к клиентам являются основой для выстраивания долгосрочного и эффективного сотрудничества с предприятиями радиоэлектронной промышленности, предприятиями ВПК и научно-исследовательскими институтами России.

С нами вы становитесь еще успешнее!

Наши контакты:

Телефон: +7 812 627 14 35

Электронная почта: sales@st-electron.ru

Адрес: 198099, Санкт-Петербург,
Промышленная ул, дом № 19, литера Н,
помещение 100-Н Офис 331