



Single/Dual/Quad, Low-Cost, Single-Supply, Rail-to-Rail Op Amps with Shutdown

MAX4400-MAX4403

General Description

The MAX4400–MAX4403 low-cost, general-purpose op amps offer rail-to-rail outputs, draw only 320 μ A of quiescent current, and operate from a single +2.5V to +5.5V supply. For additional power conservation, the MAX4401 offers a low-power shutdown mode that reduces supply current to 1 μ A (max) and puts the amplifier's output in a high-impedance state. These devices deliver ± 1.4 mA of output current and are unity-gain stable with a 1MHz gain-bandwidth product driving capacitive loads up to 400pF. The MAX4400–MAX4403 are specified to +125°C, making them suitable for use in a variety of harsh environments, such as automotive applications.

The MAX4400 single amplifier is available in ultra-small 5-pin SC70 and space-saving 5-pin SOT23 packages. The single MAX4401 includes the shutdown feature and is available in a 6-pin SC70. The MAX4402 is a dual amplifier available in 8-pin SOT23, μ MAX®, and SO packages. The MAX4403 quad amplifier is packaged in a 14-pin TSSOP or SO.

Applications

Single-Supply, Zero-Crossing Detectors
Instruments and Terminals
Portable Communications
Electronic Ignition Modules
Infrared Receivers
Sensor Signal Detection

Selector Guide

PART	NO. OF AMPLIFIERS PER PACKAGE	SHUTDOWN MODE
MAX4400	1	No
MAX4401	1	Yes
MAX4402	2	No
MAX4403	4	No

μ MAX is a registered trademark of Maxim Integrated Products, Inc.

Features

- ◆ Single +2.5V to +5.5V Supply Voltage Range
- ◆ 320 μ A Quiescent Current per Amplifier
- ◆ 1 μ A (max) Shutdown Mode (MAX4401)
- ◆ Available in Space-Saving Packages
 - 5-Pin SC70 (MAX4400)
 - 6-Pin SC70 (MAX4401)
 - 8-Pin SOT23/ μ MAX (MAX4402)
- ◆ 110dB A_{VOL} with 2k Ω Load
- ◆ 0.015% THD with 2k Ω Load
- ◆ Rail-to-Rail Output Voltage Swing
- ◆ 1.4mA of Sink and Source Load Current
- ◆ Unity-Gain Stable up to $C_{LOAD} = 400$ pF
- ◆ Ground-Sensing Inputs

Ordering Information

PART	TEMP RANGE	PIN-PACKAGE	TOP MARK
MAX4400AXK+T	-40°C to +125°C	5 SC70	AAG
MAX4400AUK+T	-40°C to +125°C	5 SOT23	ADNP
MAX4401AXT+T	-40°C to +125°C	6 SC70	AAB
MAX4402AKA+T	-40°C to +125°C	8 SOT23	AADI
MAX4402AUA+	-40°C to +125°C	8 μ MAX	—
MAX4402AUA/V+T	-40°C to +125°C	8 μ MAX	—
MAX4402ASA+	-40°C to +125°C	8 SO	—
MAX4403AUD+	-40°C to +125°C	14 TSSOP	—
MAX4403ASD+	-40°C to +125°C	14 SO	—

+Denotes a lead(Pb)-free/RoHS-compliant package.

/V denotes an automotive qualified part.

T = Tape and reel.

Pin Configurations

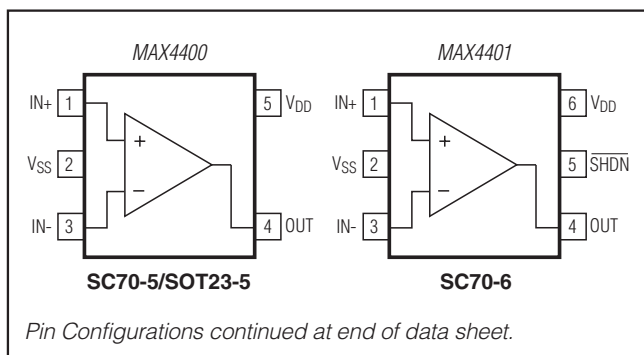

For pricing, delivery, and ordering information, please contact Maxim Direct at 1-888-629-4642, or visit Maxim's website at www.maxim-ic.com.

Single/Dual/Quad, Low-Cost, Single-Supply, Rail-to-Rail Op Amps with Shutdown

ABSOLUTE MAXIMUM RATINGS

Power-Supply Voltage (V_{DD} to V_{SS}).....	-0.3V to +6V	8-Pin μ MAX (derate 4.5mW/°C above +70°C)	362mW
All Other Pins	($V_{SS} - 0.3V$) to ($V_{DD} + 0.3V$)	8-Pin SO (derate 5.88mW/°C above +70°C).....	471mW
Output Short-Circuit Duration		14-Pin TSSOP (derate 8.33mW/°C above +70°C)	667mW
OUT Shorted to V_{SS} or V_{DD}	Continuous	14-Pin SO (derate 8.33mW/°C above +70°C).....	667mW
Continuous Power Dissipation ($T_A = +70^\circ\text{C}$)		Operating Temperature Range	-40°C to +125°C
5-Pin SC70 (derate 2.5mW/°C above +70°C).....	200mW	Storage Temperature Range	-65°C to +150°C
5-Pin SOT23 (derate 7.1mW/°C above +70°C).....	571mW	Lead Temperature (soldering, 10s).....	+300°C
6-Pin SC70 (derate 2.27mW/°C above +70°C).....	181mW	Soldering Temperature (reflow)	+260°C
8-Pin SOT23 (derate 7.52mW/°C above +70°C).....	602mW		

Stresses beyond those listed under "Absolute Maximum Ratings" may cause permanent damage to the device. These are stress ratings only, and functional operation of the device at these or any other conditions beyond those indicated in the operational sections of the specifications is not implied. Exposure to absolute maximum rating conditions for extended periods may affect device reliability.

ELECTRICAL CHARACTERISTICS

($V_{DD} = +5V$, $V_{SS} = 0V$, $V_{CM} = 0V$, $V_{OUT} = V_{DD}/2$, $R_L = \infty$ connected to $V_{DD}/2$, $\overline{SHDN} = V_{DD}$ (MAX4401 only), $T_A = +25^\circ\text{C}$, unless otherwise noted.)

PARAMETER	SYMBOL	CONDITIONS	MIN	TYP	MAX	UNITS
Supply Voltage Range	V_{DD}	Inferred from PSRR test	2.5		5.5	V
Supply Current per Amplifier	I_{DD}	$V_{DD} = 2.5V$		320		μA
		$V_{DD} = 5.0V$		410	700	
Supply Current in Shutdown	I_{SHDN}	$\overline{SHDN} = V_{SS}$ (Note 1)		0.00002	1	μA
Input Offset Voltage	V_{OS}	MAX4400/MAX4401		± 0.8	± 4.5	mV
		MAX4402/MAX4403		± 1.0	± 5.5	
Input Bias Current	I_B	(Note 2)		± 0.1	± 100	pA
Input Offset Current	I_{OS}	(Note 2)		± 0.1	± 100	pA
Input Resistance	R_{IN}	Differential or common mode		1000		G Ω
Input Common-Mode Voltage Range	V_{CM}	Inferred from CMRR test	V_{SS}		$V_{DD} - 1.4$	V
Common-Mode Rejection Ratio	CMRR	$V_{SS} \leq V_{CM} \leq V_{DD} - 1.4V$	68	84		dB
Power-Supply Rejection Ratio	PSRR	$2.5V \leq V_{DD} \leq 5.5V$	78	100		dB
Large-Signal Voltage Gain	A_{VOL}	$V_{SS} + 0.3V \leq V_{OUT} \leq V_{DD} - 0.3V$	$R_L = 100k\Omega$		120	dB
			$R_L = 2k\Omega$		90	
Output Voltage High	V_{OH}	Specified as $ V_{DD} - V_{OH} $	$R_L = 100k\Omega$		3	mV
			$R_L = 2k\Omega$		55	
Output Voltage Low	V_{OL}	Specified as $ V_{SS} - V_{OL} $	$R_L = 100k\Omega$		2	mV
			$R_L = 2k\Omega$		30	
Output Short-Circuit Current		Sourcing		12		mA
		Sinking		30		
Shutdown Mode Output Leakage	$I_{OUTSHDN}$	Device in shutdown mode, $\overline{SHDN} = V_{SS}$, $V_{SS} < V_{OUT} < V_{CC}$ (Note 1)			± 1.0	μA
\overline{SHDN} Logic Low	V_{IL}	(Note 1)		$0.3 \times V_{DD}$		V
\overline{SHDN} Logic High	V_{IH}	(Note 1)	$0.7 \times V_{DD}$			V
\overline{SHDN} Input Current	I_{IL}, I_{IH}	$\overline{SHDN} = V_{DD}$ or V_{SS} (Note 1)		± 0.001	± 500	nA
Gain-Bandwidth Product	GBW			800		kHz
Phase Margin	ϕ_M			70		degrees
Gain Margin				20		dB
Slew Rate	SR			1		V/ μs

Single/Dual/Quad, Low-Cost, Single-Supply, Rail-to-Rail Op Amps with Shutdown

MAX4400-MAX4403

ELECTRICAL CHARACTERISTICS (continued)

($V_{DD} = +5V$, $V_{SS} = 0V$, $V_{CM} = 0V$, $V_{OUT} = V_{DD}/2$, $R_L = \infty$ connected to $V_{DD}/2$, $\overline{SHDN} = V_{DD}$ (MAX4401 only), $T_A = +25^\circ C$, unless otherwise noted.)

PARAMETER	SYMBOL	CONDITIONS		MIN	TYP	MAX	UNITS
Input Voltage Noise Density	e_n	$f = 10kHz$			36		nV/\sqrt{Hz}
Input Current Noise Density	i_n	$f = 10kHz$			1		fA/\sqrt{Hz}
Capacitive-Load Stability	C_{LOAD}	$A_V = +1V/V$			400		pF
Shutdown Delay Time	t_{SHDN}	(Note 1)			0.4		μs
Enable Delay Time	t_{EN}	(Note 1)			6		μs
Power-On Time	t_{ON}				5		μs
Input Capacitance	C_{IN}				2.5		pF
Total Harmonic Distortion	THD	$f = 10kHz$, $V_{OUT} = 2V_{p-p}$, $A_V = +1V/V$	$R_L = 100k\Omega$		0.009		%
			$R_L = 2k\Omega$		0.015		
Settling Time to 0.1%	t_s	$V_{OUT} = 2V$ step			7		μs

ELECTRICAL CHARACTERISTICS

($V_{DD} = +5V$, $V_{SS} = 0V$, $V_{CM} = 0V$, $V_{OUT} = V_{DD}/2$, $R_L = \infty$ connected to $V_{DD}/2$, $T_A = -40^\circ C$ to $+125^\circ C$, unless otherwise noted.) (Note 3)

PARAMETER	SYMBOL	CONDITIONS		MIN	TYP	MAX	UNITS
Supply Voltage Range	V_{DD}	Inferred from PSRR test		2.5		5.5	V
Supply Current per Amplifier	I_{DD}					800	μA
Input Offset Voltage	V_{OS}	MAX4400/MAX4401				± 6.5	mV
		MAX4402/MAX4403				± 8.0	
Input Offset Voltage Drift	TC_{VOS}				± 1		$\mu V/^\circ C$
Input Bias Current	I_B	(Note 2)				± 100	pA
Input Offset Current	I_{OS}	(Note 2)				± 100	pA
Input Common-Mode Voltage Range	V_{CM}	Inferred from CMRR test		V_{SS}		$V_{DD} - 1.5$	V
Common-Mode Rejection Ratio	CMRR	$V_{SS} \leq V_{CM} \leq V_{DD} - 1.5V$		65			dB
		$V_{SS} \leq V_{CM} \leq V_{DD} - 1.0V$ $T_A = -20^\circ C$ to $+125^\circ C$		50			
Power-Supply Rejection Ratio	PSRR	$2.5V \leq V_{CC} \leq 5.5V$		74			dB
Shutdown Mode Output Leakage	$I_{OUTSHDN}$	Device in shutdown mode, $\overline{SHDN} = V_{SS}$, $V_{SS} < V_{OUT} < V_{DD}$ (Note 1)		$T_A = -40^\circ C$ to $+85^\circ C$		± 1.0	μA
				$T_A = +85^\circ C$ to $+125^\circ C$		± 5.0	
\overline{SHDN} Logic Low	V_{IL}	(Note 1)				$0.3 \times V_{DD}$	V
\overline{SHDN} Logic High	V_{IH}	(Note 1)		$0.7 \times V_{DD}$			V
\overline{SHDN} Input Current	I_{IL}, I_{IH}	$\overline{SHDN} = V_{DD}$ or V_{SS} (Notes 1, 2)				± 1000	nA
Large-Signal Voltage Gain	A_{VOL}	$V_{SS} + 0.3V \leq V_{OUT} \leq V_{DD} - 0.3V$, $R_L = 2k\Omega$		85			dB
Output Voltage High	V_{OH}	Specified as $I_{VDD} - V_{OH}$, $R_L = 2k\Omega$				250	mV
Output Voltage Low	V_{OL}	Specified as $I_{VSS} - V_{OL}$, $R_L = 2k\Omega$				100	mV

Note 1: Shutdown mode is only available in the 6-pin SC70 single op amp (MAX4401).

Note 2: Guaranteed by design.

Note 3: Specifications are 100% tested at $T_A = +25^\circ C$ (exceptions noted). All temperature limits are guaranteed by design.

Single/Dual/Quad, Low-Cost, Single-Supply, Rail-to-Rail Op Amps with Shutdown

Typical Operating Characteristics

($V_{DD} = +5V$, $V_{SS} = 0V$, $V_{CM} = V_{DD}/2$, $V_{SHDN} = 5V$, $R_L = \infty$ connected to $V_{DD}/2$, $T_A = +25^\circ C$, unless otherwise noted.)

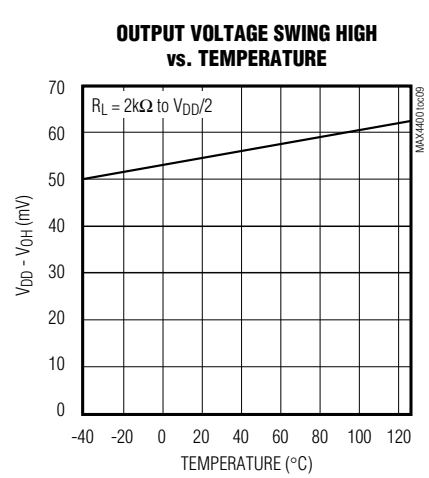
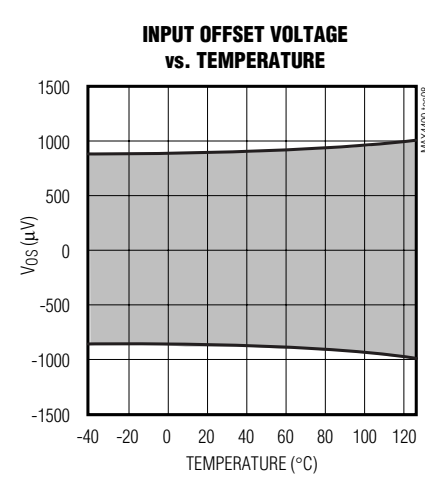
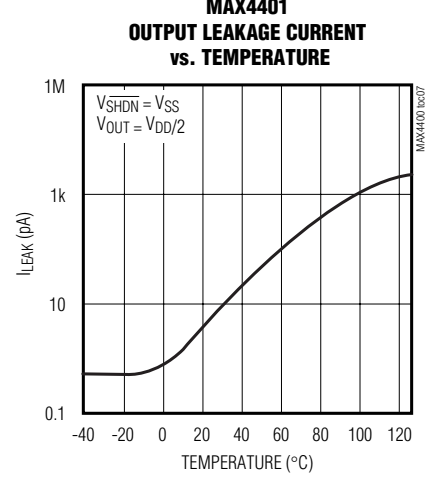
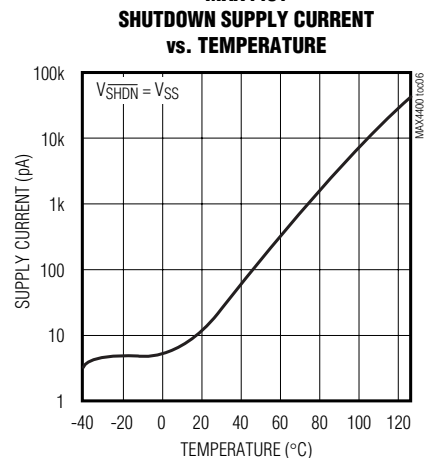
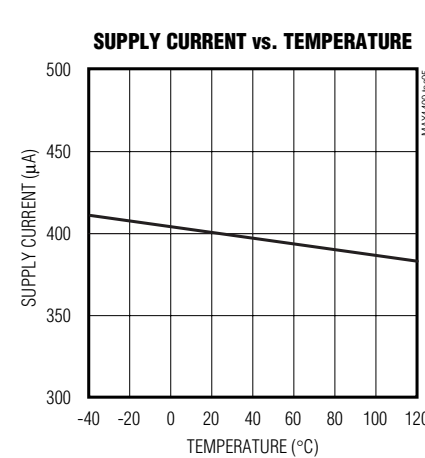
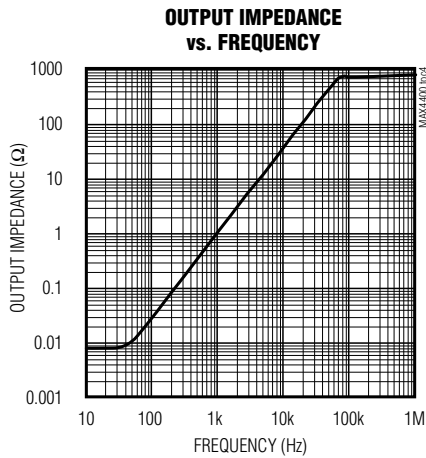
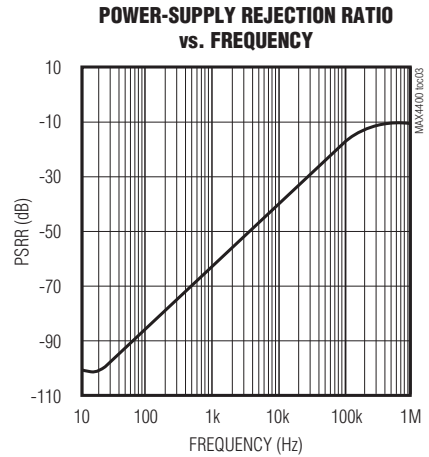
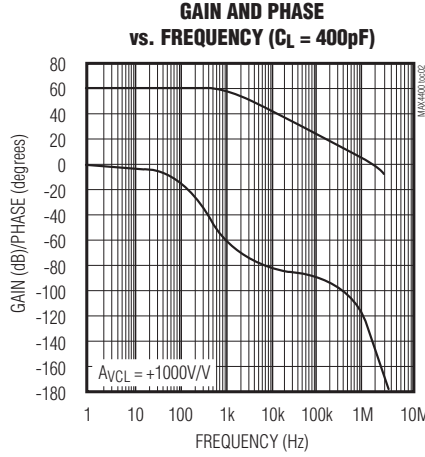
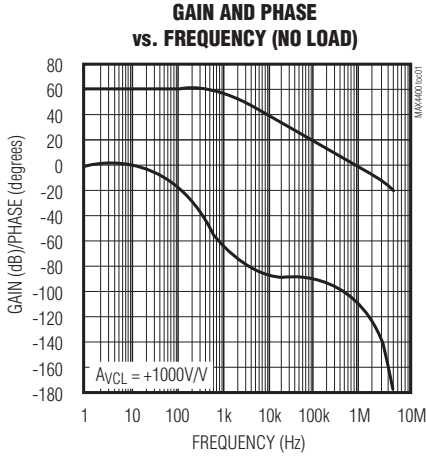

Single/Dual/Quad, Low-Cost, Single-Supply, Rail-to-Rail Op Amps with Shutdown

MAX4400-MAX4403

Typical Operating Characteristics (continued)

($V_{DD} = +5V$, $V_{SS} = 0V$, $V_{CM} = V_{DD}/2$, $V_{SHDN} = 5V$, $R_L = \infty$ connected to $V_{DD}/2$, $T_A = +25^\circ C$, unless otherwise noted.)

OUTPUT VOLTAGE SWING LOW vs. TEMPERATURE

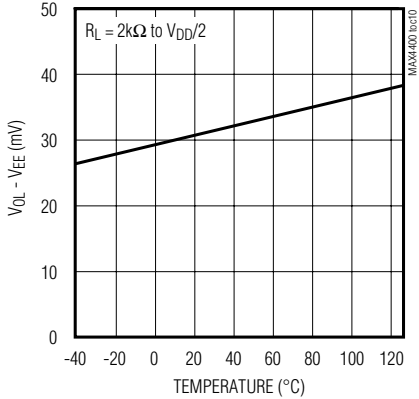

COMMON-MODE REJECTION RATIO vs. TEMPERATURE

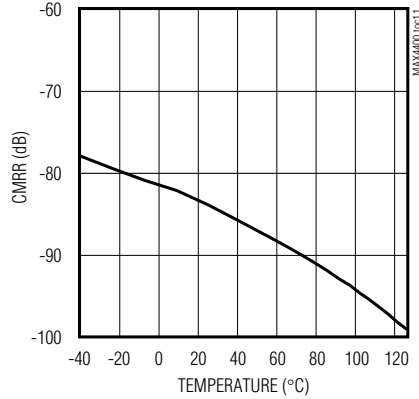

LARGE-SIGNAL GAIN vs. OUTPUT VOLTAGE

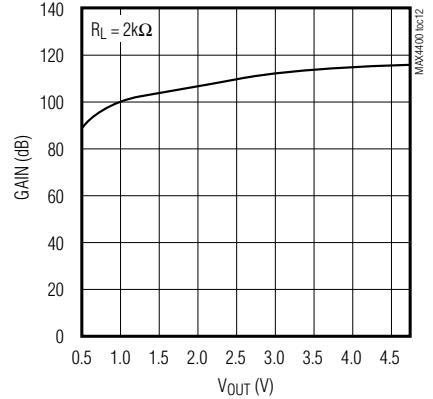

LARGE-SIGNAL GAIN vs. TEMPERATURE

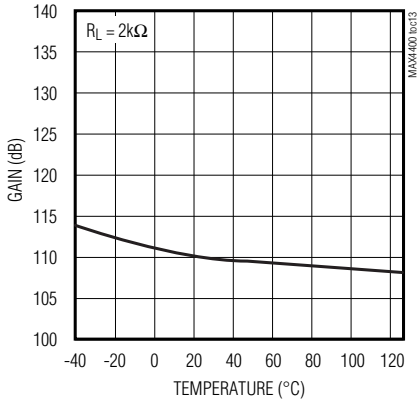

MINIMUM OPERATING VOLTAGE vs. TEMPERATURE

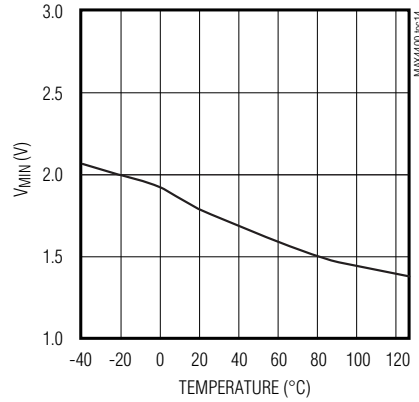

TOTAL HARMONIC DISTORTION vs. FREQUENCY

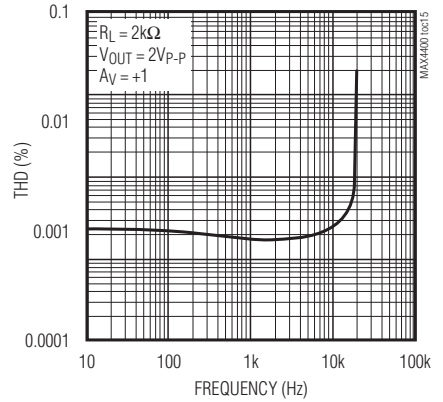

TOTAL HARMONIC DISTORTION vs. FREQUENCY

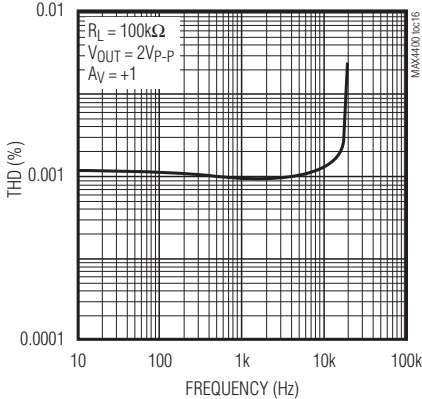

TOTAL HARMONIC DISTORTION PLUS NOISE vs. INPUT AMPLITUDE

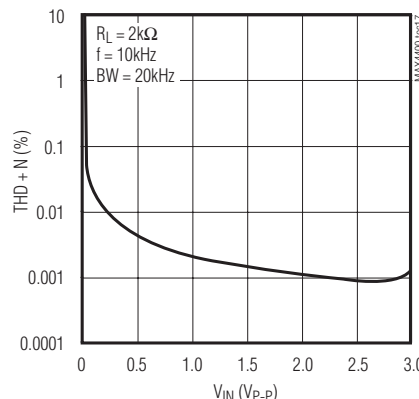

TOTAL HARMONIC DISTORTION PLUS NOISE vs. INPUT AMPLITUDE

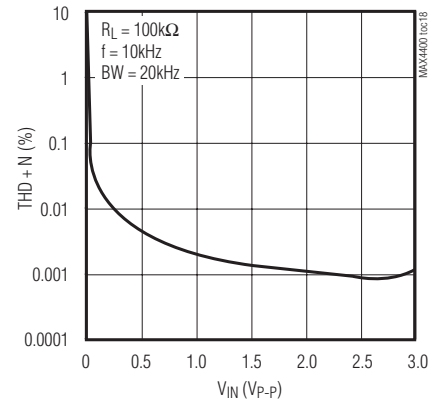

Single/Dual/Quad, Low-Cost, Single-Supply, Rail-to-Rail Op Amps with Shutdown

Typical Operating Characteristics (continued)

($V_{DD} = +5V$, $V_{SS} = 0V$, $V_{CM} = V_{DD}/2$, $V_{SHDN} = 5V$, $R_L = \infty$ connected to $V_{DD}/2$, $T_A = +25^\circ C$, unless otherwise noted.)

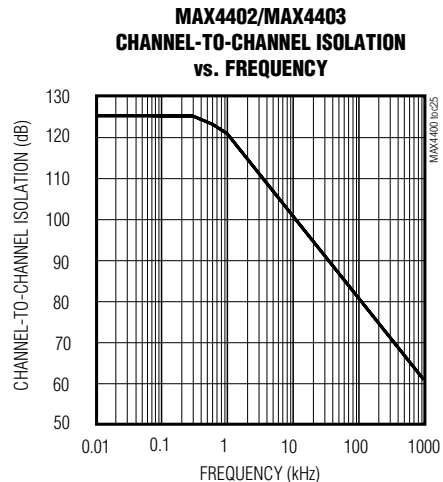
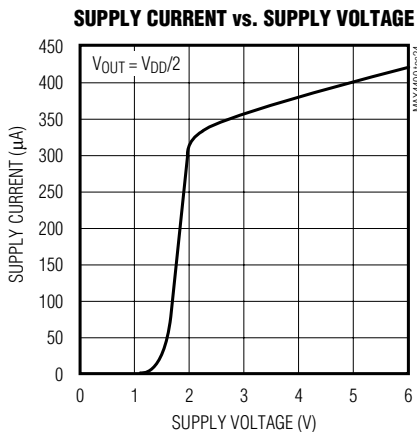
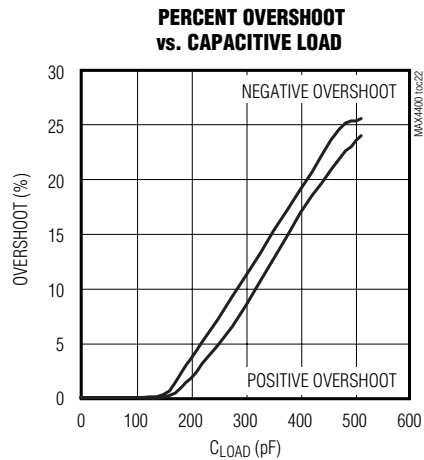
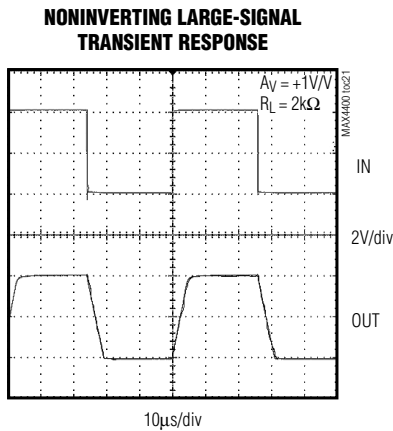
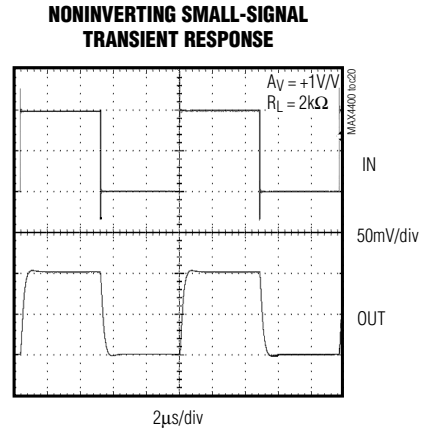
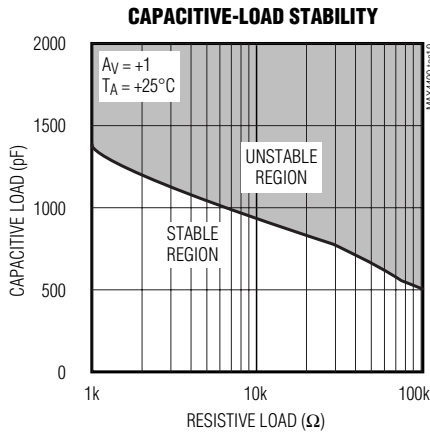

Single/Dual/Quad, Low-Cost, Single-Supply, Rail-to-Rail Op Amps with Shutdown

MAX4400-MAX4403

Pin Description

PIN				NAME	FUNCTION
MAX4400	MAX4401	MAX4402	MAX4403		
1	1	—	—	IN+	Noninverting Amplifier Input
—	—	3	3	INA+	Noninverting Amplifier Input A
—	—	5	5	INB+	Noninverting Amplifier Input B
—	—	—	10	INC+	Noninverting Amplifier Input C
—	—	—	12	IND+	Noninverting Amplifier Input D
2	2	4	11	V _{SS}	Negative Supply. Connect to ground for single-supply operation
3	3	—	—	IN-	Inverting Amplifier Input
—	—	2	2	INA-	Inverting Amplifier Input A
—	—	6	6	INB-	Inverting Amplifier Input B
—	—	—	9	INC-	Inverting Amplifier Input C
—	—	—	13	IND-	Inverting Amplifier Input D
4	4	—	—	OUT	Amplifier Output
—	—	1	1	OUTA	Amplifier Output A
—	—	7	7	OUTB	Amplifier Output B
—	—	—	8	OUTC	Amplifier Output C
—	—	—	14	OUTD	Amplifier Output D
5	6	8	4	V _{DD}	Positive Supply
—	5	—	—	$\overline{\text{SHDN}}$	Active-Low Shutdown Input. Connect to V _{DD} for normal operation. Do not leave unconnected.

Detailed Description

Rail-to-Rail Output Stage

The MAX4400-MAX4403 can drive a 2k Ω load and still typically swing within 55mV of the supply rails. Figure 1 shows the output voltage swing of the MAX4400 configured with A_v = +10V/V.

Driving Capacitive Loads

Driving a capacitive load can cause instability in many op amps, especially those with low quiescent current. The MAX4400-MAX4403 are unity-gain stable for a range of capacitive loads to above 400pF. Figure 2 shows the response of the MAX4400 with an excessive capacitive load. Adding a series resistor between the output and the load capacitor (Figure 3) improves the circuit's response by isolating the load capacitance from the op amp's output.

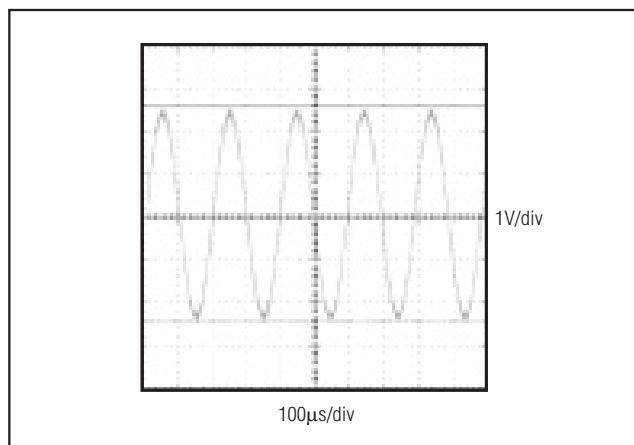

Figure 1. Rail-to-Rail Output Operation

Single/Dual/Quad, Low-Cost, Single-Supply, Rail-to-Rail Op Amps with Shutdown

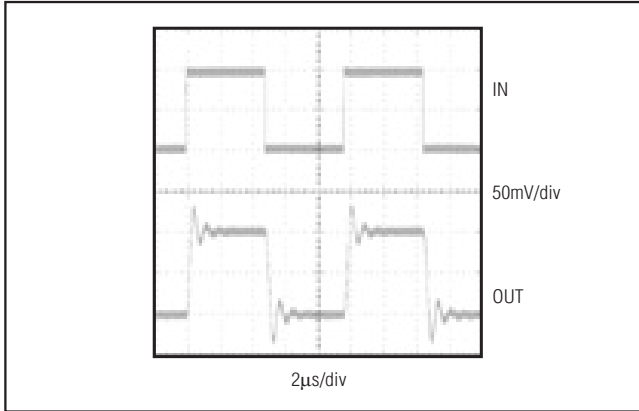

Figure 2. Small-Signal Transient Response with Excessive Capacitive Load

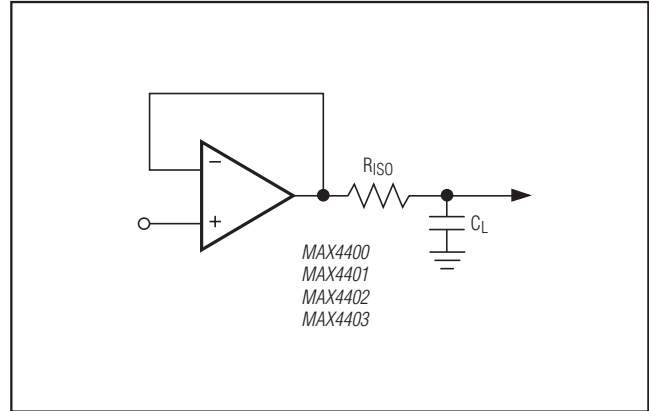

Figure 3. Capacitive-Load-Driving Circuit

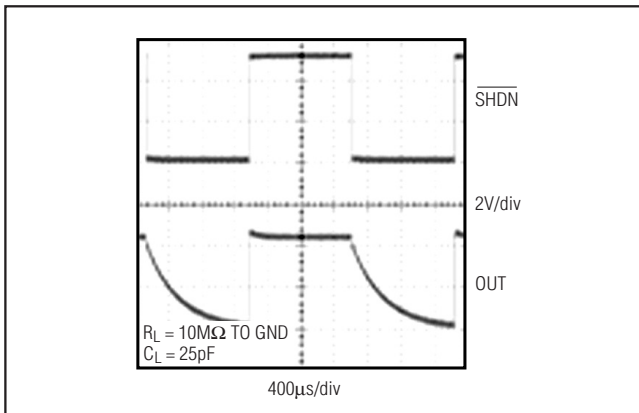

Figure 4. Shutdown Waveform

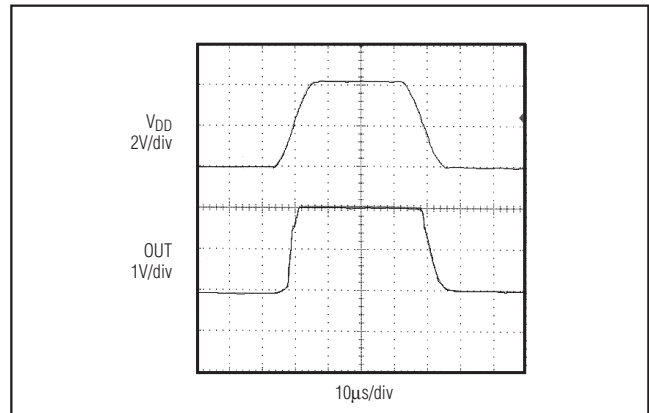

Figure 5. Power-Up/Power-Down Waveform

Applications Information

Shutdown Mode

The MAX4401 features a low-power shutdown mode. When $\overline{\text{SHDN}}$ goes low, the supply current drops to 20pA (typ) and the output enters a high-impedance state. Pull $\overline{\text{SHDN}}$ high to enable the amplifier. Do not leave $\overline{\text{SHDN}}$ unconnected. Figure 4 shows the shutdown waveform.

Power-Up

The MAX4400-MAX4403 outputs typically settle within 5µs after power-up. Figure 5 shows the output voltage on power-up and power-down.

Power Supplies and Layout

The MAX4400-MAX4403 operate from a single +2.5V to +5.5V power supply. Bypass the power supply with a 0.1µF capacitor to ground.

Good layout techniques optimize performance by decreasing the amount of stray capacitance at the op amp's inputs and outputs. To decrease stray capacitance, minimize trace lengths by placing external components close to the op amp's pins.

Single/Dual/Quad, Low-Cost, Single-Supply, Rail-to-Rail Op Amps with Shutdown

Pin Configurations (continued)

MAX4400-MAX4403

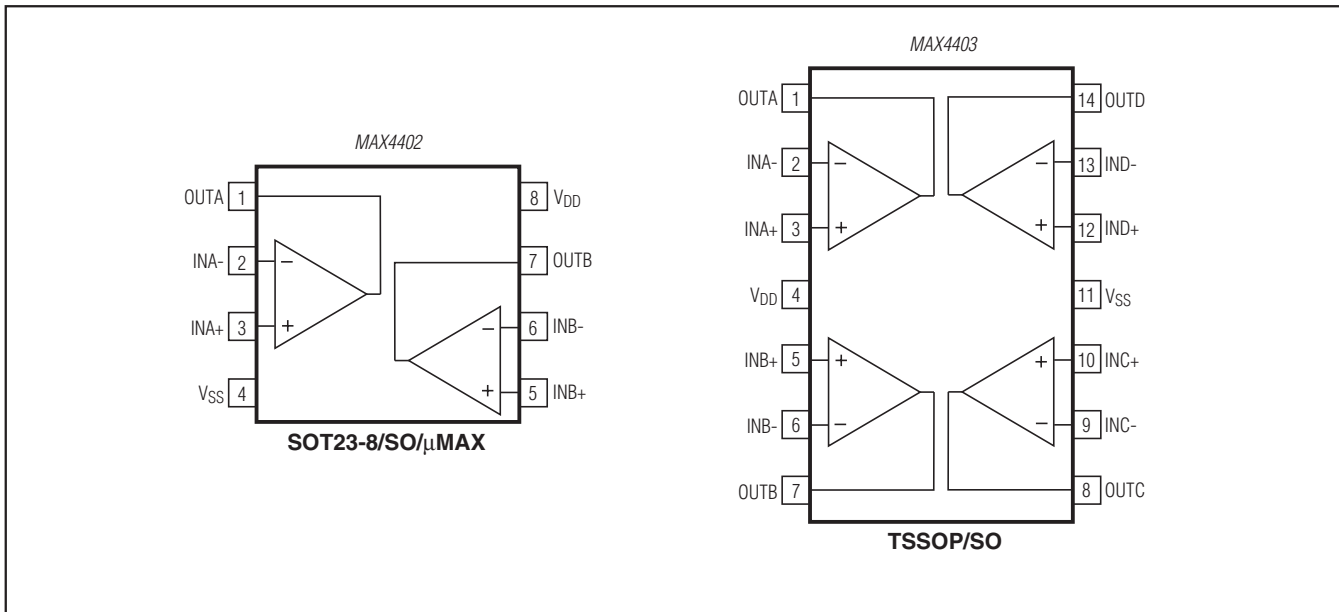

Package Information

For the latest package outline information and land patterns (footprints), go to www.maxim-ic.com/packages. Note that a "+", "#", or "-" in the package code indicates RoHS status only. Package drawings may show a different suffix character, but the drawing pertains to the package regardless of RoHS status.

PACKAGE TYPE	PACKAGE CODE	OUTLINE NO.	LAND PATTERN NO.
5 SC70	X5+1	21-0076	90-0188
5 SOT23	U5+1	21-0057	90-0174
6 SC70	X6SN+1	21-0077	90-0189
8 SOT23	K8+5	21-0078	90-0176
8 μ MAX	U8+1	21-0036	90-0092
8 SO	S8+2	21-0041	90-0096
14 TSSOP	U14+1	21-0066	90-0113
14 SO	S14+1	21-0041	90-0112

Single/Dual/Quad, Low-Cost, Single-Supply, Rail-to-Rail Op Amps with Shutdown

Revision History

REVISION NUMBER	REVISION DATE	DESCRIPTION	PAGES CHANGED
0	1/00	Initial Release	—
1	11/00	Release of MAX4402.	1, 2, 9
2	7/00	Release of MAX4403.	1, 6, 7
3	9/01	Added μ MAX package to data sheet.	1, 2, 9
4	7/12	Added automotive package for MAX4402 to data sheet.	1

Maxim cannot assume responsibility for use of any circuitry other than circuitry entirely embodied in a Maxim product. No circuit patent licenses are implied. Maxim reserves the right to change the circuitry and specifications without notice at any time. The parametric values (min and max limits) shown in the Electrical Characteristics table are guaranteed. Other parametric values quoted in this data sheet are provided for guidance.



Стандарт Электрон Связь

Мы молодая и активно развивающаяся компания в области поставок электронных компонентов. Мы поставляем электронные компоненты отечественного и импортного производства напрямую от производителей и с крупнейших складов мира.

Благодаря сотрудничеству с мировыми поставщиками мы осуществляем комплексные и плановые поставки широчайшего спектра электронных компонентов.

Собственная эффективная логистика и склад в обеспечивает надежную поставку продукции в точно указанные сроки по всей России.

Мы осуществляем техническую поддержку нашим клиентам и предпродажную проверку качества продукции. На все поставляемые продукты мы предоставляем гарантию .

Осуществляем поставки продукции под контролем ВП МО РФ на предприятия военно-промышленного комплекса России , а также работаем в рамках 275 ФЗ с открытием отдельных счетов в уполномоченном банке. Система менеджмента качества компании соответствует требованиям ГОСТ ISO 9001.

Минимальные сроки поставки, гибкие цены, неограниченный ассортимент и индивидуальный подход к клиентам являются основой для выстраивания долгосрочного и эффективного сотрудничества с предприятиями радиоэлектронной промышленности, предприятиями ВПК и научно-исследовательскими институтами России.

С нами вы становитесь еще успешнее!

Наши контакты:

Телефон: +7 812 627 14 35

Электронная почта: sales@st-electron.ru

Адрес: 198099, Санкт-Петербург,
Промышленная ул, дом № 19, литера Н,
помещение 100-Н Офис 331