

CGH40090PP

90 W, RF Power GaN HEMT

Cree's CGH40090PP is an unmatched, gallium nitride (GaN) high electron mobility transistor (HEMT). The CGH40090PP, operating from a 28 volt rail, offers a general purpose, broadband solution to a variety of RF and microwave applications. GaN HEMTs offer high efficiency, high gain and wide bandwidth capabilities making the CGH40090PP ideal for linear and compressed amplifier circuits. The transistor is available in a 4-lead flange package.

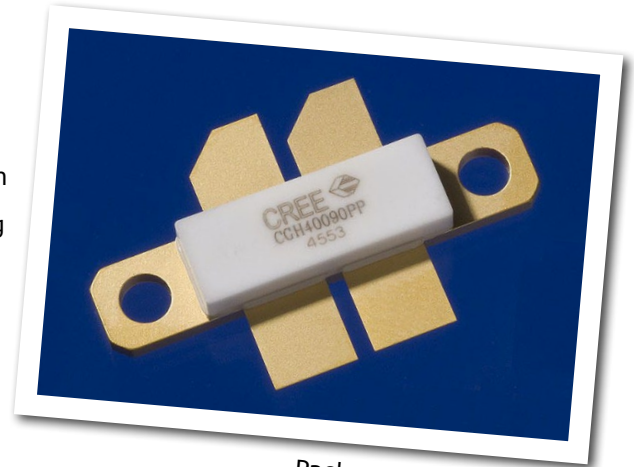

Package Types: 440199
PN: CGH40090PP

Typical Performance Over 500 MHz - 2.5 GHz ($\tau_c = 25^\circ\text{C}$) of Demonstration Amplifier

Parameter	500 MHz	1.0 GHz	1.5 GHz	2.0 GHz	2.5 GHz	Units
Small Signal Gain	17.6	15.6	14.1	12.4	12.4	dB
Gain at P_{SAT}	13.7	11.7	9.2	7.0	10.4	dB
Saturated Power	66.8	102.7	91.4	101.7	57.0	W
Drain Efficiency at P_{SAT}	48.5	57.0	56.6	59.2	37.3	%
Input Return Loss	7.3	23.0	14.9	14.3	11.3	dB

Features

- Up to 2.5 GHz Operation
- 16 dB Small Signal Gain at 2.0 GHz
- 100 W Typical P_{SAT}
- 55 % Efficiency at P_{SAT}
- 28 V Operation



Large Signal Models Available for SiC & GaN



Absolute Maximum Ratings (not simultaneous) at 25 °C Case Temperature

Parameter	Symbol	Rating	Units	Conditions
Drain-Source Voltage	V_{DSS}	84	Volts	25 °C
Gate-to-Source Voltage	V_{GS}	-10, +2	Volts	25 °C
Storage Temperature	T_{STG}	-65, +150	°C	
Operating Junction Temperature	T_J	225	°C	
Maximum Forward Gate Current	I_{GMAX}	28	mA	25 °C
Maximum Drain Current ¹	I_{DMAX}	12	A	25 °C
Soldering Temperature ²	T_S	245	°C	
Screw Torque	τ	80	in-oz	
Thermal Resistance, Junction to Case ³	$R_{\theta JC}$	1.45	°C/W	85 °C
Case Operating Temperature ^{3,4}	T_C	-40, +150	°C	30 seconds

Note:

¹ Current limit for long term, reliable operation

² Refer to the Application Note on soldering at www.cree.com/products/wireless_appnotes.asp

³ Measured for the CGH40090PP at $P_{DISS} = 112W$.

⁴ See also, the Power Dissipation De-rating Curve on Page 6.

Electrical Characteristics ($T_c = 25^\circ C$)

Characteristics	Symbol	Min.	Typ.	Max.	Units	Conditions
DC Characteristics¹						
Gate Threshold Voltage	$V_{GS(th)}$	-3.8	-3.0	-2.3	V_{DC}	$V_{DS} = 10 V, I_D = 28.8 mA$
Gate Quiescent Voltage	$V_{GS(Q)}$	-	-2.7	-	V_{DC}	$V_{DS} = 28 V, I_D = 1.0 A$
Saturated Drain Current ²	I_{DS}	23.2	28.0	-	A	$V_{DS} = 6.0 V, V_{GS} = 2.0 V$
Drain-Source Breakdown Voltage	V_{BR}	120	-	-	V_{DC}	$V_{GS} = -8 V, I_D = 28.8 mA$
RF Characteristics^{3,4} ($T_c = 25^\circ C, F_0 = 2.0 GHz$ unless otherwise noted)						
Small Signal Gain	G_{SS}	12	12.5	-	dB	$V_{DD} = 28 V, I_{DQ} = 1.0 A$
Power Output at Saturation ⁵	P_{SAT}	80	100	-	W	$V_{DD} = 28 V, I_{DQ} = 1.0 A$
Drain Efficiency ⁶	η	45	55	-	%	$V_{DD} = 28 V, I_{DQ} = 1.0 A, P_{OUT} = P_{SAT}$
Output Mismatch Stress	VSWR	-	-	10 : 1	Ψ	No damage at all phase angles, $V_{DD} = 28 V, I_{DQ} = 1.0 A,$ $P_{OUT} = 90 W CW$
Dynamic Characteristics⁷						
Input Capacitance	C_{GS}	-	19.0	-	pF	$V_{DS} = 28 V, V_{gs} = -8 V, f = 1 MHz$
Output Capacitance	C_{DS}	-	5.9	-	pF	$V_{DS} = 28 V, V_{gs} = -8 V, f = 1 MHz$
Feedback Capacitance	C_{GD}	-	0.8	-	pF	$V_{DS} = 28 V, V_{gs} = -8 V, f = 1 MHz$

Notes:

¹ Measured on wafer prior to packaging.

² Scaled from PCM data.

³ Measured in CGH40090PP-TB.

⁴ I_{DQ} of 1.0 A is by biasing each device at 0.5 A.

⁵ P_{SAT} is defined as: Q1 or Q2 = $I_G = 14 mA$.

⁶ Drain Efficiency = P_{OUT} / P_{DC}

⁷ Capacitance values are for each side of the device.

Typical Performance

Gain and Efficiency vs Output Power of the CGH40090PP measured in Broadband Amplifier Circuit CGH40090PP-TB
 $V_{DD} = 28\text{ V}$, $I_{DQ} = 1.0\text{ A}$, Freq = 0.5 - 2.5 GHz

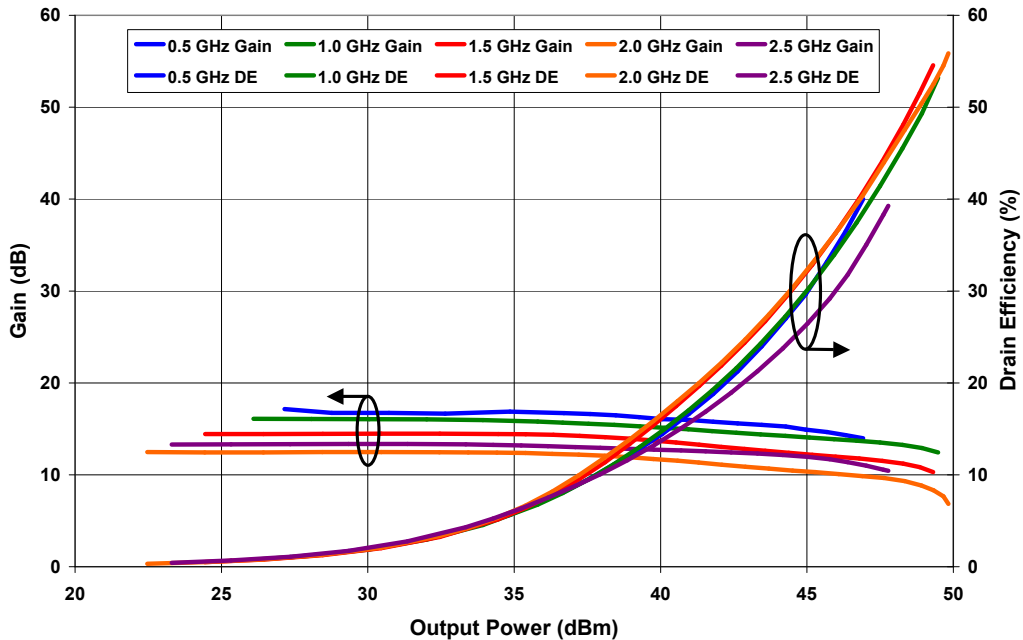

Output Power and Drain Efficiency vs Frequency of the CGH40090PP measured in Broadband Amplifier Circuit CGH40090PP-TB
 $V_{DD} = 28\text{ V}$, $I_{DQ} = 1.0\text{ A}$

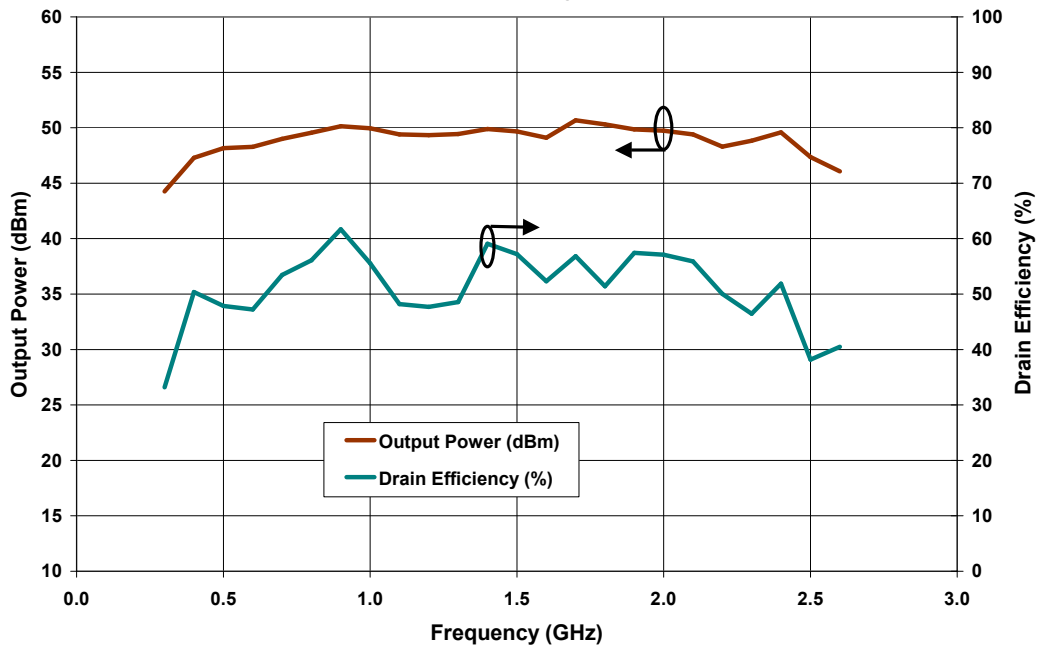

Typical Performance

**Gain and Input Return Loss vs Frequency from 0.5 GHz to 2.5 GHz
in Broadband Amplifier Circuit CGH40090PP-TB**
 $V_{DD} = 28\text{ V}, I_{DQ} = 1.0\text{ A}$

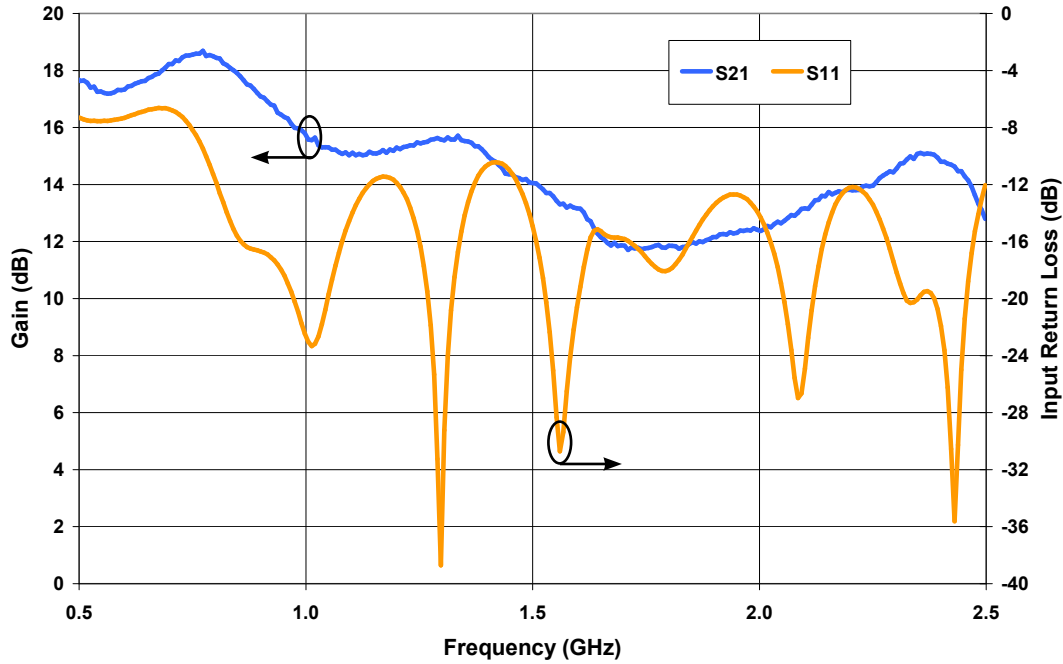

Maximum Available Gain and K Factor of the CGH40090PP
 $V_{DD} = 28\text{ V}, I_{DQ} = 1.0\text{ A}$

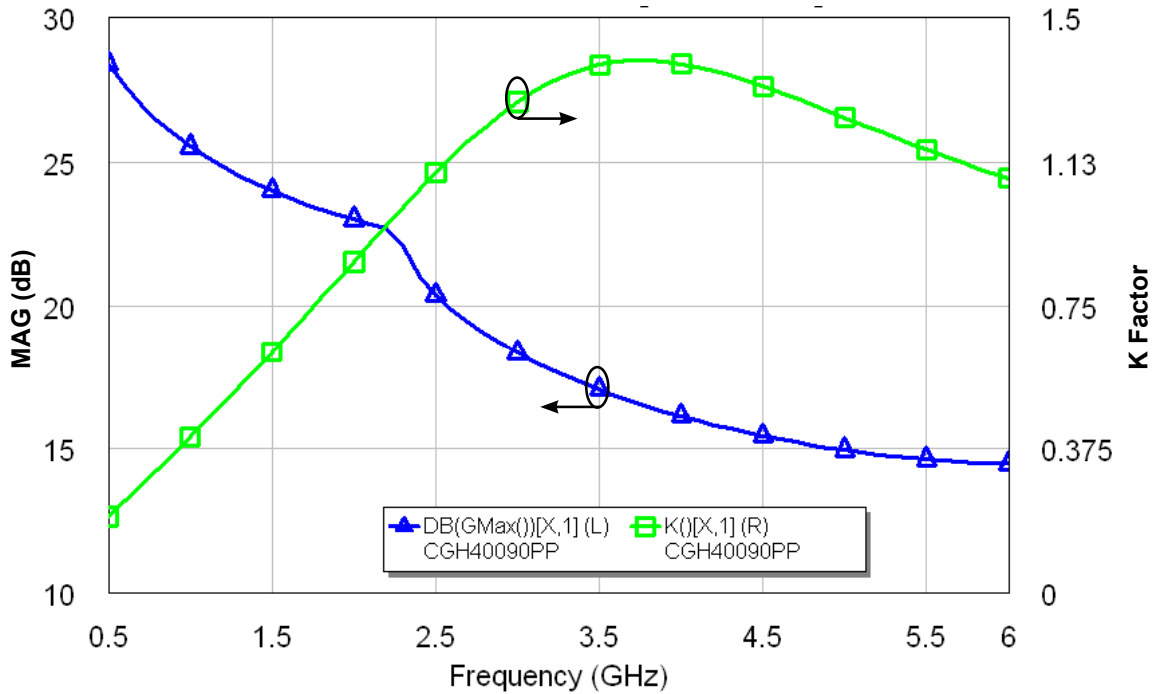

Typical Noise Performance

Simulated Minimum Noise Figure and Noise Resistance vs Frequency of the CGH40090PP
 $V_{DD} = 28\text{ V}$, $I_{DQ} = 500\text{ mA}$ (per side)

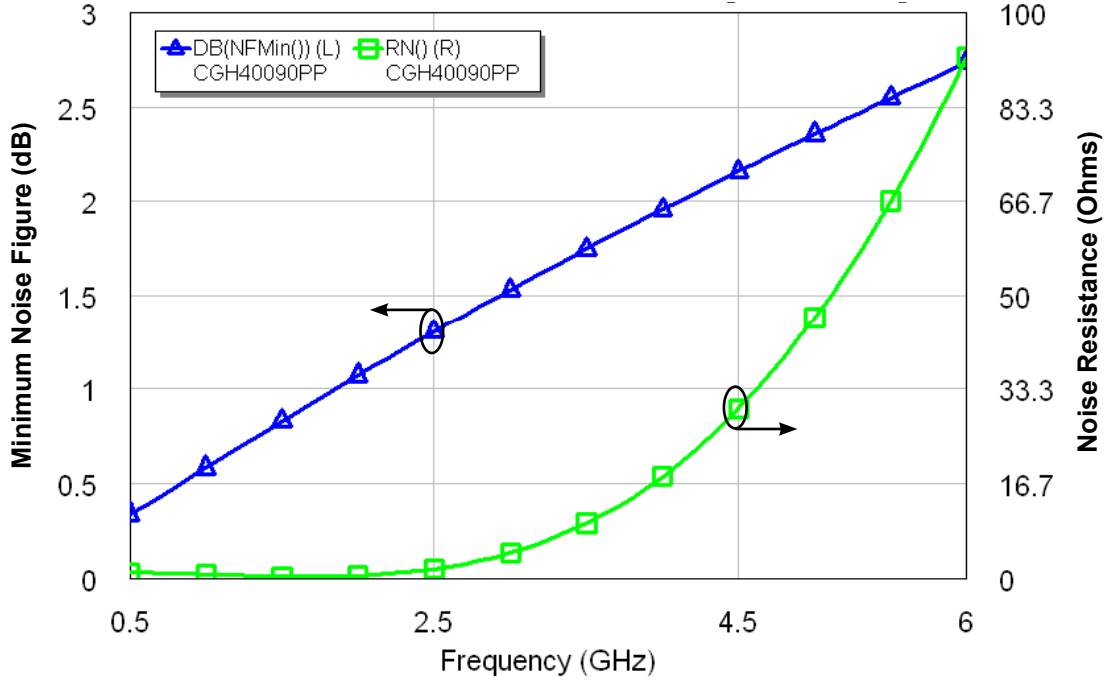

Electrostatic Discharge (ESD) Classifications

Parameter	Symbol	Class	Test Methodology
Human Body Model	HBM	1A > 250 V	JEDEC JESD22 A114-D
Charge Device Model	CDM	1 < 200 V	JEDEC JESD22 C101-C

Simulated Source and Load Impedances

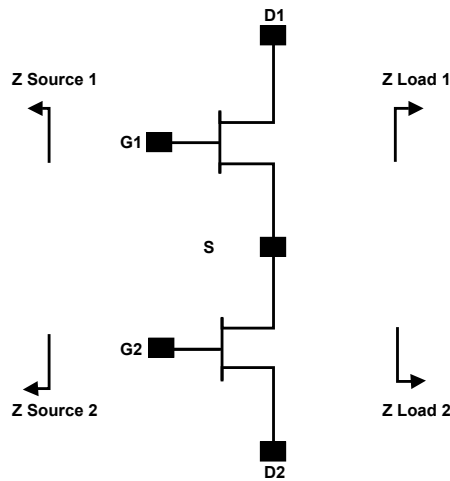

Frequency (MHz)	Z Source (1,2)	Z Load (1,2)
500	$4.28 + j6.47$	$11 + j2.9$
1500	$0.95 - j1.1$	$5.27 + j3$
2500	$0.82 - j5.1$	$3.49 + j0.08$

Note 1. $V_{DD} = 28V$, $I_{DQ} = 1.0A$ in the 440199 package.

Note 2. Optimized for power gain, P_{SAT} and PAE.

Note 3. When using this device at low frequency, series resistors should be used to maintain amplifier stability.

CGH40090PP Power Dissipation De-rating Curve

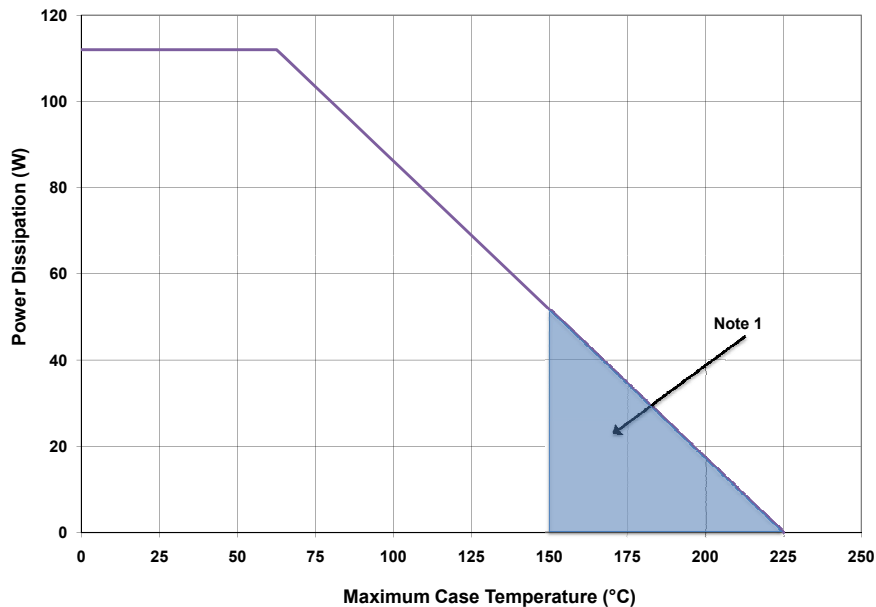

Note 1. Area exceeds Maximum Case Operating Temperature (See Page 2).

CGH40090PP-TB Demonstration Amplifier Circuit Schematic

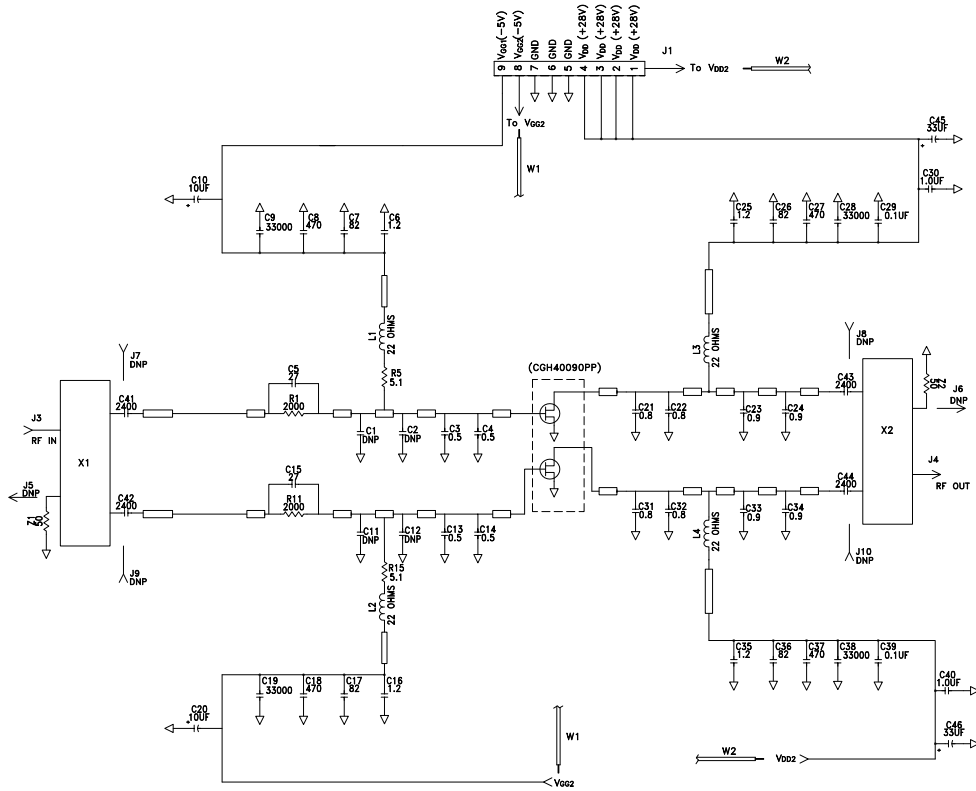

CGH40090PP-TB Demonstration Amplifier Circuit Outline

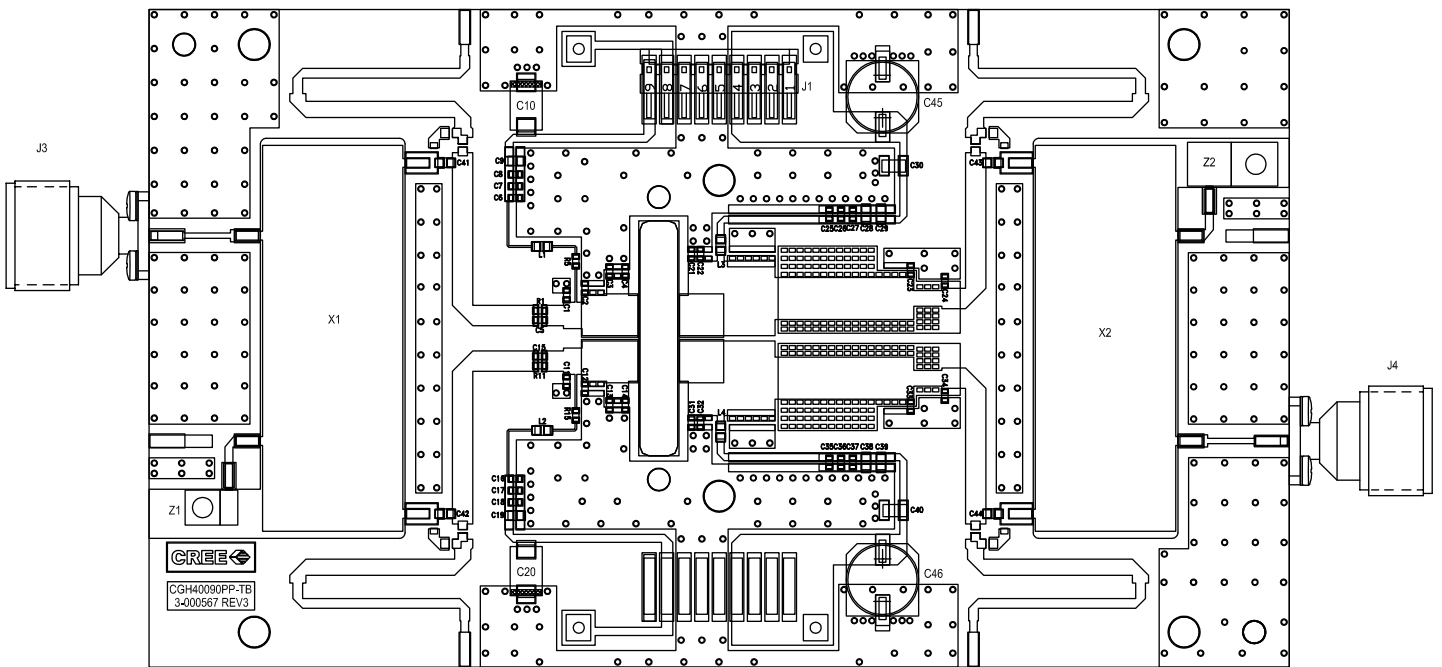

CGH40090PP-TB Demonstration Amplifier Circuit Bill of Materials

Designator	Description	Qty
C3, C4, C13, C14	CAP, 0.5 pF, ± 0.05 pF, 0603, ATC 600S	4
C5,C15	CAP, 27 pF, $\pm 5\%$, 0603, ATC 600S	2
C6,C16,C25,C35	CAP, 1.2 PF ± 0.10 pF, 0603, ATC 600S	4
C7,C17,C26,C36	CAP, 82 pF, $\pm 5\%$, 0603, ATC 600S	4
C8, C18, C27, C37	CAP, CER, 470 pF, 100V, 10%, X7R, 0603	4
C9,C19,C28,C38	CAP, CER, 33000 pF, 100V, X7R, 0805	4
C10,C20	CAP, TANTALUM, 10UF, 25V, 10%, SMD	2
C21, C22, C31, C32	CAP, 0.8 pF, ± 0.1 pF, 0603, ATC 600S	4
C23,C24,C33,C34	CAP, 0.9 pF, ± 0.1 pF, 0603, ATC 600S	4
C29,C39	CAP, CER, 0.1UF, 50V, 10%, X7R, 0805	2
C30,C40	CAP, 1.0 UF, 100V, 10%, X7R, 1210	2
C41,C42,C43,C44	CAP, DC BLOCK, MULTI-LAYER, 0805, 2400 pF	4
C45, C46	CAP, 33 UF, 100V, ELECT, FK, SMD	2
R1,R11	RES, 1/16W, 0603, 1%, 2.00K OHMS	2
R5,R15	RES, 1/16W, 0603, 1%, 5.1 OHMS	2
L1,L2,L3,L4	FERRITE, 22 OHM, 0805, BLM21PG220SN1	4
Z1	50 OHM, TERMINATION, 30 WATT, HALF FLNG	1
Z2	50 OHM, TERMINATION, 50 WATT, FLANGE	1
X1,X2	1.0 - 2.5 GHZ 50 TO 25 OHM COUPLER, IPP 4011	2
J1	CONN, HEADER, RT>PLZ .1CEN LK 9POS	1
J3,J4	CONN,N,FEM,W/.500 SMA FLNG	2
-	PCB, RO4350B, Er = 3.48, h = 20 mil	1
Q1	CGH40090PP	1

CGH40090PP-TB Demonstration Amplifier Circuit

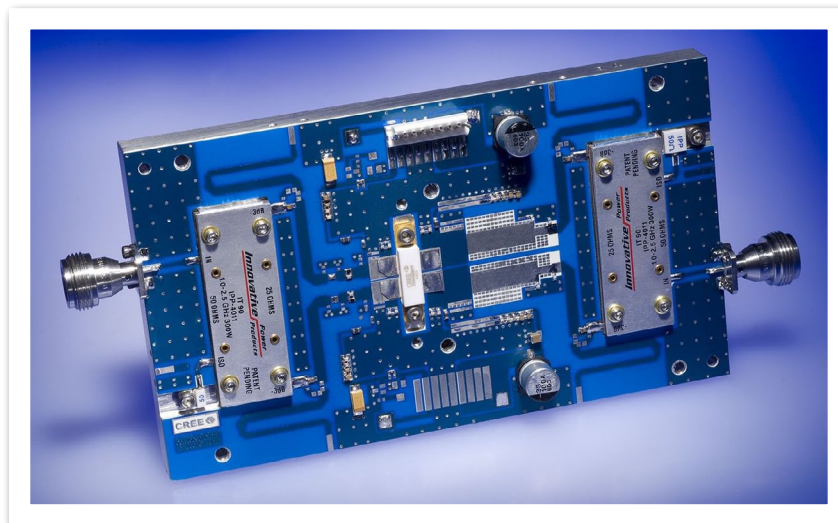



**Typical Package S-Parameters for CGH40090PP, Single Side
(Small Signal, $V_{DS} = 28\text{ V}$, $I_{DQ} = 500\text{ mA}$, angle in degrees)**

Frequency	Mag S11	Ang S11	Mag S21	Ang S21	Mag S12	Ang S12	Mag S22	Ang S22
500 MHz	0.943	-172.11	7.37	81.62	0.011	0.42	0.671	-174.75
600 MHz	0.943	-174.35	6.14	78.14	0.011	-1.24	0.675	-175.11
700 MHz	0.943	-176.10	5.26	74.92	0.011	-2.62	0.679	-175.34
800 MHz	0.943	-177.56	4.60	71.87	0.010	-3.80	0.683	-175.51
900 MHz	0.944	-178.82	4.08	68.95	0.010	-4.81	0.688	-175.64
1.0 GHz	0.944	-179.94	3.67	66.12	0.010	-5.69	0.693	-175.76
1.1 GHz	0.944	179.03	3.33	63.38	0.010	-6.43	0.697	-175.90
1.2 GHz	0.944	178.06	3.05	60.71	0.010	-7.06	0.702	-176.05
1.3 GHz	0.945	177.15	2.82	58.09	0.010	-7.58	0.707	-176.22
1.4 GHz	0.945	176.26	2.62	55.54	0.010	-7.98	0.713	-176.42
1.5 GHz	0.945	175.40	2.44	53.03	0.010	-8.26	0.718	-176.65
1.6 GHz	0.945	174.56	2.29	50.57	0.010	-8.43	0.723	-176.92
1.7 GHz	0.946	173.72	2.16	48.15	0.010	-8.48	0.728	-177.21
1.8 GHz	0.946	172.89	2.04	45.77	0.009	-8.42	0.732	-177.53
1.9 GHz	0.946	172.05	1.94	43.43	0.009	-8.24	0.737	-177.88
2.0 GHz	0.946	171.21	1.85	41.13	0.009	-7.94	0.741	-178.26
2.1 GHz	0.946	170.35	1.77	38.86	0.009	-7.53	0.746	-178.67
2.2 GHz	0.945	169.49	1.70	36.61	0.009	-7.02	0.750	-179.11
2.3 GHz	0.945	168.60	1.63	34.39	0.009	-6.39	0.753	-179.57
2.4 GHz	0.945	167.70	1.58	32.19	0.009	-5.67	0.757	179.95
2.5 GHz	0.945	166.78	1.52	30.01	0.009	-4.86	0.760	179.44
2.6 GHz	0.944	165.83	1.48	27.85	0.009	-3.97	0.763	178.90
2.7 GHz	0.943	164.85	1.44	25.69	0.009	-3.00	0.766	178.34
2.8 GHz	0.943	163.83	1.40	23.55	0.009	-1.98	0.768	177.76
2.9 GHz	0.942	162.79	1.37	21.41	0.009	-0.93	0.770	177.16
3.0 GHz	0.941	161.70	1.35	19.26	0.009	0.15	0.772	176.53
3.2 GHz	0.938	159.38	1.31	14.96	0.010	2.31	0.774	175.21
3.4 GHz	0.935	156.84	1.28	10.59	0.010	4.31	0.775	173.80
3.6 GHz	0.931	154.04	1.26	6.10	0.011	6.02	0.774	172.28
3.8 GHz	0.926	150.90	1.26	1.46	0.012	7.28	0.772	170.66
4.0 GHz	0.920	147.36	1.28	-3.41	0.013	7.95	0.768	168.91
4.2 GHz	0.912	143.31	1.30	-8.59	0.015	7.92	0.762	167.02
4.4 GHz	0.902	138.62	1.35	-14.16	0.017	7.08	0.754	164.97
4.6 GHz	0.890	133.12	1.40	-20.26	0.019	5.31	0.744	162.75
4.8 GHz	0.874	126.58	1.48	-27.01	0.022	2.49	0.731	160.30
5.0 GHz	0.854	118.69	1.58	-34.60	0.026	-1.53	0.714	157.61
5.2 GHz	0.829	109.02	1.70	-43.26	0.030	-6.95	0.695	154.59
5.4 GHz	0.799	97.04	1.85	-53.22	0.035	-13.99	0.672	151.16
5.6 GHz	0.765	82.06	2.01	-64.77	0.041	-22.88	0.645	147.15
5.8 GHz	0.730	63.42	2.18	-78.13	0.048	-33.82	0.613	142.23
6.0 GHz	0.704	40.85	2.32	-93.40	0.055	-46.90	0.575	135.85

Download this s-parameter file in ".s2p" format at http://www.cree.com/products/wireless_s-parameters.asp



**Typical Package S-Parameters for CGH40090PP, Single Side
(Small Signal, $V_{DS} = 28\text{ V}$, $I_{DQ} = 1000\text{ mA}$, angle in degrees)**

Frequency	Mag S11	Ang S11	Mag S21	Ang S21	Mag S12	Ang S12	Mag S22	Ang S22
500 MHz	0.952	-173.06	7.25	82.49	0.009	3.57	0.707	-176.99
600 MHz	0.952	-175.20	6.05	79.29	0.009	2.66	0.709	-177.41
700 MHz	0.952	-176.89	5.19	76.33	0.009	2.01	0.711	-177.72
800 MHz	0.952	-178.31	4.55	73.53	0.009	1.53	0.713	-177.97
900 MHz	0.952	-179.54	4.05	70.83	0.009	1.20	0.716	-178.19
1.0 GHz	0.952	179.35	3.65	68.21	0.009	0.99	0.718	-178.39
1.1 GHz	0.952	178.33	3.32	65.65	0.008	0.88	0.721	-178.59
1.2 GHz	0.952	177.37	3.05	63.15	0.008	0.87	0.724	-178.80
1.3 GHz	0.952	176.46	2.82	60.70	0.008	0.95	0.727	-179.02
1.4 GHz	0.952	175.58	2.63	58.28	0.008	1.11	0.729	-179.25
1.5 GHz	0.952	174.72	2.46	55.90	0.008	1.37	0.732	-179.50
1.6 GHz	0.951	173.87	2.32	53.56	0.008	1.70	0.735	-179.77
1.7 GHz	0.951	173.03	2.19	51.24	0.008	2.12	0.738	179.94
1.8 GHz	0.951	172.19	2.08	48.95	0.008	2.61	0.741	179.63
1.9 GHz	0.951	171.35	1.98	46.68	0.008	3.17	0.743	179.30
2.0 GHz	0.950	170.50	1.89	44.44	0.008	3.80	0.746	178.95
2.1 GHz	0.950	169.64	1.82	42.22	0.009	4.48	0.748	178.57
2.2 GHz	0.950	168.77	1.75	40.01	0.009	5.21	0.750	178.17
2.3 GHz	0.949	167.89	1.69	37.82	0.009	5.99	0.752	177.75
2.4 GHz	0.948	166.98	1.63	35.63	0.009	6.79	0.754	177.31
2.5 GHz	0.948	166.05	1.59	33.46	0.009	7.62	0.756	176.85
2.6 GHz	0.947	165.09	1.54	31.29	0.009	8.45	0.757	176.36
2.7 GHz	0.946	164.10	1.51	29.13	0.009	9.28	0.758	175.85
2.8 GHz	0.945	163.08	1.47	26.96	0.009	10.09	0.759	175.32
2.9 GHz	0.944	162.02	1.44	24.80	0.010	10.87	0.760	174.77
3.0 GHz	0.943	160.92	1.42	22.62	0.010	11.60	0.760	174.19
3.2 GHz	0.940	158.58	1.38	18.22	0.011	12.89	0.760	172.97
3.4 GHz	0.936	156.01	1.36	13.73	0.011	13.85	0.759	171.64
3.6 GHz	0.931	153.17	1.35	9.11	0.013	14.40	0.756	170.22
3.8 GHz	0.926	149.99	1.36	4.29	0.014	14.44	0.752	168.68
4.0 GHz	0.919	146.39	1.37	-0.77	0.015	13.91	0.745	167.02
4.2 GHz	0.910	142.27	1.41	-6.16	0.017	12.71	0.737	165.22
4.4 GHz	0.899	137.51	1.46	-11.97	0.019	10.77	0.727	163.26
4.6 GHz	0.885	131.91	1.52	-18.32	0.022	7.99	0.714	161.14
4.8 GHz	0.868	125.25	1.61	-25.36	0.025	4.22	0.698	158.82
5.0 GHz	0.846	117.21	1.72	-33.26	0.029	-0.67	0.679	156.28
5.2 GHz	0.820	107.37	1.85	-42.24	0.034	-6.89	0.656	153.46
5.4 GHz	0.788	95.18	2.00	-52.53	0.040	-14.64	0.630	150.27
5.6 GHz	0.752	79.98	2.17	-64.39	0.046	-24.17	0.601	146.53
5.8 GHz	0.717	61.12	2.33	-78.01	0.053	-35.65	0.567	141.88
6.0 GHz	0.692	38.42	2.48	-93.47	0.060	-49.14	0.527	135.72

Download this s-parameter file in ".s2p" format at http://www.cree.com/products/wireless_s-parameters.asp

Product Dimensions CGH40090PP (Package Type – 440199)

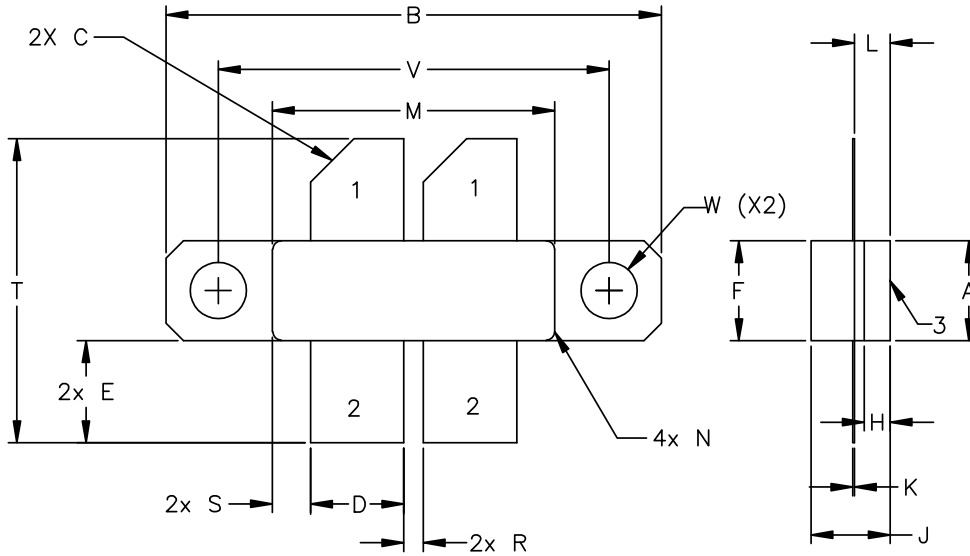

NOTES:

1. DIMENSIONING AND TOLERANCING PER ANSI Y14.5M, 1982.
2. CONTROLLING DIMENSION: INCH.
3. ADHESIVE FROM LID MAY EXTEND A MAXIMUM OF 0.020" BEYOND EDGE OF LID.
4. LID MAY BE MISALIGNED TO THE BODY OF PACKAGE BY A MAXIMUM OF 0.008" IN ANY DIRECTION.

DIM	INCHES		MILLIMETERS	
	MIN	MAX	MIN	MAX
A	0.225	0.235	5.72	5.97
B	1.135	1.145	28.83	29.00
C	0.10	45° REF	2.54	45° REF
D	0.210	0.220	5.33	5.59
E	0.230	0.240	5.84	6.00
F	0.225	0.235	5.71	5.97
H	0.055	0.065	1.40	1.65
J	0.151	0.171	3.84	4.34
K	0.003	0.006	0.08	0.15
L	0.075	0.085	1.91	2.16
M	0.643	0.657	16.30	16.70
N	R.020 REF		R0.51 REF	
R	0.040	0.050	1.00	1.27
S	0.083	0.093	2.10	2.36
T	0.680	0.720	17.30	18.30
V	0.895	0.905	22.70	22.98
W	ø.130		ø 3.30	

STYLE 1:
 PIN 1. GATE
 2. DRAIN
 3. SOURCE



Disclaimer

Specifications are subject to change without notice. Cree, Inc. believes the information contained within this data sheet to be accurate and reliable. However, no responsibility is assumed by Cree for any infringement of patents or other rights of third parties which may result from its use. No license is granted by implication or otherwise under any patent or patent rights of Cree. Cree makes no warranty, representation or guarantee regarding the suitability of its products for any particular purpose. "Typical" parameters are the average values expected by Cree in large quantities and are provided for information purposes only. These values can and do vary in different applications and actual performance can vary over time. All operating parameters should be validated by customer's technical experts for each application. Cree products are not designed, intended or authorized for use as components in applications intended for surgical implant into the body or to support or sustain life, in applications in which the failure of the Cree product could result in personal injury or death or in applications for planning, construction, maintenance or direct operation of a nuclear facility.

For more information, please contact:

Cree, Inc.
4600 Silicon Drive
Durham, North Carolina, USA 27703
www.cree.com/wireless

Sarah Miller
Marketing & Export
Cree, RF Components
1.919.407.5302

Ryan Baker
Marketing
Cree, RF Components
1.919.407.7816

Tom Dekker
Sales Director
Cree, RF Components
1.919.407.5639



Стандарт Электрон Связь

Мы молодая и активно развивающаяся компания в области поставок электронных компонентов. Мы поставляем электронные компоненты отечественного и импортного производства напрямую от производителей и с крупнейших складов мира.

Благодаря сотрудничеству с мировыми поставщиками мы осуществляем комплексные и плановые поставки широчайшего спектра электронных компонентов.

Собственная эффективная логистика и склад в обеспечивает надежную поставку продукции в точно указанные сроки по всей России.

Мы осуществляем техническую поддержку нашим клиентам и предпродажную проверку качества продукции. На все поставляемые продукты мы предоставляем гарантию .

Осуществляем поставки продукции под контролем ВП МО РФ на предприятия военно-промышленного комплекса России , а также работаем в рамках 275 ФЗ с открытием отдельных счетов в уполномоченном банке. Система менеджмента качества компании соответствует требованиям ГОСТ ISO 9001.

Минимальные сроки поставки, гибкие цены, неограниченный ассортимент и индивидуальный подход к клиентам являются основой для выстраивания долгосрочного и эффективного сотрудничества с предприятиями радиоэлектронной промышленности, предприятиями ВПК и научно-исследовательскими институтами России.

С нами вы становитесь еще успешнее!

Наши контакты:

Телефон: +7 812 627 14 35

Электронная почта: sales@st-electron.ru

Адрес: 198099, Санкт-Петербург,
Промышленная ул, дом № 19, литера Н,
помещение 100-Н Офис 331