

General-purpose, low voltage rail-to-rail output operational amplifiers

Datasheet - production data



Applications

- Battery-powered applications
- Portable devices
- Signal conditioning
- Active filtering
- Medical instrumentation

Description

The LMX3xx series is a set of single, dual, and quad low-voltage, general-purpose, operational amplifiers. These devices can operate from 2.3 V to 5.5 V with a typical current consumption of 120 μ A per channel. The LMX3xx series offers a rail-to-rail output and an input common-mode voltage that includes ground.

The LMX3xx series also exhibits a 1.3 MHz gain bandwidth and they can drive capacitive loads. The devices are stable while operating at unity gain. They are offered with industry standard pinouts in tiny packages.

Features

- Low power consumption: 120 μ A at 2.7 V
- Low supply voltage: 2.3 V - 5.5 V
- Rail-to-rail output swing
- Gain bandwidth product: 1.3 MHz
- Extended temperature range: -40 °C to 125 °C
- No crossover distortion
- No phase reversal
- Tiny packages

Related products

- See the TSV85x series for higher accuracy, stand-by options, and smaller packages

Table 1. Device summary

| Reference | Single | Dual | Quad |
|-----------|--------|--------|--------|
| LMX3xx | LMX321 | LMX358 | LMX324 |

Contents

| | | |
|----------|--|-----------|
| 1 | Package pin connections | 3 |
| 2 | Absolute maximum ratings and operating conditions | 4 |
| 3 | Electrical characteristics | 5 |
| 4 | Application information | 13 |
| 4.1 | Operating voltages | 13 |
| 4.2 | Input common-mode range | 13 |
| 4.3 | Rail-to-rail output | 13 |
| 4.4 | Input offset voltage drift over temperature | 13 |
| 4.5 | PCB layouts | 13 |
| 4.6 | Macromodel | 13 |
| 5 | Package information | 14 |
| 5.1 | SC70-5 (or SOT323-5) package information | 15 |
| 5.2 | SOT23-5 package information | 16 |
| 5.3 | DFN8 2x2 package information | 17 |
| 5.4 | MiniSO8 package information | 19 |
| 5.5 | SO8 package information | 20 |
| 5.6 | TSSOP14 package information | 21 |
| 5.7 | SO14 package information | 22 |
| 6 | Ordering information | 23 |
| 7 | Revision history | 24 |

1 Package pin connections

Figure 1. Pin connections for each package (top view)



1. The exposed pad of the DFN8 2x2 can be connected to VCC- or left floating.

2 Absolute maximum ratings and operating conditions

Table 2. Absolute maximum ratings (AMR)

| Symbol | Parameter | Value | Unit |
|------------|--|------------------------------------|------|
| V_{CC} | Supply voltage ⁽¹⁾ | 6 | V |
| V_{id} | Differential input voltage ⁽²⁾ | $\pm V_{CC}$ | |
| V_{in} | Input pins (IN+ and IN- pins) voltage ⁽³⁾ | $V_{CC-} - 0.3$ to $V_{CC+} + 0.3$ | |
| I_{in} | Input current ⁽⁴⁾ | 10 | mA |
| T_{stg} | Storage temperature | -65 to +150 | °C |
| R_{thja} | Thermal resistance junction to ambient ⁽⁵⁾⁽⁶⁾ | | °C/W |
| | SC70-5 | 205 | |
| | SOT23-5 | 250 | |
| | DFN8 2x2 | 57 | |
| | MiniSO8 | 190 | |
| | SO8 | 125 | |
| | TSSOP14 | 100 | |
| SO14 | 105 | | |
| T_j | Maximum junction temperature | 150 | °C |
| ESD | HBM: human body model ⁽⁷⁾ | 4000 | V |
| | MM: machine model ⁽⁸⁾ | 250 | |
| | CDM: charged device model ⁽⁹⁾ | 1300 | |
| | Latch-up immunity | 200 | mA |

1. All voltage values, except differential voltage, are with respect to network ground terminal.
2. Differential voltages are the non-inverting input terminal with respect to the inverting input terminal.
3. $V_{CC-} - V_{in}$ must not exceed 6 V, V_{in} must not exceed 6 V.
4. Input current must be limited by a resistor in series with the inputs.
5. Short-circuits can cause excessive heating and destructive dissipation.
6. R_{th} are typical values.
7. Human body model: 100 pF discharged through a 1.5 kΩ resistor between two pins of the device, done for all couples of pin combinations with other pins floating.
8. Machine model: a 200 pF cap is charged to the specified voltage, then discharged directly between two pins of the device with no external series resistor (internal resistor < 5 Ω), done for all couples of pin combinations with other pins floating.
9. Charged device model: all pins plus package are charged together to the specified voltage and then discharged directly to the ground.

Table 3. Operating conditions

| Symbol | Parameter | Value | Unit |
|------------|--------------------------------------|----------------------------------|------|
| V_{CC} | Supply voltage | 2.3 to 5.5 | V |
| V_{icm} | Common mode input voltage range | $V_{CC-} - 0.2$ to $V_{CC+} - 1$ | |
| T_{oper} | Operating free air temperature range | -40 to +125 | °C |

3 Electrical characteristics

Table 4. Electrical characteristics at $V_{CC+} = 2.7\text{ V}$ with $V_{CC-} = 0\text{ V}$, $V_{icm} = V_{CC}/2$, $T_{amb} = 25^\circ\text{ C}$, and R_L connected to $V_{CC}/2$ (unless otherwise specified)

| Symbol | Parameter | Conditions | Min. | Typ. | Max. | Unit |
|--------------------------|---|--|------|------|------|-------------------------------|
| DC performance | | | | | | |
| V_{io} | Input offset voltage | | | | 4 | mV |
| | | $-40^\circ\text{ C} < T < 125^\circ\text{ C}$ | | | 6 | |
| $\Delta V_{io}/\Delta T$ | Input offset voltage drift ⁽¹⁾ | $-40^\circ\text{ C} < T < 125^\circ\text{ C}$ | | 1 | | $\mu\text{V}/^\circ\text{ C}$ |
| I_{io} | Input offset current | $V_{out} = V_{CC}/2$ | | 0.5 | 30 | nA |
| | | $-40^\circ\text{ C} < T < 125^\circ\text{ C}$ | | | 50 | |
| I_{ib} | Input bias current | $V_{out} = V_{CC}/2$ | | 27 | 60 | nA |
| | | $-40^\circ\text{ C} < T < 125^\circ\text{ C}$ | | | 110 | |
| CMR | Common mode rejection ratio $20 \log (\Delta V_{icm}/\Delta V_{io})$ | $V_{ic} = 0\text{ V to } V_{CC}-1\text{ V},$ $V_{out} = V_{CC}/2$ | 70 | 75 | | dB |
| | | $-40^\circ\text{ C} < T < 125^\circ\text{ C}$ | 68 | | | |
| A_{vd} | Large signal voltage gain | $R_L = 10\text{ k}\Omega,$ $V_{out} = 0.5\text{ V to } (V_{CC}-0.5\text{ V})$ | 100 | 110 | | dB |
| | | $-40^\circ\text{ C} < T < 125^\circ\text{ C}$ | 90 | | | |
| | | $R_L = 2\text{ k}\Omega,$ $V_{out} = 0.5\text{ V to } (V_{CC}-0.5\text{ V})$ | 90 | 100 | | |
| | | $-40^\circ\text{ C} < T < 125^\circ\text{ C}$ | 80 | | | |
| $V_{CC}-V_{OH}$ | High level output voltage | $R_L = 10\text{ k}\Omega,$ | | 10 | 100 | mV |
| | | $-40^\circ\text{ C} < T < 125^\circ\text{ C}$ | | | 200 | |
| | | $R_L = 2\text{ k}\Omega$ | | 40 | 300 | |
| | | $-40^\circ\text{ C} < T < 125^\circ\text{ C}$ | | | 400 | |
| V_{OL} | Low level output voltage | $R_L = 10\text{ k}\Omega,$ | | 65 | 180 | mV |
| | | $-40^\circ\text{ C} < T < 125^\circ\text{ C}$ | | | 280 | |
| | | $R_L = 2\text{ k}\Omega,$ | | 120 | 300 | |
| | | $-40^\circ\text{ C} < T < 125^\circ\text{ C}$ | | | 400 | |
| I_{out} | I_{sink} | $V_{out} = V_{CC}, V_{id} = -1\text{ V}$ | 15 | 26 | | mA |
| | | $-40^\circ\text{ C} < T < 125^\circ\text{ C}$ | 15 | | | |
| | I_{source} | $V_{out} = 0\text{ V}, V_{id} = 1\text{ V}$ | 15 | 21 | | |
| | | $-40^\circ\text{ C} < T < 125^\circ\text{ C}$ | 12 | | | |
| I_{CC} | Supply current (per channel) | No load, $V_{out} = V_{CC}/2$ | | 120 | 180 | μA |
| | | $-40^\circ\text{ C} < T < 125^\circ\text{ C}$ | | | 180 | |

Table 4. Electrical characteristics at $V_{CC+} = 2.7\text{ V}$ with $V_{CC-} = 0\text{ V}$, $V_{icm} = V_{CC}/2$, $T_{amb} = 25^\circ\text{ C}$, and R_L connected to $V_{CC}/2$ (unless otherwise specified) (continued)

| Symbol | Parameter | Conditions | Min. | Typ. | Max. | Unit |
|-----------------------|-----------------------------------|---|------|----------|------|--------------------------------------|
| AC performance | | | | | | |
| GBP | Gain bandwidth product | $R_L > 1\text{ M}\Omega$, $C_L = 200\text{ pF}$ | | 1.3 | | MHz |
| F_u | Unity gain frequency | | | 1 | | |
| Φ_m | Phase margin | | | 60 | | degrees |
| G_m | Gain margin | | | 10 | | dB |
| SR | Slew rate | $R_L > 1\text{ M}\Omega$, $C_L = 200\text{ pF}$ $V_{out} = 0.5\text{ V}$ to $V_{CC} - 0.5\text{ V}$ | | 0.6 | | V/ μs |
| e_n | Equivalent input noise voltage | $f = 1\text{ kHz}$ $f = 10\text{ kHz}$ | | 31 20 | | $\frac{\text{nV}}{\sqrt{\text{Hz}}}$ |
| i_n | Equivalent input noise current | $f = 1\text{ kHz}$ | | 0.30 | | $\frac{\text{pA}}{\sqrt{\text{Hz}}}$ |
| THD+N | Total harmonic distortion + noise | $f_{in} = 1\text{ kHz}$, $A_{CL} = 1$, $R_L = 10\text{ k}\Omega$, $V_{ICM} = V_{CC}/2$, $BW = 22\text{ kHz}$, $V_{out} = 1\text{ V}_{pp}$ | | 0.002 | | % |

Table 5. Electrical characteristics at $V_{CC+} = 5\text{ V}$ with $V_{CC-} = 0\text{ V}$, $V_{icm} = V_{CC}/2$, $T_{amb} = 25^\circ\text{ C}$, and R_L connected to $V_{CC}/2$ (unless otherwise specified)

| Symbol | Parameter | Conditions | Min. | Typ. | Max. | Unit |
|--------------------------|---|--|------|------|------|-------------------------------|
| DC performance | | | | | | |
| V_{io} | Input offset voltage | | | | 4 | mV |
| | | $-40^\circ\text{ C} < T < 125^\circ\text{ C}$ | | | 6 | |
| $\Delta V_{io}/\Delta T$ | Input offset voltage drift ⁽¹⁾ | $-40^\circ\text{ C} < T < 125^\circ\text{ C}$ | | 1 | | $\mu\text{V}/^\circ\text{ C}$ |
| I_{io} | Input offset current | $V_{out} = V_{CC}/2$ | | 0.5 | 30 | nA |
| | | $-40^\circ\text{ C} < T < 125^\circ\text{ C}$ | | | 50 | |
| I_{ib} | Input bias current | $V_{out} = V_{CC}/2$ | | 27 | 60 | |
| | | $-40^\circ\text{ C} < T < 125^\circ\text{ C}$ | | | 110 | |
| CMR | Common mode rejection ratio $20 \log (\Delta V_{icm}/\Delta V_{io})$ | $V_{ic} = 0\text{ V to } V_{CC}-1\text{ V},$ $V_{out} = V_{CC}/2$ | 72 | 75 | | dB |
| | | $-40^\circ\text{ C} < T < 125^\circ\text{ C}$ | 70 | | | |
| SVR | Supply voltage rejection ratio $20 \log (\Delta V_{CC}/\Delta V_{io})$ | $V_{CC} = 2.5\text{ to }5\text{ V}$ | 72 | 79 | | |
| | | $-40^\circ\text{ C} < T < 125^\circ\text{ C}$ | 70 | | | |
| A_{vd} | Large signal voltage gain | $R_L = 10\text{ k}\Omega,$ $V_{out} = 0.5\text{ V to } (V_{CC} - 0.5\text{ V})$ | 100 | 110 | | |
| | | $-40^\circ\text{ C} < T < 125^\circ\text{ C}$ | 90 | | | |
| | | $R_L = 2\text{ k}\Omega,$ | 90 | 100 | | |
| | | $-40^\circ\text{ C} < T < 125^\circ\text{ C}$ | 80 | | | |
| $V_{CC}-V_{OH}$ | High level output voltage | $R_L = 10\text{ k}\Omega$ | | 10 | 100 | mV |
| | | $-40^\circ\text{ C} < T < 125^\circ\text{ C}$ | | | 200 | |
| | | $R_L = 2\text{ k}\Omega,$ | | 40 | 300 | |
| | | $-40^\circ\text{ C} < T < 125^\circ\text{ C}$ | | | 400 | |
| V_{OL} | Low level output voltage | $R_L = 10\text{ k}\Omega$ | | 65 | 180 | |
| | | $-40^\circ\text{ C} < T < 125^\circ\text{ C}$ | | | 280 | |
| | | $R_L = 2\text{ k}\Omega,$ | | 120 | 300 | |
| | | $-40^\circ\text{ C} < T < 125^\circ\text{ C}$ | | | 400 | |
| I_{out} | I_{sink} | $V_{out} = V_{CC}, V_{id} = -1\text{ V}$ | 35 | 43 | | mA |
| | | $-40^\circ\text{ C} < T < 125^\circ\text{ C}$ | 25 | | | |
| | I_{source} | $V_{out} = 0\text{ V}, V_{id} = 1\text{ V}$ | 60 | 70 | | |
| | | $-40^\circ\text{ C} < T < 125^\circ\text{ C}$ | 50 | | | |
| I_{CC} | Supply current (per channel) | No load, $V_{out} = V_{CC}/2$ | | 130 | 180 | $\mu\text{ A}$ |
| | | $-40^\circ\text{ C} < T < 125^\circ\text{ C}$ | | | 180 | |

Table 5. Electrical characteristics at $V_{CC+} = 5\text{ V}$ with $V_{CC-} = 0\text{ V}$, $V_{icm} = V_{CC}/2$, $T_{amb} = 25^\circ\text{ C}$, and R_L connected to $V_{CC}/2$ (unless otherwise specified) (continued)

| Symbol | Parameter | Conditions | Min. | Typ. | Max. | Unit |
|-----------------------|-----------------------------------|--|------|----------|------|--------------------------------------|
| AC performance | | | | | | |
| GBP | Gain bandwidth product | $R_L > 1\text{ M}\Omega$, $C_L = 200\text{ pF}$ | | 1.3 | | MHz |
| F_u | Unity gain frequency | | | 1 | | |
| Φ_m | Phase margin | | | 60 | | degrees |
| G_m | Gain margin | | | 10 | | dB |
| SR | Slew rate | $R_L > 1\text{ M}\Omega$, $C_L = 200\text{ pF}$ $V_{out} = 0.5\text{ V to } V_{CC} - 0.5\text{ V}$ | | 0.7 | | V/ μs |
| e_n | Equivalent input noise voltage | $f = 1\text{ kHz}$ $f = 10\text{ kHz}$ | | 30 20 | | $\frac{\text{nV}}{\sqrt{\text{Hz}}}$ |
| i_n | Equivalent input noise current | $f = 1\text{ kHz}$ | | 0.30 | | $\frac{\text{pA}}{\sqrt{\text{Hz}}}$ |
| THD+N | Total harmonic distortion + noise | $f_{in} = 1\text{ kHz}$, $A_{CL} = 1$, $R_L = 10\text{ k}\Omega$, $V_{ICM} = V_{CC}/2$, $BW = 22\text{ kHz}$, $V_{out} = 1\text{ Vpp}$ | | 0.002 | | % |

1. See [Section 4.4: Input offset voltage drift over temperature](#).

Figure 2. Supply current vs. supply voltage at $V_{icm} = V_{CC}/2$



Figure 3. V_{io} distribution at $V_{CC} = 5 V$



Figure 4. Input offset voltage vs. input common mode voltage at $V_{CC} = 5 V$



Figure 5. Output current vs. output voltage at $V_{CC} = 2.7 V$



Figure 6. Output current vs. output voltage at $V_{CC} = 5 V$

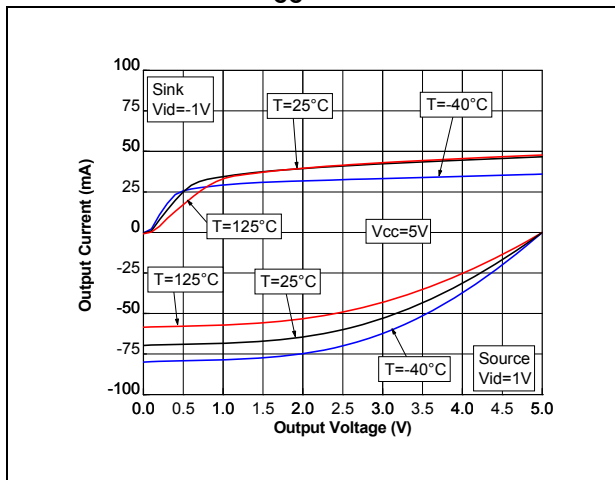

Figure 7. Output current vs. supply voltage at $V_{icm} = V_{CC}/2$

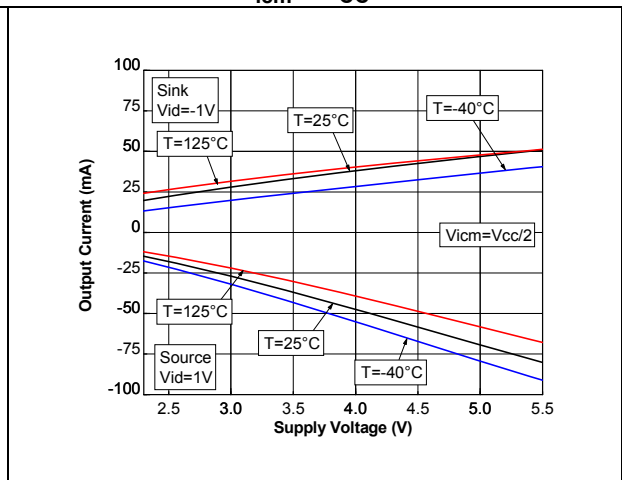

Figure 8. Voltage gain and phase with $C_I = 100\text{ pF}$

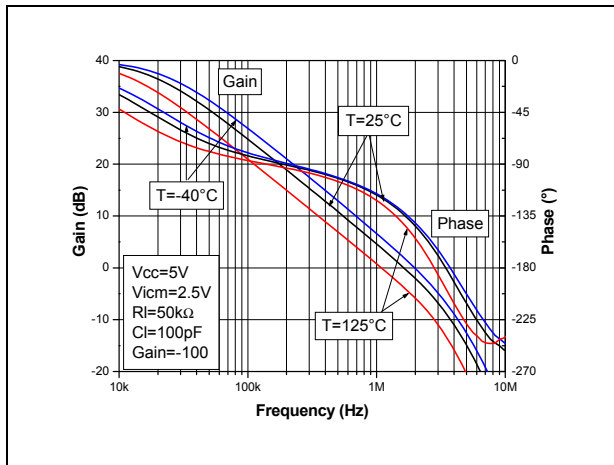

Figure 9. Voltage gain and phase with $C_I = 200\text{ pF}$

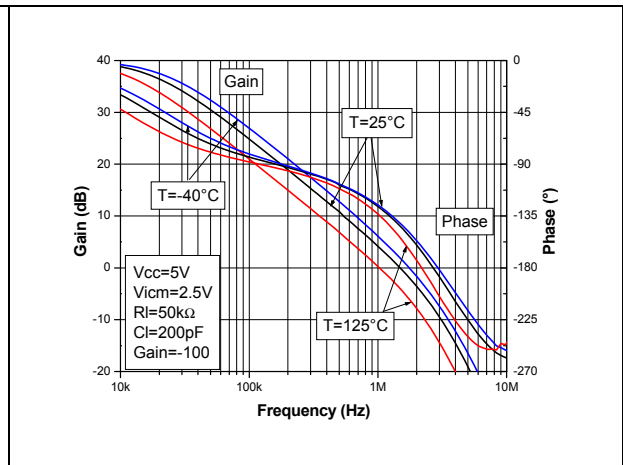

Figure 10. Gain margin vs. load capacitor at $V_{CC} = 5\text{ V}$

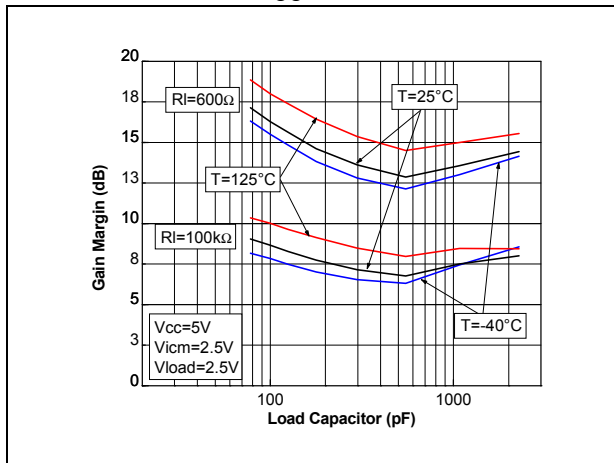

Figure 11. Phase margin vs. load capacitor at $V_{CC} = 5\text{ V}$

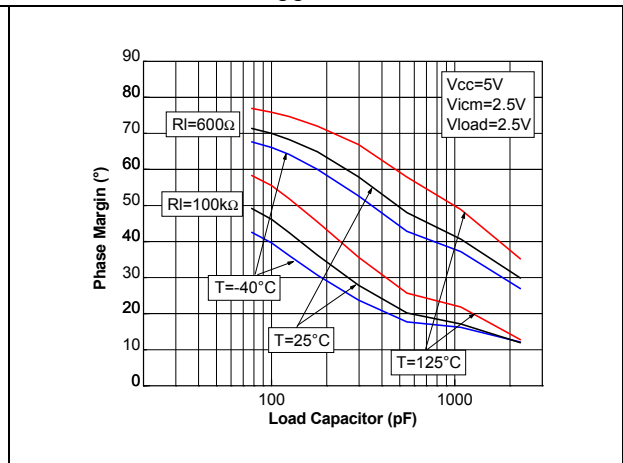

Figure 12. Closed-loop gain in voltage follower configuration for different capacitive loads

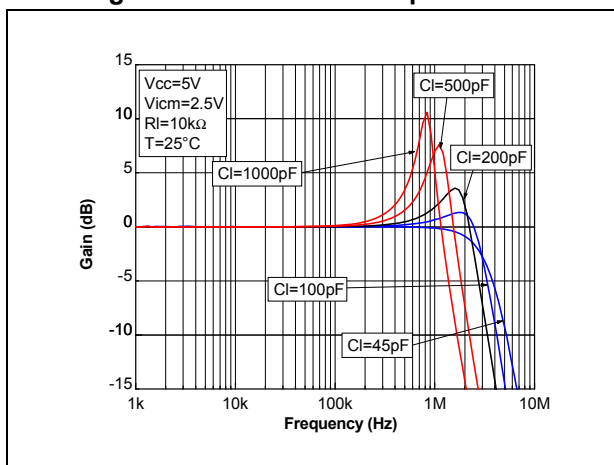

Figure 13. Phase margin vs. output current at $V_{CC} = 5\text{ V}$

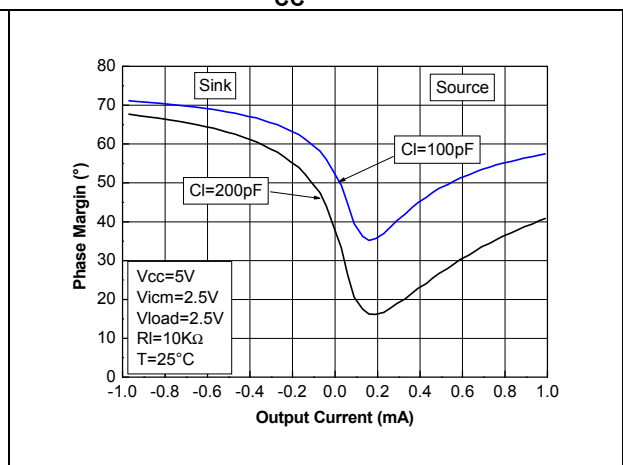

Figure 14. Positive and negative slew rate vs. supply voltage



Figure 15. Positive slew rate at V_{CC} = 5 V with CI = 100 pF



Figure 16. Negative slew rate at V_{CC} = 5 V with CI = 100 pF



Figure 17. Noise vs. frequency



Figure 18. 0.1 Hz to 10 Hz noise at V_{CC} = 5 V

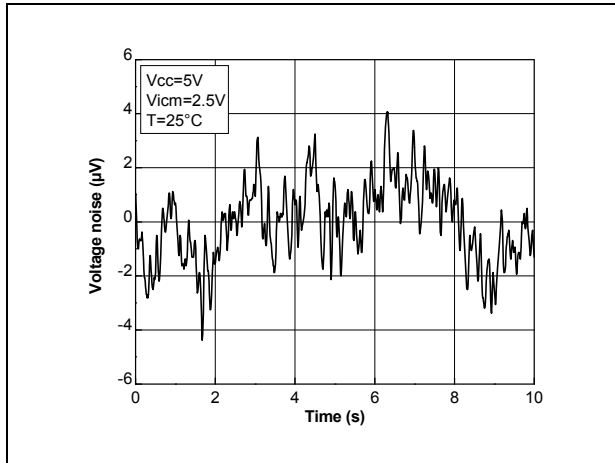

Figure 19. Distortion + noise vs. frequency

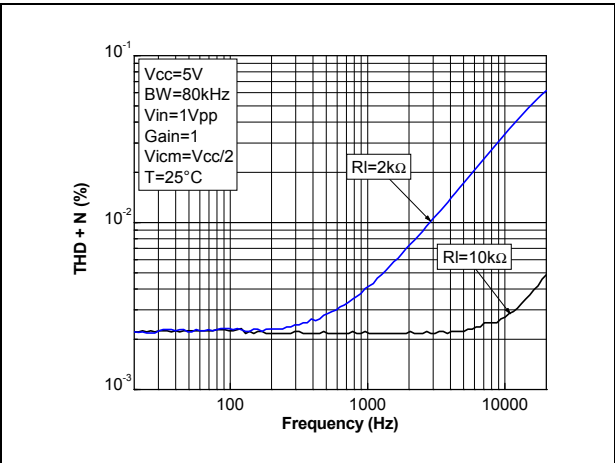

Figure 20. Distortion + noise vs. output voltage



4 Application information

4.1 Operating voltages

The LMX321, LMX358, and LMX324 can operate from 2.3 V to 5.5 V. The devices' parameters are fully specified for 2.7 V and 5 V power supplies. Additionally, the main specifications are guaranteed in extended temperature ranges from -40° C to +125° C.

4.2 Input common-mode range

The LMX321, LMX358, and LMX324 have an input common-mode range that includes ground. The input common-mode range is extended from $V_{CC-} - 0.2$ V to $V_{CC+} - 1$ V, with no output phase reversal.

4.3 Rail-to-rail output

The operational amplifiers' output levels can go close to the rails: to a maximum of 180 mV above and below the rail when connected to a 10 k Ω resistive load to $V_{CC}/2$.

4.4 Input offset voltage drift over temperature

The maximum input voltage drift over the temperature variation is defined in [Equation 1](#).

Equation 1

$$\frac{\Delta V_{io}}{\Delta T} = \max \left| \frac{V_{io}(T) - V_{io}(25^\circ \text{C})}{T - 25^\circ \text{C}} \right|$$

for $T_{\min} < T < T_{\max}$.

4.5 PCB layouts

For correct operation, it is advised to add 10 nF decoupling capacitors as close as possible to the power supply pins.

4.6 Macromodel

Accurate macromodels of the LMX321, LMX358, and LMX324 are available on STMicroelectronics' web site at www.st.com. These models are a trade-off between accuracy and complexity (that is, time simulation) of the LMX321, LMX358, and LMX324 operational amplifiers. They emulate the nominal performances of a typical device within the specified operating conditions mentioned in the datasheet. They also help to validate a design approach and to select the right operational amplifier, *but they do not replace on-board measurements*.

5 Package information

In order to meet environmental requirements, ST offers these devices in different grades of ECOPACK[®] packages, depending on their level of environmental compliance. ECOPACK[®] specifications, grade definitions and product status are available at: www.st.com. ECOPACK[®] is an ST trademark.

5.1 SC70-5 (or SOT323-5) package information

Figure 21. SC70-5 (or SOT323-5) package mechanical drawing

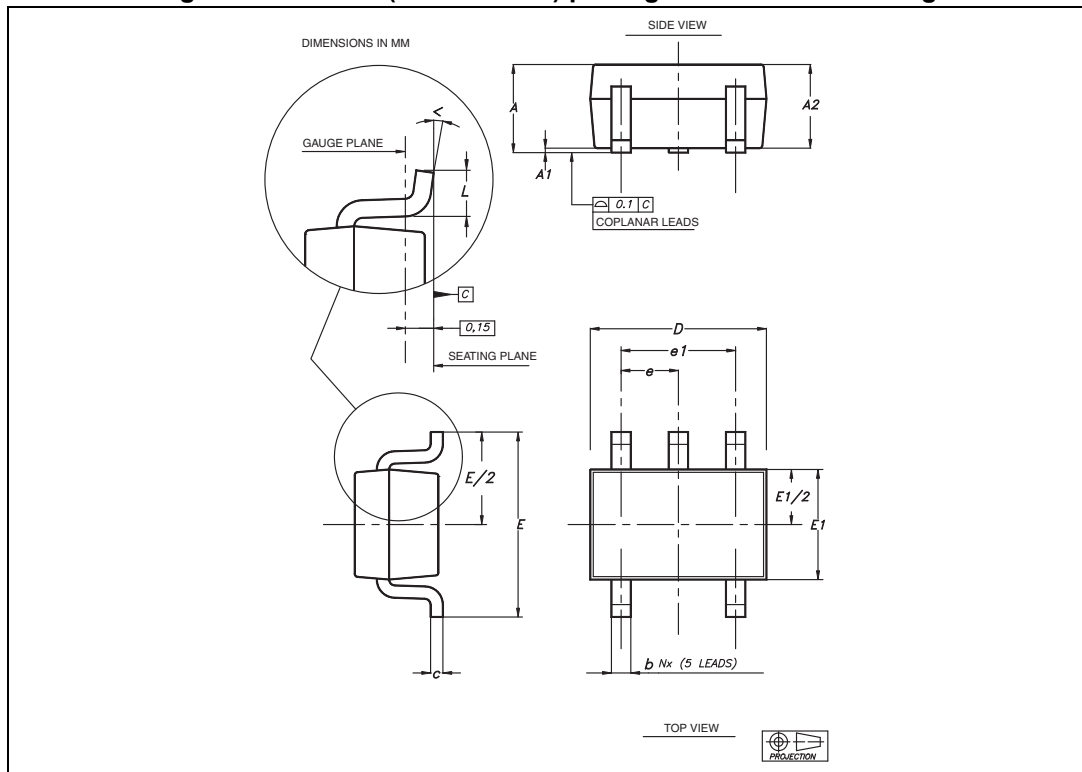

Table 6. SC70-5 (or SOT323-5) package mechanical data

| Ref | Dimensions | | | | | |
|-----|-------------|------|------|--------|-------|-------|
| | Millimeters | | | Inches | | |
| | Min | Typ | Max | Min | Typ | Max |
| A | 0.80 | | 1.10 | 0.032 | | 0.043 |
| A1 | | | 0.10 | | | 0.004 |
| A2 | 0.80 | 0.90 | 1.00 | 0.032 | 0.035 | 0.039 |
| b | 0.15 | | 0.30 | 0.006 | | 0.012 |
| c | 0.10 | | 0.22 | 0.004 | | 0.009 |
| D | 1.80 | 2.00 | 2.20 | 0.071 | 0.079 | 0.087 |
| E | 1.80 | 2.10 | 2.40 | 0.071 | 0.083 | 0.094 |
| E1 | 1.15 | 1.25 | 1.35 | 0.045 | 0.049 | 0.053 |
| e | | 0.65 | | | 0.025 | |
| e1 | | 1.30 | | | 0.051 | |
| L | 0.26 | 0.36 | 0.46 | 0.010 | 0.014 | 0.018 |
| < | 0° | | 8° | 0° | | 8° |

5.2 SOT23-5 package information

Figure 22. SOT23-5 package mechanical drawing



Table 7. SOT23-5 package mechanical data

| Ref. | Dimensions | | | | | |
|------|-------------|------|------|--------|-------|-------|
| | Millimeters | | | Inches | | |
| | Min. | Typ. | Max. | Min. | Typ. | Max. |
| A | 0.90 | 1.20 | 1.45 | 0.035 | 0.047 | 0.057 |
| A1 | | | 0.15 | | | 0.006 |
| A2 | 0.90 | 1.05 | 1.30 | 0.035 | 0.041 | 0.051 |
| B | 0.35 | 0.40 | 0.50 | 0.013 | 0.015 | 0.019 |
| C | 0.09 | 0.15 | 0.20 | 0.003 | 0.006 | 0.008 |
| D | 2.80 | 2.90 | 3.00 | 0.110 | 0.114 | 0.118 |
| D1 | | 1.90 | | | 0.075 | |
| e | | 0.95 | | | 0.037 | |
| E | 2.60 | 2.80 | 3.00 | 0.102 | 0.110 | 0.118 |
| F | 1.50 | 1.60 | 1.75 | 0.059 | 0.063 | 0.069 |
| L | 0.10 | 0.35 | 0.60 | 0.004 | 0.013 | 0.023 |
| K | 0 ° | | 10 ° | 0 ° | | 10 ° |

5.3 DFN8 2x2 package information

Figure 23. DFN8 2x2 package mechanical drawing

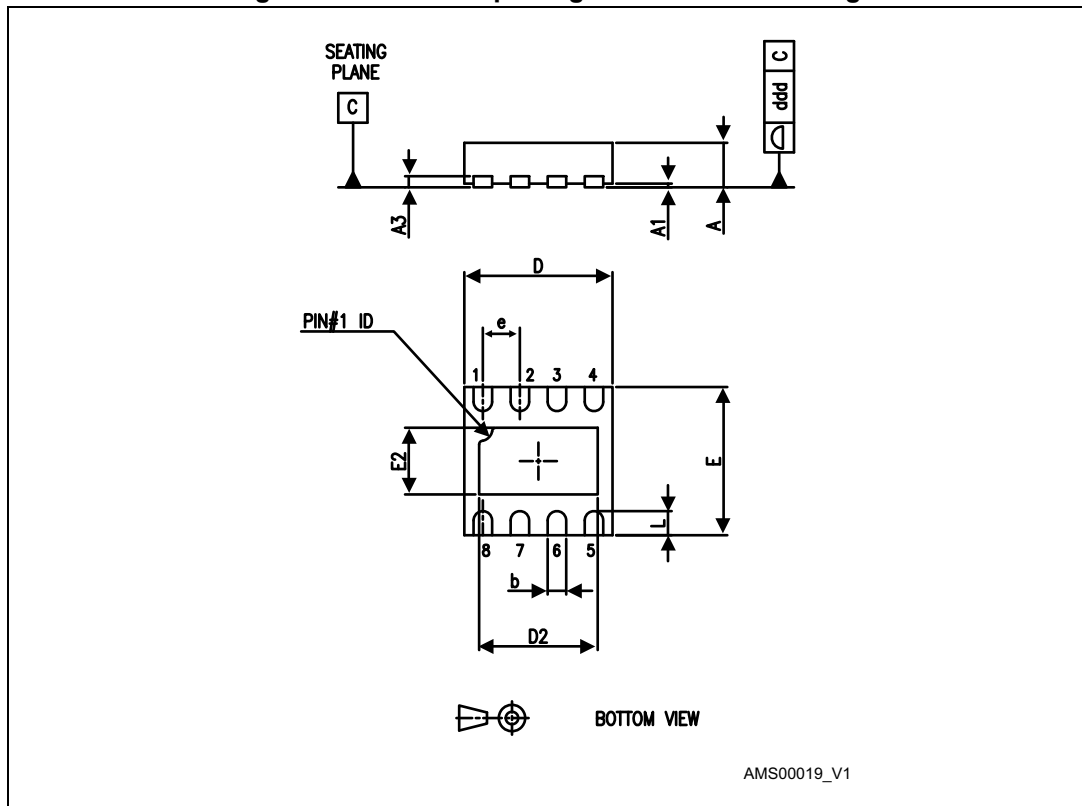

Figure 24. DFN8 2x2x0.6 mm package mechanical data (pitch 0.5 mm)

| Ref. | Dimensions | | | | | |
|------|-------------|------|-------|--------|-------|-------|
| | Millimeters | | | Inches | | |
| | Min. | Typ. | Max. | Min. | Typ. | Max. |
| A | 0.51 | 0.55 | 0.60 | 0.020 | 0.022 | 0.024 |
| A1 | | | 0.05 | | | 0.002 |
| A3 | | 0.15 | | | 0.006 | |
| b | 0.18 | 0.25 | 0.30 | 0.007 | 0.010 | 0.012 |
| D | 1.85 | 2.00 | 2.15 | 0.073 | 0.079 | 0.085 |
| D2 | 1.45 | 1.60 | 1.70 | 0.057 | 0.063 | 0.067 |
| E | 1.85 | 2.00 | 2.15 | 0.073 | 0.079 | 0.085 |
| E2 | 0.75 | 0.90 | 1.00 | 0.030 | 0.035 | 0.039 |
| e | | 0.50 | | | 0.020 | |
| L | | | 0.425 | | | 0.017 |
| ddd | | | 0.08 | | | 0.003 |

Figure 25. DFN8 2x2 footprint recommendation



5.4 MiniSO8 package information

Figure 26. MiniSO8 package mechanical drawing

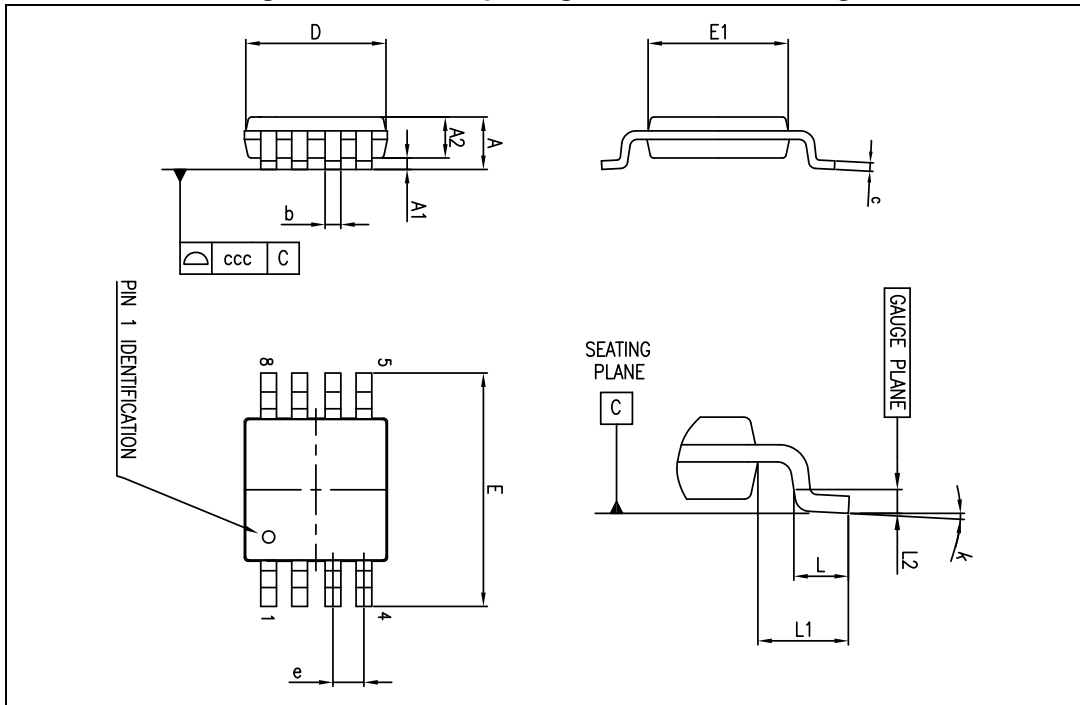

Table 8. MiniSO8 package mechanical data

| Ref. | Dimensions | | | | | |
|------|-------------|------|------|--------|-------|-------|
| | Millimeters | | | Inches | | |
| | Min. | Typ. | Max. | Min. | Typ. | Max. |
| A | | | 1.1 | | | 0.043 |
| A1 | 0 | | 0.15 | 0 | | 0.006 |
| A2 | 0.75 | 0.85 | 0.95 | 0.030 | 0.033 | 0.037 |
| b | 0.22 | | 0.40 | 0.009 | | 0.016 |
| c | 0.08 | | 0.23 | 0.003 | | 0.009 |
| D | 2.80 | 3.00 | 3.20 | 0.11 | 0.118 | 0.126 |
| E | 4.65 | 4.90 | 5.15 | 0.183 | 0.193 | 0.203 |
| E1 | 2.80 | 3.00 | 3.10 | 0.11 | 0.118 | 0.122 |
| e | | 0.65 | | | 0.026 | |
| L | 0.40 | 0.60 | 0.80 | 0.016 | 0.024 | 0.031 |
| L1 | | 0.95 | | | 0.037 | |
| L2 | | 0.25 | | | 0.010 | |
| k | 0° | | 8° | 0° | | 8° |
| ccc | | | 0.10 | | | 0.004 |

5.5 SO8 package information

Figure 27. SO8 package mechanical drawing



Table 9. SO8 package mechanical data

| Ref. | Dimensions | | | | | |
|------|-------------|------|------|--------|-------|-------|
| | Millimeters | | | Inches | | |
| | Min. | Typ. | Max. | Min. | Typ. | Max. |
| A | | | 1.75 | | | 0.069 |
| A1 | 0.10 | | 0.25 | 0.004 | | 0.010 |
| A2 | 1.25 | | | 0.049 | | |
| b | 0.28 | | 0.48 | 0.011 | | 0.019 |
| c | 0.17 | | 0.23 | 0.007 | | 0.010 |
| D | 4.80 | 4.90 | 5.00 | 0.189 | 0.193 | 0.197 |
| E | 5.80 | 6.00 | 6.20 | 0.228 | 0.236 | 0.244 |
| E1 | 3.80 | 3.90 | 4.00 | 0.150 | 0.154 | 0.157 |
| e | | 1.27 | | | 0.050 | |
| h | 0.25 | | 0.50 | 0.010 | | 0.020 |
| L | 0.40 | | 1.27 | 0.016 | | 0.050 |
| L1 | | 1.04 | | | 0.040 | |
| k | 1° | | 8° | 1° | | 8° |
| ccc | | | 0.10 | | | 0.004 |

5.6 TSSOP14 package information

Figure 28. TSSOP14 package mechanical drawing



Table 10. TSSOP14 package mechanical data

| Ref. | Dimensions | | | | | |
|------|-------------|------|------|--------|--------|--------|
| | Millimeters | | | Inches | | |
| | Min. | Typ. | Max. | Min. | Typ. | Max. |
| A | | | 1.20 | | | 0.047 |
| A1 | 0.05 | | 0.15 | 0.002 | 0.004 | 0.006 |
| A2 | 0.80 | 1.00 | 1.05 | 0.031 | 0.039 | 0.041 |
| b | 0.19 | | 0.30 | 0.007 | | 0.012 |
| c | 0.09 | | 0.20 | 0.004 | | 0.0089 |
| D | 4.90 | 5.00 | 5.10 | 0.193 | 0.197 | 0.201 |
| E | 6.20 | 6.40 | 6.60 | 0.244 | 0.252 | 0.260 |
| E1 | 4.30 | 4.40 | 4.50 | 0.169 | 0.173 | 0.176 |
| e | | 0.65 | | | 0.0256 | |
| L | 0.45 | 0.60 | 0.75 | 0.018 | 0.024 | 0.030 |
| L1 | | 1.00 | | | 0.039 | |
| k | 0 ° | | 8 ° | 0 ° | | 8 ° |
| aaa | | | 0.10 | | | 0.004 |

5.7 SO14 package information

Figure 29. SO14 package mechanical drawing

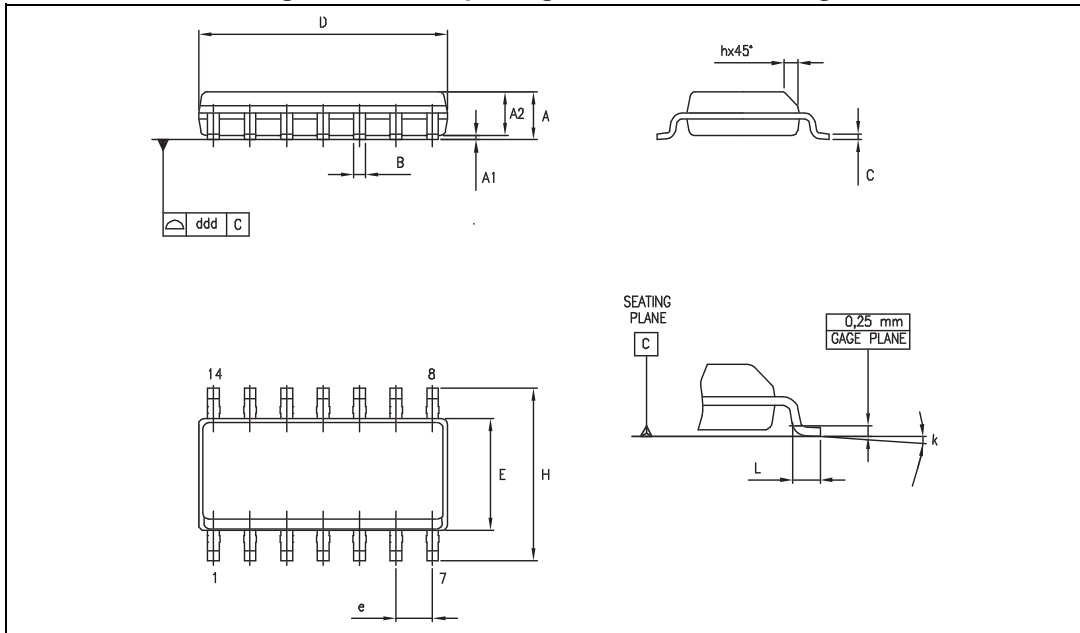

Table 11. SO14 package mechanical data

| Dimensions | | | | | | |
|------------|-------------|------|------|--------|------|-------|
| Ref. | Millimeters | | | Inches | | |
| | Min. | Typ. | Max. | Min. | Typ. | Max. |
| A | 1.35 | | 1.75 | 0.05 | | 0.068 |
| A1 | 0.10 | | 0.25 | 0.004 | | 0.009 |
| A2 | 1.10 | | 1.65 | 0.04 | | 0.06 |
| B | 0.33 | | 0.51 | 0.01 | | 0.02 |
| C | 0.19 | | 0.25 | 0.007 | | 0.009 |
| D | 8.55 | | 8.75 | 0.33 | | 0.34 |
| E | 3.80 | | 4.0 | 0.15 | | 0.15 |
| e | | 1.27 | | | 0.05 | |
| H | 5.80 | | 6.20 | 0.22 | | 0.24 |
| h | 0.25 | | 0.50 | 0.009 | | 0.02 |
| L | 0.40 | | 1.27 | 0.015 | | 0.05 |
| k | 8° (max.) | | | | | |
| ddd | | | 0.10 | | | 0.004 |

6 Ordering information

Table 12. Order codes

| Order code | Temperature range | Package | Packing | Marking |
|------------|-------------------|----------|---------------|---------|
| LMX321ICT | -40° C to +125° C | SC70-5 | Tape and reel | K21 |
| LMX321ILT | | SOT23-5 | | K430 |
| LMX358IQ2T | | DFN8 2x2 | | K21 |
| LMX358IST | | MiniSO8 | | K430 |
| LMX358IDT | | SO8 | | LMX358I |
| LMX324IPT | | TSSOP14 | | LMX324I |
| LMX324IDT | | SO14 | | LMX324I |

7 Revision history

Table 13. Document revision history

| Date | Revision | Changes |
|-------------|----------|---|
| 19-Mar-2012 | 1 | Initial release. |
| 06-Apr-2012 | 2 | Document status promoted from Target Specification to Production Data. |
| 07-May-2013 | 3 | Added DFN8 2x2 silhouette, pinout, and package Table 2: Absolute maximum ratings (AMR) : added R_{thja} data for DFN8 2x2 package. Table 12: Order codes : added LMX358IQ2T order code. |

Please Read Carefully:

Information in this document is provided solely in connection with ST products. STMicroelectronics NV and its subsidiaries ("ST") reserve the right to make changes, corrections, modifications or improvements, to this document, and the products and services described herein at any time, without notice.

All ST products are sold pursuant to ST's terms and conditions of sale.

Purchasers are solely responsible for the choice, selection and use of the ST products and services described herein, and ST assumes no liability whatsoever relating to the choice, selection or use of the ST products and services described herein.

No license, express or implied, by estoppel or otherwise, to any intellectual property rights is granted under this document. If any part of this document refers to any third party products or services it shall not be deemed a license grant by ST for the use of such third party products or services, or any intellectual property contained therein or considered as a warranty covering the use in any manner whatsoever of such third party products or services or any intellectual property contained therein.

UNLESS OTHERWISE SET FORTH IN ST'S TERMS AND CONDITIONS OF SALE ST DISCLAIMS ANY EXPRESS OR IMPLIED WARRANTY WITH RESPECT TO THE USE AND/OR SALE OF ST PRODUCTS INCLUDING WITHOUT LIMITATION IMPLIED WARRANTIES OF MERCHANTABILITY, FITNESS FOR A PARTICULAR PURPOSE (AND THEIR EQUIVALENTS UNDER THE LAWS OF ANY JURISDICTION), OR INFRINGEMENT OF ANY PATENT, COPYRIGHT OR OTHER INTELLECTUAL PROPERTY RIGHT.

ST PRODUCTS ARE NOT AUTHORIZED FOR USE IN WEAPONS. NOR ARE ST PRODUCTS DESIGNED OR AUTHORIZED FOR USE IN: (A) SAFETY CRITICAL APPLICATIONS SUCH AS LIFE SUPPORTING, ACTIVE IMPLANTED DEVICES OR SYSTEMS WITH PRODUCT FUNCTIONAL SAFETY REQUIREMENTS; (B) AERONAUTIC APPLICATIONS; (C) AUTOMOTIVE APPLICATIONS OR ENVIRONMENTS, AND/OR (D) AEROSPACE APPLICATIONS OR ENVIRONMENTS. WHERE ST PRODUCTS ARE NOT DESIGNED FOR SUCH USE, THE PURCHASER SHALL USE PRODUCTS AT PURCHASER'S SOLE RISK, EVEN IF ST HAS BEEN INFORMED IN WRITING OF SUCH USAGE, UNLESS A PRODUCT IS EXPRESSLY DESIGNATED BY ST AS BEING INTENDED FOR "AUTOMOTIVE, AUTOMOTIVE SAFETY OR MEDICAL" INDUSTRY DOMAINS ACCORDING TO ST PRODUCT DESIGN SPECIFICATIONS. PRODUCTS FORMALLY ESCC, QML OR JAN QUALIFIED ARE DEEMED SUITABLE FOR USE IN AEROSPACE BY THE CORRESPONDING GOVERNMENTAL AGENCY.

Resale of ST products with provisions different from the statements and/or technical features set forth in this document shall immediately void any warranty granted by ST for the ST product or service described herein and shall not create or extend in any manner whatsoever, any liability of ST.

ST and the ST logo are trademarks or registered trademarks of ST in various countries.

Information in this document supersedes and replaces all information previously supplied.

The ST logo is a registered trademark of STMicroelectronics. All other names are the property of their respective owners.

© 2013 STMicroelectronics - All rights reserved

STMicroelectronics group of companies

Australia - Belgium - Brazil - Canada - China - Czech Republic - Finland - France - Germany - Hong Kong - India - Israel - Italy - Japan - Malaysia - Malta - Morocco - Philippines - Singapore - Spain - Sweden - Switzerland - United Kingdom - United States of America

www.st.com





Стандарт Электрон Связь

Мы молодая и активно развивающаяся компания в области поставок электронных компонентов. Мы поставляем электронные компоненты отечественного и импортного производства напрямую от производителей и с крупнейших складов мира.

Благодаря сотрудничеству с мировыми поставщиками мы осуществляем комплексные и плановые поставки широчайшего спектра электронных компонентов.

Собственная эффективная логистика и склад в обеспечивает надежную поставку продукции в точно указанные сроки по всей России.

Мы осуществляем техническую поддержку нашим клиентам и предпродажную проверку качества продукции. На все поставляемые продукты мы предоставляем гарантию .

Осуществляем поставки продукции под контролем ВП МО РФ на предприятия военно-промышленного комплекса России , а также работаем в рамках 275 ФЗ с открытием отдельных счетов в уполномоченном банке. Система менеджмента качества компании соответствует требованиям ГОСТ ISO 9001.

Минимальные сроки поставки, гибкие цены, неограниченный ассортимент и индивидуальный подход к клиентам являются основой для выстраивания долгосрочного и эффективного сотрудничества с предприятиями радиоэлектронной промышленности, предприятиями ВПК и научно-исследовательскими институтами России.

С нами вы становитесь еще успешнее!

Наши контакты:

Телефон: +7 812 627 14 35

Электронная почта: sales@st-electron.ru

Адрес: 198099, Санкт-Петербург,
Промышленная ул, дом № 19, литера Н,
помещение 100-Н Офис 331