

1 What's in the box

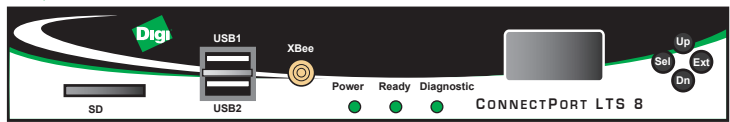

ConnectPort LTS

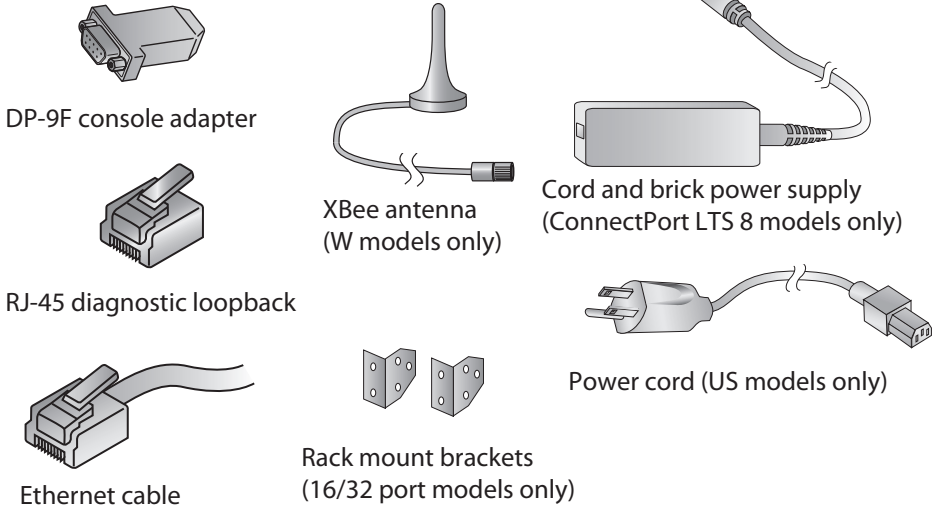

Quick Start Guide

ConnectPort® LTS 8/16/32



2 Connect the hardware

- a** Connect the Ethernet cable to the **Ethernet 1** port.
- b** Connect the serial devices to the serial ports, following the pin-position information below. If serial devices are EIA-422/485, see steps 4e and 4f.
- c** Connect the power supply to the **POWER** connector.
- d** W models only: Connect the Xbee antenna to the **XBEE** connector.

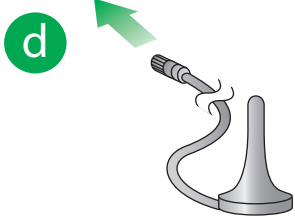
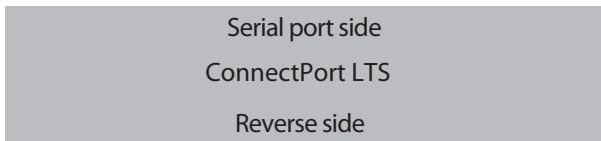
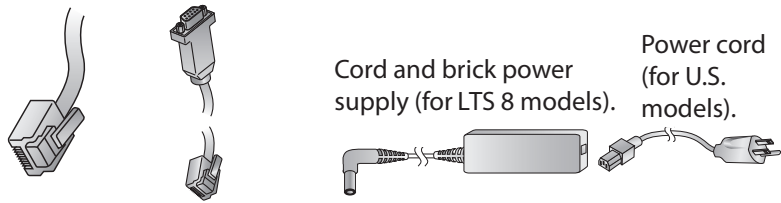

Ports, connectors, LEDs, and buttons:

ConnectPort LTS 8 - Serial port side

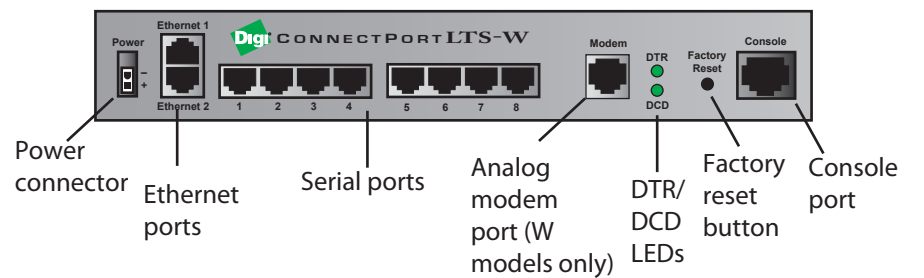

ConnectPort LTS 8 - Reverse side

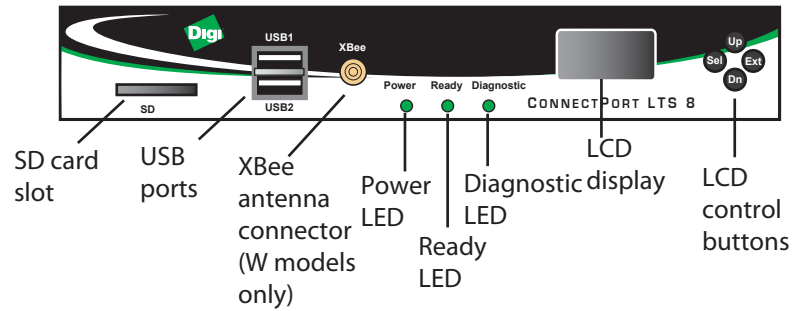

ConnectPort LTS 16/32 - Serial port side

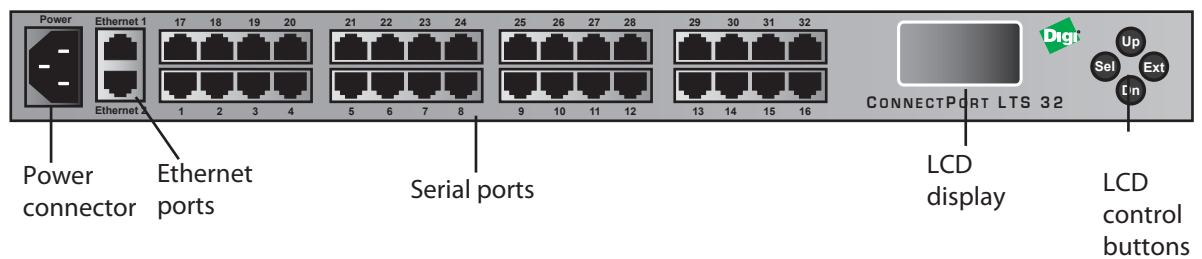

ConnectPort LTS 16/32 - Reverse side

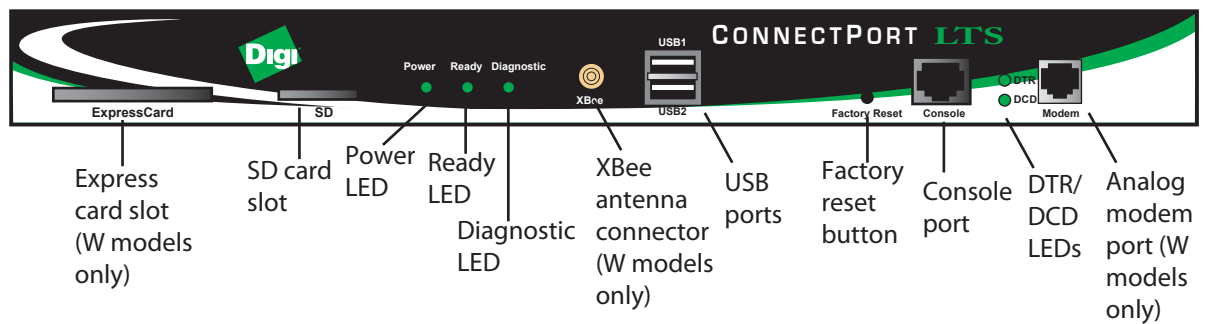

Pin positions for connecting serial devices:

10-wire jack (female):

ConnectPort LTS products use an RJ-45 10-wire jack (female), with Pin 1 in the following location:

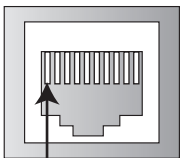

Pin 1

10-wire connector (male):

For a 10-wire connector, Pin 1 of the connector is in the following location:

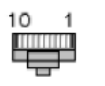

Insertion end



Top view

8-wire connector (male):

For an 8-wire connector, connect the pins to the center 8 pins of the 10-wire jack:



Insertion end



Top view

Serial port pin assignments:

Pin # on 10-wire connector	Pin # on 8-wire connector	MEI versions only:		
		EIA-232	EIA-422/485 Full-Duplex	EIA-485 Half-Duplex
1		RI	TxD-	N/A
2	1	DSR*	RxD-	DATA-
3	2	RTS	RTS+	N/A
4	3	CGND	CGND	CGND
5	4	TxD	TxD+	N/A
6	5	RxD	RxD+	DATA+
7	6	SGND	SGND	SGND
8	7	CTS	CTS+	N/A
9	8	DTR	RTS-	N/A
10		DCD*	CTS-	N/A

*Use the AltPin setting to swap these two signals.

ConnectPort LTS 16 Dual Power - Serial port side

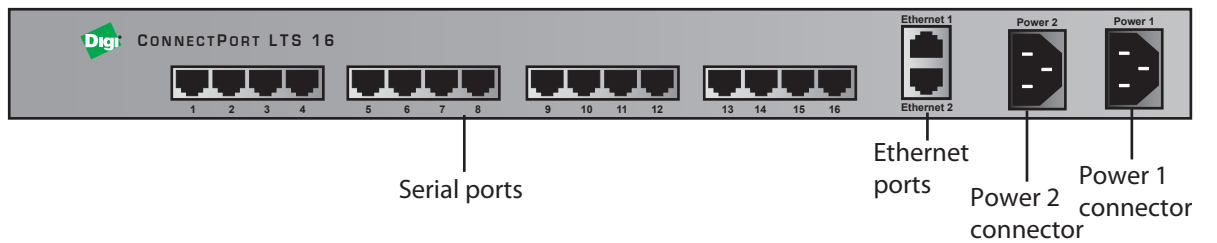

ConnectPort LTS 16 Dual Power - Reverse side

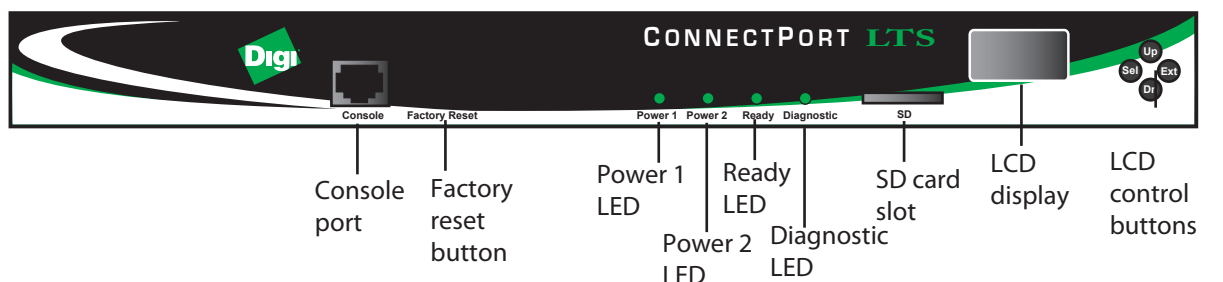

3 Download required software

- a** Digi provides several utilities that discover devices present on a network. You will need to download either the **Device Discovery Utility** or **Digi Port Authority - Remote**.
- Navigate to: www.digi.com/support/connectportlts.
 - Click the link **Diagnostics, Utilities, and MIBs**.
 - Select your operating system. A list of available downloadable utilities for your operating system is displayed.
 - Download and run either the **Device Discovery Utility** or **Digi Port Authority - Remote**.
- b** If the serial ports for your product will be managed using Digi's RealPort software, download the RealPort software.
- Navigate to: www.digi.com/support/connectportlts.
 - Click the link **Drivers**.
 - Select your operating system. A list of available downloads and release notes for your operating system is displayed.
 - Download the Realport driver and the release notes.
- For Microsoft Windows operating systems, unzip the download package and run the executable.
For Linux or Unix operating systems, unload the release notes first and follow the instructions in the release notes.

4 Configure the serial ports

- a** Navigate to www.digi.com/support/connectportlts. Click the **Documentation** link. Click **Users Guide: ConnectPort LTS / LTS MEI / LTS W / LTS MEI W** to open the *User Guide* for this product.
- b** Use the Device Discovery Utility or Digi Port Authority -- Remote to discover devices on your network and open the web interface:
- In the list of discovered devices, select the ConnectPort LTS device.
 - Using the Digi Discovery Utility or Digi Port Authority, configure the IP address if necessary. See *Alternative IP address setup using the LCD display* below.
 - Open the ConnectPort LTS web interface. In the Device Discovery Utility, click **Open web interface**. In Digi Port Authority-Remote, click **Device Configuration**.
 - A login prompt for the web interface is displayed. Enter the default username and password: **root** and **dbps**.

Alternative IP address setup using the LCD display

You can also set a static IP address using the LCD display and LCD control buttons.

- Press the **Sel** button to navigate to these settings: **CONFIGURATION > IP SETTINGS #1 > IP MODE:STATIC > IP ADDRESS > EDIT**.
- Use the **Up** and **Dn** buttons to select the correct IP address from the displayed addresses; press **Ext** when done.
- If necessary, change **SUBNET MASK** and **GATEWAY**.
- Press the **Ext** button to exit the configuration menus.
- To save the IP settings, use the **Dn** and **Sel** buttons to select the **SAVE** command.
- Press the **Ext** button to exit the LCD display.

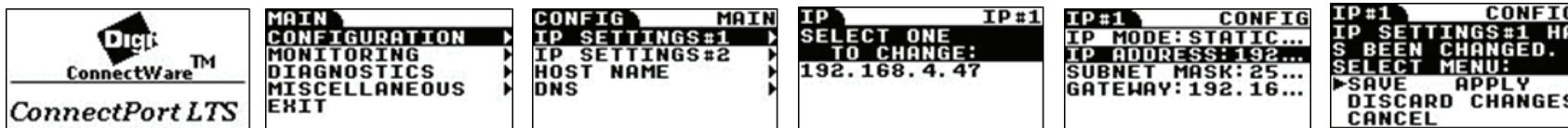

- c** In the web interface, under **Configuration**, click **Serial Ports**.
- d** Configure serial port settings using port profiles. Port profiles are a defined set of serial port parameters for a particular use. The web interface and User Guide contain descriptions of the port profiles. For ConnectPort LTS products, Digi recommends the **RealPort** port profile. For help in configuring the device for use with other port profiles, see the User Guide. To configure ports to use the RealPort port profile:
- On the **Serial Port Configuration** page, click the port to be configured.
 - Click **Change Profile**.
 - In the list of profiles, select the **RealPort** port profile.
 - Click **Apply**.
- e** For EIA-232 devices that will be connected using 8-wire cables, configure the **Altpin** setting. The default for this setting is off; it must be enabled as needed for each serial port. For each applicable serial port:
- Click **Advanced Serial Settings**.
 - Select the **Enable DCD on 8-pin RJ45 connectors (Altpin)** setting.
 - Click **Apply**.
- f** The serial ports for ConnectPort LTS MEI products are set to EIA-232 by default. For serial ports that connect to EIA-422 or EIA-485 devices, configure the serial ports. For each applicable serial port:
- Click the serial port to select it.
 - On the **Serial Port Configuration** page, click the link **Basic Serial Settings**.
 - For **MEI Type**, select **RS422/485** for EIA-422/485 4-wire Full-Duplex or **RS485-HALF** for EIA-485 2-wire Half-Duplex.
 - Select **Enable termination** if termination or use of biasing resistors is needed across the lines. Enable this setting if the terminal server port is an endpoint node of the EIA-422/485 network and termination or biasing is desired. If using 2-wire mode, termination or biasing is used at one of the end points; usually the Master endpoint.
- Note:** The **CTS** and **RTS** control signals are available as separate differential signals in the EIA-422/EIA-485 4-wire mode. Do not use these differential signals in 2-wire mode. The **CTS** and **RTS** differential signals are *not* terminated or biased internally. If termination or biasing is needed, it must be done externally.
- Click **Apply**.
- g** Your ConnectPort LTS device is now configured for basic serial port connectivity. For information on other configuration options and additional product information, see the *User Guide*.

5 Locate the appropriate cable adapters for your product

The table below lists EIA-232 cable adapters that can be used with ConnectPort LTS products.

For additional cabling information, go to www.digi.com/support/connectportlts and click the **Documentation** tab.

To order cables, go to the Digi Support site at www.digi.com/support and click **Cabling**.

Part Number	Cable Adapter	Application
76000697	Digi TS DB-9F Console Adapter (4-pk)	Bay Accelar, Nortel and other DB-9 DTE devices.
76000698	Digi TS DB-25M Console Adapter (4-pk)	Sun Sparc, Sun Ultra, terminal, printers and other DTE devices with DB-25 female ports.
76000699	Digi TS DB-25F Console Adapter (4-pk)	Cisco, IBM and other DTE devices with DB-25 male ports.
76000700	Digi TS DB-25M Modem Adapter (4-pk)	Modems and other DCE devices with DB-25 female ports.
76000701	Digi TS DB-9M Modem Adapter (4-pk)	Modems and other DCE devices with DB-9 female ports.
76000692	Digi TS DB-25M Printer Adapter (4-pk)	For use with printers. This adapter differs from a Console Adapter in that it uses the DTR signal instead of RTS for hardware flow control.
76000631	Digi TS to Sun Netra/Cisco Cable (single pk)	For use with Cisco and Sun RJ-45 Console ports. Also available in 8-pk and 16-pk quantities.
63000042-01	RJ-45 to RJ-45 Straight Through Ethernet Cable	Can be used as a networking cable or combined with one of the adapters as a serial cable.

Note: Cable adapters are 8-wire. If you are using these cable adapters with modems, or other applications that require Data Carrier Detect (DCD) control, you must enable the alternate pinout setting, or Altpin, as shown in step 4e.



Стандарт Электрон Связь

Мы молодая и активно развивающаяся компания в области поставок электронных компонентов. Мы поставляем электронные компоненты отечественного и импортного производства напрямую от производителей и с крупнейших складов мира.

Благодаря сотрудничеству с мировыми поставщиками мы осуществляем комплексные и плановые поставки широчайшего спектра электронных компонентов.

Собственная эффективная логистика и склад в обеспечивает надежную поставку продукции в точно указанные сроки по всей России.

Мы осуществляем техническую поддержку нашим клиентам и предпродажную проверку качества продукции. На все поставляемые продукты мы предоставляем гарантию .

Осуществляем поставки продукции под контролем ВП МО РФ на предприятия военно-промышленного комплекса России , а также работаем в рамках 275 ФЗ с открытием отдельных счетов в уполномоченном банке. Система менеджмента качества компании соответствует требованиям ГОСТ ISO 9001.

Минимальные сроки поставки, гибкие цены, неограниченный ассортимент и индивидуальный подход к клиентам являются основой для выстраивания долгосрочного и эффективного сотрудничества с предприятиями радиоэлектронной промышленности, предприятиями ВПК и научно-исследовательскими институтами России.

С нами вы становитесь еще успешнее!

Наши контакты:

Телефон: +7 812 627 14 35

Электронная почта: sales@st-electron.ru

Адрес: 198099, Санкт-Петербург,
Промышленная ул, дом № 19, литера Н,
помещение 100-Н Офис 331