

# BC847ATT1, BC847BTT1, BC847CTT1

## General Purpose Transistors

### NPN Silicon

These transistors are designed for general purpose amplifier applications. They are housed in the SC-75/SOT-416 package which is designed for low power surface mount applications.

#### Features

- Pb-Free Packages are Available\*

#### MAXIMUM RATINGS (T<sub>A</sub> = 25°C)

Rating	Symbol	Max	Unit
Collector-Emitter Voltage	V <sub>CEO</sub>	45	V
Collector-Base Voltage	V <sub>CBO</sub>	50	V
Emitter-Base Voltage	V <sub>EBO</sub>	6.0	V
Collector Current – Continuous	I <sub>C</sub>	100	mAdc

Maximum ratings are those values beyond which device damage can occur. Maximum ratings applied to the device are individual stress limit values (not normal operating conditions) and are not valid simultaneously. If these limits are exceeded, device functional operation is not implied, damage may occur and reliability may be affected.

#### THERMAL CHARACTERISTICS

Characteristic	Symbol	Max	Unit
Total Device Dissipation, FR-4 Board (Note 1) T <sub>A</sub> = 25°C Derated above 25°C	P <sub>D</sub>	200	mW
Thermal Resistance, Junction-to-Ambient (Note 1)	R <sub>θJA</sub>	600	°C/W
Total Device Dissipation, FR-4 Board (Note 2) T <sub>A</sub> = 25°C Derated above 25°C	P <sub>D</sub>	300	mW
Thermal Resistance, Junction-to-Ambient (Note 2)	R <sub>θJA</sub>	400	°C/W
Junction and Storage Temperature Range	T <sub>J</sub> , T <sub>stg</sub>	-55 to +150	°C

- FR-4 @ min pad.
- FR-4 @ 1.0 × 1.0 in pad.

\*For additional information on our Pb-Free strategy and soldering details, please download the ON Semiconductor Soldering and Mounting Techniques Reference Manual, SOLDERRM/D.



ON Semiconductor®

<http://onsemi.com>

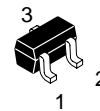
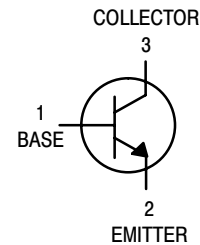

CASE 463  
SC-75/SOT-41  
6  
STYLE 1

#### MARKING DIAGRAM

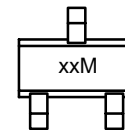

xx = Device Code  
M = Date Code

#### ORDERING INFORMATION

See detailed ordering and shipping information in the package dimensions section on page 5 of this data sheet.

# BC847ATT1, BC847BTT1, BC847CTT1

## ELECTRICAL CHARACTERISTICS (T<sub>A</sub> = 25°C unless otherwise noted)

Characteristic	Symbol	Min	Typ	Max	Unit
<b>OFF CHARACTERISTICS</b>					
Collector–Emitter Breakdown Voltage (I <sub>C</sub> = 10 mA)	BC847 Series V <sub>(BR)CEO</sub>	45	–	–	V
Collector–Emitter Breakdown Voltage (I <sub>C</sub> = 10 μA, V <sub>EB</sub> = 0)	BC847 Series V <sub>(BR)CES</sub>	50	–	–	V
Collector–Base Breakdown Voltage (I <sub>C</sub> = 10 μA)	BC847 Series V <sub>(BR)CBO</sub>	50	–	–	V
Emitter–Base Breakdown Voltage (I <sub>E</sub> = 1.0 μA)	BC847 Series V <sub>(BR)EBO</sub>	6.0	–	–	V
Collector Cutoff Current (V <sub>CB</sub> = 30 V) (V <sub>CB</sub> = 30 V, T <sub>A</sub> = 150°C)	I <sub>CBO</sub>	–	–	15 5.0	nA μA
<b>ON CHARACTERISTICS</b>					
DC Current Gain (I <sub>C</sub> = 10 μA, V <sub>CE</sub> = 5.0 V)	BC847A BC847B BC847C	h <sub>FE</sub>	–	90 150 270	–
(I <sub>C</sub> = 2.0 mA, V <sub>CE</sub> = 5.0 V)	BC847A BC847B BC847C		110 200 420	180 290 520	220 450 800
Collector–Emitter Saturation Voltage (I <sub>C</sub> = 10 mA, I <sub>B</sub> = 0.5 mA) (I <sub>C</sub> = 100 mA, I <sub>B</sub> = 5.0 mA)	V <sub>CE(sat)</sub>	–	–	0.25 0.6	V
Base–Emitter Saturation Voltage (I <sub>C</sub> = 10 mA, I <sub>B</sub> = 0.5 mA) (I <sub>C</sub> = 100 mA, I <sub>B</sub> = 5.0 mA)	V <sub>BE(sat)</sub>	–	0.7 0.9	–	V
Base–Emitter Voltage (I <sub>C</sub> = 2.0 mA, V <sub>CE</sub> = 5.0 V) (I <sub>C</sub> = 10 mA, V <sub>CE</sub> = 5.0 V)	V <sub>BE(on)</sub>	580	660	700 770	mV
<b>SMALL–SIGNAL CHARACTERISTICS</b>					
Current–Gain – Bandwidth Product (I <sub>C</sub> = 10 mA, V <sub>CE</sub> = 5.0 Vdc, f = 100 MHz)	f <sub>T</sub>	100	–	–	MHz
Output Capacitance (V <sub>CB</sub> = 10 V, f = 1.0 MHz)	C <sub>obo</sub>	–	–	4.5	pF
Noise Figure (I <sub>C</sub> = 0.2 mA, V <sub>CE</sub> = 5.0 Vdc, R <sub>S</sub> = 2.0 kΩ, f = 1.0 kHz, BW = 200 Hz)	NF	–	–	10	dB

# BC847ATT1, BC847BTT1, BC847CTT1

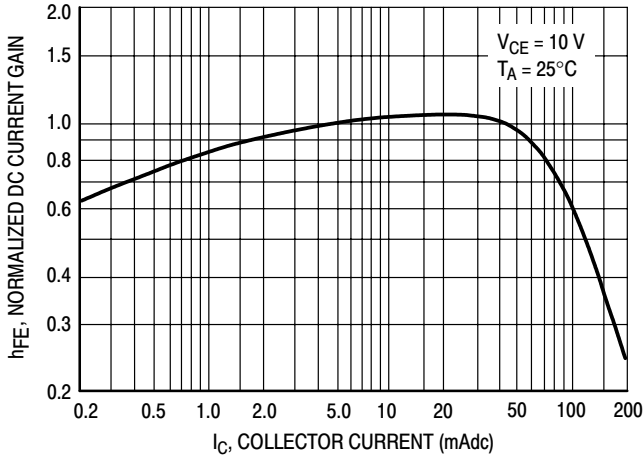

Figure 1. Normalized DC Current Gain

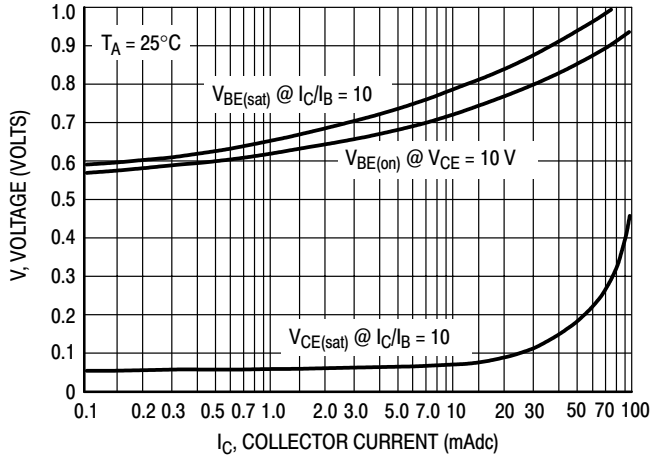

Figure 2. "Saturation" and "On" Voltages

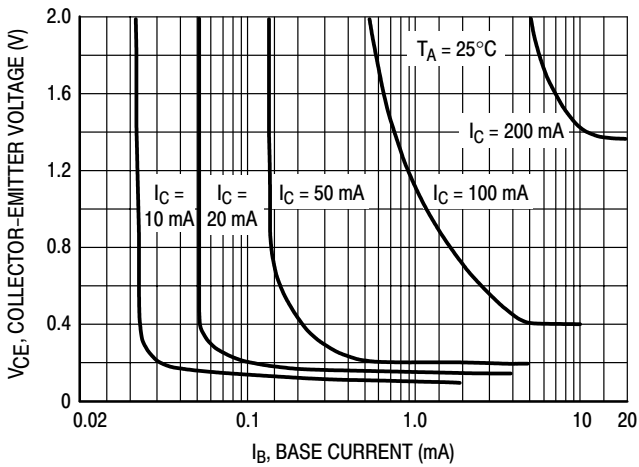

Figure 3. Collector Saturation Region

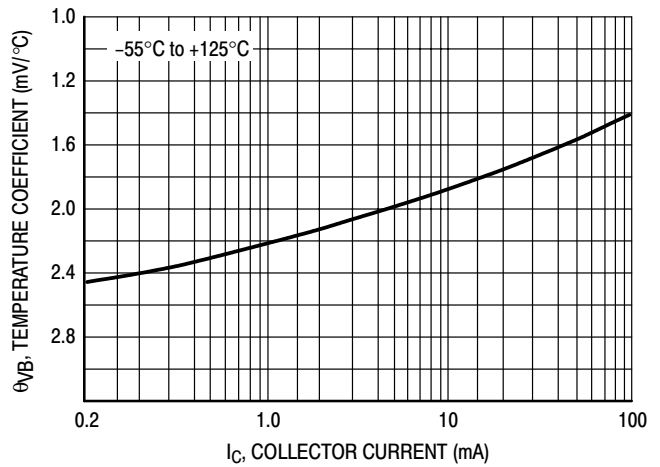

Figure 4. Base-Emitter Temperature Coefficient

# BC847ATT1, BC847BTT1, BC847CTT1

## BC847

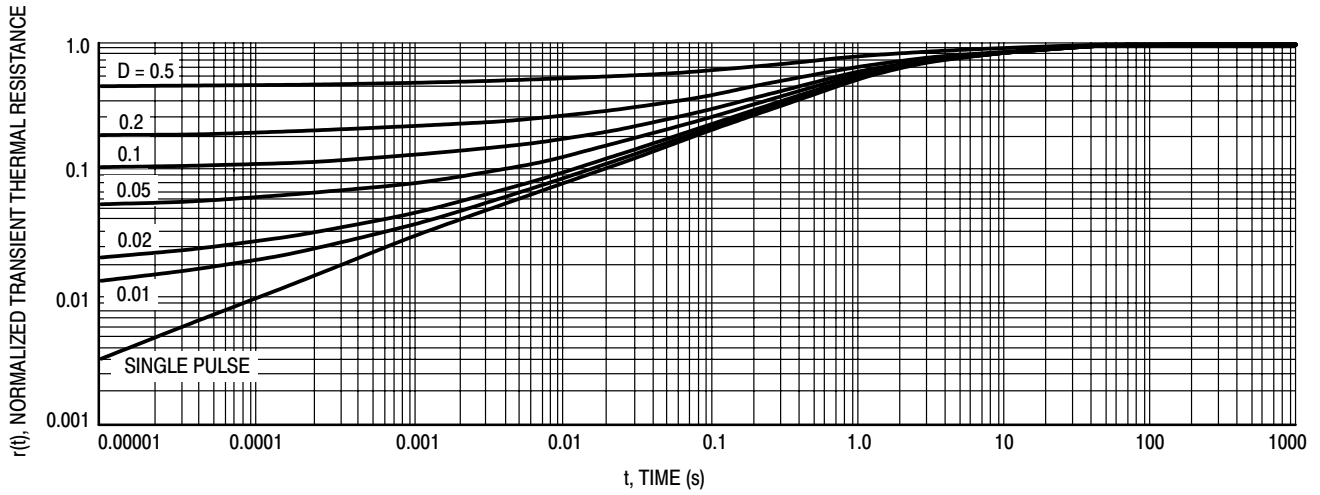

Figure 5. Normalized Thermal Response

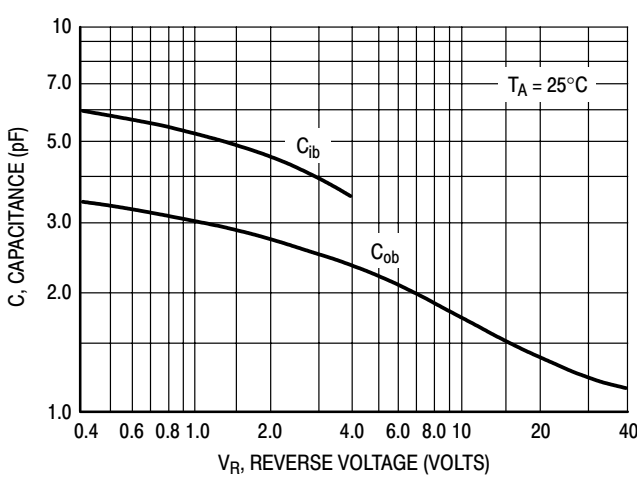

Figure 6. Capacitances

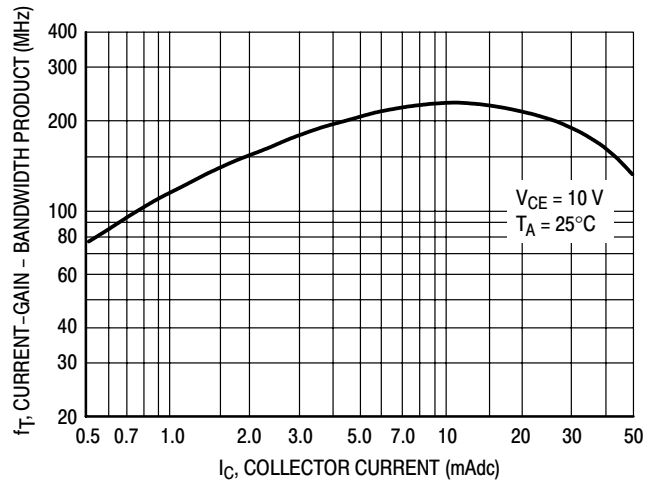

Figure 7. Current-Gain - Bandwidth Product

## BC847ATT1, BC847BTT1, BC847CTT1

### ORDERING INFORMATION

Device	Marking	Package	Shipping†
BC847ATT1	1E	SC-75/SOT-416	3,000 / Tape & Reel
BC847BTT1	1F	SC-75/SOT-416	3,000 / Tape & Reel
BC847BTT1G	1F	SC-75/SOT-416 (Pb-Free)	
BC847CTT1	1G	SC-75/SOT-416	3,000 / Tape & Reel
BC847CTT1G	1G	SC-75/SOT-416 (Pb-Free)	

†For information on tape and reel specifications, including part orientation and tape sizes, please refer to our Tape and Reel Packaging Specifications Brochure, BRD8011/D.

# BC847ATT1, BC847BTT1, BC847CTT1

## PACKAGE DIMENSIONS

SC-75/SOT-416  
CASE 463-01  
ISSUE C

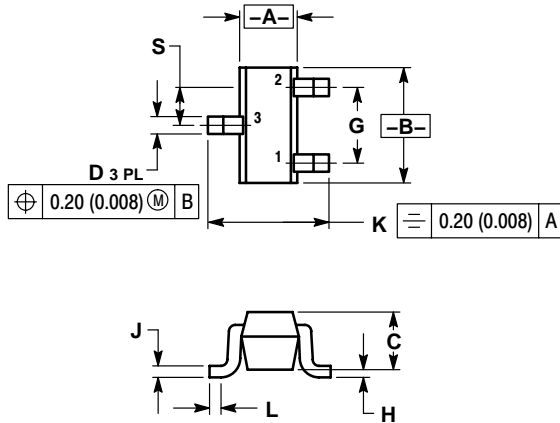

### NOTES:

1. DIMENSIONING AND TOLERANCING PER ANSI Y14.5M, 1982.
2. CONTROLLING DIMENSION: MILLIMETER.

DIM	MILLIMETERS		INCHES	
	MIN	MAX	MIN	MAX
A	0.70	0.90	0.028	0.035
B	1.40	1.80	0.055	0.071
C	0.60	0.90	0.024	0.035
D	0.15	0.30	0.006	0.012
G	1.00 BSC		0.039 BSC	
H	---	0.10	---	0.004
J	0.10	0.25	0.004	0.010
K	1.45	1.75	0.057	0.069
L	0.10	0.20	0.004	0.008
S	0.50 BSC		0.020 BSC	

ON Semiconductor and  are registered trademarks of Semiconductor Components Industries, LLC (SCILLC). SCILLC reserves the right to make changes without further notice to any products herein. SCILLC makes no warranty, representation or guarantee regarding the suitability of its products for any particular purpose, nor does SCILLC assume any liability arising out of the application or use of any product or circuit, and specifically disclaims any and all liability, including without limitation special, consequential or incidental damages. "Typical" parameters which may be provided in SCILLC data sheets and/or specifications can and do vary in different applications and actual performance may vary over time. All operating parameters, including "Typicals" must be validated for each customer application by customer's technical experts. SCILLC does not convey any license under its patent rights nor the rights of others. SCILLC products are not designed, intended, or authorized for use as components in systems intended for surgical implant into the body, or other applications intended to support or sustain life, or for any other application in which the failure of the SCILLC product could create a situation where personal injury or death may occur. Should Buyer purchase or use SCILLC products for any such unintended or unauthorized application, Buyer shall indemnify and hold SCILLC and its officers, employees, subsidiaries, affiliates, and distributors harmless against all claims, costs, damages, and expenses, and reasonable attorney fees arising out of, directly or indirectly, any claim of personal injury or death associated with such unintended or unauthorized use, even if such claim alleges that SCILLC was negligent regarding the design or manufacture of the part. SCILLC is an Equal Opportunity/Affirmative Action Employer. This literature is subject to all applicable copyright laws and is not for resale in any manner.

### PUBLICATION ORDERING INFORMATION

#### LITERATURE FULFILLMENT:

Literature Distribution Center for ON Semiconductor  
P.O. Box 61312, Phoenix, Arizona 85082-1312 USA  
Phone: 480-829-7710 or 800-344-3860 Toll Free USA/Canada  
Fax: 480-829-7709 or 800-344-3867 Toll Free USA/Canada  
Email: orderlit@onsemi.com

N. American Technical Support: 800-282-9855 Toll Free  
USA/Canada

Japan: ON Semiconductor, Japan Customer Focus Center  
2-9-1 Kamimeguro, Meguro-ku, Tokyo, Japan 153-0051  
Phone: 81-3-5773-3850

ON Semiconductor Website: <http://onsemi.com>

Order Literature: <http://www.onsemi.com/litorder>

For additional information, please contact your  
local Sales Representative.



## Стандарт Электрон Связь

Мы молодая и активно развивающаяся компания в области поставок электронных компонентов. Мы поставляем электронные компоненты отечественного и импортного производства напрямую от производителей и с крупнейших складов мира.

Благодаря сотрудничеству с мировыми поставщиками мы осуществляем комплексные и плановые поставки широчайшего спектра электронных компонентов.

Собственная эффективная логистика и склад в обеспечивает надежную поставку продукции в точно указанные сроки по всей России.

Мы осуществляем техническую поддержку нашим клиентам и предпродажную проверку качества продукции. На все поставляемые продукты мы предоставляем гарантию .

Осуществляем поставки продукции под контролем ВП МО РФ на предприятия военно-промышленного комплекса России , а также работаем в рамках 275 ФЗ с открытием отдельных счетов в уполномоченном банке. Система менеджмента качества компании соответствует требованиям ГОСТ ISO 9001.

Минимальные сроки поставки, гибкие цены, неограниченный ассортимент и индивидуальный подход к клиентам являются основой для выстраивания долгосрочного и эффективного сотрудничества с предприятиями радиоэлектронной промышленности, предприятиями ВПК и научно-исследовательскими институтами России.

С нами вы становитесь еще успешнее!

### Наши контакты:

**Телефон:** +7 812 627 14 35

**Электронная почта:** [sales@st-electron.ru](mailto:sales@st-electron.ru)

**Адрес:** 198099, Санкт-Петербург,  
Промышленная ул, дом № 19, литера Н,  
помещение 100-Н Офис 331