

FRACTIONAL-N SYNTHESIZER WITH INTEGRATED VCO, 990 - 1105 MHz

Features

- RF Bandwidth: 990 to 1105 MHz
- Ultra Low Phase Noise
-110 dBc/Hz in Band Typ.
- Figure of Merit (FOM) -227 dBc
- < 180 fs RMS Jitter
- 24-bit Step Size, Resolution 3 Hz typ
- Exact Frequency Mode
- Built-in Digital Self Test
- 40 Lead 6x6mm SMT Package: 36mm²

Typical Applications

- Cellular/4G Infrastructure
- Repeaters and Femtocells
- Communications Test Equipment
- CATV Equipment
- Phased Array Applications
- DDS Replacement
- Very High Data Rate Radios

Functional Diagram

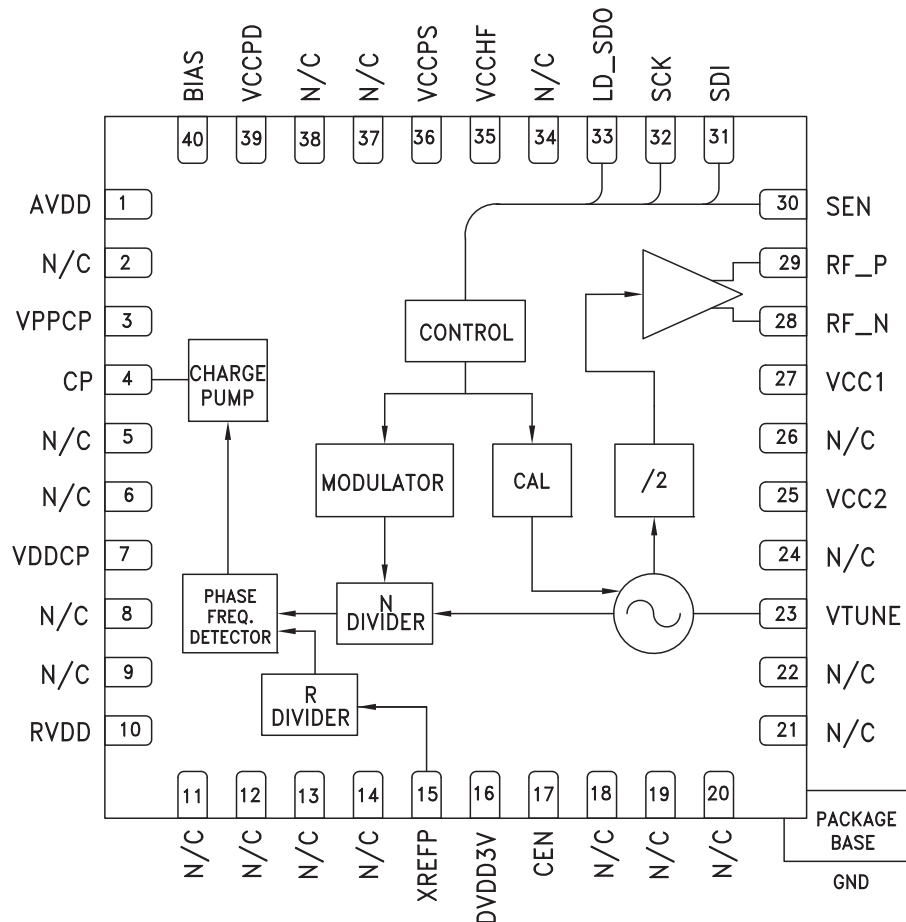



FRACTIONAL-N SYNTHESIZER WITH INTEGRATED VCO, 990 - 1105 MHz

General Description

The HMC826LP6CE is a fully featured Fractional-N Phase-Locked-Loop (PLL) Frequency Synthesizer with an Integrated Voltage Controlled Oscillator (VCO). The synthesizer consists of an integrated low noise VCO with divide-by-2 output, an autocalibration subsystem for low voltage VCO tuning, a very low noise digital Phase Detector (PD), a precision controlled charge pump, a low noise reference path divider and a fractional divider.

The fractional synthesizer features an advanced delta-sigma modulator design that allows both ultra-fine step sizes and low spurious products. The phase detector (PD) features cycle slip prevention (CSP) technology to allow faster frequency hopping times. Ultra low in-close phase noise and low spurious also allows wider loop bandwidths for faster frequency hopping and low micro-phonics.

For theory of operation and register map refer to the “PLLs w/ Integrated VCOs - RF VCOs Operating Guide”. To view the Operating Guide, please visit www.hittite.com and choose HMC826LP6CE from the “Search by Part Number” pull down menu.

Electrical Specifications, $T_A = +25^\circ\text{C}$

VPPCP, VDDCP, VCC1, VCC2 = 5V ±4%; RVDD, AVDD, DVDD3V, VCCPD, VCCHF, VCCPS = 3.3V ±6% GNDCP = GNDLS = Ground Paddle = 0V

Parameter	Condition	Min.	Typ.	Max.	Units
RF Output Characteristics					
VCO Frequency at PLL Input		1980		2210	MHz
RF Output Frequency at $f_{VCO}/2$		990		1105	MHz
RF Output Power at $f_{VCO}/2$		8	11	15	dBm
VCO Tuning Sensitivity	Measured at 2 GHz, 2V		15		MHz/V
VCO Supply Pushing	Measured at 2 GHz, 2V	-2		1.5	MHz/V
RF Output 2nd Harmonic			-25		dBc
RF Output 3rd Harmonic			-23		dBc
RF Output 4th Harmonic			-31		dBc
RF Output 5th Harmonic			-33		dBc
RF Divider Characteristics					
19-Bit N-Divider Range (Integer)	Max = $2^{19} - 1$	16		524,287	
19-Bit N-Divider Range (Fractional)	Fractional nominal divide ratio varies (-3 / +4) dynamically max	20		524,283	
REF Input Characteristics					
Max Ref Input Frequency	Synthesizer phase noise can degrade by about 5dB when operating with a reference frequency near the low end of this range.	10	50	200	MHz
Ref Input Range	AC Coupled	1.5	2	3.3	Vpp
Ref Input Capacitance				5	pF
14-Bit R-Divider Range		1		16,383	
Phase Detector (PD)					
PD Frequency Fractional Feedback Mode	[1]	0.1		100	MHz
PD Frequency Fractional Feedforward Mode (and Register 6 [17:16] = 10)		0.1		80	MHz
PD Frequency Integer Mode	[1]	0.1		125	MHz

Note 1: This maximum phase detector frequency can only be achieved if the minimum N value is respected. eg. In the case of fractional feedback mode, the maximum PFD rate = $f_{vco}/20$ or 100MHz, whichever is less.

**FRACTIONAL-N SYNTHESIZER WITH
INTEGRATED VCO, 990 - 1105 MHz**
Electrical Specifications (Continued)

Parameter	Condition	Min.	Typ.	Max.	Units
Charge Pump					
Max Output Current		0.02		2.54	mA
Charge Pump Gain Step Size (5-Bits)			500		μA
PD/Charge Pump SSB Phase Noise	50 MHz Ref, Input Referred				
1 kHz			-141		dBc/Hz
10 kHz	Add 1 dB for Fractional		-149		dBc/Hz
100 kHz	Add 3 dB for Fractional		-153		dBc/Hz
Logic Inputs					
VIH Input High Voltage		DVDD3V-0.4		DVDD3V	V
VIL Input Low Voltage		0		0.4	V
Logic Outputs					
VOH Output High Voltage		DVDD3V-0.4		DVDD3V	V
VOL Output Low Voltage		0		0.4	V
Power Supply Voltages					
Analog 3.3V Supplies	AVDD, VCCHF, VCCPS, VCCPD, RVDD	3.0	3.3	3.5	V
Digital Supply	DVDD3V	3.0	3.3	3.5	V
Analog 5V Supplies	VPPCP, VDDCP, VCC1, VCC2	4.8	5	5.2	V
Power Supply Currents					
+5V Analog Charge Pump	VPPCP, VDDCP		5.3		mA
+5V VCO Core and PLL Buffer	VCC2		56		mA
+5V VCO Divider and RF Buffer	VCC1		36		mA
+3.3V Analog	AVDD, VCCHF, VCCPS, VCCPD, RVDD		45		mA
+3.3V Digital	DVDD3V		6.5		mA
Power Down - Crystal Off	Reg 01h=0, Crystal Not Clocked		10		μA
Power Down - Crystal On, 100 MHz	Reg 01h=0, Crystal Clocked 100 MHz		10	200	μA
Power on Reset					
Typical Reset Voltage on DVDD			700		mV
Min DVDD Voltage for No Reset		1.5			V
Power on Reset Delay			250		μs
VCO Open Loop Phase Noise at $fvco/2$					
1 GHz Divide-by-2 Output	10 kHz Offset		-91		dBc/Hz
1 GHz Divide-by-2 Output	100 kHz Offset		-121		dBc/Hz
1 GHz Divide-by-2 Output	1 MHz Offset		-146		dBc/Hz
1 GHz Divide-by-2 Output	10 MHz Offset		-163		dBc/Hz
1 GHz Divide-by-2 Output	100 MHz Offset		-164		dBc/Hz
Closed Loop Phase Noise PLL + VCO at $fvco/2$					
1 GHz VCO, Integer, 50 MHz PFD	1 kHz Offset		-112		dBc/Hz
1 GHz VCO, Integer, 50 MHz PFD	10 kHz Offset		-114		dBc/Hz
1 GHz VCO, Integer, 50 MHz PFD	100 kHz Offset		-120		dBc/Hz
1 GHz VCO, Integer, 50 MHz PFD	1 MHz Offset		-146		dBc/Hz



**FRACTIONAL-N SYNTHESIZER WITH
INTEGRATED VCO, 990 - 1105 MHz**

Electrical Specifications (Continued)

Parameter	Condition	Min.	Typ.	Max.	Units
1 GHz VCO, Fractional, 50 MHz PFD	1 kHz Offset		-107		dBc/Hz
1 GHz VCO, Fractional, 50 MHz PFD	10 kHz Offset		-107		dBc/Hz
1 GHz VCO, Fractional, 50 MHz PFD	100 kHz Offset		-112		dBc/Hz
Figure of Merit	Normalized 1 Hz				
Integer Mode	Measured w/ 50 MHz PD at 30 kHz Offset		-229		dBc/Hz
Fractional Mode	Measured w/ 50 MHz PD at 30 kHz Offset		-227		dBc/Hz

Closed Loop Integer Phase Noise

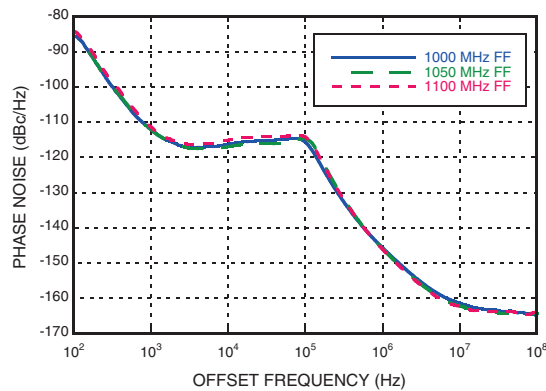

Typical Closed Loop Fractional Phase Noise [1]

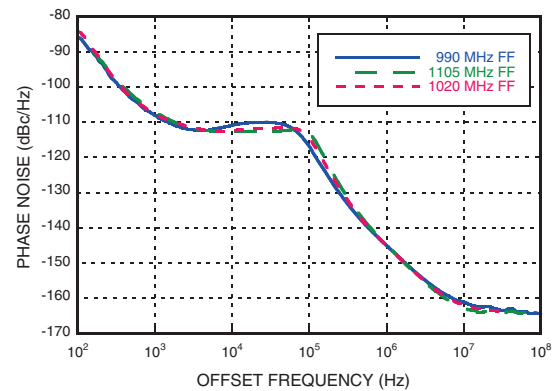

VCO/2 Free Running Phase Noise

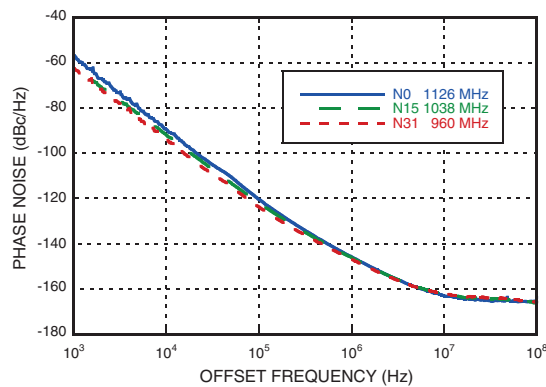

Typical VCO/2 Tuning Curves vs. Switch Position

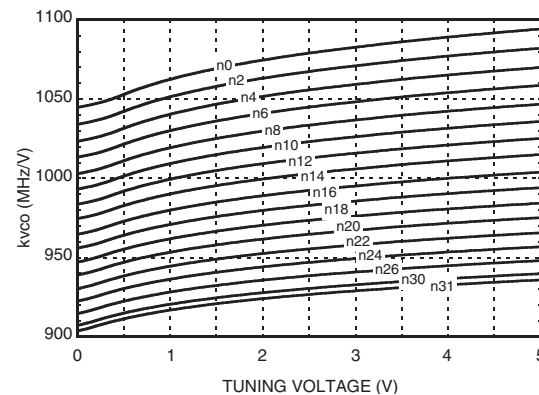

[1] Fractional Mode, 50 MHz Crystal, R=1, ~80 kHz Loop BW, Filter C36 = 560pF, R26 = 680Ω, C35 =15nF, R27 & R28 = 1 kΩ, C37 & C38 = 270 pF, 2mA Charge Pump, -385µA Offset.

FRACTIONAL-N SYNTHESIZER WITH INTEGRATED VCO, 990 - 1105 MHz

Free Running VCO Phase Noise (V_{TUNE} Set by AutoCal)

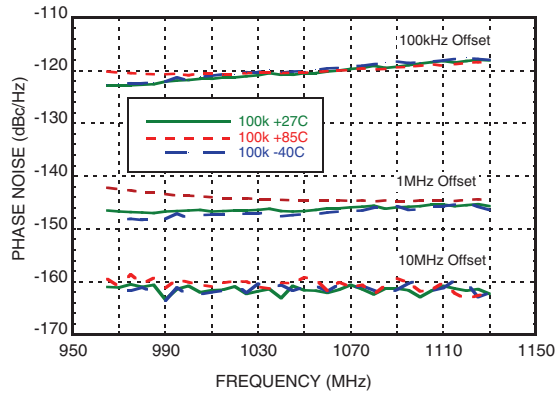

Typical VCO Tuning Voltage After Calibration

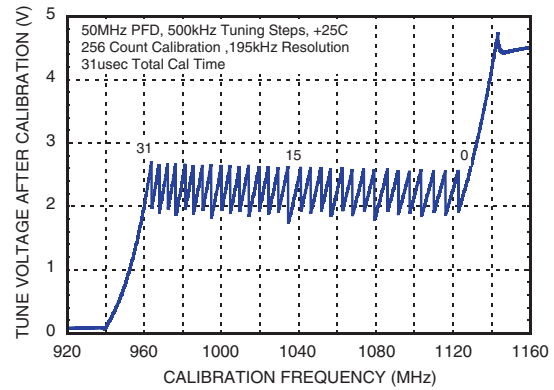

Typical VCO Sensitivity vs. Cap @ Fo Voltage

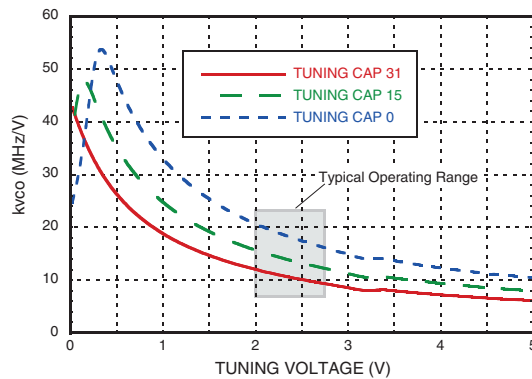

Typical Spurious at 200 kHz from Integer Boundary [1]

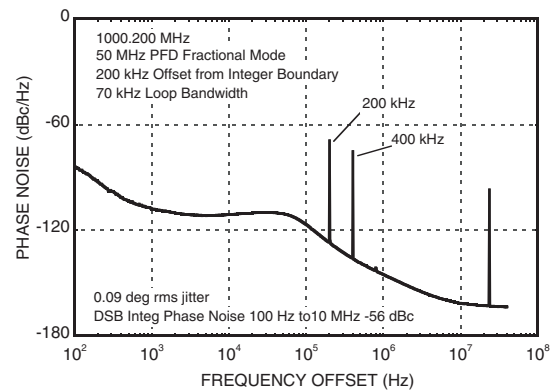

Typical Output Power - Narrow Band Match

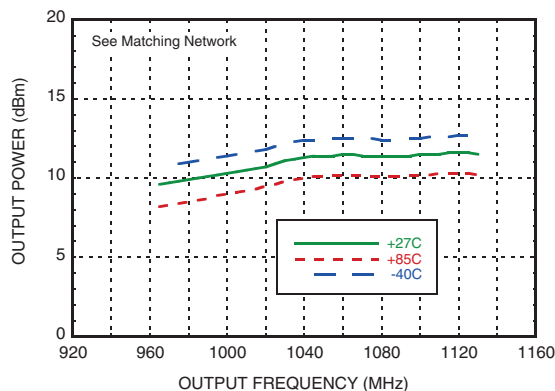
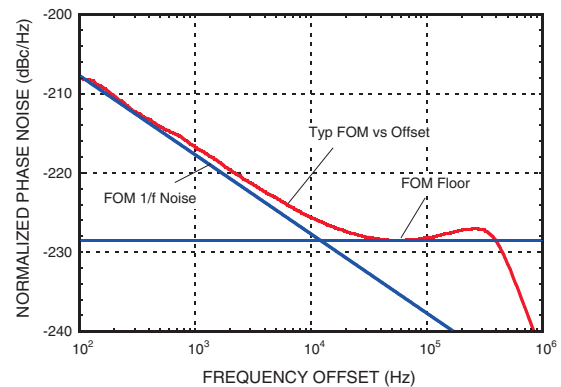

Figure of Merit



[1] Fractional Mode, 50 MHz Crystal, R=1, ~80 kHz Loop BW. (Loop filter values: C36 = 560pF, R26 = 680Ω, C35 = 15nF, R27 & R28 = 1 kΩ, C37 & C38 = 270 pF) 2mA Charge Pump, -385μA Offset.

**FRACTIONAL-N SYNTHESIZER WITH
INTEGRATED VCO, 990 - 1105 MHz**
Pin Descriptions

Pin Number	Function	Description
1	AVDD	DC Power Supply for analog circuitry.
2, 5, 6, 8, 9, 11 - 14, 18 - 22, 24, 26, 34, 37, 38	N/C	The pins are not connected internally; however, all data shown herein was measured with these pins connected to RF/DC ground externally.
3	VPPCP	Power Supply for charge pump analog section
4	CP	Charge Pump Output
7	VDDCP	Power Supply for the charge pump digital section
10	RVDD	Reference Supply
15	XREFP	Reference Oscillator Input
16	DVDD3V	DC Power Supply for Digital (CMOS) Circuitry
17	CEN	Chip Enable. Connect to logic high for normal operation.
23	VTUNE	VCO Varactor. Tuning Port Input.
25	VCC2	VCO Analog Supply 2
27	VCC1	VCO Analog Supply 1
28	RF_N	VCO Divide by 2 RF Positive Output
29	RF_P	VCO Divide by 2 RF Negative Output
30	SEN	PLL Serial Port Enable (CMOS) Logic Input
31	SDI	PLL Serial Port Data (CMOS) Logic Input
32	SCK	PLL Serial Port Clock (CMOS) Logic Input
33	LD_SDO	Lock Detect, or Serial Data, or General Purpose (CMOS) Logic Output (GPO)
35	VCCHF	DC Power Supply for Analog Circuitry
36	VCCPS	DC Power Supply for Analog Prescaler
39	VCCPD	DC Power Supply for Phase Detector
40	BIAS	External bypass decoupling for precision bias circuits. Note: 1.920V \pm 20mV reference voltage (BIAS) is generated internally and cannot drive an external load. Must be measured with 10G Ω meter such as Agilent 34410A, normal 10M Ω DVM will read erroneously.



**FRACTIONAL-N SYNTHESIZER WITH
INTEGRATED VCO, 990 - 1105 MHz**

Absolute Maximum Ratings

AVDD, RVDD, DVDD3V, VCCPD, VCCHF, VCCPS	-0.3V to +3.6V
VPPCP, VDDCP, VCC1	-0.3V to +5.8V
VCC2	-0.3V to +5.5V
Operating Temperature	-40°C to +85°C
Storage Temperature	-65°C to 125°C
Maximum Junction Temperature	125 °C
Thermal Resistance (R _{TH}) (junction to ground paddle)	20 °C/W
Reflow Soldering	
Peak Temperature	260°C
Time at Peak Temperature	40 sec
ESD Sensitivity (HBM)	Class 1B

Stresses above those listed under Absolute Maximum Ratings may cause permanent damage to the device. This is a stress rating only; functional operation of the device at these or any other conditions above those indicated in the operational section of this specification is not implied. Exposure to absolute maximum rating conditions for extended periods may affect device reliability.

FRACTIONAL-N SYNTHESIZER WITH INTEGRATED VCO, 990 - 1105 MHz

Outline Drawing

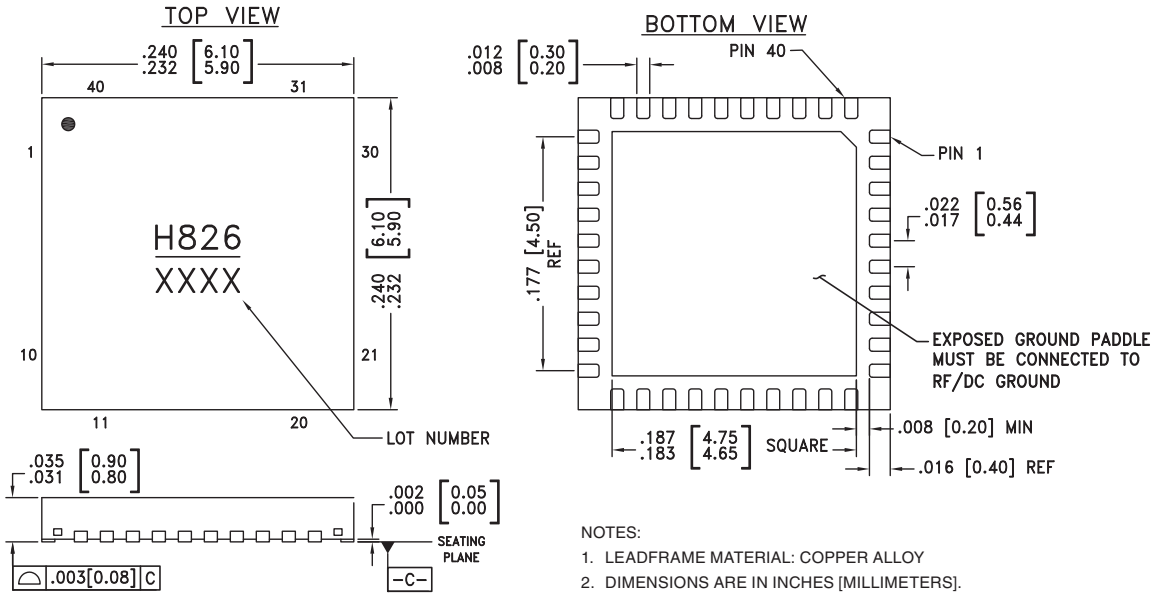

Package Information

Part Number	Package Body Material	Lead Finish	MSL Rating	Package Marking ^[1]
HMC826LP6CE	RoHS-compliant Low Stress Injection Molded Plastic	100% matte Sn	MSL1	H826 XXXX

[1] 4-Digit lot number XXXX



FRACTIONAL-N SYNTHESIZER WITH INTEGRATED VCO, 990 - 1105 MHz

Evaluation PCB

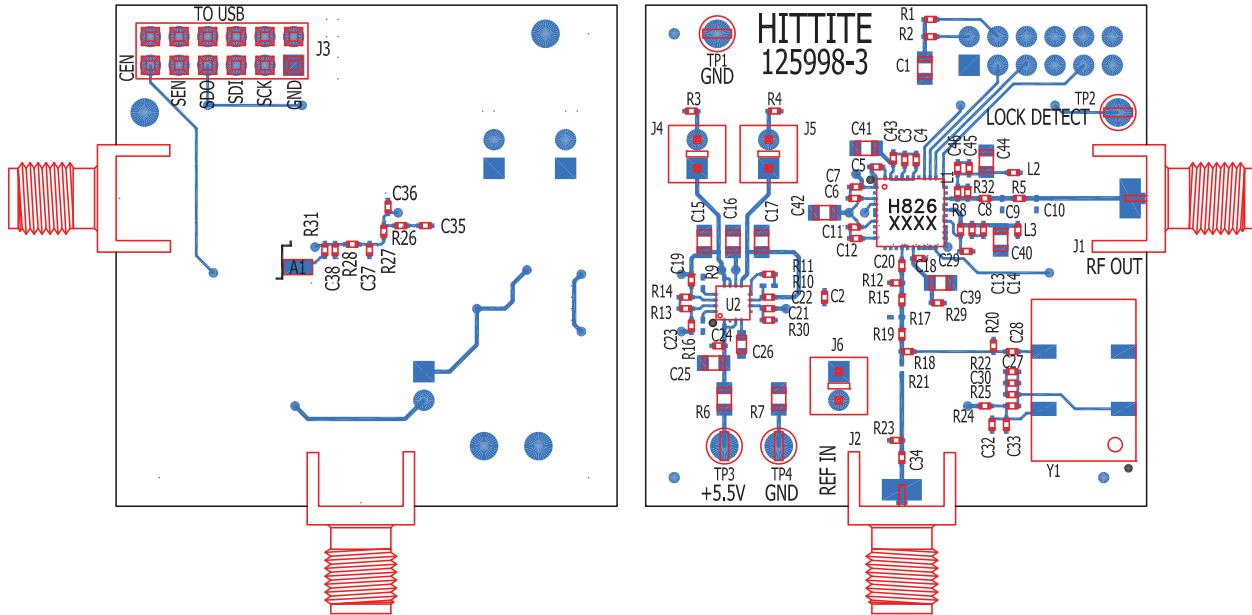

The circuit board used in the application should use RF circuit design techniques. Signal lines should have 50 Ohm impedance while the package ground leads and exposed paddle should be connected directly to the ground plane similar to that shown. A sufficient number of via holes should be used to connect the top and bottom ground planes. The evaluation circuit board shown is available from Hittite upon request.

Evaluation PCB Schematic

To view this [Evaluation PCB Schematic](#) please visit www.hittite.com and choose HMC826LP6CE from the "Search by Part Number" pull down menu to view the product splash page.

**FRACTIONAL-N SYNTHESIZER WITH
INTEGRATED VCO, 990 - 1105 MHz**
List of Materials for Evaluation PCB 127829 [1]

Item	Description
J1, J2	PCB Mount SMA RF Connector
J3	Dual Row Terminal Strip
J4 - J6	Connector Header
C1, C15 - C17, C25	10 μ F Capacitor, 0805 Pkg.
C2, C3, C6, C7, C11, C12, C14, C18, C27, C43, C45	0.47 μ F Capacitor, 0402 Pkg.
C4, C13	22 pF Capacitor, 0402 Pkg.
C5, C33	1000 pF Capacitor, 0402 Pkg.
C8	1.5 pF Capacitor, 0402 Pkg.
C19 - C24, C28, C30 - C32, C34	0.1 μ F Capacitor, 0402 Pkg.
C26	1 μ F Capacitor, 0603 Pkg.
C29	47 pF Capacitor, 0402 Pkg.
C35	3300 pF Capacitor, 0402 Pkg.
C36	270 pF Capacitor, 0402 Pkg.
C37, C38	68 pF Capacitor, 0402 Pkg.
C39 - C42, C44	4.7 μ F Tantalum Capacitor, 0805 Pkg
C46	27 pF Capacitor, 0402 Pkg.
R1, R2, R5, R11, R15, R18, R19, R21, R24	0 Ohm Resistor, 0402 Pkg.
R3, R4	1 Ohm Resistor, 0402 Pkg.
R6, R7	0 Ohm Resistor, 0805 Pkg.
R8	22 Ohm Resistor, 0402 Pkg.
R12, R20, R29	51 Ohm Resistor, 0402 Pkg.
R22, R25	20 kOhm Resistor, 0402 Pkg.
R26 - R28	1k Ohm Resistor, 0402 Pkg.
L1	8.2 nH Inductor, 0402 Pkg.
L2, L3	47 nH Inductor, 0402 Pkg.
TP3, TP4	Test Point PC Compact SMT
U1	HMC826LP6CE PLL with Integrated VCO
U2	HMC860LP3E Low Noise Quad Linear Regulator
Y1	3.3V, 50 MHz VCXO Crystal Oscillator
PCB [2]	125998 Evaluation Board

[1] Reference this number when ordering complete evaluation PCB

[2] Circuit Board Material: Rogers 4350 or Arlon 25FR and FR4



Стандарт Электрон Связь

Мы молодая и активно развивающаяся компания в области поставок электронных компонентов. Мы поставляем электронные компоненты отечественного и импортного производства напрямую от производителей и с крупнейших складов мира.

Благодаря сотрудничеству с мировыми поставщиками мы осуществляем комплексные и плановые поставки широчайшего спектра электронных компонентов.

Собственная эффективная логистика и склад в обеспечивает надежную поставку продукции в точно указанные сроки по всей России.

Мы осуществляем техническую поддержку нашим клиентам и предпродажную проверку качества продукции. На все поставляемые продукты мы предоставляем гарантию .

Осуществляем поставки продукции под контролем ВП МО РФ на предприятия военно-промышленного комплекса России , а также работаем в рамках 275 ФЗ с открытием отдельных счетов в уполномоченном банке. Система менеджмента качества компании соответствует требованиям ГОСТ ISO 9001.

Минимальные сроки поставки, гибкие цены, неограниченный ассортимент и индивидуальный подход к клиентам являются основой для выстраивания долгосрочного и эффективного сотрудничества с предприятиями радиоэлектронной промышленности, предприятиями ВПК и научно-исследовательскими институтами России.

С нами вы становитесь еще успешнее!

Наши контакты:

Телефон: +7 812 627 14 35

Электронная почта: sales@st-electron.ru

Адрес: 198099, Санкт-Петербург,
Промышленная ул, дом № 19, литера Н,
помещение 100-Н Офис 331