

# MC74HC374A

## Octal 3-State Non-Inverting D Flip-Flop

### High-Performance Silicon-Gate CMOS

The MC74HC374A is identical in pinout to the LS374. The device inputs are compatible with standard CMOS outputs; with pullup resistors, they are compatible with LSTTL outputs.

Data meeting the setup time is clocked to the outputs with the rising edge of the clock. The Output Enable input does not affect the states of the flip-flops, but when Output Enable is high, the outputs are forced to the high-impedance state; thus, data may be stored even when the outputs are not enabled.

The HC374A is identical in function to the HC574A which has the input pins on the opposite side of the package from the output. This device is similar in function to the HC534A which has inverting outputs.

#### Features

- Output Drive Capability: 15 LSTTL Loads
- Outputs Directly Interface to CMOS, NMOS, and TTL
- Operating Voltage Range: 2.0 to 6.0 V
- Low Input Current: 1.0  $\mu$ A
- High Noise Immunity Characteristic of CMOS Devices
- In Compliance with the Requirements Defined by JEDEC Standard No. 7 A
- Chip Complexity: 266 FETs or 66.5 Equivalent Gates
- These Devices are Pb-Free and are RoHS Compliant



ON Semiconductor®

<http://onsemi.com>

#### MARKING DIAGRAMS

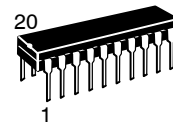

PDIP-20  
N SUFFIX  
CASE 738

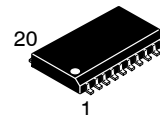
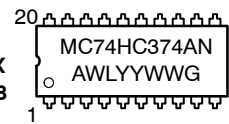

SOIC-20  
DW SUFFIX  
CASE 751D

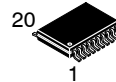
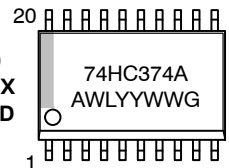

TSSOP-20  
DT SUFFIX  
CASE 948E

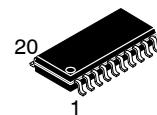
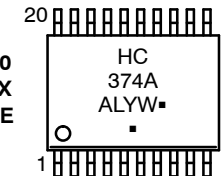

SOEIAJ-20  
F SUFFIX  
CASE 967



A = Assembly Location  
WL, L = Wafer Lot  
YY, Y = Year  
WW, W = Work Week  
G or ▪ = Pb-Free Package

(Note: Microdot may be in either location)

#### ORDERING INFORMATION

See detailed ordering and shipping information in the package dimensions section on page 2 of this data sheet.

# MC74HC374A

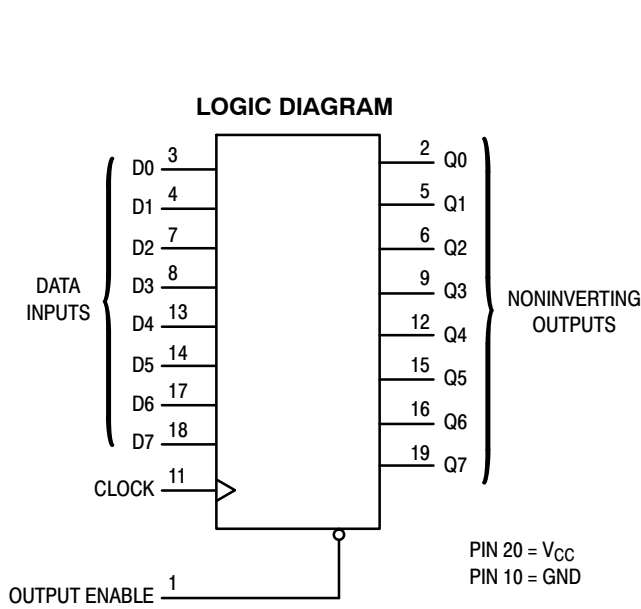

## PIN ASSIGNMENT

|               |     |    |                 |
|---------------|-----|----|-----------------|
| OUTPUT ENABLE | 1 ● | 20 | V <sub>CC</sub> |
| Q0            | 2   | 19 | Q7              |
| D0            | 3   | 18 | D7              |
| D1            | 4   | 17 | D6              |
| Q1            | 5   | 16 | Q6              |
| Q2            | 6   | 15 | Q5              |
| D2            | 7   | 14 | D5              |
| D3            | 8   | 13 | D4              |
| Q3            | 9   | 12 | Q4              |
| GND           | 10  | 11 | CLOCK           |

## FUNCTION TABLE

| Output Enable | Inputs |   | Output    |
|---------------|--------|---|-----------|
|               | Clock  | D | Q         |
| L             |        | H | H         |
| L             |        | L | L         |
| L             | L, H,  | X | No Change |
| H             | X      | X | Z         |

X = don't care

Z = high impedance

## ORDERING INFORMATION

| Device          | Package                   | Shipping†        |
|-----------------|---------------------------|------------------|
| MC74HC374ANG    | PDIP-20<br>(Pb-Free)      | 18 Units / Box   |
| MC74HC374ADWG   | SOIC-20 WIDE<br>(Pb-Free) | 38 Units / Rail  |
| MC74HC374ADWR2G | SOIC-20 WIDE<br>(Pb-Free) | 1000 Tape & Reel |
| MC74HC374ADTG   | TSSOP-20*                 | 75 Units / Rail  |
| MC74HC374ADTR2G | TSSOP-20*                 | 2500 Tape & Reel |
| MC74HC374AFG    | SOEIAJ-20<br>(Pb-Free)    | 40 Units / Rail  |
| MC74HC374AFELG  | SOEIAJ-20<br>(Pb-Free)    | 2000 Tape & Reel |

†For information on tape and reel specifications, including part orientation and tape sizes, please refer to our Tape and Reel Packaging Specifications Brochure, BRD8011/D.

\*This package is inherently Pb-Free.

# MC74HC374A

## MAXIMUM RATINGS

| Symbol    | Parameter   | Value                   | Unit |
|-----------|---|-------------------------|------|
| $V_{CC}$  | DC Supply Voltage (Referenced to GND)   | - 0.5 to + 7.0          | V    |
| $V_{in}$  | DC Input Voltage (Referenced to GND)  | - 0.5 to $V_{CC} + 0.5$ | V    |
| $V_{out}$ | DC Output Voltage (Referenced to GND)   | - 0.5 to $V_{CC} + 0.5$ | V    |
| $I_{in}$  | DC Input Current, per Pin   | $\pm 20$                | mA   |
| $I_{out}$ | DC Output Current, per Pin  | $\pm 35$                | mA   |
| $I_{CC}$  | DC Supply Current, $V_{CC}$ and GND Pins  | $\pm 75$                | mA   |
| $P_D$     | Power Dissipation in Still Air,<br>Plastic DIP†<br>SOIC Package†<br>TSSOP Package†            | 750<br>500<br>450       | mW   |
| $T_{stg}$ | Storage Temperature   | - 65 to + 150           | °C   |
| $T_L$     | Lead Temperature, 1 mm from Case for 10 Seconds<br>(Plastic DIP, SOIC, SSOP or TSSOP Package) | 260                     | °C   |

This device contains protection circuitry to guard against damage due to high static voltages or electric fields. However, precautions must be taken to avoid applications of any voltage higher than maximum rated voltages to this high-impedance circuit. For proper operation,  $V_{in}$  and  $V_{out}$  should be constrained to the range  $GND \leq (V_{in} \text{ or } V_{out}) \leq V_{CC}$ . Unused inputs must always be tied to an appropriate logic voltage level (e.g., either GND or  $V_{CC}$ ). Unused outputs must be left open.

Stresses exceeding Maximum Ratings may damage the device. Maximum Ratings are stress ratings only. Functional operation above the Recommended Operating Conditions is not implied. Extended exposure to stresses above the Recommended Operating Conditions may affect device reliability.

†Derating — Plastic DIP: - 10 mW/°C from 65° to 125°C  
SOIC Package: - 7 mW/°C from 65° to 125°C  
TSSOP Package: - 6.1 mW/°C from 65° to 125°C

## RECOMMENDED OPERATING CONDITIONS

| Symbol            | Parameter  | Min  | Max         | Unit               |    |
|-------------------|--|--|-------------|--------------------|----|
| $V_{CC}$          | DC Supply Voltage (Referenced to GND)                | 2.0  | 6.0         | V                  |    |
| $V_{in}, V_{out}$ | DC Input Voltage, Output Voltage (Referenced to GND) | 0  | $V_{CC}$    | V                  |    |
| $T_A$             | Operating Temperature, All Package Types             | - 55   | + 125       | °C                 |    |
| $t_r, t_f$        | Input Rise and Fall Time<br>(Figure 1)               | $V_{CC} = 2.0 \text{ V}$<br>$V_{CC} = 4.5 \text{ V}$<br>$V_{CC} = 6.0 \text{ V}$ | 0<br>0<br>0 | 1000<br>500<br>400 | ns |

## DC ELECTRICAL CHARACTERISTICS (Voltages Referenced to GND)

| Symbol   | Parameter                         | Test Conditions   | $V_{CC}$<br>V   | Guaranteed Limit |                         |                          | Unit          |   |
|----------|-----------------------------------|---|---|------------------|-------------------------|--------------------------|---------------|---|
|          |                                   |   |   | - 55 to<br>25°C  | $\leq 85^\circ\text{C}$ | $\leq 125^\circ\text{C}$ |               |   |
| $V_{IH}$ | Minimum High-Level Input Voltage  | $V_{out} = 0.1 \text{ V or } V_{CC} - 0.1 \text{ V}$<br>$ I_{out}  \leq 20 \mu\text{A}$ | 2.0   | 1.50             | 1.50                    | 1.50                     | V             |   |
|          |                                   |   | 3.0   | 2.10             | 2.10                    | 2.10                     |               |   |
|          |                                   |   | 4.5   | 3.15             | 3.15                    | 3.15                     |               |   |
|          |                                   |   | 6.0   | 4.20             | 4.20                    | 4.20                     |               |   |
| $V_{IL}$ | Maximum Low-Level Input Voltage   | $V_{out} = 0.1 \text{ V or } V_{CC} - 0.1 \text{ V}$<br>$ I_{out}  \leq 20 \mu\text{A}$ | 2.0   | 0.50             | 0.50                    | 0.50                     | V             |   |
|          |                                   |   | 3.0   | 0.90             | 0.90                    | 0.90                     |               |   |
|          |                                   |   | 4.5   | 1.35             | 1.35                    | 1.35                     |               |   |
|          |                                   |   | 6.0   | 1.80             | 1.80                    | 1.80                     |               |   |
| $V_{OH}$ | Minimum High-Level Output Voltage | $V_{in} = V_{IH} \text{ or } V_{IL}$<br>$ I_{out}  \leq 20 \mu\text{A}$                 | 2.0   | 1.90             | 1.90                    | 1.90                     | V             |   |
|          |                                   |   | 4.5   | 4.40             | 4.40                    | 4.40                     |               |   |
|          |                                   |   | 6.0   | 5.90             | 5.90                    | 5.90                     |               |   |
|          |                                   | $V_{in} = V_{IH} \text{ or } V_{IL}$  | $ I_{out}  \leq 2.4 \text{ mA}$<br>$ I_{out}  \leq 6.0 \text{ mA}$<br>$ I_{out}  \leq 7.8 \text{ mA}$ | 3.0              | 2.48                    | 2.34                     | 2.20          | V |
|          |                                   |   |   | 4.5              | 2.98                    | 3.84                     | 3.70          |   |
|          |                                   |   |   | 6.0              | 5.48                    | 5.34                     | 5.20          |   |
| $V_{OL}$ | Maximum Low-Level Output Voltage  | $V_{in} = V_{IH} \text{ or } V_{IL}$<br>$ I_{out}  \leq 20 \mu\text{A}$                 | 2.0   | 0.10             | 0.10                    | 0.10                     | V             |   |
|          |                                   |   | 4.5   | 0.10             | 0.10                    | 0.10                     |               |   |
|          |                                   |   | 6.0   | 0.10             | 0.10                    | 0.10                     |               |   |
|          |                                   | $V_{in} = V_{IH} \text{ or } V_{IL}$  | $ I_{out}  \leq 2.4 \text{ mA}$<br>$ I_{out}  \leq 6.0 \text{ mA}$<br>$ I_{out}  \leq 7.8 \text{ mA}$ | 3.0              | 0.26                    | 0.33                     | 0.40          | V |
|          |                                   |   |   | 4.5              | 0.26                    | 0.33                     | 0.40          |   |
|          |                                   |   |   | 6.0              | 0.26                    | 0.33                     | 0.40          |   |
| $I_{in}$ | Maximum Input Leakage Current     | $V_{in} = V_{CC} \text{ or GND}$  | 6.0   | $\pm 0.1$        | $\pm 1.0$               | $\pm 1.0$                | $\mu\text{A}$ |   |

# MC74HC374A

## DC ELECTRICAL CHARACTERISTICS (Voltages Referenced to GND)

| Symbol          | Parameter                                      | Test Conditions   | V <sub>CC</sub><br>V | Guaranteed Limit |        |         | Unit |
|-----------------|--|---|----------------------|------------------|--------|---------|------|
|                 |  |   |                      | - 55 to<br>25°C  | ≤ 85°C | ≤ 125°C |      |
| I <sub>OZ</sub> | Maximum Three-State Leakage Current            | Output in High-Impedance State<br>V <sub>in</sub> = V <sub>IL</sub> or V <sub>IH</sub><br>V <sub>out</sub> = V <sub>CC</sub> or GND | 6.0                  | ± 0.5            | ± 5.0  | ± 10    | μA   |
| I <sub>CC</sub> | Maximum Quiescent Supply Current (per Package) | V <sub>in</sub> = V <sub>CC</sub> or GND<br>I <sub>out</sub> = 0 μA   | 6.0                  | 4                | 40     | 160     | μA   |

## AC ELECTRICAL CHARACTERISTICS (C<sub>L</sub> = 50 pF, Input t<sub>r</sub> = t<sub>f</sub> = 6.0 ns)

| Symbol                               | Parameter  | V <sub>CC</sub><br>V                    | Guaranteed Limit |        |         | Unit |
|--------------------------------------|--|---|------------------|--------|---------|------|
|                                      |  |   | - 55 to<br>25°C  | ≤ 85°C | ≤ 125°C |      |
| f <sub>max</sub>                     | Maximum Clock Frequency (50% Duty Cycle)                                   | 2.0                                     | 6                | 5      | 4       | MHz  |
|                                      |  | 3.0                                     | 15               | 10     | 8       |      |
|                                      |  | 4.5                                     | 30               | 24     | 20      |      |
|                                      |  | 6.0                                     | 35               | 28     | 24      |      |
| t <sub>PLH</sub><br>t <sub>PHL</sub> | Maximum Propagation Delay, Input Clock to Q<br>(Figures 1 and 5)           | 2.0                                     | 125              | 155    | 190     | ns   |
|                                      |  | 3.0                                     | 80               | 110    | 130     |      |
|                                      |  | 4.5                                     | 25               | 31     | 38      |      |
|                                      |  | 6.0                                     | 21               | 26     | 32      |      |
| t <sub>PLZ</sub><br>t <sub>PHZ</sub> | Maximum Propagation Delay, Output Enable to Q<br>(Figures 3 and 6)         | 2.0                                     | 150              | 190    | 225     | ns   |
|                                      |  | 3.0                                     | 100              | 125    | 150     |      |
|                                      |  | 4.5                                     | 30               | 38     | 45      |      |
|                                      |  | 6.0                                     | 26               | 33     | 38      |      |
| t <sub>PZL</sub><br>t <sub>PZH</sub> | Maximum Propagation Delay, Output Enable to Q<br>(Figures 3 and 6)         | 2.0                                     | 150              | 190    | 225     | ns   |
|                                      |  | 3.0                                     | 100              | 125    | 150     |      |
|                                      |  | 4.5                                     | 30               | 38     | 45      |      |
|                                      |  | 6.0                                     | 26               | 33     | 38      |      |
| t <sub>TLH</sub><br>t <sub>THL</sub> | Maximum Output Transition Time, Any Output<br>(Figures 1 and 5)            | 2.0                                     | 75               | 95     | 110     | ns   |
|                                      |  | 3.0                                     | 27               | 32     | 36      |      |
|                                      |  | 4.5                                     | 15               | 19     | 22      |      |
|                                      |  | 6.0                                     | 13               | 16     | 19      |      |
| C <sub>in</sub>                      | Maximum Input Capacitance  |   | 10               | 10     | 10      | pF   |
| C <sub>out</sub>                     | Maximum Three-State Output Capacitance<br>(Output in High-Impedance State) |   | 15               | 15     | 15      | pF   |
| C <sub>PD</sub>                      | Power Dissipation Capacitance (Per Enabled Output)*                        | Typical @ 25°C, V <sub>CC</sub> = 5.0 V |                  |        | pF      |      |
|                                      |  | 34                                      |                  |        |         |      |

\* Used to determine the no-load dynamic power consumption: P<sub>D</sub> = C<sub>PD</sub> V<sub>CC</sub><sup>2</sup>f + I<sub>CC</sub> V<sub>CC</sub>.

# MC74HC374A

## TIMING REQUIREMENTS ( $C_L = 50$ pF, Input $t_r = t_f = 6.0$ ns)

| Symbol                          | Parameter                         | Figure | V <sub>CC</sub> Volts | Guaranteed Limit |      |         |      |          |      | Unit |
|---------------------------------|-----------------------------------|--------|-----------------------|------------------|------|---------|------|----------|------|------|
|                                 |                                   |        |                       | - 55 to 25 °C    |      | ≤ 85 °C |      | ≤ 125 °C |      |      |
|                                 |                                   |        |                       | Min              | Max  | Min     | Max  | Min      | Max  |      |
| t <sub>su</sub>                 | Minimum Setup Time, Data to Clock | 3      | 2.0                   | 50               |      | 65      |      | 75       |      | ns   |
|                                 |                                   |        | 3.0                   | 40               |      | 50      |      | 60       |      |      |
|                                 |                                   |        | 4.5                   | 10               |      | 13      |      | 15       |      |      |
|                                 |                                   |        | 6.0                   | 9                |      | 11      |      | 13       |      |      |
| t <sub>h</sub>                  | Minimum Hold Time, Clock to Data  | 3      | 2.0                   | 5.0              |      | 5.0     |      | 5.0      |      | ns   |
|                                 |                                   |        | 3.0                   | 5.0              |      | 5.0     |      | 5.0      |      |      |
|                                 |                                   |        | 4.5                   | 5.0              |      | 5.0     |      | 5.0      |      |      |
|                                 |                                   |        | 6.0                   | 5.0              |      | 5.0     |      | 5.0      |      |      |
| t <sub>w</sub>                  | Minimum Pulse Width, Clock        | 1      | 2.0                   | 60               |      | 75      |      | 90       |      | ns   |
|                                 |                                   |        | 3.0                   | 23               |      | 27      |      | 32       |      |      |
|                                 |                                   |        | 4.5                   | 12               |      | 15      |      | 18       |      |      |
|                                 |                                   |        | 6.0                   | 10               |      | 13      |      | 15       |      |      |
| t <sub>r</sub> , t <sub>f</sub> | Maximum Input Rise and Fall Times | 1      | 2.0                   |                  | 1000 |         | 1000 |          | 1000 | ns   |
|                                 |                                   |        | 3.0                   |                  | 800  |         | 800  |          | 800  |      |
|                                 |                                   |        | 4.5                   |                  | 500  |         | 500  |          | 500  |      |
|                                 |                                   |        | 6.0                   |                  | 400  |         | 400  |          | 400  |      |

## SWITCHING WAVEFORMS

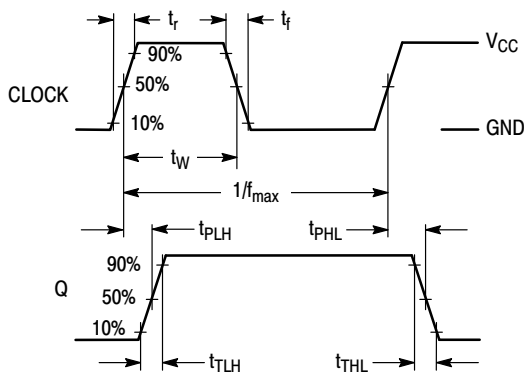

Figure 1.

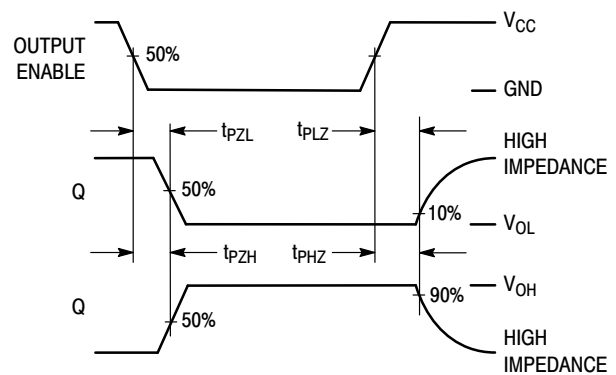

Figure 2.

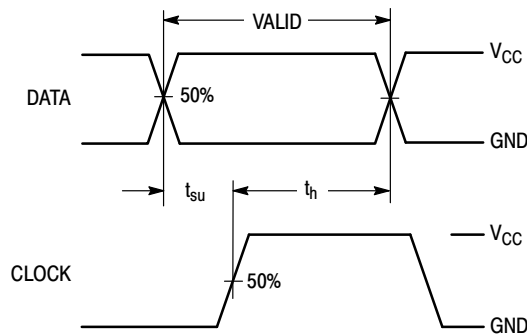
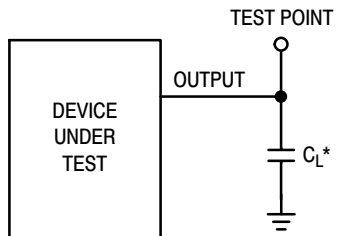

Figure 3.

# MC74HC374A

## TEST CIRCUITS



\*Includes all probe and jig capacitance

Figure 4.

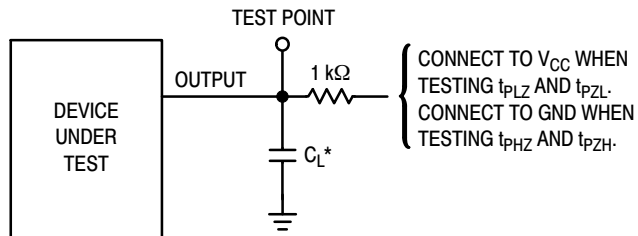

\*Includes all probe and jig capacitance

Figure 5.

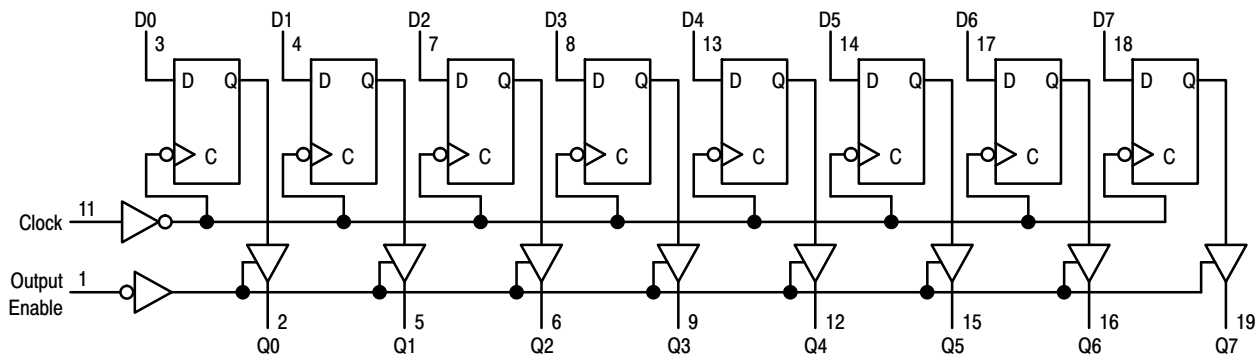

Figure 6. Expanded Logic Diagram

# MC74HC374A

## PACKAGE DIMENSIONS

PDIP-20  
N SUFFIX  
PLASTIC DIP PACKAGE  
CASE 738-03  
ISSUE E



- NOTES:
1. DIMENSIONING AND TOLERANCING PER ANSI Y14.5M, 1982.
  2. CONTROLLING DIMENSION: INCH.
  3. DIMENSION L TO CENTER OF LEAD WHEN FORMED PARALLEL.
  4. DIMENSION B DOES NOT INCLUDE MOLD FLASH.

| DIM | INCHES    |       | MILLIMETERS |       |
|-----|-----------|-------|-------------|-------|
|     | MIN       | MAX   | MIN         | MAX   |
| A   | 1.010     | 1.070 | 25.66       | 27.17 |
| B   | 0.240     | 0.260 | 6.10        | 6.60  |
| C   | 0.150     | 0.180 | 3.81        | 4.57  |
| D   | 0.015     | 0.022 | 0.39        | 0.55  |
| E   | 0.050 BSC |       | 1.27 BSC    |       |
| F   | 0.050     | 0.070 | 1.27        | 1.77  |
| G   | 0.100 BSC |       | 2.54 BSC    |       |
| J   | 0.008     | 0.015 | 0.21        | 0.38  |
| K   | 0.110     | 0.140 | 2.80        | 3.55  |
| L   | 0.300 BSC |       | 7.62 BSC    |       |
| M   | 0°        | 15°   | 0°          | 15°   |
| N   | 0.020     | 0.040 | 0.51        | 1.01  |

SOIC-20  
DW SUFFIX  
CASE 751D-05  
ISSUE G

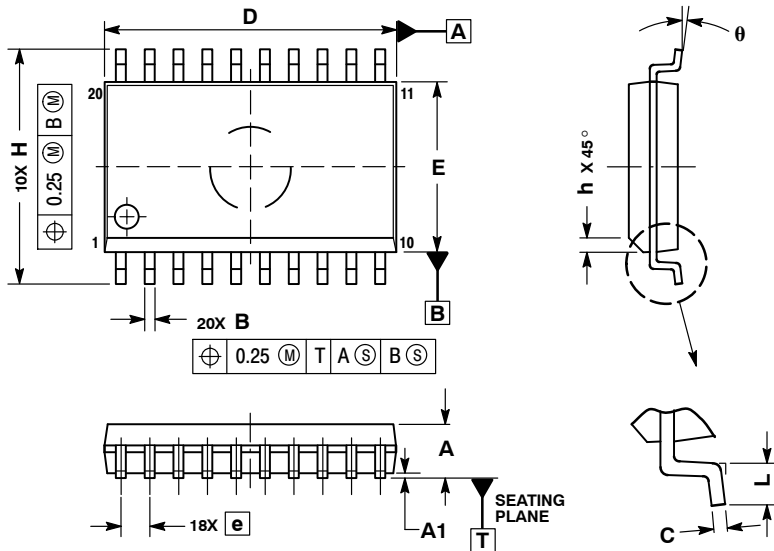

- NOTES:
1. DIMENSIONS ARE IN MILLIMETERS.
  2. INTERPRET DIMENSIONS AND TOLERANCES PER ASME Y14.5M, 1994.
  3. DIMENSIONS D AND E DO NOT INCLUDE MOLD PROTRUSION.
  4. MAXIMUM MOLD PROTRUSION 0.15 PER SIDE.
  5. DIMENSION B DOES NOT INCLUDE DAMBAR PROTRUSION. ALLOWABLE PROTRUSION SHALL BE 0.13 TOTAL IN EXCESS OF B DIMENSION AT MAXIMUM MATERIAL CONDITION.

| DIM      | MILLIMETERS |       |
|----------|-------------|-------|
|          | MIN         | MAX   |
| A        | 2.35        | 2.65  |
| A1       | 0.10        | 0.25  |
| B        | 0.35        | 0.49  |
| C        | 0.23        | 0.32  |
| D        | 12.65       | 12.95 |
| E        | 7.40        | 7.60  |
| e        | 1.27 BSC    |       |
| H        | 10.05       | 10.55 |
| h        | 0.25        | 0.75  |
| L        | 0.50        | 0.90  |
| $\theta$ | 0°          | 7°    |

# MC74HC374A

## PACKAGE DIMENSIONS

TSSOP-20  
DT SUFFIX  
CASE 948E-02  
ISSUE C



- NOTES:
1. DIMENSIONING AND TOLERANCING PER ANSI Y14.5M, 1982.
  2. CONTROLLING DIMENSION: MILLIMETER.
  3. DIMENSION A DOES NOT INCLUDE MOLD FLASH, PROTRUSIONS OR GATE BURRS. MOLD FLASH OR GATE BURRS SHALL NOT EXCEED 0.15 (0.006) PER SIDE.
  4. DIMENSION B DOES NOT INCLUDE INTERLEAD FLASH OR PROTRUSION. INTERLEAD FLASH OR PROTRUSION SHALL NOT EXCEED 0.25 (0.010) PER SIDE.
  5. DIMENSION K DOES NOT INCLUDE DAMBAR PROTRUSION. ALLOWABLE DAMBAR PROTRUSION SHALL BE 0.08 (0.003) TOTAL IN EXCESS OF THE K DIMENSION AT MAXIMUM MATERIAL CONDITION.
  6. TERMINAL NUMBERS ARE SHOWN FOR REFERENCE ONLY.
  7. DIMENSION A AND B ARE TO BE DETERMINED AT DATUM PLANE -W-.

| DIM | MILLIMETERS |      | INCHES    |       |
|-----|-------------|------|-----------|-------|
|     | MIN         | MAX  | MIN       | MAX   |
| A   | 6.40        | 6.60 | 0.252     | 0.260 |
| B   | 4.30        | 4.50 | 0.169     | 0.177 |
| C   | ---         | 1.20 | ---       | 0.047 |
| D   | 0.05        | 0.15 | 0.002     | 0.006 |
| F   | 0.50        | 0.75 | 0.020     | 0.030 |
| G   | 0.65 BSC    |      | 0.026 BSC |       |
| H   | 0.27        | 0.37 | 0.011     | 0.015 |
| J   | 0.09        | 0.20 | 0.004     | 0.008 |
| J1  | 0.09        | 0.16 | 0.004     | 0.006 |
| K   | 0.19        | 0.30 | 0.007     | 0.012 |
| K1  | 0.19        | 0.25 | 0.007     | 0.010 |
| L   | 6.40 BSC    |      | 0.252 BSC |       |
| M   | 0°          | 8°   | 0°        | 8°    |

### SOLDERING FOOTPRINT

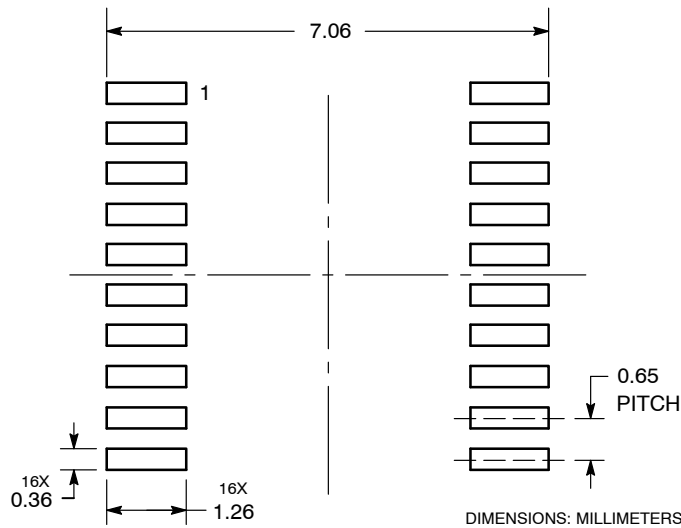



# MC74HC374A

## PACKAGE DIMENSIONS

SOEIAJ-20  
F SUFFIX  
CASE 967-01  
ISSUE A

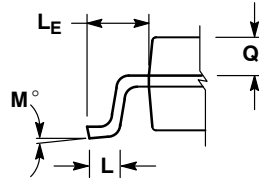
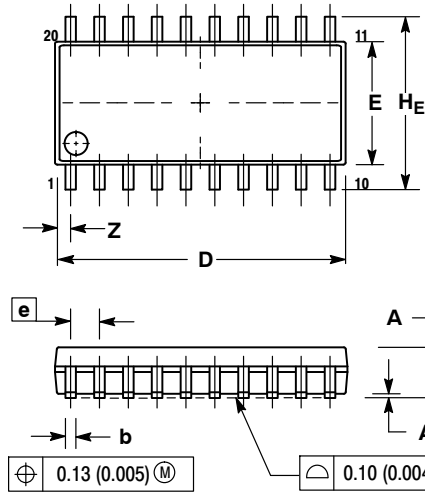

DETAIL P



NOTES:

1. DIMENSIONING AND TOLERANCING PER ANSI Y14.5M, 1982.
2. CONTROLLING DIMENSION: MILLIMETER.
3. DIMENSIONS D AND E DO NOT INCLUDE MOLD FLASH OR PROTRUSIONS AND ARE MEASURED AT THE PARTING LINE. MOLD FLASH OR PROTRUSIONS SHALL NOT EXCEED 0.15 (0.006) PER SIDE.
4. TERMINAL NUMBERS ARE SHOWN FOR REFERENCE ONLY.
5. THE LEAD WIDTH DIMENSION (b) DOES NOT INCLUDE DAMBAR PROTRUSION. ALLOWABLE DAMBAR PROTRUSION SHALL BE 0.08 (0.003) TOTAL IN EXCESS OF THE LEAD WIDTH DIMENSION AT MAXIMUM MATERIAL CONDITION. DAMBAR CANNOT BE LOCATED ON THE LOWER RADIUS OR THE FOOT. MINIMUM SPACE BETWEEN PROTRUSIONS AND ADJACENT LEAD TO BE 0.46 (0.018).

| DIM            | MILLIMETERS |       | INCHES    |       |
|----------------|-------------|-------|-----------|-------|
|                | MIN         | MAX   | MIN       | MAX   |
| A              | ---         | 2.05  | ---       | 0.081 |
| A <sub>1</sub> | 0.05        | 0.20  | 0.002     | 0.008 |
| b              | 0.35        | 0.50  | 0.014     | 0.020 |
| c              | 0.15        | 0.25  | 0.006     | 0.010 |
| D              | 12.35       | 12.80 | 0.486     | 0.504 |
| E              | 5.10        | 5.45  | 0.201     | 0.215 |
| e              | 1.27 BSC    |       | 0.050 BSC |       |
| H <sub>E</sub> | 7.40        | 8.20  | 0.291     | 0.323 |
| L              | 0.50        | 0.85  | 0.020     | 0.033 |
| L <sub>E</sub> | 1.10        | 1.50  | 0.043     | 0.059 |
| M              | 0°          | 10°   | 0°        | 10°   |
| Q <sub>1</sub> | 0.70        | 0.90  | 0.028     | 0.035 |
| Z              | ---         | 0.81  | ---       | 0.032 |

ON Semiconductor and are registered trademarks of Semiconductor Components Industries, LLC (SCILLC). SCILLC reserves the right to make changes without further notice to any products herein. SCILLC makes no warranty, representation or guarantee regarding the suitability of its products for any particular purpose, nor does SCILLC assume any liability arising out of the application or use of any product or circuit, and specifically disclaims any and all liability, including without limitation special, consequential or incidental damages. "Typical" parameters which may be provided in SCILLC data sheets and/or specifications can and do vary in different applications and actual performance may vary over time. All operating parameters, including "Typicals" must be validated for each customer application by customer's technical experts. SCILLC does not convey any license under its patent rights nor the rights of others. SCILLC products are not designed, intended, or authorized for use as components in systems intended for surgical implant into the body, or other applications intended to support or sustain life, or for any other application in which the failure of the SCILLC product could create a situation where personal injury or death may occur. Should Buyer purchase or use SCILLC products for any such unintended or unauthorized application, Buyer shall indemnify and hold SCILLC and its officers, employees, subsidiaries, affiliates, and distributors harmless against all claims, costs, damages, and expenses, and reasonable attorney fees arising out of, directly or indirectly, any claim of personal injury or death associated with such unintended or unauthorized use, even if such claim alleges that SCILLC was negligent regarding the design or manufacture of the part. SCILLC is an Equal Opportunity/Affirmative Action Employer. This literature is subject to all applicable copyright laws and is not for resale in any manner.

### PUBLICATION ORDERING INFORMATION

**LITERATURE FULFILLMENT:**  
Literature Distribution Center for ON Semiconductor  
P.O. Box 5163, Denver, Colorado 80217 USA  
**Phone:** 303-675-2175 or 800-344-3860 Toll Free USA/Canada  
**Fax:** 303-675-2176 or 800-344-3867 Toll Free USA/Canada  
**Email:** orderlit@onsemi.com

**N. American Technical Support:** 800-282-9855 Toll Free  
USA/Canada  
**Europe, Middle East and Africa Technical Support:**  
Phone: 421 33 790 2910  
**Japan Customer Focus Center**  
Phone: 81-3-5773-3850

**ON Semiconductor Website:** [www.onsemi.com](http://www.onsemi.com)  
**Order Literature:** <http://www.onsemi.com/orderlit>

For additional information, please contact your local Sales Representative



## Стандарт Электрон Связь

Мы молодая и активно развивающаяся компания в области поставок электронных компонентов. Мы поставляем электронные компоненты отечественного и импортного производства напрямую от производителей и с крупнейших складов мира.

Благодаря сотрудничеству с мировыми поставщиками мы осуществляем комплексные и плановые поставки широчайшего спектра электронных компонентов.

Собственная эффективная логистика и склад в обеспечивает надежную поставку продукции в точно указанные сроки по всей России.

Мы осуществляем техническую поддержку нашим клиентам и предпродажную проверку качества продукции. На все поставляемые продукты мы предоставляем гарантию .

Осуществляем поставки продукции под контролем ВП МО РФ на предприятия военно-промышленного комплекса России , а также работаем в рамках 275 ФЗ с открытием отдельных счетов в уполномоченном банке. Система менеджмента качества компании соответствует требованиям ГОСТ ISO 9001.

Минимальные сроки поставки, гибкие цены, неограниченный ассортимент и индивидуальный подход к клиентам являются основой для выстраивания долгосрочного и эффективного сотрудничества с предприятиями радиоэлектронной промышленности, предприятиями ВПК и научно-исследовательскими институтами России.

С нами вы становитесь еще успешнее!

### Наши контакты:

**Телефон:** +7 812 627 14 35

**Электронная почта:** [sales@st-electron.ru](mailto:sales@st-electron.ru)

**Адрес:** 198099, Санкт-Петербург,  
Промышленная ул, дом № 19, литера Н,  
помещение 100-Н Офис 331