

MMPQ6700

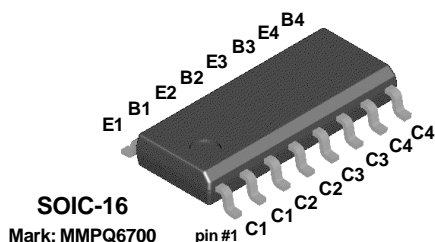

TRANSISTOR TYPE							
C1	B1	E1	&	C2	B2	E2	NPN
C3	B3	E3	&	C4	B4	E4	PNP

Quad NPN & PNP General Purpose Amplifier

These complementary devices can be used in switches with collector currents of 10 μ A to 100 mA. These devices are best used when space is the primary consideration. Sourced from Process 23 & 66. See 2N3904 (NPN) & 2N3906 (PNP) for characteristics.

Absolute Maximum Ratings*

TA = 25°C unless otherwise noted

Symbol	Parameter	Value	Units
V _{CEO}	Collector-Emitter Voltage	40	V
V _{CBO}	Collector-Base Voltage	40	V
V _{EBO}	Emitter-Base Voltage	5.0	V
I _C	Collector Current - Continuous	200	mA
T _J , T _{stg}	Operating and Storage Junction Temperature Range	-55 to +150	°C

*These ratings are limiting values above which the serviceability of any semiconductor device may be impaired.

NOTES:

- 1) These ratings are based on a maximum junction temperature of 150 degrees C.
- 2) These are steady state limits. The factory should be consulted on applications involving pulsed or low duty cycle operations.
- 3) All voltages (V) and currents (A) are negative polarity for PNP transistors.

Thermal Characteristics

TA = 25°C unless otherwise noted

Symbol	Characteristic	Max	Units
		MMPQ6700	
P _D	Total Device Dissipation Derate above 25°C	1000	mW
		8.0	mW/°C
R _{θJA}	Thermal Resistance, Junction to Ambient Effective 4 Die Each Die	125	°C/W
		240	°C/W

Quad NPN & PNP General Purpose Amplifier (continued)

MMMPQ6700

Electrical Characteristics

TA = 25°C unless otherwise noted

Symbol	Parameter	Test Conditions	Min	Max	Units
--------	-----------	-----------------	-----	-----	-------

OFF CHARACTERISTICS

$V_{(BR)CEO}$	Collector-Emitter Breakdown Voltage*	$I_C = 10 \text{ mA}, I_B = 0$	40		V
$V_{(BR)CBO}$	Collector-Base Breakdown Voltage	$I_C = 10 \text{ }\mu\text{A}, I_E = 0$	40		V
$V_{(BR)EBO}$	Emitter-Base Breakdown Voltage	$I_E = 10 \text{ }\mu\text{A}, I_C = 0$	5.0		V
I_{CBO}	Collector-Cutoff Current	$V_{CB} = 30 \text{ V}, I_E = 0$		50	nA
I_{EBO}	Emitter-Cutoff Current	$V_{EB} = 4.0 \text{ V}, I_C = 0$		50	nA

ON CHARACTERISTICS*

h_{FE}	DC Current Gain	$V_{CE} = 1.0 \text{ V}, I_C = 0.1 \text{ mA}$ $V_{CE} = 1.0 \text{ V}, I_C = 1.0 \text{ mA}$ $V_{CE} = 1.0 \text{ V}, I_C = 10 \text{ mA}$	30 50 70		
$V_{CE(sat)}$	Collector-Emitter Saturation Voltage	$I_C = 10 \text{ mA}, I_B = 1.0 \text{ mA}$		0.25	V
$V_{BE(sat)}$	Base-Emitter Saturation Voltage	$I_C = 10 \text{ mA}, I_B = 1.0 \text{ mA}$		0.90	V

SMALL SIGNAL CHARACTERISTICS

C_{ob}	Output Capacitance	$V_{CB} = 5.0 \text{ V}, f = 100 \text{ kHz}$		4.5	pF
C_{ib}	Input Capacitance	$V_{BE} = 0.5 \text{ V}, f = 100 \text{ kHz}$ PNP $V_{BE} = 0.5 \text{ V}, f = 100 \text{ kHz}$ NPN		10 8.0	pF pF
f_T	Current-Gain Bandwidth Product	$I_C = 10 \text{ mA}, V_{CE} = 20 \text{ V}, f = 100 \text{ MHz}$	200		MHz

*Pulse Test: Pulse Width $\leq 300 \text{ }\mu\text{s}$, Duty Cycle $\leq 2.0\%$

SOIC-16 Tape and Reel Data



SOIC(16lds) Packaging Configuration: Figure 1.0

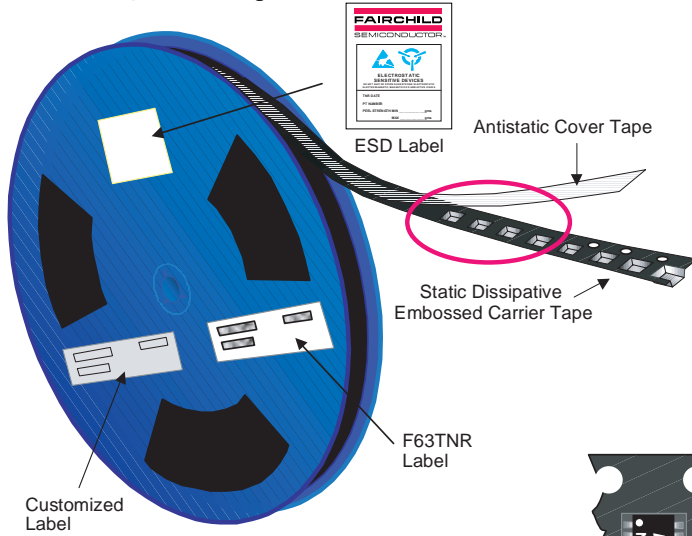

Packaging Description:
 SOIC-16 parts are shipped in tape. The carrier tape is made from a dissipative (carbon filled) polycarbonate resin. The cover tape is a multilayer film (Heat Activated Adhesive in nature) primarily composed of polyester film, adhesive layer, sealant, and anti-static sprayed agent. These reeled parts in standard option are shipped with 2,500 units per 13" or 330cm diameter reel. The reels are dark blue in color and is made of polystyrene plastic (anti-static coated). This and some other options are further described in the Packaging Information table.
 These full reels are individually barcode labeled and placed inside a standard intermediate box (illustrated in figure 1.0) made of recyclable corrugated brown paper. One box contains two reels maximum. And these boxes are placed inside a barcode labeled shipping box which comes in different sizes depending on the number of parts shipped.

SOIC (16lds) Packaging Information		
Packaging Option	Standard (no flow code)	L86Z
Packaging type	TNR	Rail/Tube
Qty per Reel/Tube/Bag	2,500	45
Reel Size	13" Dia	-
Box Dimension (mm)	343x64x343	530x130x83
Max qty per Box	5,000	13,500
Weight per unit (gm)	0.1437	0.1437
Weight per Reel (kg)	0.7735	-
Note/Comments		

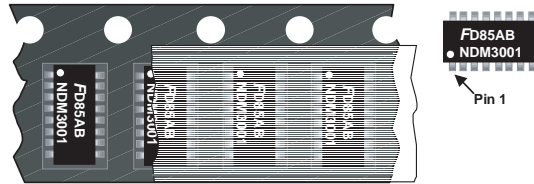

SOIC-16 Unit Orientation

F63TNR Label sample

LOT: CBVK741B019	QTY: 2500	
FSID: NDM3000	SPEC:	
D/C1: D9842	QTY1:	SPEC REV:
D/C2:	QTY2:	CPN:
		N/F: F (F63TNR)3

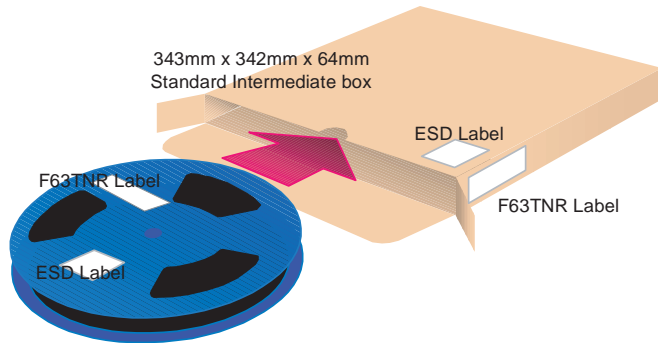

SOIC(16lds) Tape Leader and Trailer Configuration: Figure 2.0

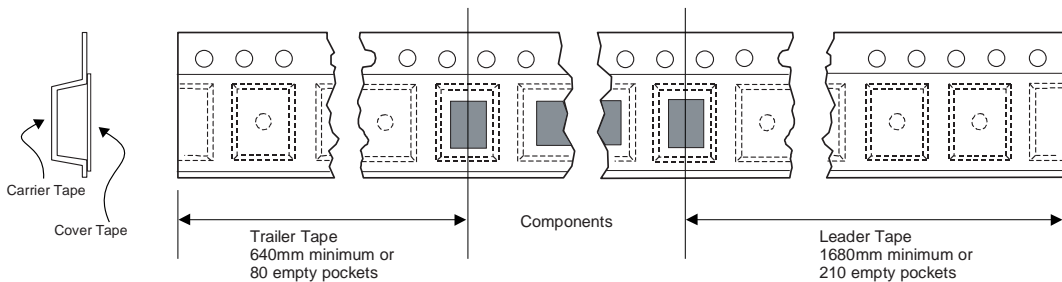

SOIC-16 Tape and Reel Data, continued

SOIC(16lds) Embossed Carrier Tape Configuration: Figure 3.0

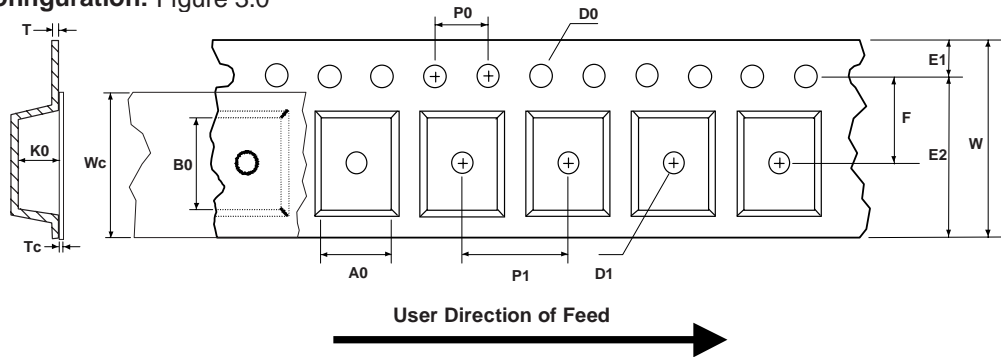

Dimensions are in millimeter														
Pkg type	A0	B0	W	D0	D1	E1	E2	F	P1	P0	K0	T	Wc	Tc
SOIC(16lds) (16mm)	6.60 +/-0.30	10.35 +/-0.25	16.0 +/-0.3	1.55 +/-0.05	1.60 +/-0.10	1.75 +/-0.10	14.25 min	7.50 +/-0.05	8.0 +/-0.1	4.0 +/-0.1	2.40 +/-0.40	0.450 +/-0.150	13.0 +/-0.3	0.06 +/-0.02

Notes: A0, B0, and K0 dimensions are determined with respect to the EIA/Jedec RS-481 rotational and lateral movement requirements (see sketches A, B, and C).

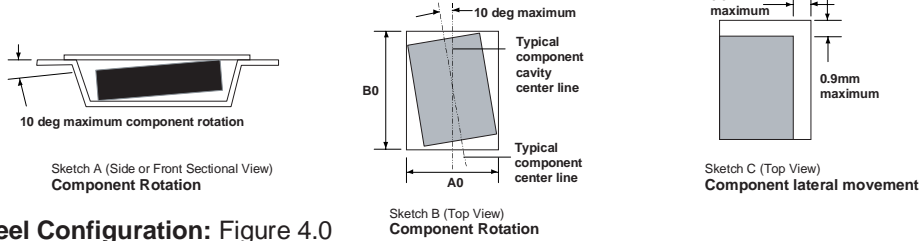

SOIC(16lds) Reel Configuration: Figure 4.0

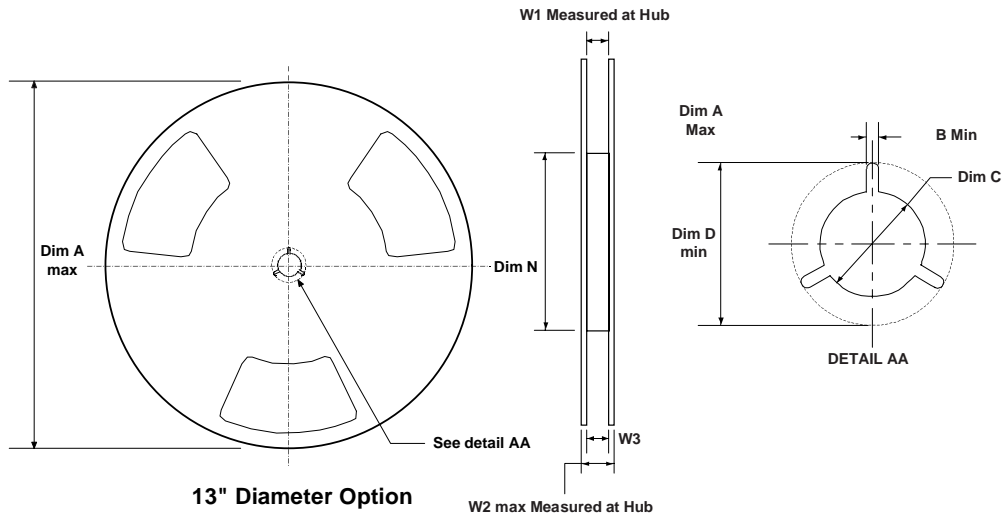

Dimensions are in inches and millimeters									
Tape Size	Reel Option	Dim A	Dim B	Dim C	Dim D	Dim N	Dim W1	Dim W2	Dim W3 (LSL-USL)
16mm	13" Dia	13.00 330	0.059 1.5	512 +0.020/-0.008 13 +0.5/-0.2	0.795 20.2	4.00 100	0.646 +0.078/-0.000 16.4 +2/0	0.882 22.4	0.626 - 0.764 15.9 - 19.4

SOIC-16 Package Dimensions



SOIC-16 (FS PKG Code S3)

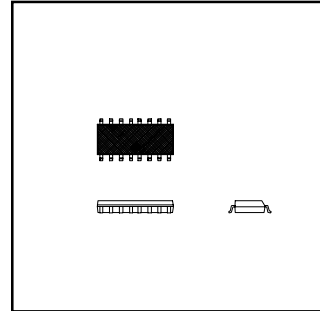
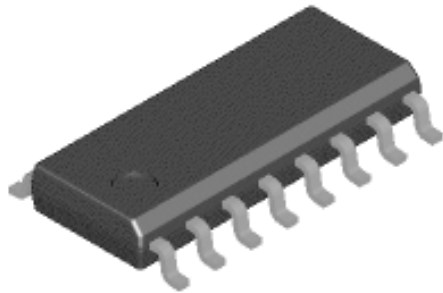

1:1

Scale 1:1 on letter size paper

Dimensions shown below are in:
inches [millimeters]

Part Weight per unit (gram): 0.1437

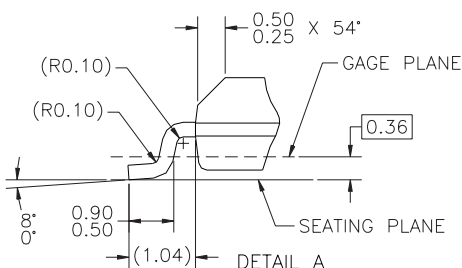
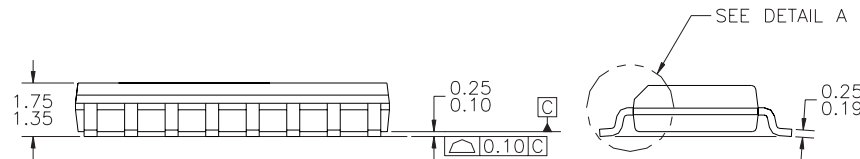
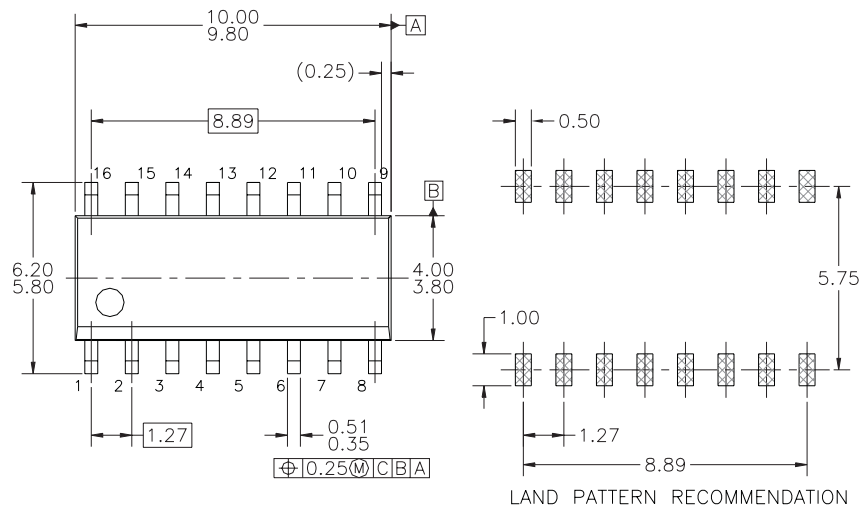

NOTES: UNLESS OTHERWISE SPECIFIED

- A) THIS PACKAGE CONFORMS TO JEDEC MS-012, VARIATION AC, ISSUE C, DATED MAY 1990.
- B) ALL DIMENSIONS ARE IN MILLIMETERS.
- C) STANDARD LEAD FINISH:
200 MICRONS / 5.08 MICRONS MIN.
LEAD/TIN (SOLDER) ON COPPER.

TRADEMARKS

The following are registered and unregistered trademarks Fairchild Semiconductor owns or is authorized to use and is not intended to be an exhaustive list of all such trademarks.

ACE ^x TM	FAST ^r TM	PowerTrench [®]	SyncFET TM
Bottomless TM	GlobalOptoisolator TM	QFET TM	TinyLogic TM
CoolFET TM	GTO TM	QS TM	UHC TM
CROSSVOLT TM	HiSeC TM	QT Optoelectronics TM	VCX TM
DOME TM	ISOPLANAR TM	Quiet Series TM	
E ² CMOS TM	MICROWIRE TM	SILENT SWITCHER [®]	
EnSigna TM	OPTOLOGIC TM	SMART START TM	
FACT TM	OPTOPLANAR TM	SuperSOT TM -3	
FACT Quiet Series TM	PACMAN TM	SuperSOT TM -6	
FAST [®]	POP TM	SuperSOT TM -8	

DISCLAIMER

FAIRCHILD SEMICONDUCTOR RESERVES THE RIGHT TO MAKE CHANGES WITHOUT FURTHER NOTICE TO ANY PRODUCTS HEREIN TO IMPROVE RELIABILITY, FUNCTION OR DESIGN. FAIRCHILD DOES NOT ASSUME ANY LIABILITY ARISING OUT OF THE APPLICATION OR USE OF ANY PRODUCT OR CIRCUIT DESCRIBED HEREIN; NEITHER DOES IT CONVEY ANY LICENSE UNDER ITS PATENT RIGHTS, NOR THE RIGHTS OF OTHERS.

LIFE SUPPORT POLICY

FAIRCHILD'S PRODUCTS ARE NOT AUTHORIZED FOR USE AS CRITICAL COMPONENTS IN LIFE SUPPORT DEVICES OR SYSTEMS WITHOUT THE EXPRESS WRITTEN APPROVAL OF FAIRCHILD SEMICONDUCTOR CORPORATION. As used herein:

1. Life support devices or systems are devices or systems which, (a) are intended for surgical implant into the body, or (b) support or sustain life, or (c) whose failure to perform when properly used in accordance with instructions for use provided in the labeling, can be reasonably expected to result in significant injury to the user.
2. A critical component is any component of a life support device or system whose failure to perform can be reasonably expected to cause the failure of the life support device or system, or to affect its safety or effectiveness.

PRODUCT STATUS DEFINITIONS

Definition of Terms

Datasheet Identification	Product Status	Definition
Advance Information	Formative or In Design	This datasheet contains the design specifications for product development. Specifications may change in any manner without notice.
Preliminary	First Production	This datasheet contains preliminary data, and supplementary data will be published at a later date. Fairchild Semiconductor reserves the right to make changes at any time without notice in order to improve design.
No Identification Needed	Full Production	This datasheet contains final specifications. Fairchild Semiconductor reserves the right to make changes at any time without notice in order to improve design.
Obsolete	Not In Production	This datasheet contains specifications on a product that has been discontinued by Fairchild semiconductor. The datasheet is printed for reference information only.



Стандарт Электрон Связь

Мы молодая и активно развивающаяся компания в области поставок электронных компонентов. Мы поставляем электронные компоненты отечественного и импортного производства напрямую от производителей и с крупнейших складов мира.

Благодаря сотрудничеству с мировыми поставщиками мы осуществляем комплексные и плановые поставки широчайшего спектра электронных компонентов.

Собственная эффективная логистика и склад в обеспечивает надежную поставку продукции в точно указанные сроки по всей России.

Мы осуществляем техническую поддержку нашим клиентам и предпродажную проверку качества продукции. На все поставляемые продукты мы предоставляем гарантию .

Осуществляем поставки продукции под контролем ВП МО РФ на предприятия военно-промышленного комплекса России , а также работаем в рамках 275 ФЗ с открытием отдельных счетов в уполномоченном банке. Система менеджмента качества компании соответствует требованиям ГОСТ ISO 9001.

Минимальные сроки поставки, гибкие цены, неограниченный ассортимент и индивидуальный подход к клиентам являются основой для выстраивания долгосрочного и эффективного сотрудничества с предприятиями радиоэлектронной промышленности, предприятиями ВПК и научно-исследовательскими институтами России.

С нами вы становитесь еще успешнее!

Наши контакты:

Телефон: +7 812 627 14 35

Электронная почта: sales@st-electron.ru

Адрес: 198099, Санкт-Петербург,
Промышленная ул, дом № 19, литера Н,
помещение 100-Н Офис 331