

Table of Contents

Z-PACK TinMan High Speed, High Density Backplane Connector 5-48

Introduction 6-8

6 Pair Right Angle Receptacle Assemblies 9

5 Pair Right Angle Receptacle Assemblies 10

4 Pair Right Angle Receptacle Assemblies 11

3 Pair Right Angle Receptacle Assemblies 12

4 Pair Vertical Receptacle Assemblies 13

6 Pair Vertical Header Assemblies 14

6 Pair Vertical Header Assemblies — Left End Wall 15

6 Pair Vertical Header Assemblies — Right End Wall 16

6 Pair Vertical Header Assemblies — Double End Walls 17

5 Pair Vertical Header Assemblies 18

5 Pair Vertical Header Assemblies — Left End Wall 19

5 Pair Vertical Header Assemblies — Right End Wall 20

5 Pair Vertical Header Assemblies — Double End Walls 21

4 Pair Vertical Header Assemblies 22

4 Pair Vertical Header Assemblies — Left End Wall 23

4 Pair Vertical Header Assemblies — Right End Wall 24

4 Pair Vertical Header Assemblies — Double End Walls 25

3 Pair Vertical Header Assemblies 26

3 Pair Vertical Header Assemblies — Left End Wall 27

3 Pair Vertical Header Assemblies — Right End Wall 28

3 Pair Vertical Header Assemblies — Double End Walls 29

5 Pair Right Angle Pin Header Assemblies 30

5 Pair Right Angle Pin Header Assemblies — Double End Walls 31

4 Pair Right Angle Pin Header Assemblies 32

4 Pair Right Angle Pin Header Assemblies — Double End Walls 33

3 Pair Right Angle Pin Header Assemblies 34

3 Pair Right Angle Pin Header Assemblies — Double End Walls 35

Z-PACK TinMan Midplane (Orthogonal) Connector Overview 36-38

6 Pair Midplane Assemblies 39-45

Z-PACK TinMan Product Mating Sequence Chart 46

Introduction

Product Facts

- 10+ Gbps performance
- 100 ohm Impedance for Differential Pair configuration
- 5 pair version offers 26 pairs/10mm [66 differential pairs/inch] fitting within a 25.40 [1.00] card slot pitch
- 4 pair version offers 21 pairs/10mm [53 differential pairs/inch] fitting within a 20.30 [.800] card slot pitch
- 3 pair version offering 16 pairs/10mm [40 differential pairs/inch] fitting within a 16.25 [.625] card slot pitch
- Right angle pin headers (coplanar) in 3 pair, 4 pair, and 5 pair versions
- Reliable, redundant contact design on every signal contact
- Modular system offered in various column versions
- Meets Industry reliability requirements of Bellcore/Telcordia
- Sequencing for ground and signal contacts
- RoHS Compliant

Future Product Extensions

- Vertical receptacles
- High speed cable assemblies and hardware

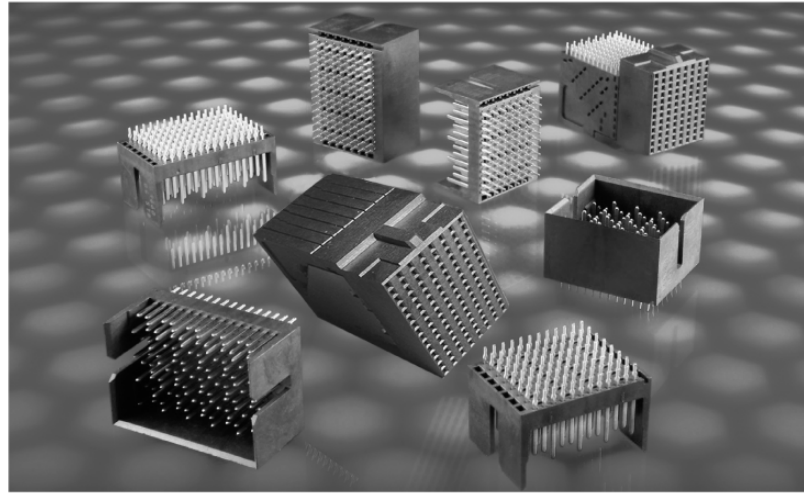

The Z-PACK TinMan backplane connector family is a cost-effective solution for customers searching for a high density, high performance backplane interconnect system.

The Z-PACK TinMan connector design follows proven industry backplane convention by offering a fully protected right-angle receptacle for use on daughter-cards where handling damage can be a concern when mating to a vertical male header. This connector permits field repairability at either the module or single pin levels.

Ground contacts positioned within each column of the connector, combined with unique contact lead frame arrangements, enable the Z-PACK TinMan connector to achieve low crosstalk and high through-put performance levels. Reliability is provided with a dual point of contact mating interface and compliant pin interface to the printed circuit board.

Industry Applications

Ideally designed for cost pressured, high signal density applications requiring interconnection between two printed circuit boards, such as those typically found in server, storage, switch, router, and similar applications. The Z-PACK TinMan connector product family is suited to meet the demands of today's modular system designs by offering a variety of configurations. The product family includes configurations to fit 20.32 [.800] and 25.40 [1.00] card slot spacing.

Technical Documents

- Product Specification** 108-2303
- Application Specification** 114-13202
- Routing Guide Report** #27GC001-1

Material and Finish

- Signal Contact** — High Strength Copper Alloy
- Ground Contact** — High Strength Copper Alloy
- Housing** — Liquid Crystal Polymer, UL 94V-0 Rated
- Platings** — Telcordia compliant interface, Nickel underplate
- Compliant Pin Plating** — RoHS Compliant

Ratings

- Temperature Range** — -65°C to +90°C
- Current Rating** — 0.5 A/contact @ < 30°C T-Rise
- Durability** — 200 cycles
- Dielectric Withstanding Voltage** — 560 VAC
- Operating Voltage** — 250 VAC max.

Signal Integrity

- Characteristic Impedance** — Differential @ 100 ohms ±10%
- Crosstalk** — Multi-pair differential crosstalk: 2.1% @ 50ps
- Insertion Loss** — -2 dB @ 10 GHz

TELCORDIA is a trademark of Telcordia Technologies, Inc.

For additional information visit:
<http://www.tycoelectronics.com/zpacktinman>

Introduction (Continued)

Noise Table

- Maximum, multiple source crosstalk

| Victim Pair | Total Peak Receiver Noise for Recommended Pin-Out |
|-------------|---|
| AB9 | 0.8% |
| BC8 | 1.6% |
| DE9 | 1.9% |
| EF8 | 1.9% |
| GH9 | 2.0% |
| HI8 | 2.0% |
| JG9 | 2.0% |
| KL8 | 2.1% |
| MN9 | 1.7% |
| NO8 | 0.8% |

Note: Data includes PCB vias of both backplane and daughtercard connectors. Single mated connector pair 50 ps (20-80%) edge rate

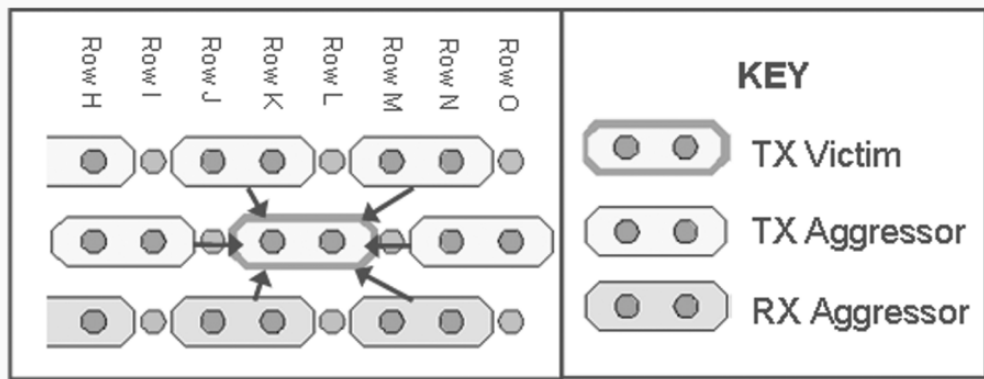

Insertion Loss Plot

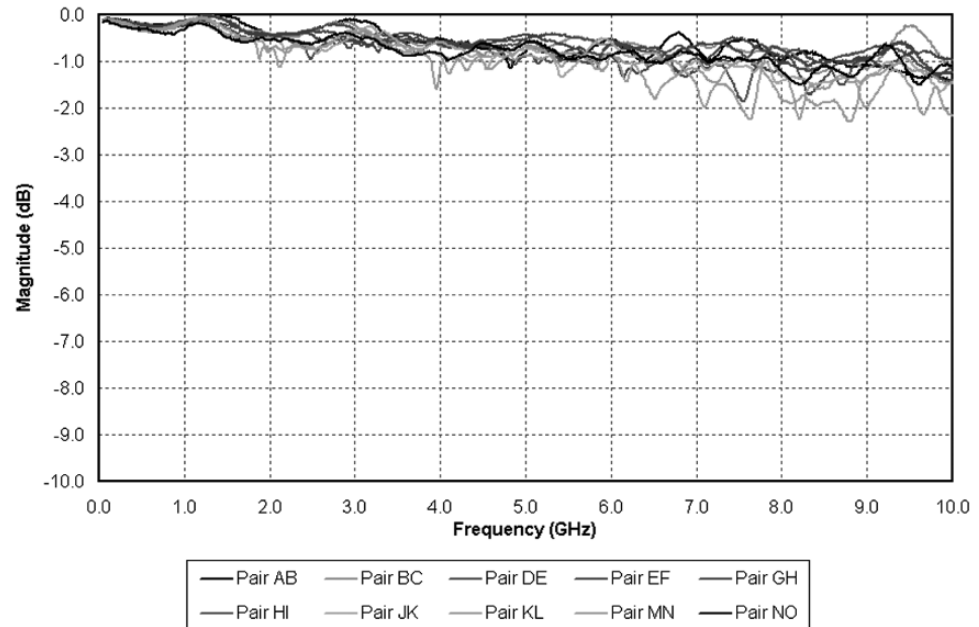

Introduction (Continued)

Representative Eye Pattern

- 10.0 Gbps data rate
- 2⁷-1 PRBS
- Unequalized Signal

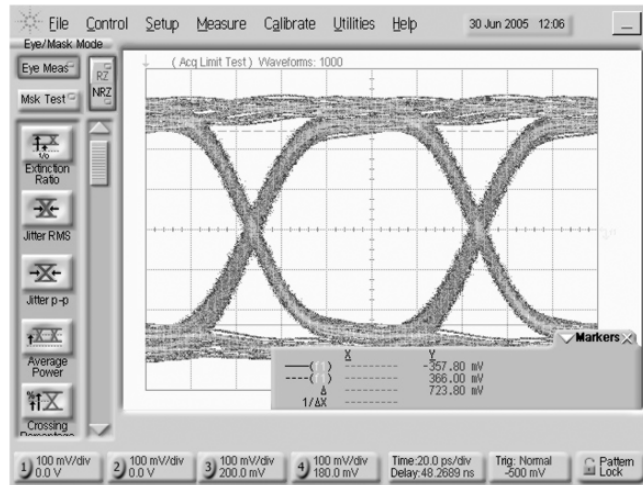

Customer Connector Evaluation Kit

- Connector characterization
- Available for loan — contact your local Tyco Electronics Sales Engineer
- Time and frequency domain testable
- Testable to 18+ GHz (25+ Gb/s)
- Multiple calibration options
- Convenient SMA interface

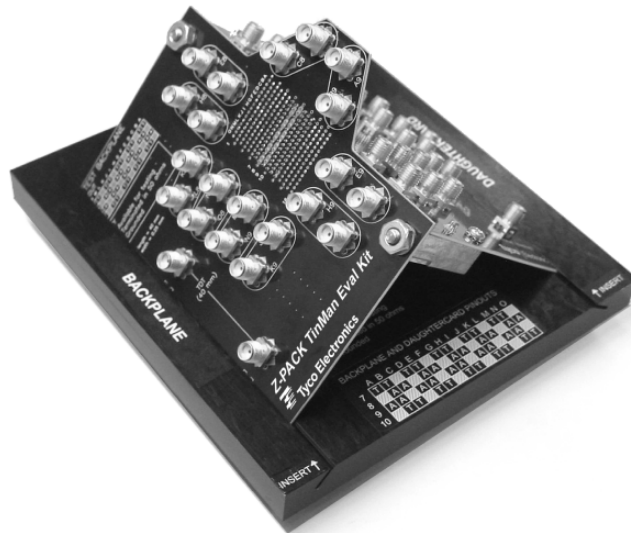

Customer System Evaluation Kit

- System characterization
- Available for loan — contact your local Tyco Electronics Sales Engineer
- Time and frequency domain testable
- Testable to 18+ GHz (25+ Gb/s)
- Multiple system lengths
- Convenient SMA interface

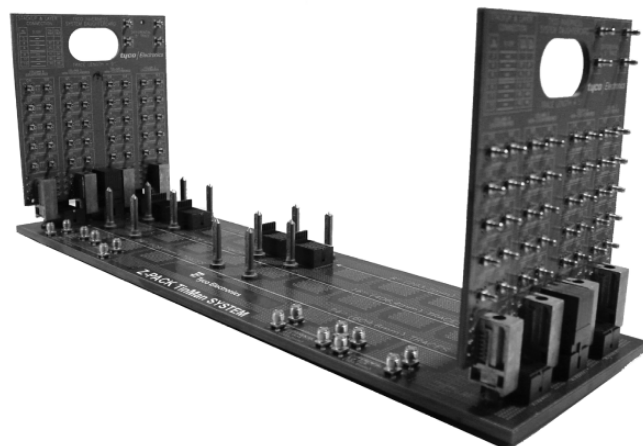

6 Pair Right Angle Receptacle Assemblies

| Column | Part Number | Dimension | | Application Tooling | Mates With |
|--------|-------------|----------------|----------------|---------------------|---|
| | | A | B | | |
| 8 | 1934504-1 | 15.35 .604 | 13.30 .524 | * | 1934505-1, 1934513-1, 1934514-1, 1934515-1 |
| 10 | 2065021-1 | 19.15 .754 | 17.10 .673 | * | 1934520-1, 1934523-1 |
| 16 | 1934912-1 | 30.55 1.203 | 28.50 1.122 | * | 1934516-1, 1934519-1 |

* Custom tooling not required. Utilizes flat-rock insertion tooling. Reference Application Specification 114-13202.

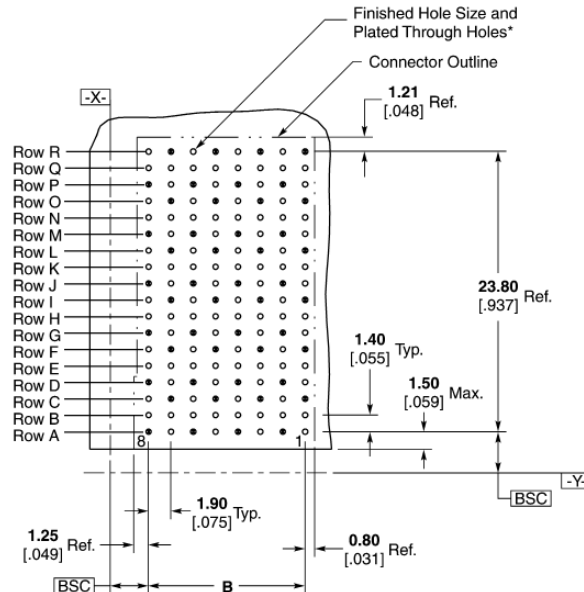
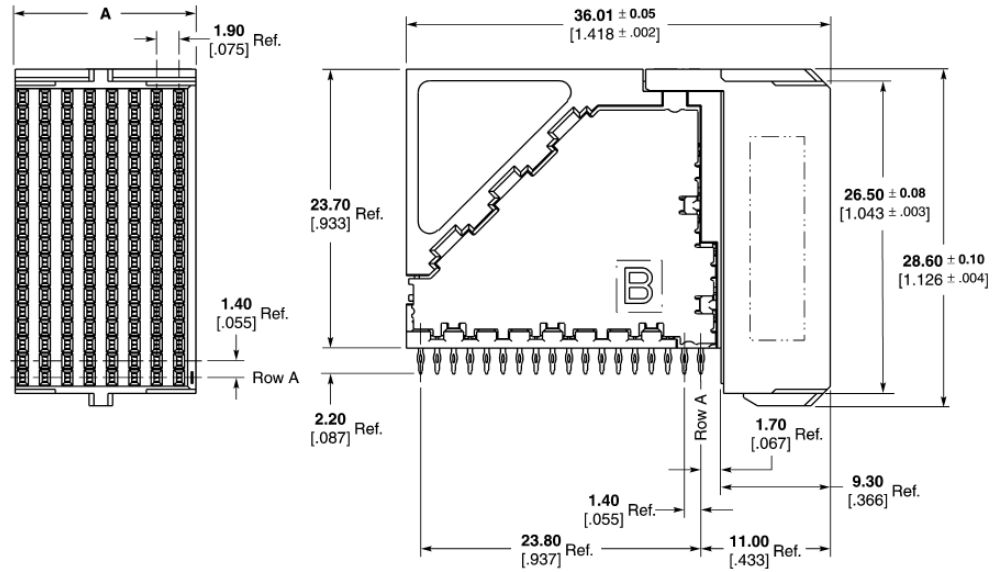

**Recommended PC Board Layout
Daughterboard
Component Side Shown**

Note: For additional information on pcb routing guidelines, reference the Z-PACK TinMan Connector Routing Guide Report #27GC001-1.

* Finished Hole Diameter = 0.46 ± 0.05 [0.018 ± .002]
Drilled Hole Diameter = 0.55 ± 0.02 [0.022 ± .001]
Copper Thickness = 0.038 ± 0.013 [0.0015 ± .0005]
Tin-Lead Thickness = 0.008 ± 0.004 [0.0003 ± .0002]
Finishes other than Tin-Lead, See Appl. Spec. 114-13202

Note: All part numbers are RoHS compliant. Tin-Lead parts are RoHS compliant through exemption for lead in press-fit connectors.

5 Pair Right Angle Receptacle Assemblies

| Column | Part Number | Dimension | | Application Tooling | Mates With |
|--------|-------------|----------------|----------------|---------------------|---|
| | | A | B | | |
| 8 | 1934218-1 | 15.35 .604 | 13.30 .524 | * | 1934269-1,(R) 1934272-1,(L) 1934273-1, 1934271-1, 1934349-1, 1934350-1 |
| 10 | 1934220-1 | 19.15 .754 | 17.10 .673 | * | 1934325-1, 1934326-1 |
| 16 | 1934221-1 | 30.55 1.203 | 28.50 1.122 | * | 1934331-1, 1934334-1, 1934333-1, 1934332-1, 1934347-1, 1934348-1 |

* Custom tooling not required. Utilizes flat-rock insertion tooling. Reference Application Specification 114-13202.

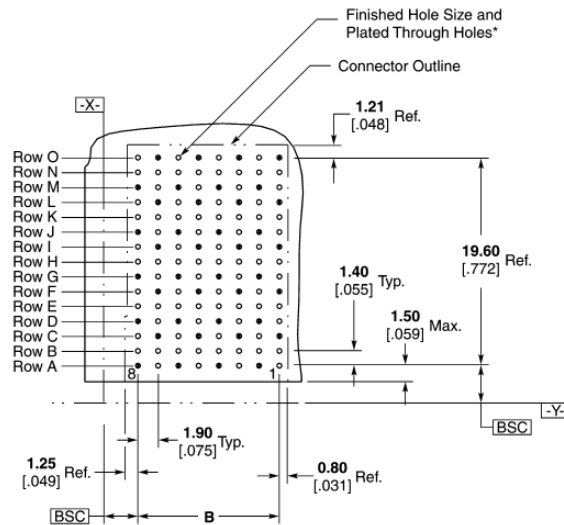
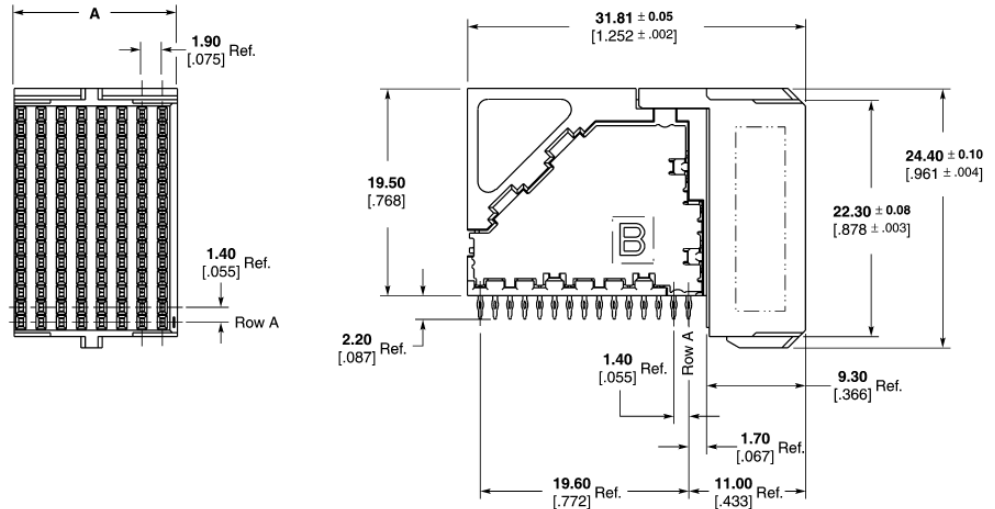

**Recommended PC Board Layout
Daughterboard
Component Side Shown**

Note: For additional information on pcb routing guidelines, reference the Z-PACK TinMan Connector Routing Guide Report #27GC001-1.

* Finished Hole Diameter = 0.46 ± 0.05 [0.018 ± .002]
 Drilled Hole Diameter = 0.55 ± 0.02 [0.022 ± .001]
 Copper Thickness = 0.038 ± 0.013 [0.0015 ± .0005]
 Tin-Lead Thickness = 0.008 ± 0.004 [0.0003 ± .0002]
 Finishes other than Tin-Lead, See Appl. Spec. 114-13202

Note: All part numbers are RoHS compliant. Tin-Lead parts are RoHS compliant through exemption for lead in press-fit connectors.

4 Pair Right Angle Receptacle Assemblies

| Column | Part Number | Dimension | | Application Tooling | Mates With |
|--------|-------------|----------------|----------------|---------------------|---|
| | | A | B | | |
| 8 | 1934222-1 | 15.35 .604 | 13.30 .524 | * | 1934304-1, 1934303-1, 1934305-1, 1934306-1, 1934353-1, 1934354-1 |
| 10 | 1934224-1 | 19.15 .754 | 17.10 .673 | * | 1934311-1, 1934312-1, 1934313-1, 1934314-1 |
| 16 | 1934225-1 | 30.55 1.203 | 28.50 1.122 | * | 1934315-1, 1934318-1, 1934317-1, 1934316-1, 1934351-1, 1934352-1 |

* Custom tooling not required. Utilizes flat-rock insertion tooling. Reference Application Specification 114-13202.

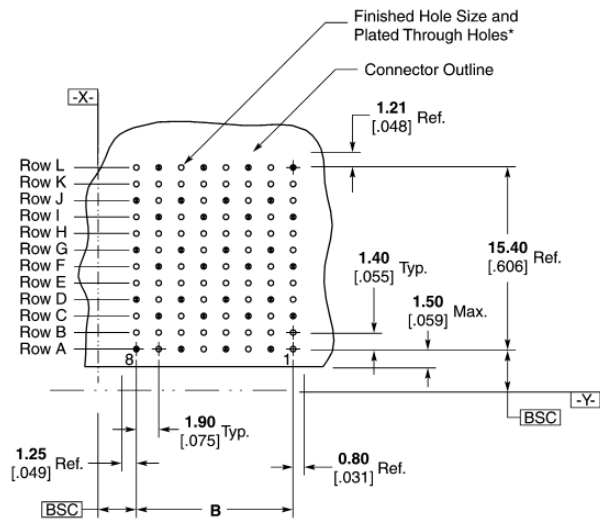
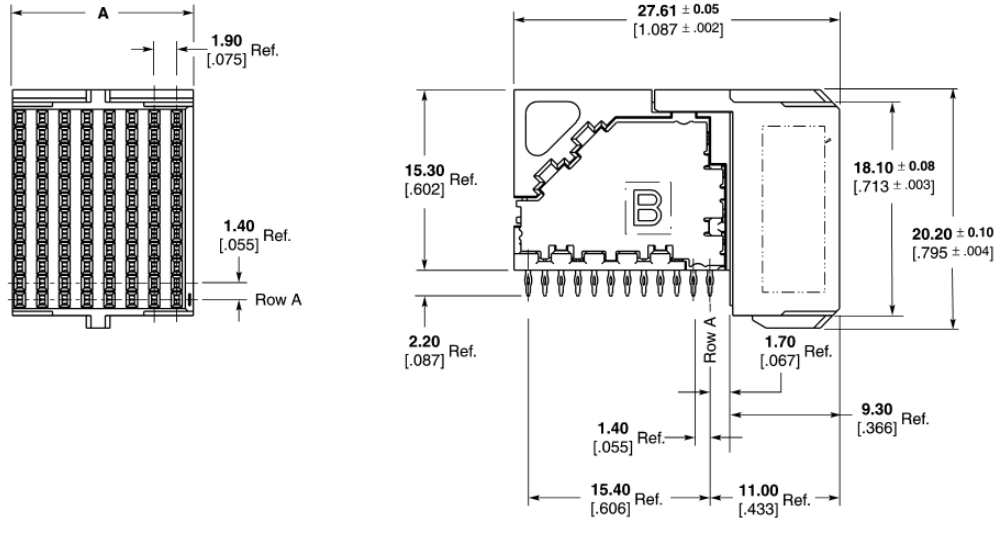

**Recommended PC Board Layout
Daughterboard
Component Side Shown**

Note: For additional information on pcb routing guidelines, reference the Z-PACK TinMan Connector Routing Guide Report #27GC001-1.

* Finished Hole Diameter = 0.46 ± 0.05 [0.018 ± 0.002]
 Drilled Hole Diameter = 0.55 ± 0.02 [0.022 ± 0.001]
 Copper Thickness = 0.038 ± 0.013 [0.0015 ± 0.0005]
 Tin-Lead Thickness = 0.008 ± 0.004 [0.0003 ± 0.0002]
 Finishes other than Tin-Lead, See Appl. Spec. 114-13202

Note: All part numbers are RoHS compliant. Tin-Lead parts are RoHS compliant through exemption for lead in press-fit connectors.

3 Pair Right Angle Receptacle Assemblies

| Column | Part Number | Dimension | | Application Tooling | Mates With |
|--------|-------------|----------------|----------------|---------------------|---|
| | | A | B | | |
| 8 | 1934226-1 | 15.35 .604 | 13.30 .524 | * | 1934299-1, 1934300-1, 1934301-1, 1934302-1, 1934359-1, 1934360-1 |
| 10 | 1934228-1 | 19.15 .754 | 17.10 .673 | * | 1934339-1, 1934341-1, 1934340-1, 1934342-1, 1934357-1, 1934358-1 |
| 16 | 1934229-1 | 30.55 1.203 | 28.50 1.122 | * | 1934343-1, 1934344-1, 1934345-1, 1934346-1, 1934355-1, 1934356-1 |

* Custom tooling not required. Utilizes flat-rock insertion tooling. Reference Application Specification 114-13202.

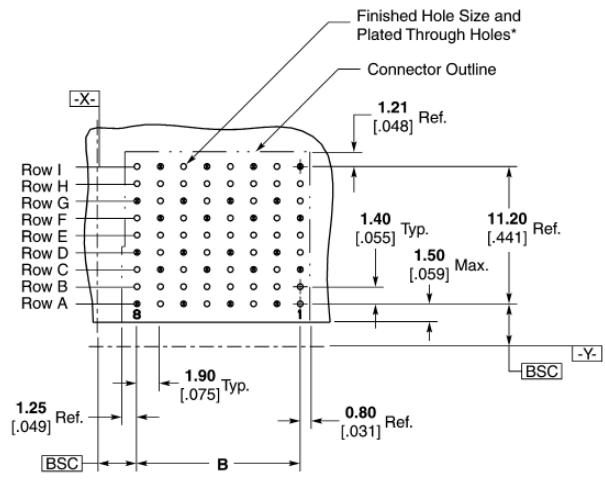
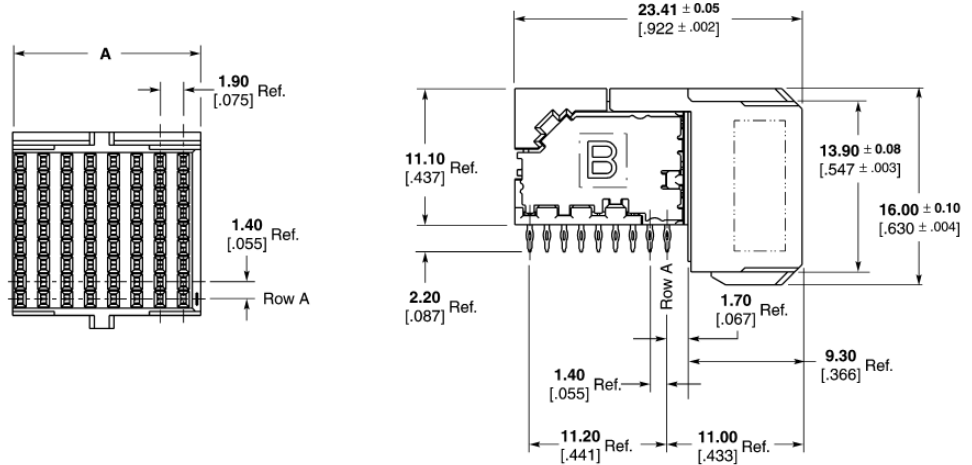

**Recommended PC Board Layout
Daughterboard
Component Side Shown**

Note: For additional information on pcb routing guidelines, reference the Z-PACK TinMan Connector Routing Guide Report #27GC001-1.

* Finished Hole Diameter = 0.46 ± 0.05 [.018 ± .002]
 Drilled Hole Diameter = 0.55 ± 0.02 [.022 ± .001]
 Copper Thickness = 0.038 ± 0.013 [.0015 ± .0005]
 Tin-Lead Thickness = 0.008 ± 0.004 [.0003 ± .0002]
 Finishes other than Tin-Lead, See Appl. Spec. 114-13202

Note: All part numbers are RoHS compliant. Tin-Lead parts are RoHS compliant through exemption for lead in press-fit connectors.

4 Pair Vertical Receptacle Assemblies

| Column | Part Number | Dimension | | Application Tooling | Mates With |
|--------|-------------|----------------|----------------|---------------------|---|
| | | A | B | | |
| 8 | 1934593-1 | 15.35 .605 | 13.30 .524 | * | 1934305-1, 1934303-1, 1934304-1, 1934306-1, 1934353-1, 1934354-1 |
| 10 | 1934544-1 | 19.15 .754 | 17.10 .673 | * | 1934311-1, 1934313-1, 1934314-1, 1934312-1 |
| 16 | 1934594-1 | 30.70 1.210 | 28.50 1.122 | * | 1934315-1, 1934317-1, 1934318-1, 1934316-1, 1934351-1, 1934352-1 |

* Custom tooling not required. Utilizes flat-rock insertion tooling. Reference Application Specification 114-13202.

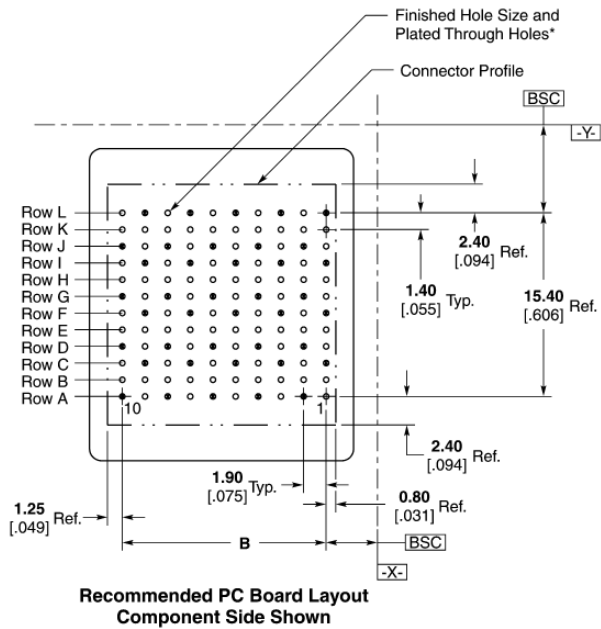
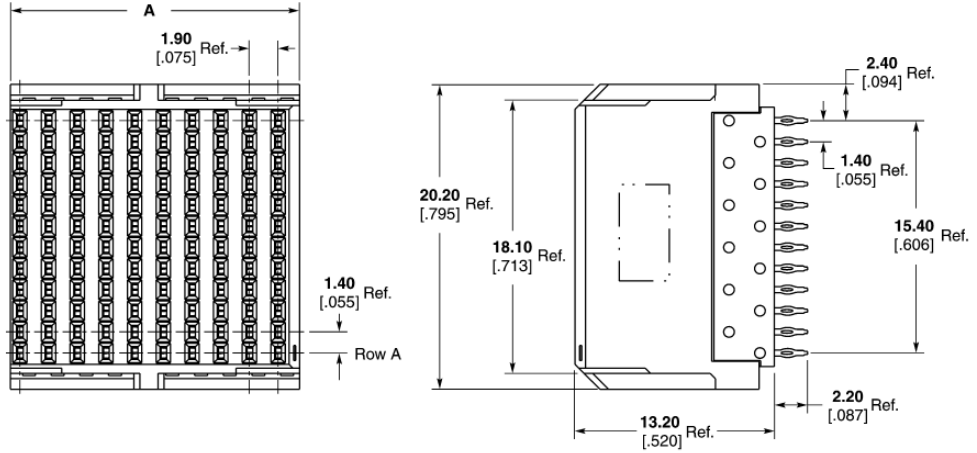

Note: For additional information on pcb routing guidelines, reference the Z-PACK TinMan Connector Routing Guide Report #27GC001-1.

* Finished Hole Diameter = 0.46 ± 0.05 [0.018 ± 0.002]
 Drilled Hole Diameter = 0.55 ± 0.02 [0.022 ± 0.001]
 Copper Thickness = 0.038 ± 0.013 [0.0015 ± 0.0005]
 Tin-Lead Thickness = 0.008 ± 0.004 [0.0003 ± 0.0002]
 Finishes other than Tin-Lead, See Appl. Spec. 114-13202

Note: All part numbers are RoHS compliant. Tin-Lead parts are RoHS compliant through exemption for lead in press-fit connectors.

6 Pair Vertical Header Assemblies

| Column | Part Number | Dimension | | Application Tooling | Mates With |
|--------|-------------|----------------|----------------|---------------------|------------|
| | | A | B | | |
| 8 | 1934505-1 | 15.35 .604 | 13.30 .524 | 2063383-1 | 1934504-1 |
| 10 | 1934520-1 | 19.15 .754 | 17.10 .673 | 2063383-2 | 2065021-1 |
| 16 | 1934516-1 | 30.55 1.203 | 28.50 1.122 | 2063383-3 | 1934912-1 |

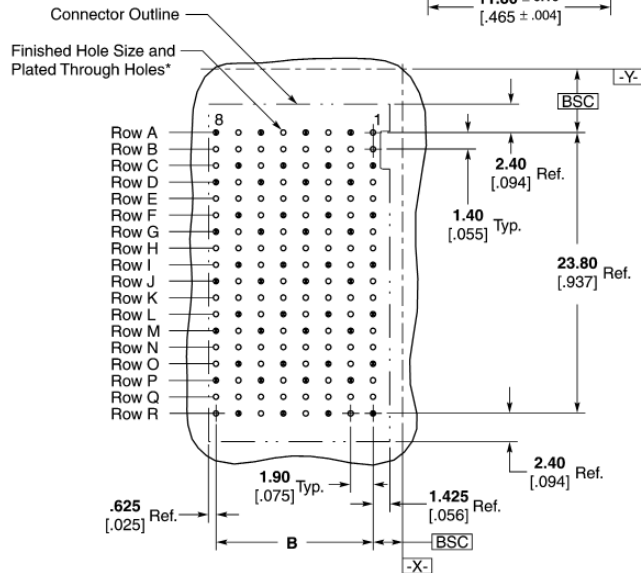
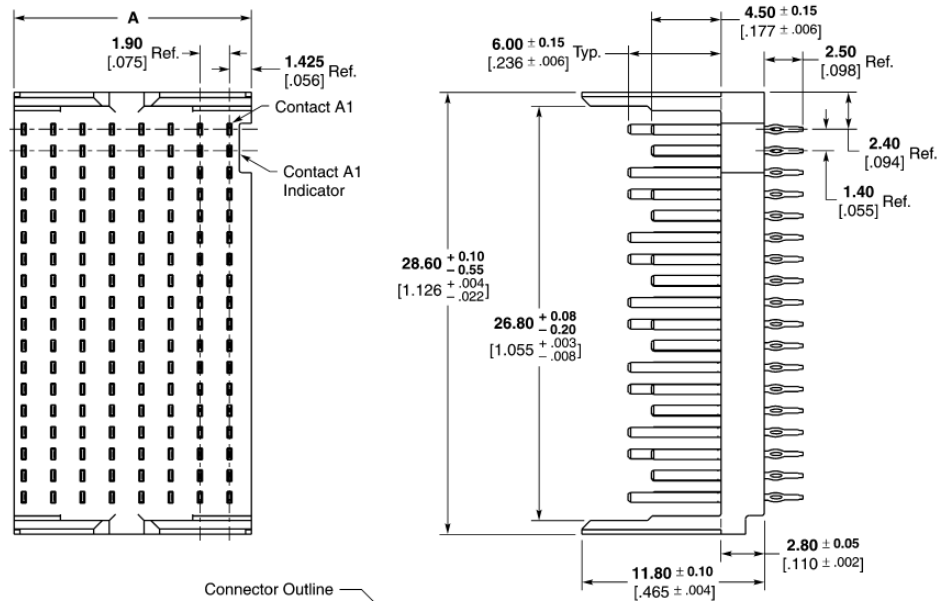

**Recommended PC Board Layout
Backplane
Component Side Shown**

Note: For additional information on pcb routing guidelines, reference the Z-PACK TinMan Connector Routing Guide Report #27GC001-1.

* Finished Hole Diameter = 0.46 ± 0.05 [.018 ± .002]
 Drilled Hole Diameter = 0.55 ± 0.02 [.022 ± .001]
 Copper Thickness = 0.038 ± 0.013 [.0015 ± .0005]
 Tin-Lead Thickness = 0.008 ± 0.004 [.0003 ± .0002]
 Finishes other than Tin-Lead, See Appl. Spec. 114-13202

Note: All part numbers are RoHS compliant. Tin-Lead parts are RoHS compliant through exemption for lead in press-fit connectors.

6 Pair Vertical Header Assemblies — Left End Wall

| Column | Part Number | Dimension | | Application Tooling | Mates With |
|--------|-------------|---------------|---------------|---------------------|------------|
| | | A | B | | |
| 8 | 1934513-1 | 16.30 .642 | 13.30 .524 | 2063383-1 | 1934504-1 |

1 Z-PACK TinMan High Speed, High Density Backplane Connector

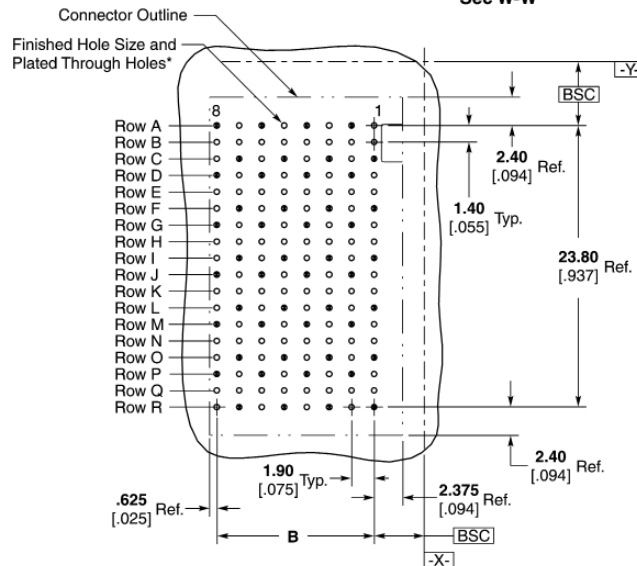
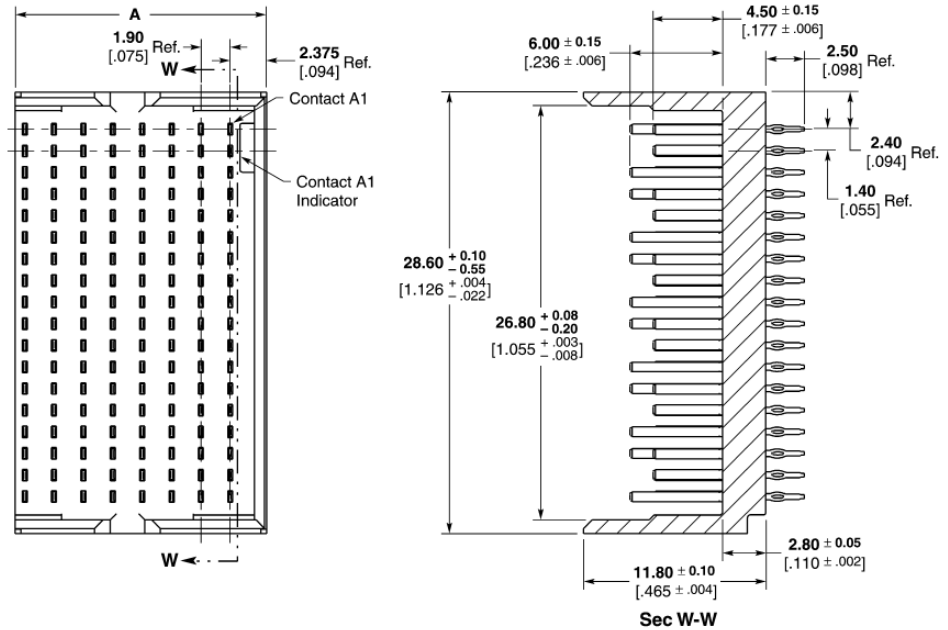

Recommended PC Board Layout Backplane Component Side Shown

Note: For additional information on pcb routing guidelines, reference the Z-PACK TinMan Connector Routing Guide Report #27GC001-1.

* Finished Hole Diameter = 0.46 ± 0.05 [.018 ± .002]
 Drilled Hole Diameter = 0.55 ± 0.02 [.022 ± .001]
 Copper Thickness = 0.038 ± 0.013 [.0015 ± .0005]
 Tin-Lead Thickness = 0.008 ± 0.004 [.0003 ± .0002]
 Finishes other than Tin-Lead, See Appl. Spec. 114-13202

Note: All part numbers are RoHS compliant. Tin-Lead parts are RoHS compliant through exemption for lead in press-fit connectors.

6 Pair Vertical Header Assemblies — Right End Wall

| Column | Part Number | Dimension | | Application Tooling | Mates With |
|--------|-------------|---------------|---------------|---------------------|------------|
| | | A | B | | |
| 8 | 1934514-1 | 17.60 .693 | 13.30 .524 | 2063383-1 | 1934504-1 |

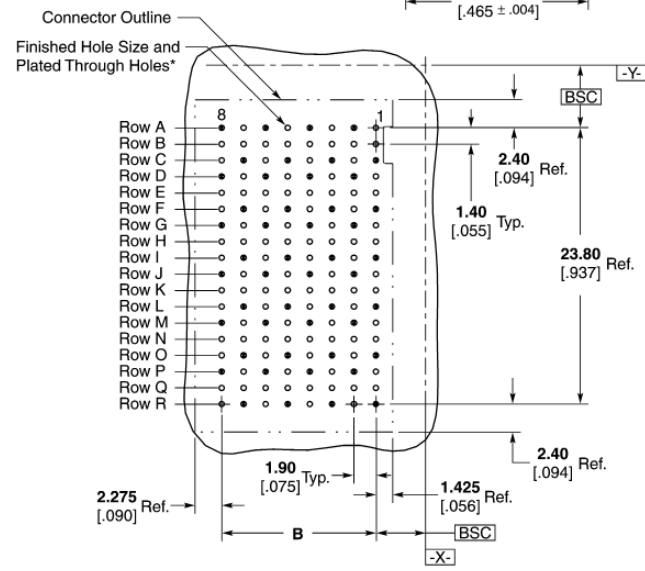
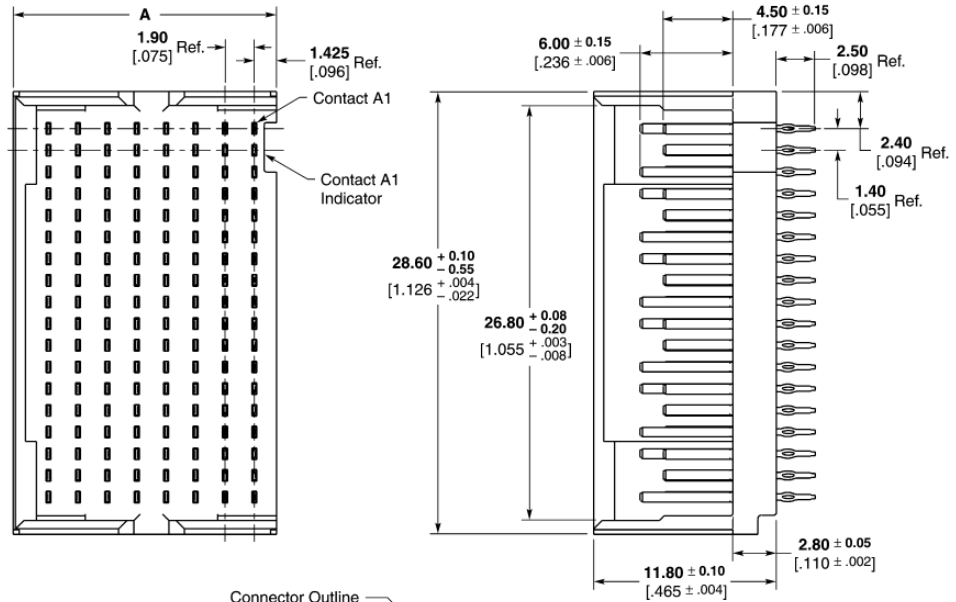

**Recommended PC Board Layout
Backplane
Component Side Shown**

Note: For additional information on pcb routing guidelines, reference the Z-PACK Tin-Mat Connector Routing Guide Report #27GC001-1.

* Finished Hole Diameter = 0.46 ± 0.05 [.018 ± .002]
 Drilled Hole Diameter = 0.55 ± 0.02 [.022 ± .001]
 Copper Thickness = 0.038 ± 0.013 [.0015 ± .0005]
 Tin-Lead Thickness = 0.008 ± 0.004 [.0003 ± .0002]
 Finishes other than Tin-Lead, See Appl. Spec. 114-13202

Note: All part numbers are RoHS compliant. Tin-Lead parts are RoHS compliant through exemption for lead in press-fit connectors.

6 Pair Vertical Header Assemblies — Double End Walls

1 Z-PACK TinMan High Speed, High Density Backplane Connector

| Column | Part Number | Dimension | | Application Tooling | Mates With |
|--------|-------------|----------------|----------------|---------------------|------------|
| | | A | B | | |
| 8 | 1934515-1 | 17.95 .707 | 13.30 .524 | 2063383-1 | 1934504-1 |
| 10 | 1934523-1 | 21.75 .856 | 17.10 .673 | 2063383-2 | 2065021-1 |
| 16 | 1934519-1 | 33.15 1.305 | 28.50 1.122 | 2063383-3 | 1934912-1 |

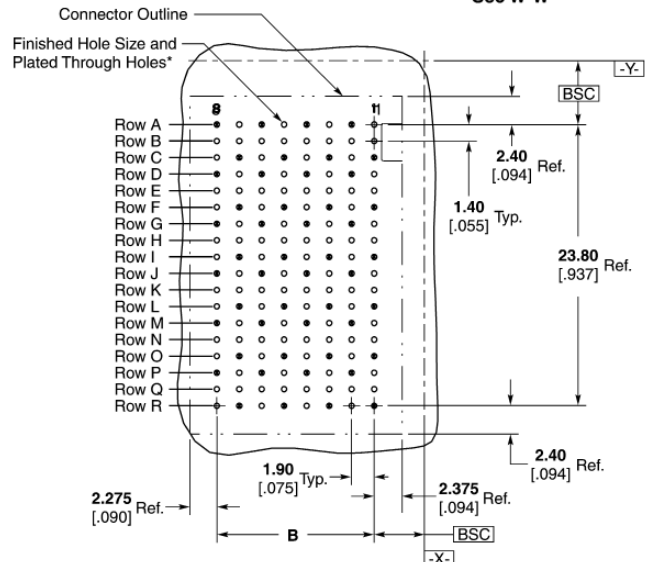
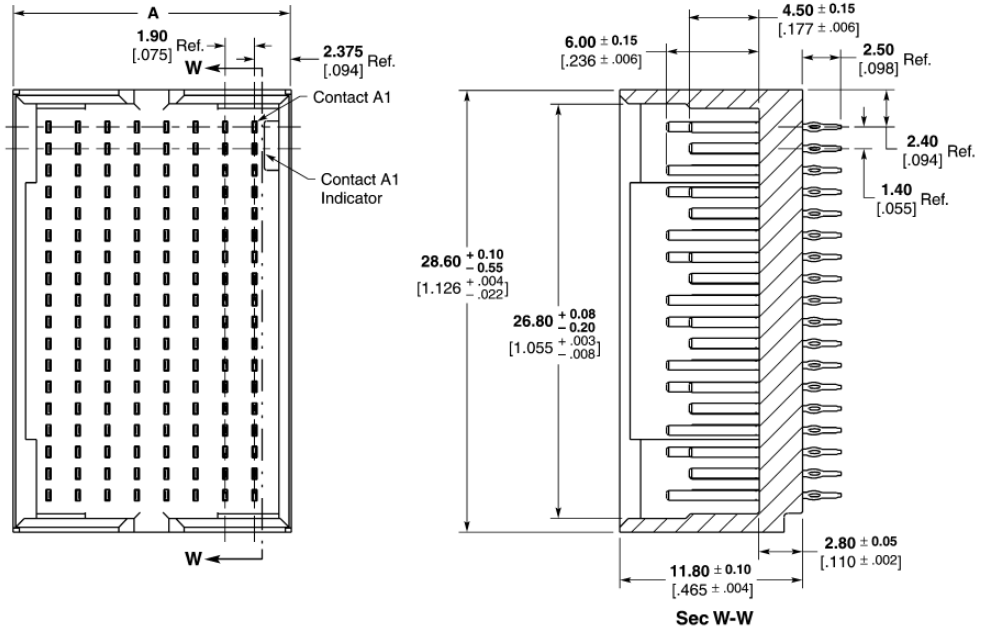

Recommended PC Board Layout Backplane Component Side Shown

Note: For additional information on pcb routing guidelines, reference the Z-PACK TinMan Connector Routing Guide Report #27GC001-1.

* Finished Hole Diameter = 0.46 ± 0.05 [0.018 ± .002]
 Drilled Hole Diameter = 0.55 ± 0.02 [0.022 ± .001]
 Copper Thickness = 0.038 ± 0.013 [0.0015 ± .0005]
 Tin-Lead Thickness = 0.008 ± 0.004 [0.0003 ± .0002]
 Finishes other than Tin-Lead, See Appl. Spec. 114-13202

Note: All part numbers are RoHS compliant. Tin-Lead parts are RoHS compliant through exemption for lead in press-fit connectors.

5 Pair Vertical Header Assemblies

| Column | Part Number | Dimension | | Application Tooling* | Mates With |
|--------|-------------|----------------|----------------|----------------------|------------|
| | | A | B | | |
| 8 | 1934269-1 | 15.35 .604 | 13.30 .524 | 1-1804791-1 | 1934218-1 |
| 10 | 1934325-1 | 19.15 .754 | 17.10 .673 | 1-1804791-7 | 1934220-1 |
| 16 | 1934331-1 | 30.55 1.203 | 28.50 1.122 | 1-1804791-3 | 1934221-1 |

* Reference Application Specification 114-13202.

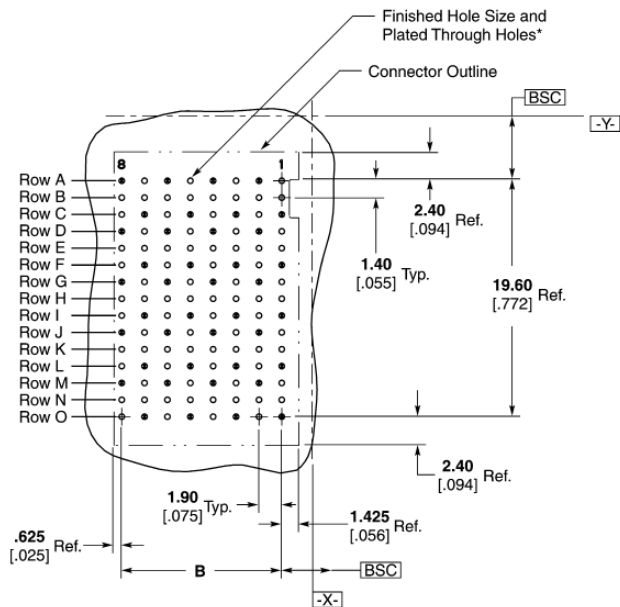
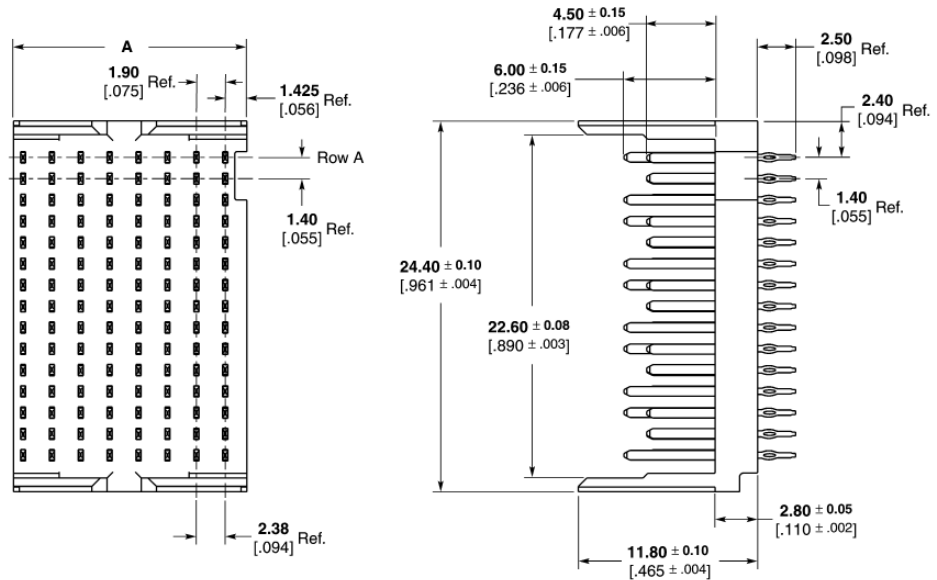

**Recommended PC Board Layout
Backplane
Component Side Shown**

Note: All part numbers are RoHS compliant. Tin-Lead parts are RoHS compliant through exemption for lead in press-fit connectors.

Note: For additional information on pcb routing guidelines, reference the Z-PACK TinMan Connector Routing Guide Report #27GC001-1.

* Finished Hole Diameter = 0.46 ± 0.05 [0.018 ± 0.002]
Drilled Hole Diameter = 0.55 ± 0.02 [0.022 ± 0.001]
Copper Thickness = 0.038 ± 0.013 [0.0015 ± 0.0005]
Tin-Lead Thickness = 0.008 ± 0.004 [0.0003 ± 0.0002]
Finishes other than Tin-Lead, See Appl. Spec. 114-13202

5 Pair Vertical Header Assemblies — Left End Wall

1 Z-PACK TinMan High Speed, High Density Backplane Connector

| Column | Part Number | Dimension | | Application Tooling* | Mates With |
|--------|-------------|----------------|----------------|----------------------|------------|
| | | A | B | | |
| 8 | 1934272-1 | 16.30 .642 | 13.30 .524 | 1-1804791-1 | 1934218-1 |
| 16 | 1934333-1 | 31.50 1.240 | 28.50 1.122 | 1-1804791-3 | 1934221-1 |

* Reference Application Specification 114-13202.

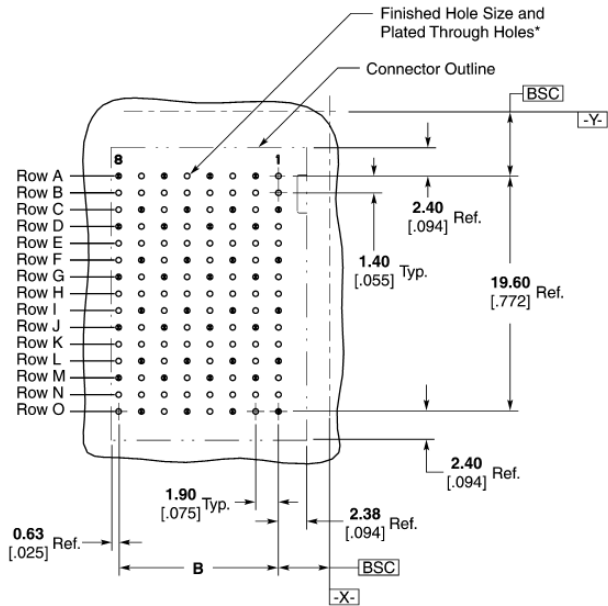
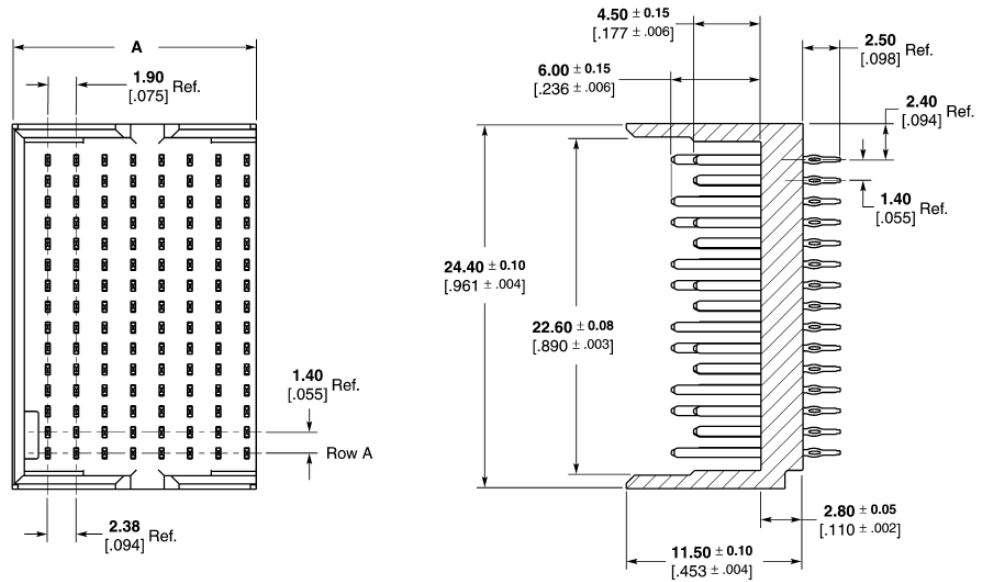

Recommended PC Board Layout Backplane Component Side Shown

Note: For additional information on pcb routing guidelines, reference the Z-PACK TinMan Connector Routing Guide Report #27GC001-1.

* Finished Hole Diameter = 0.46 ± 0.05 [0.018 ± 0.002]
 Drilled Hole Diameter = 0.55 ± 0.02 [0.022 ± 0.001]
 Copper Thickness = 0.038 ± 0.013 [0.015 ± 0.0005]
 Tin-Lead Thickness = 0.008 ± 0.004 [0.0003 ± 0.0002]
 Finishes other than Tin-Lead, See Appl. Spec. 114-13202

Note: All part numbers are RoHS compliant. Tin-Lead parts are RoHS compliant through exemption for lead in press-fit connectors.

5 Pair Vertical Header Assemblies — Right End Wall

| Column | Part Number | Dimension | | Application Tooling* | Mates With |
|--------|-------------|----------------|----------------|----------------------|------------|
| | | A | B | | |
| 8 | 1934273-1 | 17.00 .669 | 13.30 .524 | 1-1804791-1 | 1934218-1 |
| 16 | 1934334-1 | 32.20 1.268 | 28.50 1.122 | 1-1804791-3 | 1934221-1 |

* Reference Application Specification 114-13202.

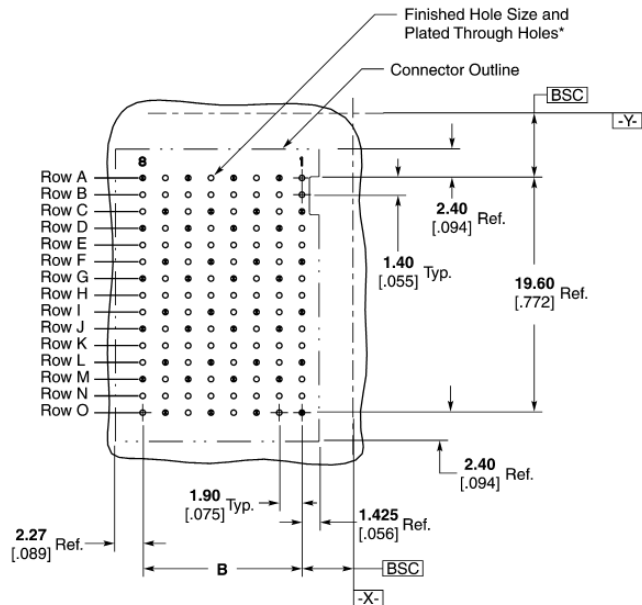
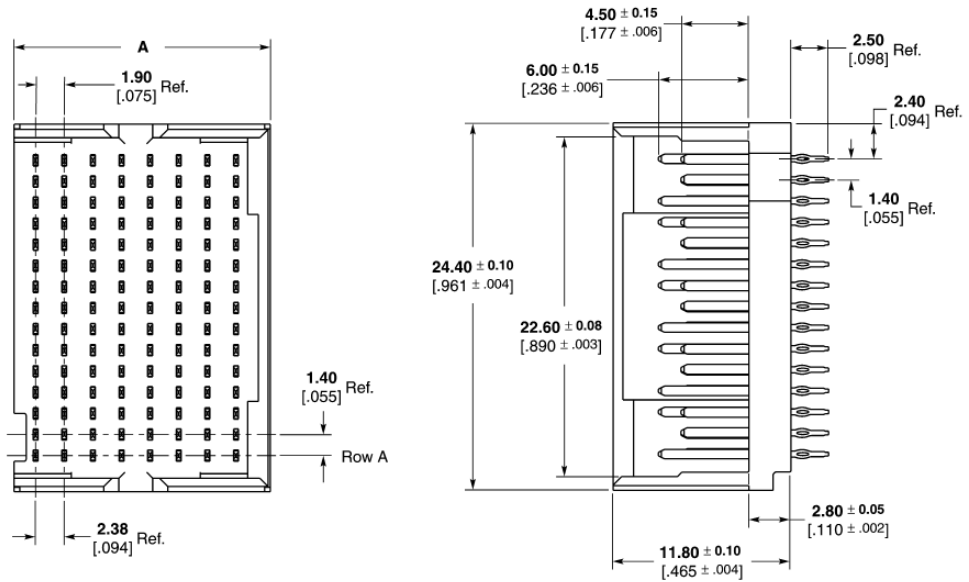

**Recommended PC Board Layout
Backplane
Component Side Shown**

Note: For additional information on pcb routing guidelines, reference the Z-PACK TinMan Connector Routing Guide Report #27GC001-1.

* Finished Hole Diameter = 0.46 ± 0.05 [0.018 ± 0.002]
 Drilled Hole Diameter = 0.55 ± 0.02 [0.022 ± 0.001]
 Copper Thickness = 0.038 ± 0.013 [0.0015 ± 0.0005]
 Tin-Lead Thickness = 0.008 ± 0.004 [0.0003 ± 0.0002]
 Finishes other than Tin-Lead, See Appl. Spec. 114-13202

Note: All part numbers are RoHS compliant. Tin-Lead parts are RoHS compliant through exemption for lead in press-fit connectors.

5 Pair Vertical Header Assemblies — Double End Walls

| Column | Part Number | Dimension | | Application Tooling* | Mates With |
|--------|-------------|----------------|----------------|----------------------|------------|
| | | A | B | | |
| 8 | 1934271-1 | 17.95 .707 | 13.30 .524 | 1-1804791-1 | 1934218-1 |
| 10 | 1934326-1 | 21.75 .856 | 17.10 .673 | 1-1804791-7 | 1934220-1 |
| 16 | 1934332-1 | 33.15 1.305 | 28.50 1.122 | 1-1804791-3 | 1934221-1 |

* Reference Application Specification 114-13202.

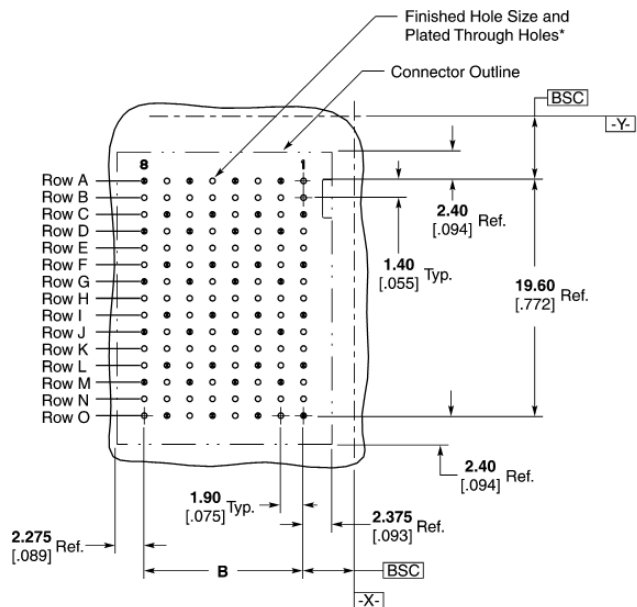
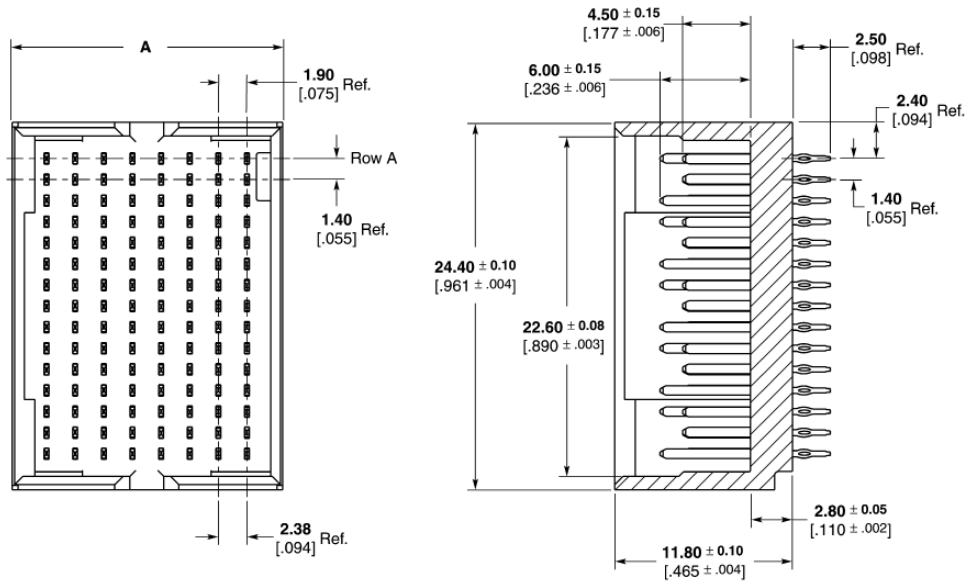

Recommended PC Board Layout Backplane Component Side Shown

Note: All part numbers are RoHS compliant. Tin-Lead parts are RoHS compliant through exemption for lead in press-fit connectors.

Note: For additional information on pcb routing guidelines, reference the Z-PACK TinMan Connector Routing Guide Report #27GC001-1.

* Finished Hole Diameter = 0.46 ± 0.05 [.018 ± .002]
 Drilled Hole Diameter = 0.55 ± 0.02 [.022 ± .001]
 Copper Thickness = 0.038 ± 0.013 [.0015 ± .0005]
 Tin-Lead Thickness = 0.008 ± 0.004 [.0003 ± .0002]
 Finishes other than Tin-Lead, See Appl. Spec. 114-13202

4 Pair Vertical Header Assemblies — Left End Wall

| Column | Part Number | Dimension | | Application Tooling* | Mates With |
|--------|-------------|----------------|----------------|----------------------|------------|
| | | A | B | | |
| 8 | 1934303-1 | 17.00 .669 | 13.30 .524 | 1-1804790-1 | 1934222-1 |
| 16 | 1934317-1 | 31.50 1.240 | 28.50 1.122 | 1-1804790-3 | 1934225-1 |

* Reference Application Specification 114-13202.

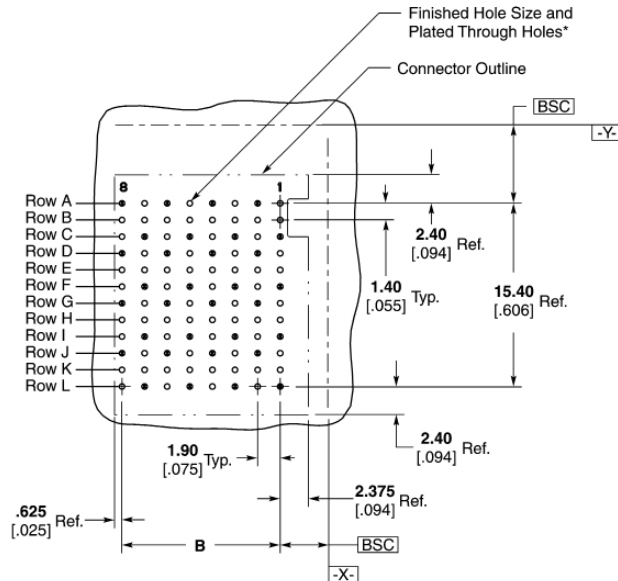
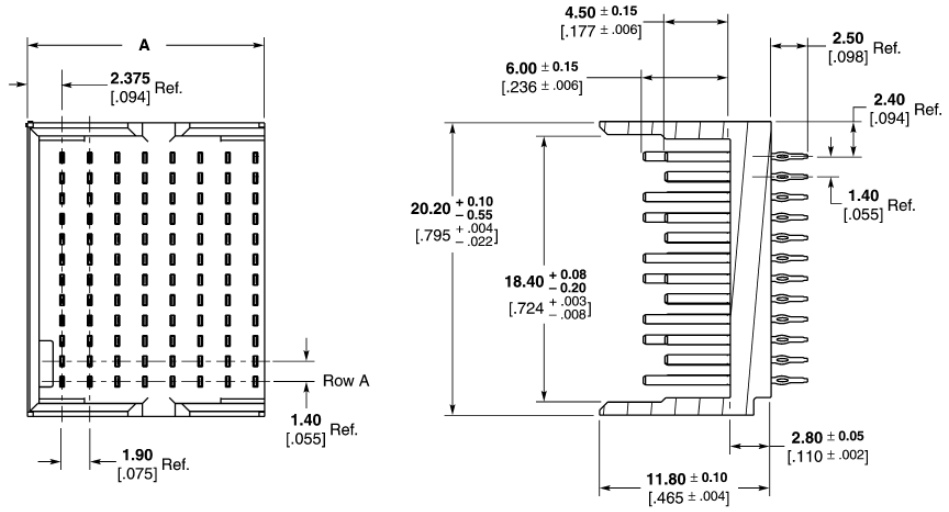

Recommended PC Board Layout Backplane Component Side Shown

Note: For additional information on pcb routing guidelines, reference the Z-PACK TinMan Connector Routing Guide Report #27GC001-1.

* Finished Hole Diameter = 0.46 ± 0.05 [.018 ± .002]
 Drilled Hole Diameter = 0.55 ± 0.02 [.022 ± .001]
 Copper Thickness = 0.038 ± 0.013 [.0015 ± .0005]
 Tin-Lead Thickness = 0.008 ± 0.004 [.0003 ± .0002]
 Finishes other than Tin-Lead, See Appl. Spec. 114-13202

Note: All part numbers are RoHS compliant. Tin-Lead parts are RoHS compliant through exemption for lead in press-fit connectors.

4 Pair Vertical Header Assemblies — Right End Wall

| Column | Part Number | Dimension | | Application Tooling* | Mates With |
|--------|-------------|----------------|----------------|----------------------|------------|
| | | A | B | | |
| 8 | 1934304-1 | 16.30 .642 | 13.30 .524 | 1-1804790-1 | 1934222-1 |
| 16 | 1934318-1 | 32.20 1.268 | 28.50 1.122 | 1-1804790-3 | 1934225-1 |

* Reference Application Specification 114-13202.

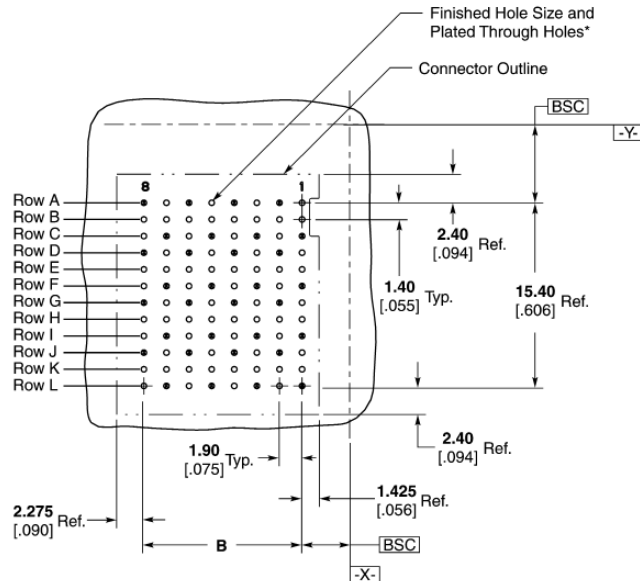
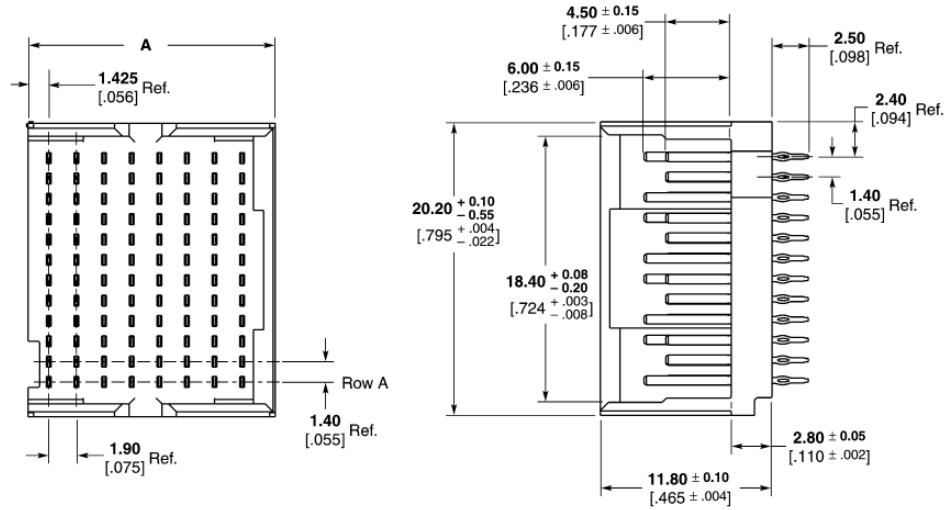

**Recommended PC Board Layout
Backplane
Component Side Shown**

Note: For additional information on pcb routing guidelines, reference the Z-PACK TinMan Connector Routing Guide Report #27GC001-1.

* Finished Hole Diameter = 0.46 ± 0.05 [.018 ± .002]
 Drilled Hole Diameter = 0.55 ± 0.02 [.022 ± .001]
 Copper Thickness = 0.038 ± 0.013 [.0015 ± .0005]
 Tin-Lead Thickness = 0.008 ± 0.004 [.0003 ± .0002]
 Finishes other than Tin-Lead, See Appl. Spec. 114-13202

Note: All part numbers are RoHS compliant. Tin-Lead parts are RoHS compliant through exemption for lead in press-fit connectors.

4 Pair Vertical Header Assemblies — Double End Walls

1 Z-PACK TinMan High Speed, High Density Backplane Connector

| Column | Part Number | Dimension | | Application Tooling* | Mates With |
|--------|-------------|----------------|----------------|----------------------|------------|
| | | A | B | | |
| 8 | 1934306-1 | 17.95 .707 | 13.30 .524 | 1-1804790-1 | 1934222-1 |
| 10 | 1934312-1 | 21.75 .856 | 17.10 .673 | 1804790-5 | 1934224-1 |
| 16 | 1934316-1 | 33.15 1.305 | 28.50 1.122 | 1-1804790-3 | 1934225-1 |

* Reference Application Specification 114-13202.

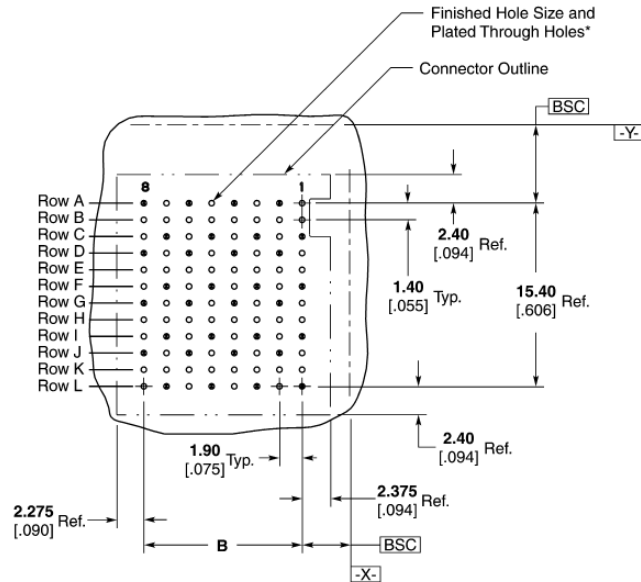
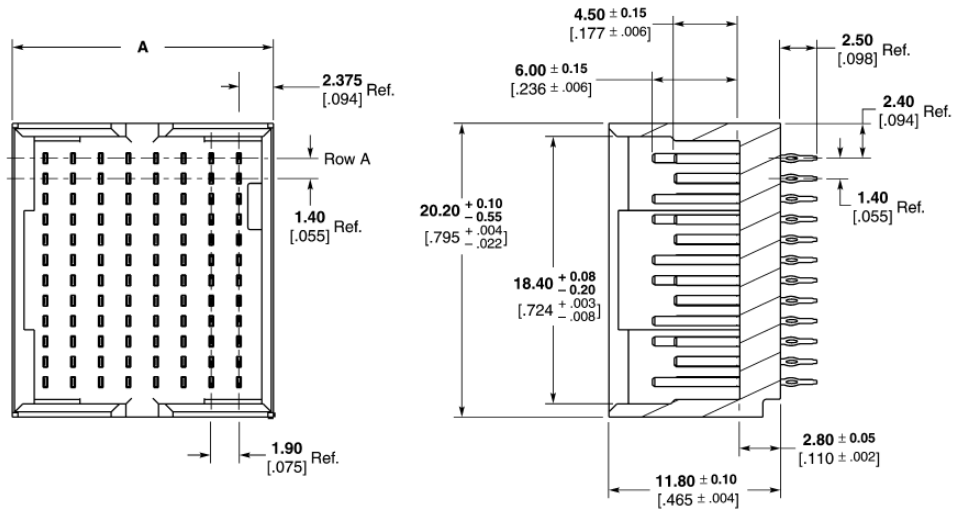

**Recommended PC Board Layout
Backplane
Component Side Shown**

Note: For additional information on pcb routing guidelines, reference the Z-PACK TinMan Connector Routing Guide Report #27GC001-1.

* Finished Hole Diameter = 0.46 ± 0.05 [.018 ± .002]
 Drilled Hole Diameter = 0.55 ± 0.02 [.022 ± .001]
 Copper Thickness = 0.038 ± 0.013 [.0015 ± .0005]
 Tin-Lead Thickness = 0.008 ± 0.004 [.0003 ± .0002]
 Finishes other than Tin-Lead, See Appl. Spec. 114-13202

Note: All part numbers are RoHS compliant. Tin-Lead parts are RoHS compliant through exemption for lead in press-fit connectors.

3 Pair Vertical Header Assemblies

| Column | Part Number | Dimension | | Application Tooling* | Mates With |
|--------|-------------|----------------|----------------|----------------------|------------|
| | | A | B | | |
| 8 | 1934299-1 | 15.35 .604 | 13.30 .524 | 1-1901457-1 | 1934226-1 |
| 10 | 1934339-1 | 19.15 .754 | 17.10 .673 | 1-1901457-2 | 1934228-1 |
| 16 | 1934343-1 | 30.55 1.203 | 28.50 1.122 | 1-1901457-3 | 1934229-1 |

* Reference Application Specification 114-13202.

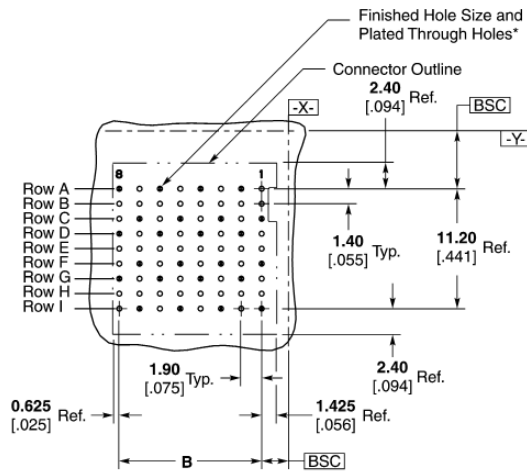
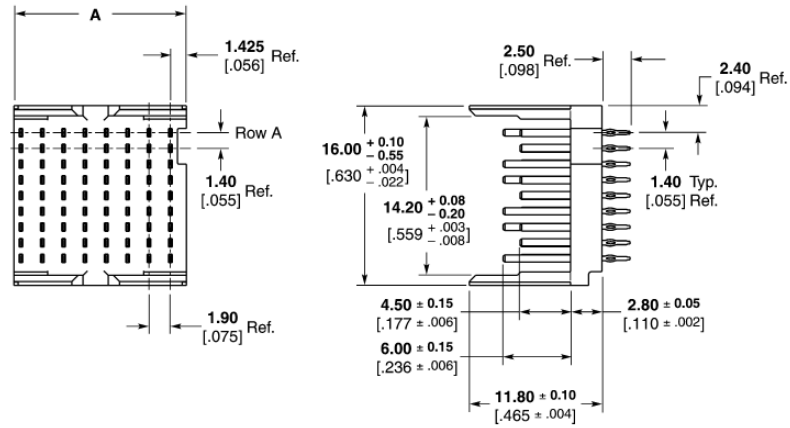

**Recommended PC Board Layout
Component Side Shown**

Note: For additional information on pcb routing guidelines, reference the Z-PACK TinMan Connector Routing Guide Report #27GC001-1.

* Finished Hole Diameter = 0.46 ± 0.05 [.018 ± .002]
 Drilled Hole Diameter = 0.55 ± 0.02 [.022 ± .001]
 Copper Thickness = 0.038 ± 0.013 [.0015 ± .0005]
 Tin-Lead Thickness = 0.008 ± 0.004 [.0003 ± .0002]
 Finishes other than Tin-Lead, See Appl. Spec. 114-13202

Note: All part numbers are RoHS compliant. Tin-Lead parts are RoHS compliant through exemption for lead in press-fit connectors.

3 Pair Vertical Header Assemblies — Left End Wall

| Column | Part Number | Dimension | | Application Tooling* | Mates With |
|--------|-------------|----------------|----------------|----------------------|------------|
| | | A | B | | |
| 8 | 1934300-1 | 16.30 .642 | 13.30 .524 | 1-1901457-1 | 1934226-1 |
| 10 | 1934340-1 | 20.10 .791 | 17.10 .673 | 1-1901457-2 | 1934228-1 |
| 16 | 1934344-1 | 31.50 1.240 | 28.50 1.122 | 1-1901457-3 | 1934229-1 |

* Reference Application Specification 114-13202.

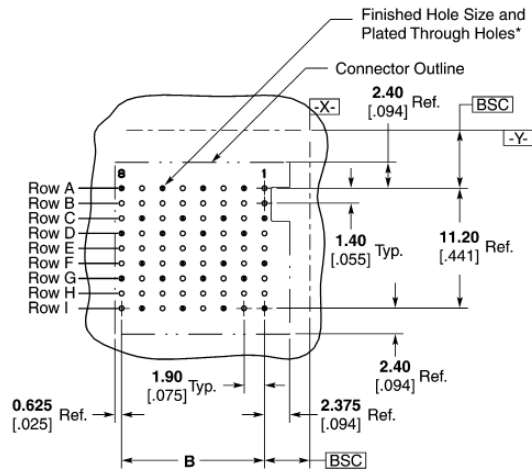
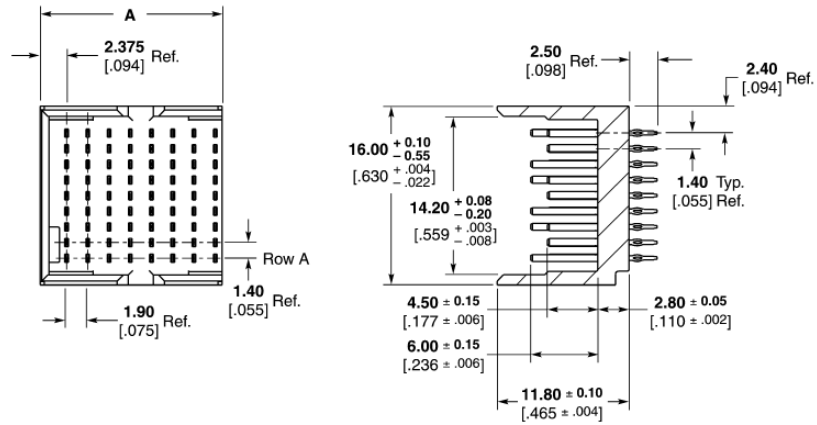

**Recommended PC Board Layout
Component Side Shown**

Note: For additional information on pcb routing guidelines, reference the Z-PACK TinMan Connector Routing Guide Report #27GC001-1.

* Finished Hole Diameter = 0.46 ± 0.05 [.018 ± .002]
 Drilled Hole Diameter = 0.55 ± 0.02 [.022 ± .001]
 Copper Thickness = 0.038 ± 0.013 [.0015 ± .0005]
 Tin-Lead Thickness = 0.008 ± 0.004 [.0003 ± .0002]
 Finishes other than Tin-Lead, See Appl. Spec. 114-13202

Note: All part numbers are RoHS compliant. Tin-Lead parts are RoHS compliant through exemption for lead in press-fit connectors.

3 Pair Vertical Header Assemblies — Right End Wall

| Column | Part Number | Dimension | | Application Tooling* | Mates With |
|--------|-------------|----------------|----------------|----------------------|------------|
| | | A | B | | |
| 8 | 1934301-1 | 17.00 .669 | 13.30 .524 | 1-1901457-1 | 1934226-1 |
| 10 | 1934341-1 | 20.08 .791 | 17.10 .673 | 1-1901457-2 | 1934228-1 |
| 16 | 1934345-1 | 32.20 1.268 | 28.50 1.122 | 1-1901457-3 | 1934229-1 |

* Reference Application Specification 114-13202.

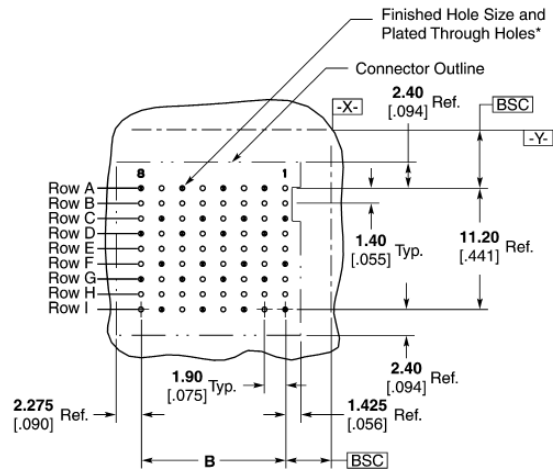
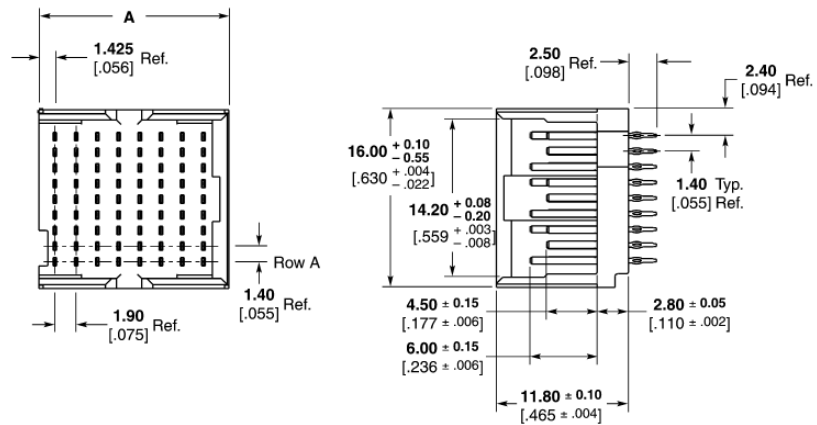

**Recommended PC Board Layout
Component Side Shown**

Note: For additional information on pcb routing guidelines, reference the Z-PACK TinMan Connector Routing Guide Report #27GC001-1.

* Finished Hole Diameter = 0.46 ± 0.05 [0.018 ± 0.002]
 Drilled Hole Diameter = 0.55 ± 0.02 [0.022 ± 0.001]
 Copper Thickness = 0.038 ± 0.013 [0.0015 ± 0.0005]
 Tin-Lead Thickness = 0.008 ± 0.004 [0.0003 ± 0.0002]
 Finishes other than Tin-Lead, See Appl. Spec. 114-13202

Note: All part numbers are RoHS compliant. Tin-Lead parts are RoHS compliant through exemption for lead in press-fit connectors.

3 Pair Vertical Header Assemblies — Double End Walls

| Column | Part Number | Dimension | | Application Tooling* | Mates With |
|--------|-------------|----------------|----------------|----------------------|------------|
| | | A | B | | |
| 8 | 1934302-1 | 17.95 .707 | 13.30 .524 | 1-1901457-1 | 1934226-1 |
| 10 | 1934342-1 | 21.75 .856 | 17.10 .673 | 1-1901457-2 | 1934228-1 |
| 16 | 1934346-1 | 33.15 1.305 | 28.50 1.122 | 1-1901457-3 | 1934229-1 |

* Reference Application Specification 114-13202.

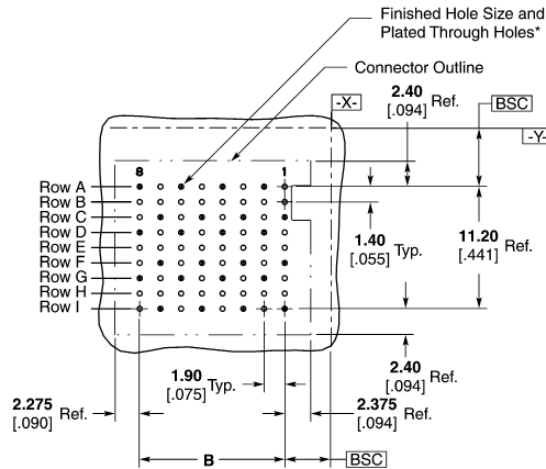
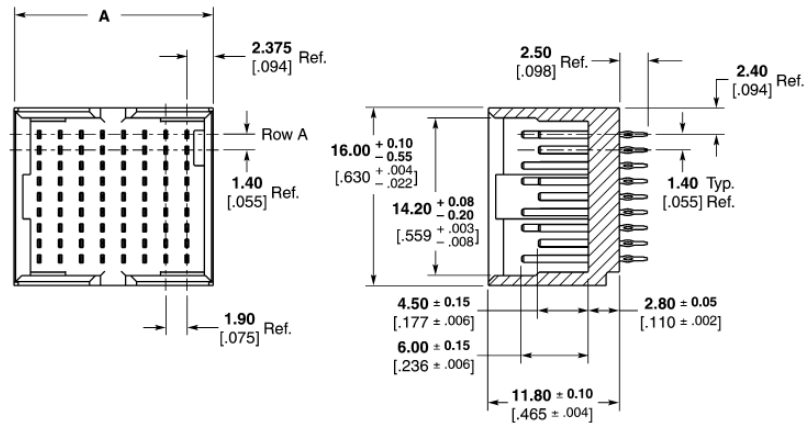

**Recommended PC Board Layout
Component Side Shown**

Note: For additional information on pcb routing guidelines, reference the Z-PACK TinMan Connector Routing Guide Report #27GC001-1.

* Finished Hole Diameter = 0.46 ± 0.05 [.018 ± 0.002]
 Drilled Hole Diameter = 0.55 ± 0.02 [.022 ± 0.001]
 Copper Thickness = 0.038 ± 0.013 [.0015 ± 0.0005]
 Tin-Lead Thickness = 0.008 ± 0.004 [.0003 ± 0.0002]
 Finishes other than Tin-Lead, See Appl. Spec. 114-13202

Note: All part numbers are RoHS compliant. Tin-Lead parts are RoHS compliant through exemption for lead in press-fit connectors.

5 Pair Right Angle Pin Header Assemblies

| Column | Part Number | Dimension | | Application Tooling | Mates With |
|--------|-------------|----------------|----------------|---------------------|------------|
| | | A | B | | |
| 8 | 1934349-1 | 15.35 .604 | 13.30 .524 | * | 1934218-1 |
| 16 | 1934347-1 | 30.55 1.203 | 28.50 1.122 | * | 1934221-1 |

* Custom tooling not required. Utilizes flat-rock insertion tooling.
Reference Application Specification 114-13202.

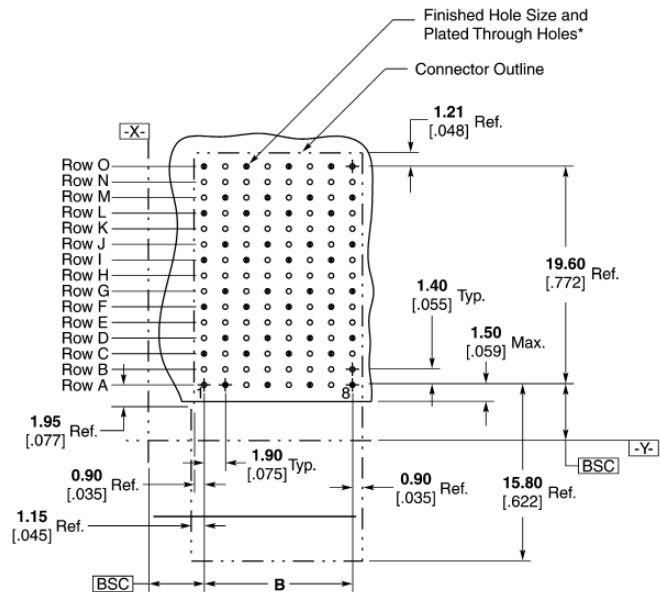
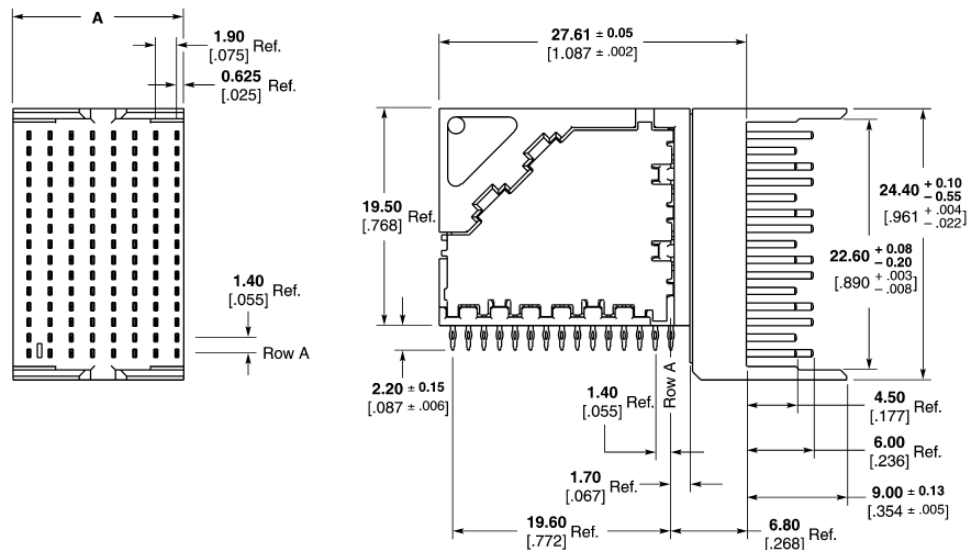

Recommended PC Board Layout
Component Side Shown

Note: For additional information on pcb routing guidelines, reference the Z-PACK TinMan Connector Routing Guide Report #27GC001-1.

* Finished Hole Diameter = 0.46 ± 0.05 [0.018 ± 0.002]
Drilled Hole Diameter = 0.55 ± 0.02 [0.022 ± 0.001]
Copper Thickness = 0.038 ± 0.013 [0.0015 ± 0.0005]
Tin-Lead Thickness = 0.008 ± 0.004 [0.0003 ± 0.0002]
Finishes other than Tin-Lead, See Appl. Spec. 114-13202

Note: All part numbers are RoHS compliant. Tin-Lead parts are RoHS compliant through exemption for lead in press-fit connectors.

5 Pair Right Angle Pin Header Assemblies — Double End Walls

1 Z-PACK TinMan High Speed, High Density Backplane Connector

| Column | Part Number | Dimension | | Application Tooling | Mates With |
|--------|-------------|-----------------|----------------|---------------------|------------|
| | | A | B | | |
| 8 | 1934350-1 | 18.05 [.711] | 13.30 .524 | * | 1934218-1 |
| 16 | 1934348-1 | 33.25 1.309 | 28.50 1.122 | * | 1934221-1 |

* Custom tooling not required. Utilizes flat-rock insertion tooling.
Reference Application Specification 114-13202.

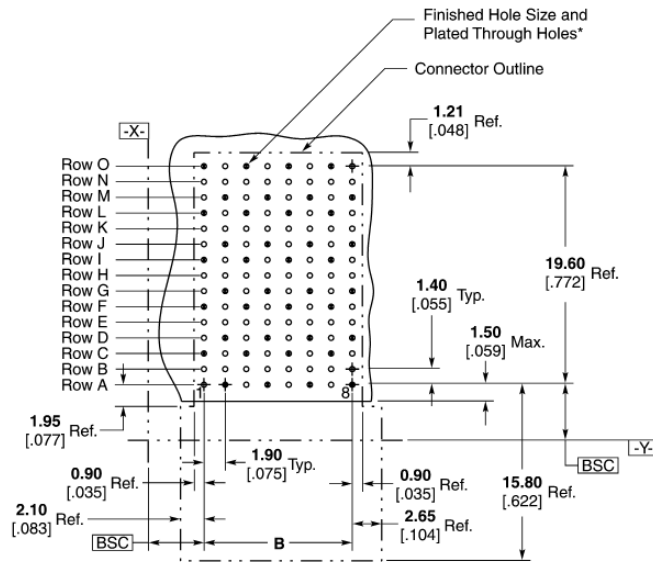
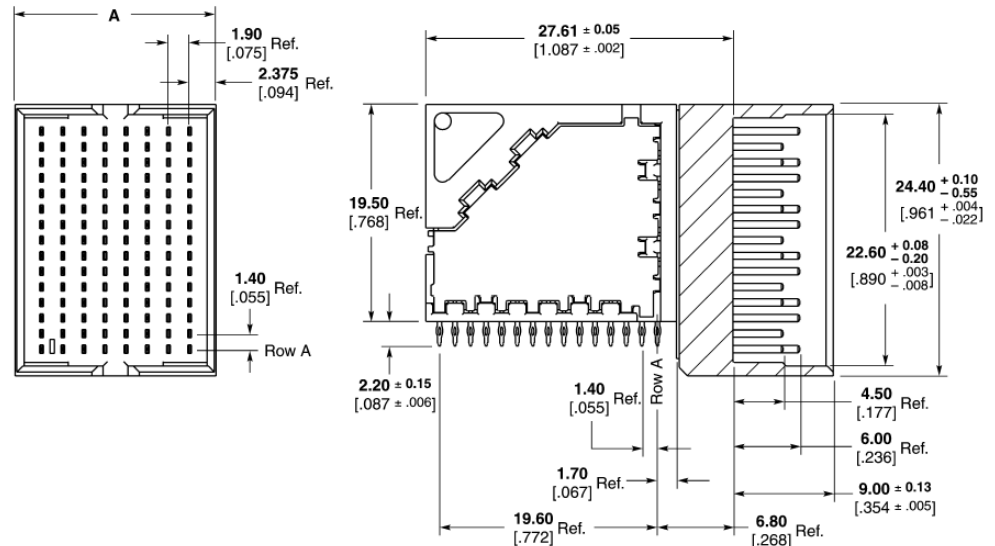

**Recommended PC Board Layout
Component Side Shown**

Note: For additional information on pcb routing guidelines, reference the Z-PACK TinMan Connector Routing Guide Report #27GC001-1.

* Finished Hole Diameter = 0.46 ± 0.05 [0.018 ± .002]
 Drilled Hole Diameter = 0.55 ± 0.02 [0.022 ± .001]
 Copper Thickness = 0.038 ± 0.013 [0.0015 ± .0005]
 Tin-Lead Thickness = 0.008 ± 0.004 [0.0003 ± .0002]
 Finishes other than Tin-Lead, See Appl. Spec. 114-13202

Note: All part numbers are RoHS compliant. Tin-Lead parts are RoHS compliant through exemption for lead in press-fit connectors.

4 Pair Right Angle Pin Header Assemblies

| Column | Part Number | Dimension | | Application Tooling | Mates With |
|--------|-------------|----------------|----------------|---------------------|------------|
| | | A | B | | |
| 8 | 1934353-1 | 15.35 .604 | 13.30 .524 | * | 1934222-1 |
| 16 | 1934351-1 | 30.55 1.203 | 28.50 1.122 | * | 1934225-1 |

* Custom tooling not required. Utilizes flat-rock insertion tooling.
Reference Application Specification 114-13202.

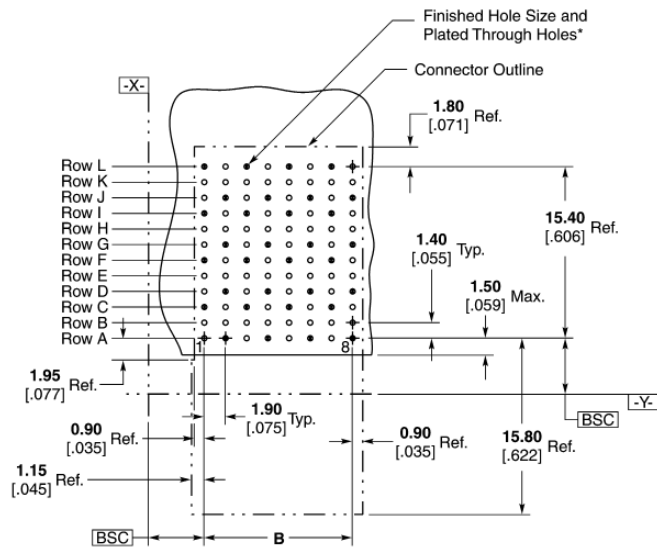
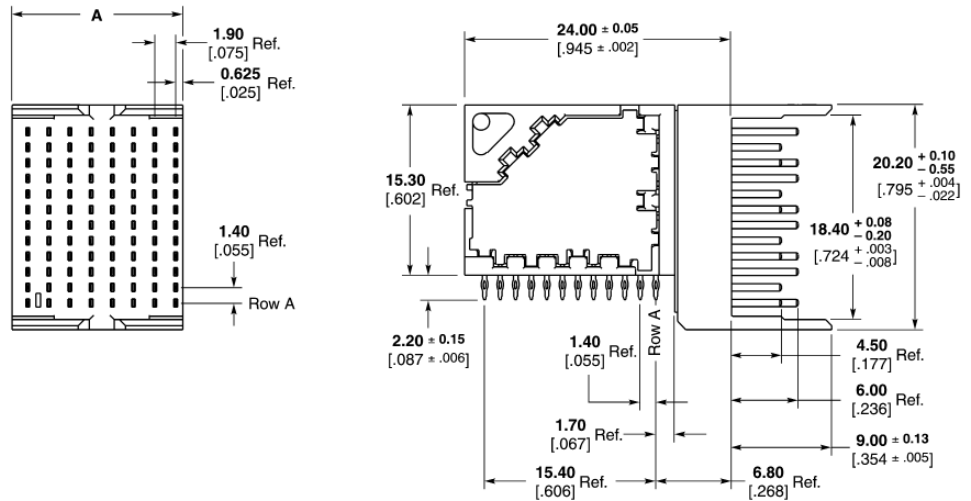

**Recommended PC Board Layout
Component Side Shown**

Note: For additional information on pcb routing guidelines, reference the Z-PACK Tin-Mat Connector Routing Guide Report #27GC001-1.

* Finished Hole Diameter = 0.46 ± 0.05 [.018 ± .002]
Drilled Hole Diameter = 0.55 ± 0.02 [.022 ± .001]
Copper Thickness = 0.038 ± 0.013 [.0015 ± .0005]
Tin-Lead Thickness = 0.008 ± 0.004 [.0003 ± .0002]
Finishes other than Tin-Lead, See Appl. Spec. 114-13202

Note: All part numbers are RoHS compliant. Tin-Lead parts are RoHS compliant through exemption for lead in press-fit connectors.

4 Pair Right Angle Pin Header Assemblies — Double End Walls

1 Z-PACK TinMan High Speed, High Density Backplane Connector

| Column | Part Number | Dimension | | Application Tooling | Mates With |
|--------|-------------|----------------|----------------|---------------------|------------|
| | | A | B | | |
| 8 | 1934354-1 | 18.05 .711 | 13.30 .524 | * | 1934222-1 |
| 16 | 1934352-1 | 33.25 1.309 | 28.50 1.122 | * | 1934225-1 |

* Custom tooling not required. Utilizes flat-rock insertion tooling.
Reference Application Specification 114-13202.

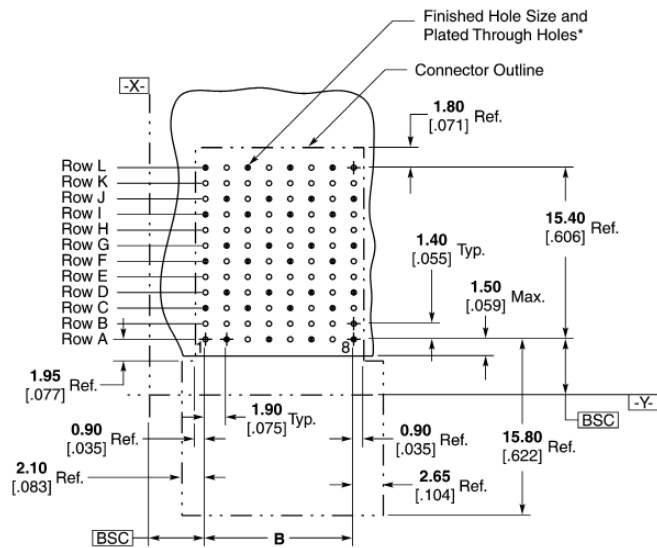
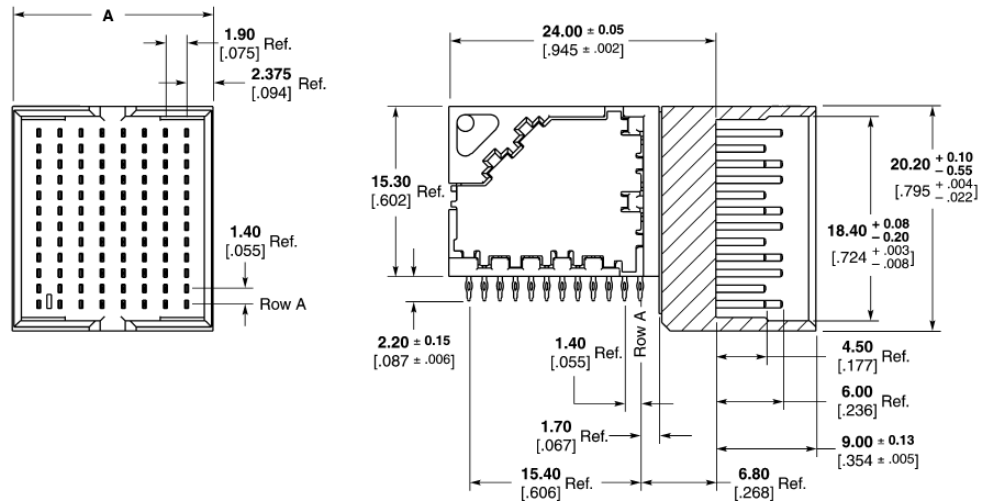

**Recommended PC Board Layout
Component Side Shown**

Note: For additional information on pcb routing guidelines, reference the Z-PACK TinMan Connector Routing Guide Report #27GC001-1.

* Finished Hole Diameter = 0.46 ± 0.05 [.018 ± .002]
 Drilled Hole Diameter = 0.55 ± 0.02 [.022 ± .001]
 Copper Thickness = 0.038 ± 0.013 [.0015 ± .0005]
 Tin-Lead Thickness = 0.008 ± 0.004 [.0003 ± .0002]
 Finishes other than Tin-Lead, See Appl. Spec. 114-13202

Note: All part numbers are RoHS compliant. Tin-Lead parts are RoHS compliant through exemption for lead in press-fit connectors.

3 Pair Right Angle Pin Header Assemblies

| Column | Part Number | Dimension | | Application Tooling | Mates With |
|--------|-------------|----------------|----------------|---------------------|------------|
| | | A | B | | |
| 8 | 1934359-1 | 15.35 .604 | 13.30 .524 | * | 1934226-1 |
| 10 | 1934357-1 | 19.15 .754 | 17.10 .673 | * | 1934228-1 |
| 16 | 1934355-1 | 30.55 1.203 | 28.50 1.122 | * | 1934229-1 |

* Custom tooling not required. Utilizes flat-rock insertion tooling.
Reference Application Specification 114-13202.

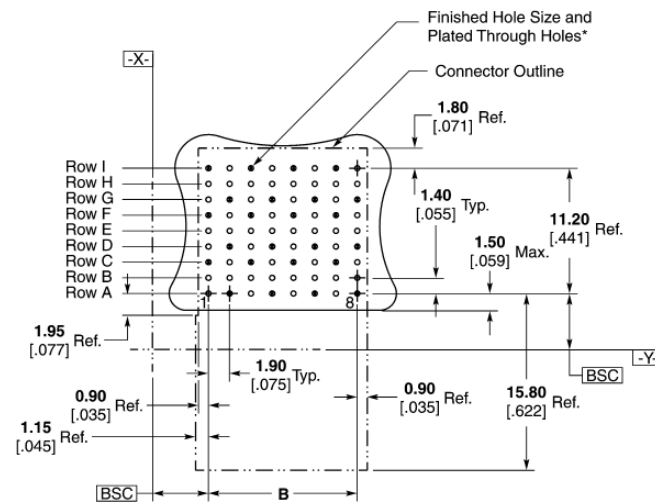
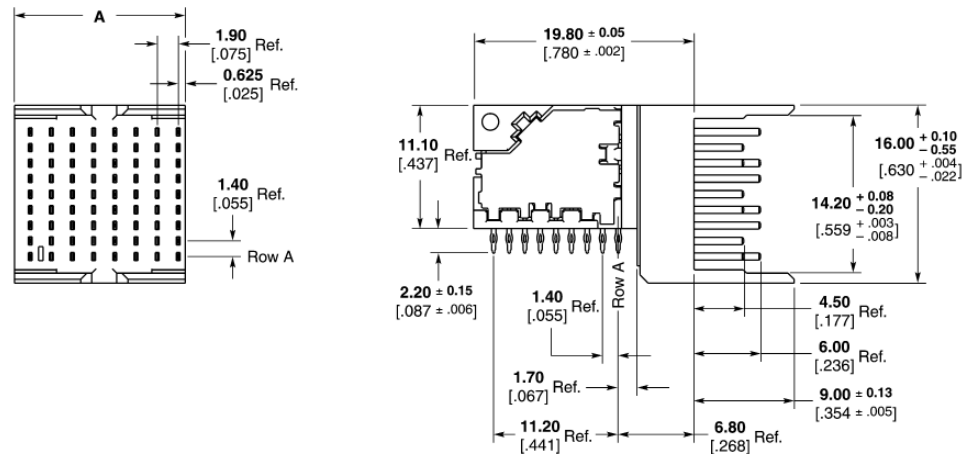

**Recommended PC Board Layout
Component Side Shown**

Note: For additional information on pcb routing guidelines, reference the Z-PACK TinMan Connector Routing Guide Report #27GC001-1.

* Finished Hole Diameter = 0.46 ± 0.05 [.018 ± .002]
Drilled Hole Diameter = 0.55 ± 0.02 [.022 ± .001]
Copper Thickness = 0.038 ± 0.013 [.0015 ± .0005]
Tin-Lead Thickness = 0.008 ± 0.004 [.0003 ± .0002]
Finishes other than Tin-Lead, See Appl. Spec. 114-13202

Note: All part numbers are RoHS compliant. Tin-Lead parts are RoHS compliant through exemption for lead in press-fit connectors.

3 Pair Right Angle Pin Header Assemblies — Double End Walls

1 Z-PACK TinMan High Speed, High Density Backplane Connector

| Column | Part Number | Dimension | | Application Tooling | Mates With |
|--------|-------------|----------------|----------------|---------------------|------------|
| | | A | B | | |
| 8 | 1934360-1 | 18.05 .711 | 13.30 .524 | * | 1934226-1 |
| 10 | 1934358-1 | 21.85 .860 | 17.10 .673 | * | 1934228-1 |
| 16 | 1934356-1 | 33.25 1.309 | 28.50 1.122 | * | 1934229-1 |

* Custom tooling not required. Utilizes flat-rock insertion tooling.
Reference Application Specification 114-13202.

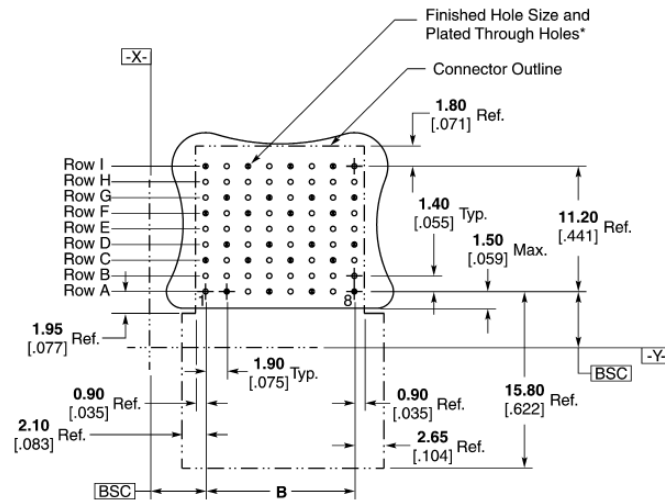
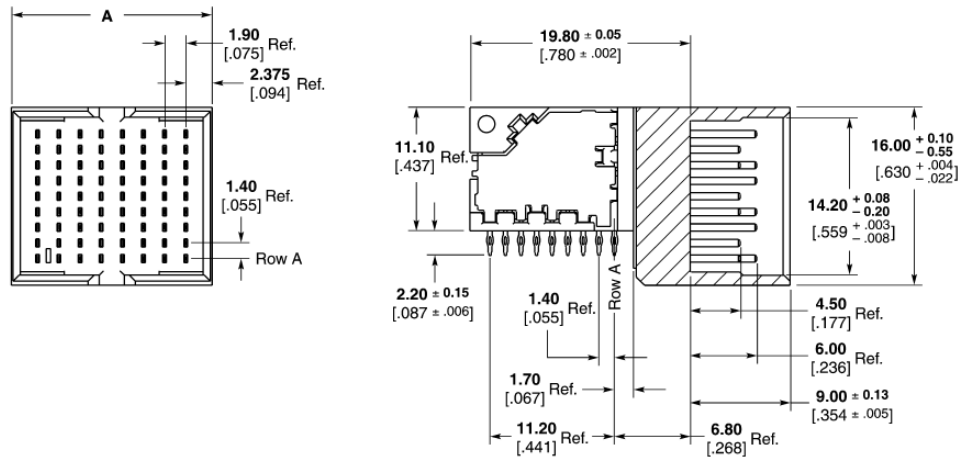

**Recommended PC Board Layout
Component Side Shown**

Note: For additional information on pcb routing guidelines, reference the Z-PACK TinMan Connector Routing Guide Report #27GC001-1.

* Finished Hole Diameter = 0.46 ± 0.05 [0.018 ± .002]
Drilled Hole Diameter = 0.55 ± 0.02 [0.022 ± .001]
Copper Thickness = 0.038 ± 0.013 [0.0015 ± .0005]
Tin-Lead Thickness = 0.008 ± 0.004 [0.0003 ± .0002]
Finishes other than Tin-Lead, See Appl. Spec. 114-13202

Note: All part numbers are RoHS compliant. Tin-Lead parts are RoHS compliant through exemption for lead in press-fit connectors.

Z-PACK TinMan Midplane (Orthogonal) Connector Overview

Product Facts

- Scalable to 25 Gbps
- 100 ohm impedance for differential pair configuration
- Very low noise
- Outstanding insertion loss through 2 connectors and vias
- Skewless differential pair in a 2-connector system
- Utilizes the same header and receptacle part on both sides of the midplane
- Compatible with standard Z-PACK TinMan connectors and accessories
- 4 pair x 4 pair and 6 pair x 6 pair modules available
- Reliable, redundant contact design on all contacts
- Reliable press-fit style termination to PCB
- RoHS compliant

Applications

The Z-PACK TinMan midplane (orthogonal) connector is ideally designed for very demanding applications involving data rates in excess of 10 Gbps with many interconnections required. Such applications would include the following Telecom/Datacom equipment:

- Switches
- Servers
- Routers
- Storage

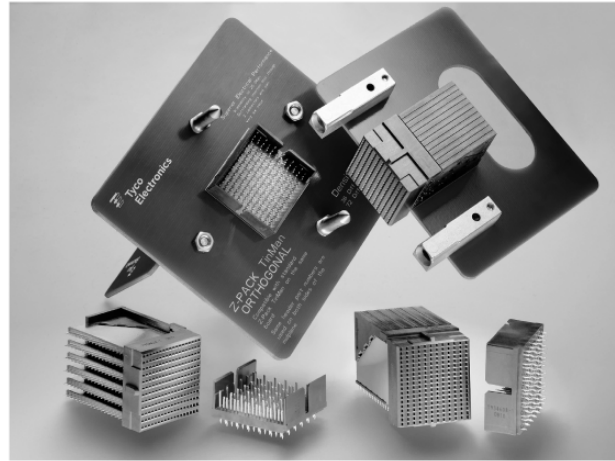

The Z-PACK TinMan midplane (orthogonal) connector is an extension of the Z-PACK TinMan connector product line, which includes perpendicular and coplanar interconnect solutions in 3 pair, 4 pair, and 5 pair versions.

This connector system is commonly referred to as an orthogonal connector system due to the orthogonal (perpendicular) orientation of the two system boards being connected on the front and rear side. It is built on the same technology and design approach as standard Z-PACK TinMan connectors with the same mating interface and lead-frame geometry.

Superior electrical performance is achieved for several reasons. The front board to

rear board connection through the midplane makes the plated through hole (PTH) part of the signal transmission path eliminating the detrimental effects of via stubs. This construction also eliminates the need to route all the high speed signal lines along the backplane minimizing signal loss and significantly improving signal throughput. The wide column spacing establishes a connector footprint with improved impedance and reduced electrical noise. The in-line footprint version also provides ease of trace routing with wide channels and a connector interface compatible with the orthogonal receptacle. This permits the use of the same daughtercard in both midplane and backplane configurations.

The benefits are not limited to just signal integrity performance. The thinner midplane with fewer layers and significantly less complex routing is inherently less expensive. With trace routing typically limited to power distribution, low speed lines and potentially very few high speed links, the board can be fabricated from a cost effective material without the need to utilize techniques such as counter-boring or back-drilling.

All of this permits the implementation of small to large scale full mesh interconnects with significantly reduced complexity at a lower cost and with improved signal integrity.

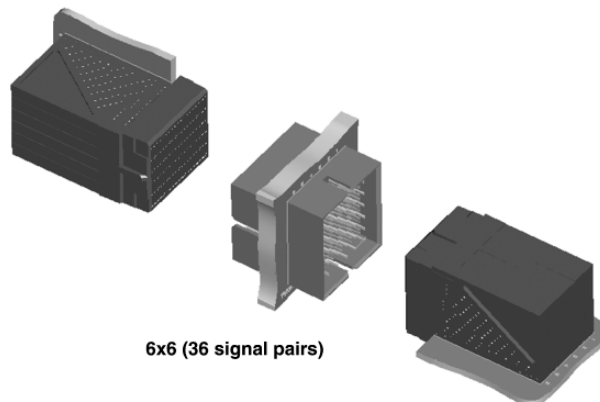

6x6 (36 signal pairs)

For additional information visit:
<http://www.tycoelectronics.com/zpacktinman>

Z-PACK TinMan Midplane (6 x 12 Orthogonal) Connector Overview

Noise Table

- Maximum, multiple source crosstalk

Technical Documents

Product Specification 108-2303

Application Specification 114-13202

Routing Guide Report #27GC002

Material and Finish

Signal Contact — High Strength Copper Alloy

Ground Contact — High Strength Copper Alloy

Housing — Liquid Crystal Polymer, UL 94V-0 Rated

Platings — Telcordia compliant interface, Nickel underplate

Compliant Pin Plating — RoHS Compliant

Ratings

Temperature Range — -65°C to +90°C

Current Rating — 0.5 A/contact @ < 30°C T-Rise

Durability — 200 cycles

Dielectric Withstanding Voltage — 560 VAC

Operating Voltage — 250 VAC max.

Signal Integrity

Characteristic Impedance — Differential @ 100 ohms ±10%

Crosstalk — Multi-pair differential crosstalk: 1.0% @ 50ps

Insertion Loss — -2 dB @ 10 GHz

| Pair | Total Peak |
|------|------------|
| AB | 1.2% |
| BC | N/A |
| DE | 2.5% |
| EF | 2.4% |
| GH | 2.5% |
| HI | 2.7% |
| JK | 2.8% |
| KL | 2.8% |
| MN | 3.0% |
| NO | 2.9% |
| PQ | 2.3% |
| QR | 1.4% |

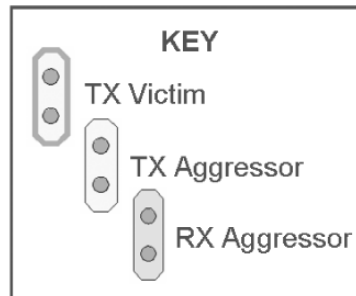
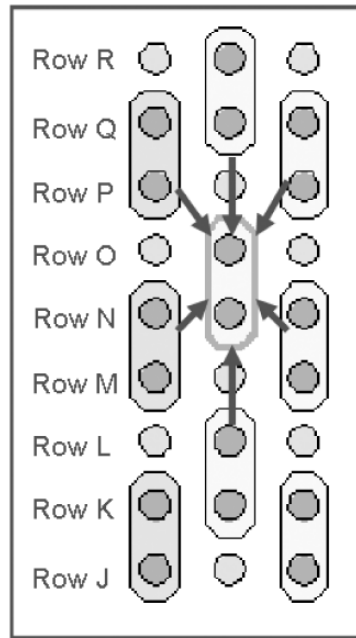

Insertion Loss Plot

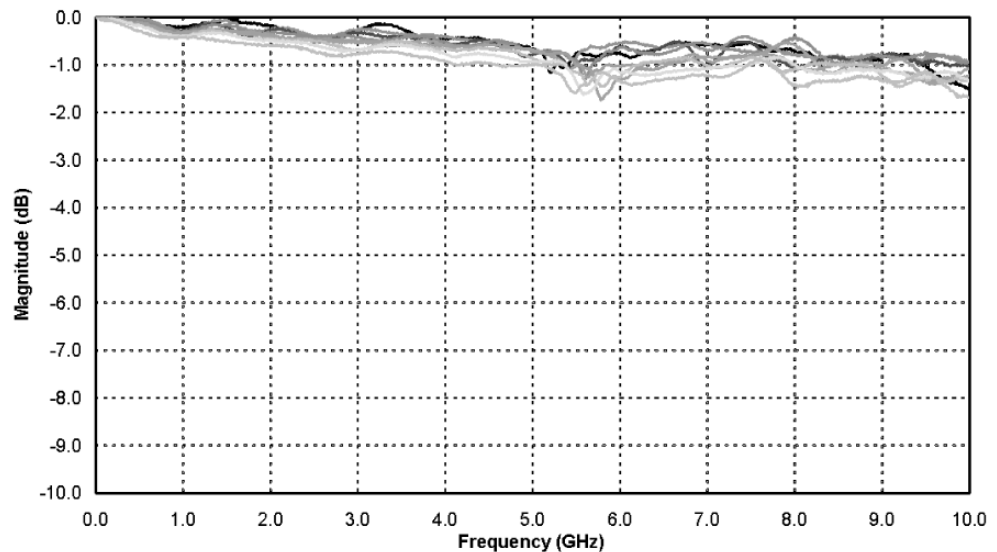

| | | |
|-------------------------|-------------------------|-------------------------|
| — SDD21 Mag(dB) AB Pair | — SDD21 Mag(dB) DE Pair | — SDD21 Mag(dB) EF Pair |
| — SDD21 Mag(dB) GH Pair | — SDD21 Mag(dB) HI Pair | — SDD21 Mag(dB) JK Pair |
| — SDD21 Mag(dB) KL Pair | — SDD21 Mag(dB) MN Pair | — SDD21 Mag(dB) NO Pair |

TELCORDIA is a trademark of Telcordia Technologies, Inc.

Z-PACK TinMan Midplane (6 x 12 Orthogonal) Connector Overview (Continued)

Representative Eye Pattern

- 10.0 Gbps data rate
- 2⁻¹ PRBS
- Unequalized Signal

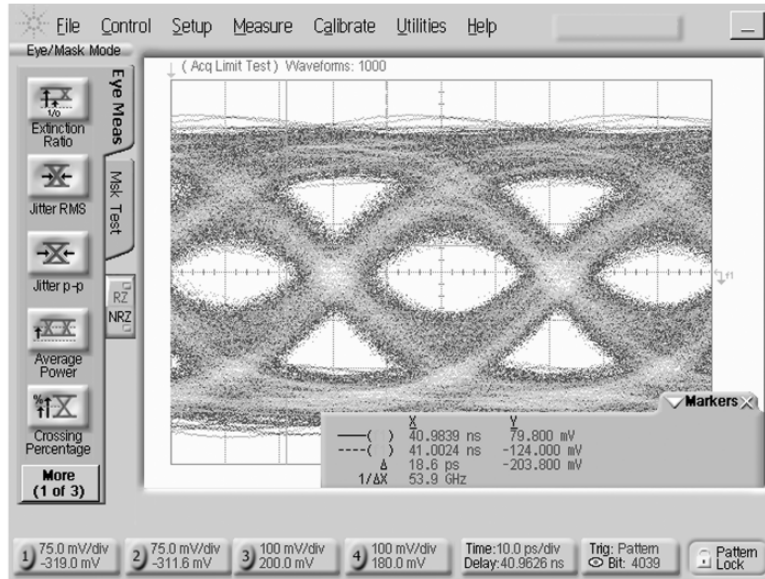

Customer Connector Evaluation Kit

- Connector characterization
- Available for loan — contact your local Tyco Electronics Sales Engineer
- Time and frequency domain testable
- Testable to 18+ GHz (25+ Gb/s)
- Multiple calibration options
- Convenient SMA interface

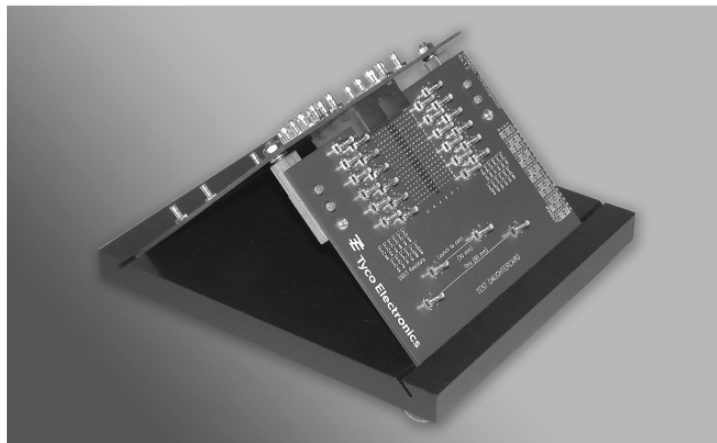

Customer System Evaluation Kit

- System characterization
- Available for loan — contact your local Tyco Electronics Sales Engineer
- Time and frequency domain testable
- Testable to 18+ GHz (25+ Gb/s)
- Multiple calibration options
- Convenient SMA interface



Z-PACK TinMan Orthogonal 6 Pair Midplane Assemblies

**6 Pair 12 Column
Receptacle Assembly**

Part Number 1934633-1

Reference Application
Specification
114-13202

Mates with
Part Number 1934607-1 and
Part Number 1934608-1

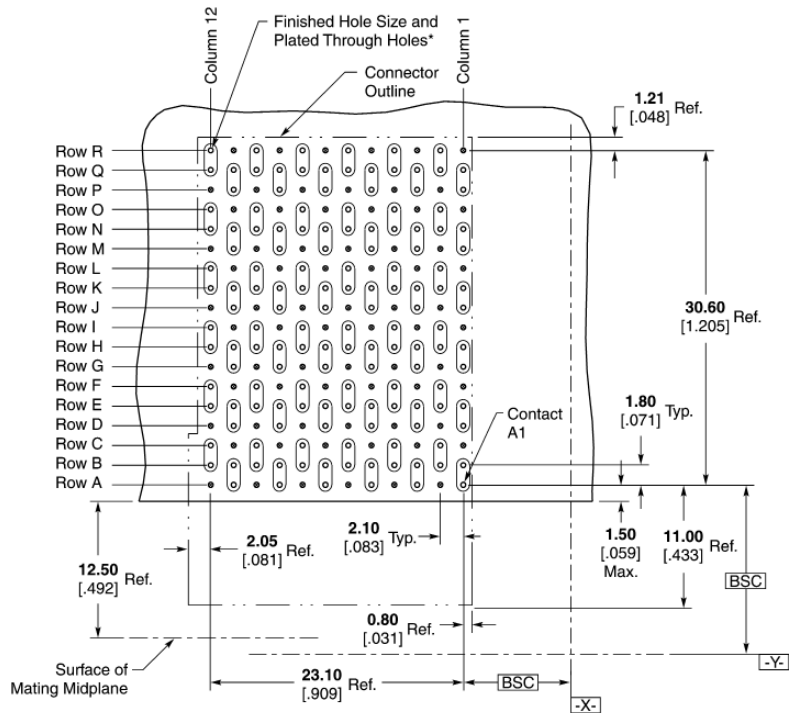
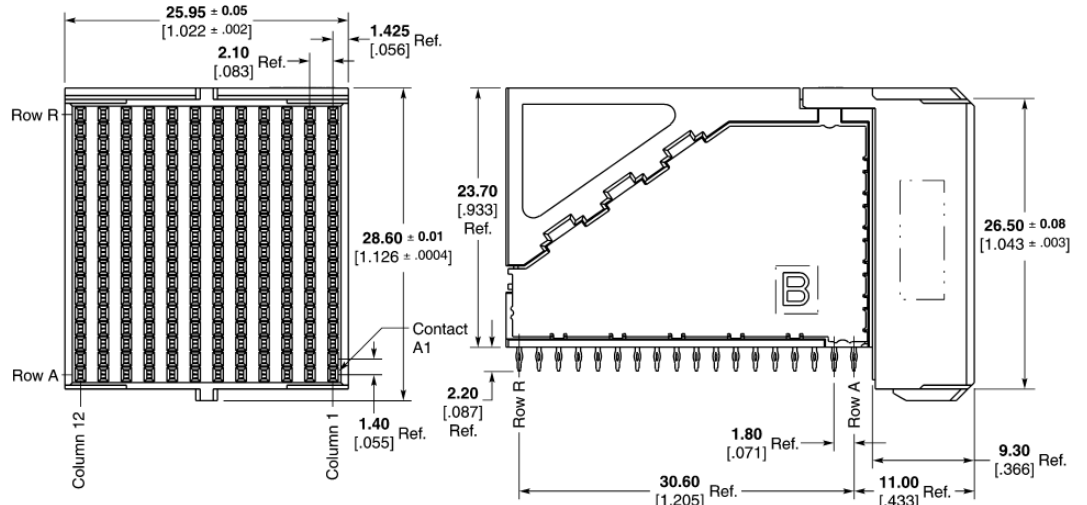

**Recommended PC Board Layout
Component Side Shown**

Note: For additional information on pcb routing guidelines, reference the Z-PACK TinMan Connector Routing Guide Report #27GC001-1.

* Finished Hole Diameter = 0.46 ± 0.05 [.018 ± .002]
Drilled Hole Diameter = 0.55 ± 0.02 [.022 ± .001]
Copper Thickness = 0.038 ± 0.013 [.0015 ± .0005]
Tin-Lead Thickness = 0.008 ± 0.004 [.0003 ± .0002]
Finishes other than Tin-Lead, See Appl. Spec. 114-13202

Note: All part numbers are RoHS compliant. Tin-Lead parts are RoHS compliant through exemption for lead in press-fit connectors.

Z-PACK TinMan Orthogonal 6 Pair Midplane Assemblies (Continued)

**6 Pair 6 Column
Receptacle Assembly A**

Part Number 1934634-1

Reference Application
Specification
114-13202

Mates with
Part Number 1934609-1 and
Part Number 1934610-1

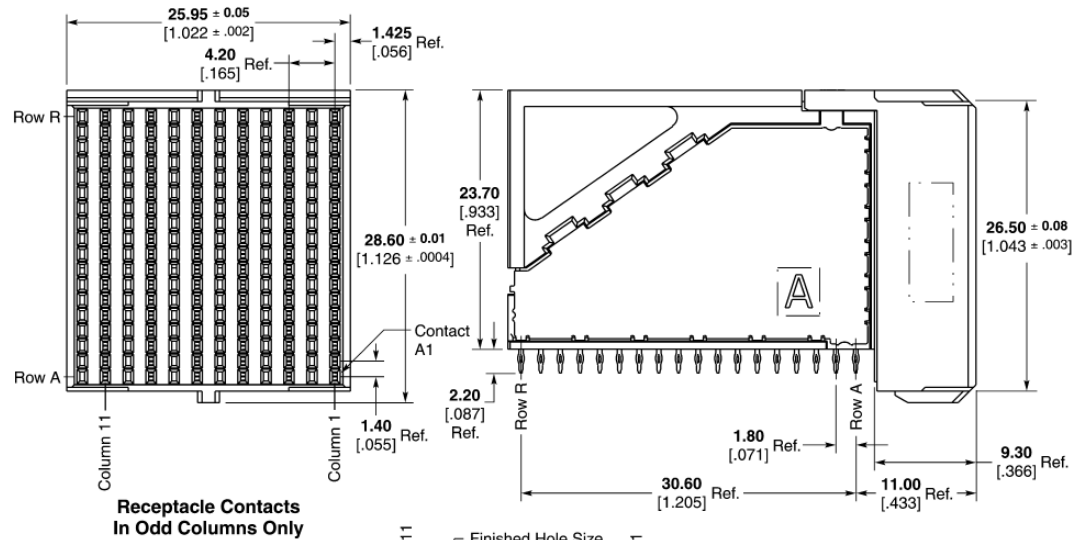

Receptacle Contacts
In Odd Columns Only

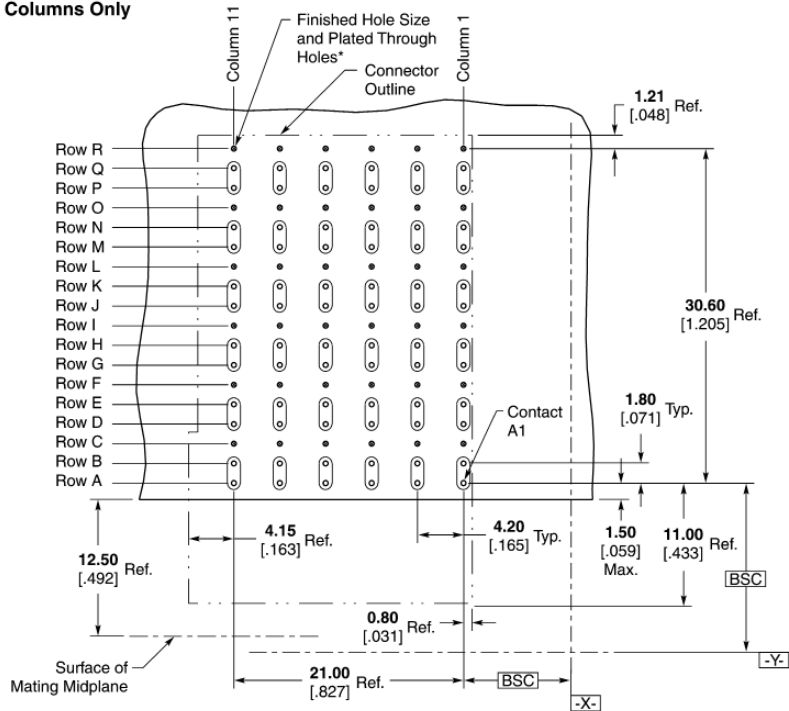

Recommended PC Board Layout
Component Side Shown

Note: For additional information on pcb routing guidelines, reference the Z-PACK TinMan Connector Routing Guide Report #27GC001-1.

* Finished Hole Diameter = 0.46 ± 0.05 [0.018 ± .002]
Drilled Hole Diameter = 0.55 ± 0.02 [0.022 ± .001]
Copper Thickness = 0.038 ± 0.013 [0.0015 ± .0005]
Tin-Lead Thickness = 0.008 ± 0.004 [0.0003 ± .0002]
Finishes other than Tin-Lead, See Appl. Spec. 114-13202

Note: All part numbers are RoHS compliant. Tin-Lead parts are RoHS compliant through exemption for lead in press-fit connectors.

Z-PACK TinMan Orthogonal 6 Pair Midplane Assemblies (Continued)

**6 Pair 6 Column
Receptacle Assembly B**

Part Number 1934760-1

Reference Application
Specification
114-13202

Mates with
Part Number 1934609-1 and
Part Number 1934610-1

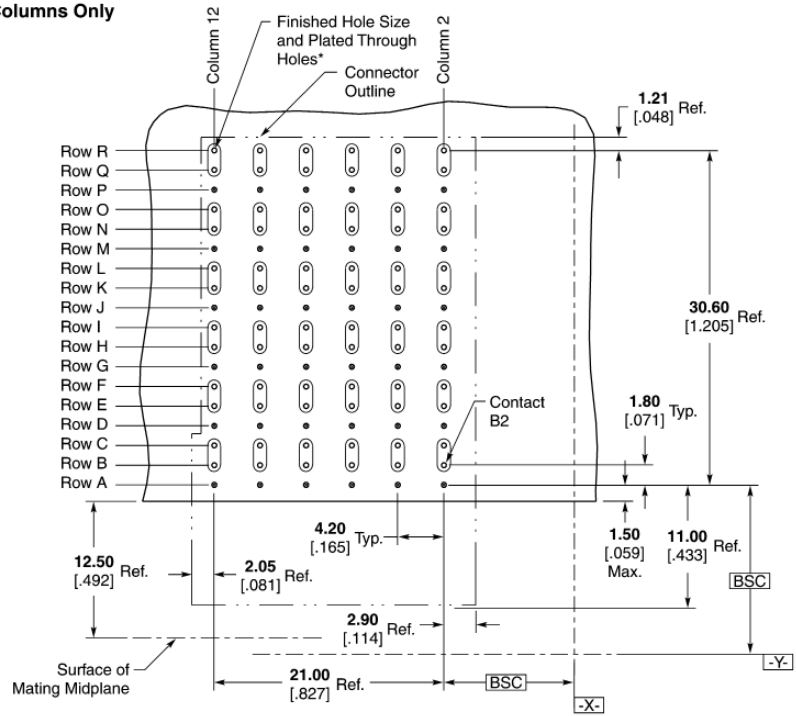
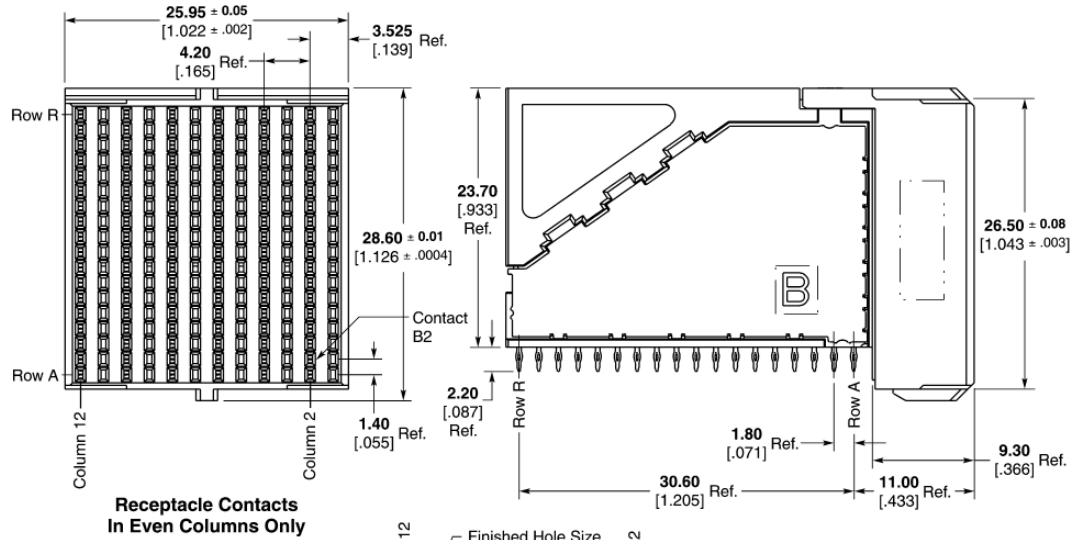

Note: For additional information on pcb routing guidelines, reference the Z-PACK TinMan Connector Routing Guide Report #27GC001-1.

* Finished Hole Diameter = 0.46 ± 0.05 [0.018 ± .002]
 Drilled Hole Diameter = 0.55 ± 0.02 [0.022 ± .001]
 Copper Thickness = 0.038 ± 0.013 [0.0015 ± .0005]
 Tin-Lead Thickness = 0.008 ± 0.004 [0.0003 ± .0002]
 Finishes other than Tin-Lead, See Appl. Spec. 114-13202

Note: All part numbers are RoHS compliant. Tin-Lead parts are RoHS compliant through exemption for lead in press-fit connectors.

Z-PACK TinMan Orthogonal 6 Pair Midplane Assemblies (Continued)

**6 Pair 12 Column
Double Wall
Header Assembly**
Part Number 1934608-1
**Reference Application
Specification
114-13202**
**Mates with
Part Number 1934633-1**

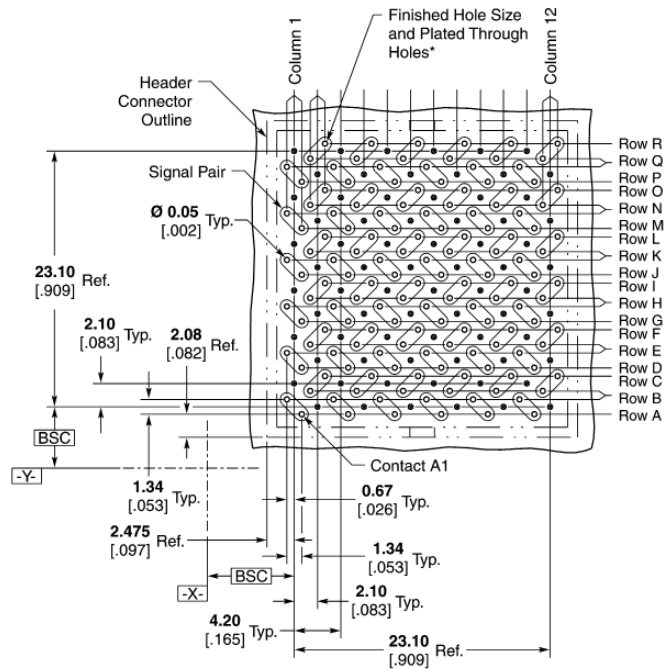
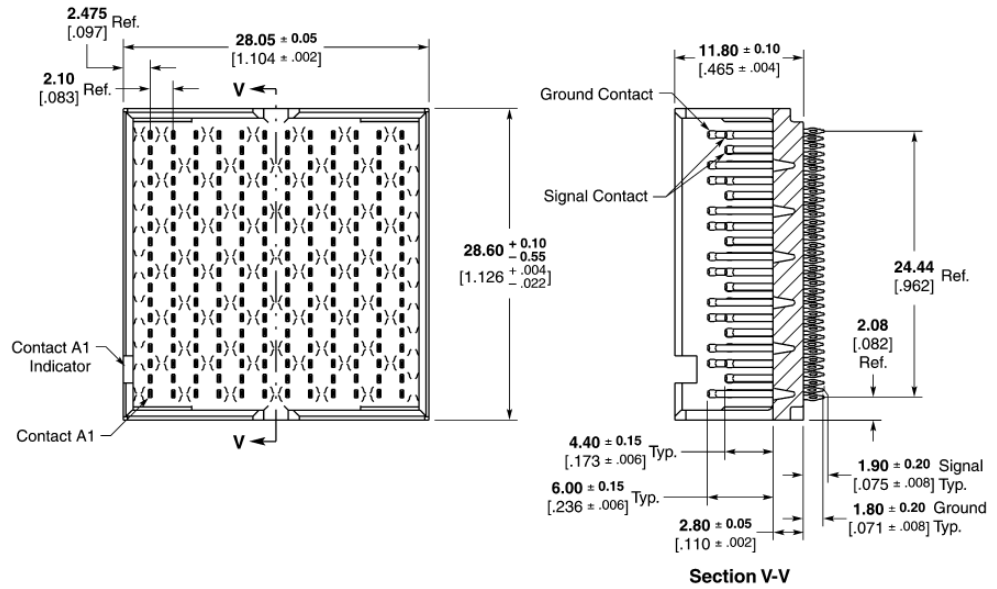

**Recommended PC Board Layout
Component Side Shown**

Note: For additional information on pcb routing guidelines, reference the Z-PACK TinMan Connector Routing Guide Report #27GC001-1.

* Finished Hole Diameter = 0.46 ± 0.05 [0.018 ± 0.002]
 Drilled Hole Diameter = 0.55 ± 0.02 [0.022 ± 0.001]
 Copper Thickness = 0.038 ± 0.013 [0.0015 ± 0.0005]
 Tin-Lead Thickness = 0.008 ± 0.004 [0.0003 ± 0.0002]
 Finishes other than Tin-Lead, See Appl. Spec. 114-13202

Note: All part numbers are RoHS compliant. Tin-Lead parts are RoHS compliant through exemption for lead in press-fit connectors.

Z-PACK TinMan Orthogonal 6 Pair Midplane Assemblies (Continued)

**6 Pair 12 Column
Open Ended
Header Assembly**
Part Number 1934607-1
Reference Application
Specification
114-13202
Mates with
Part Number 1934633-1

1
Z-PACK TinMan High Speed, High Density Backplane Connector

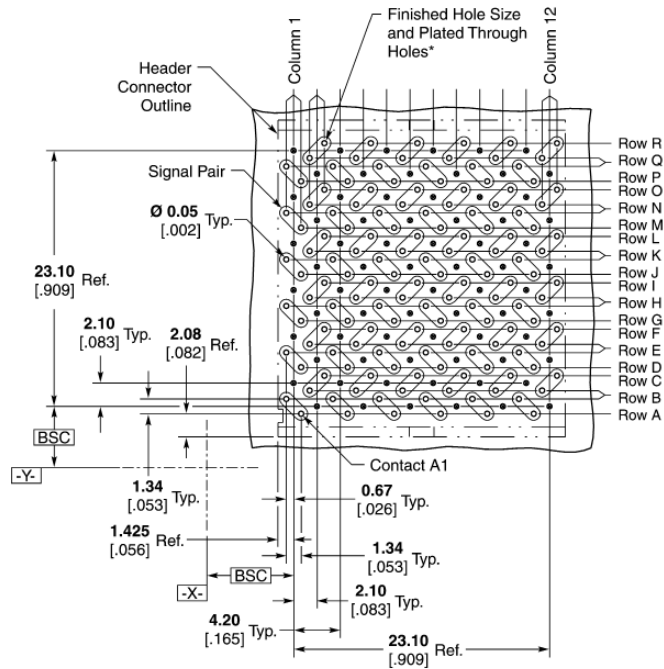
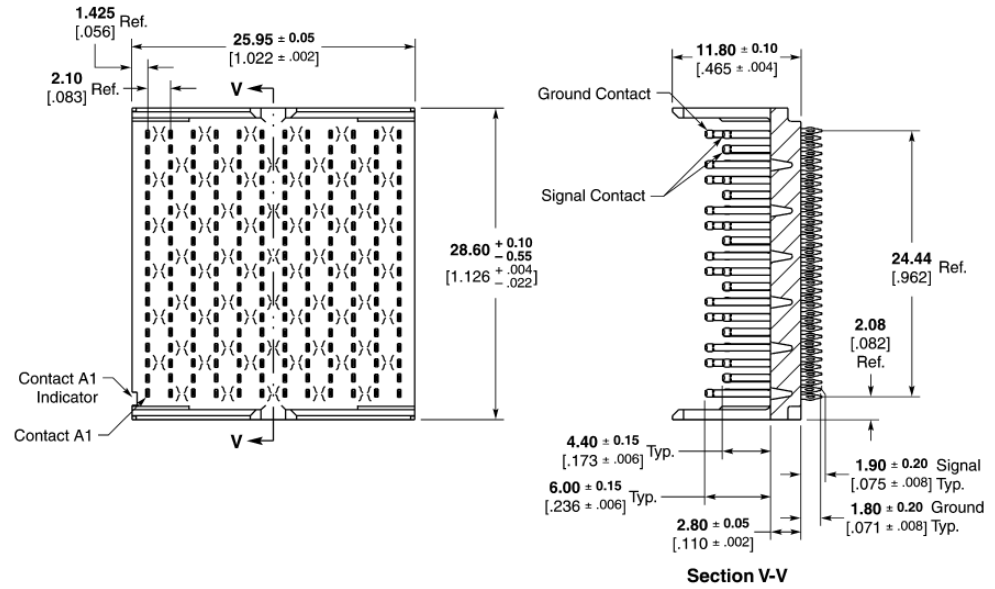

**Recommended PC Board Layout
Component Side Shown**

Note: For additional information on pcb routing guidelines, reference the Z-PACK TinMan Connector Routing Guide Report #27GC001-1.

* Finished Hole Diameter = 0.46 ± 0.05 [0.018 ± .002]
 Drilled Hole Diameter = 0.55 ± 0.02 [0.022 ± .001]
 Copper Thickness = 0.038 ± 0.013 [0.0015 ± .0005]
 Tin-Lead Thickness = 0.008 ± 0.004 [0.0003 ± .0002]
 Finishes other than Tin-Lead, See Appl. Spec. 114-13202

Note: All part numbers are RoHS compliant. Tin-Lead parts are RoHS compliant through exemption for lead in press-fit connectors.

Z-PACK TinMan Orthogonal 6 Pair Midplane Assemblies (Continued)

**6 Pair 6 Column
Open Ended
Header Assembly**

Part Number 1934609-1

**Reference Application
Specification
114-13202**

**Mates with
Part Number 1934634-1 and
Part Number 1934760-1**

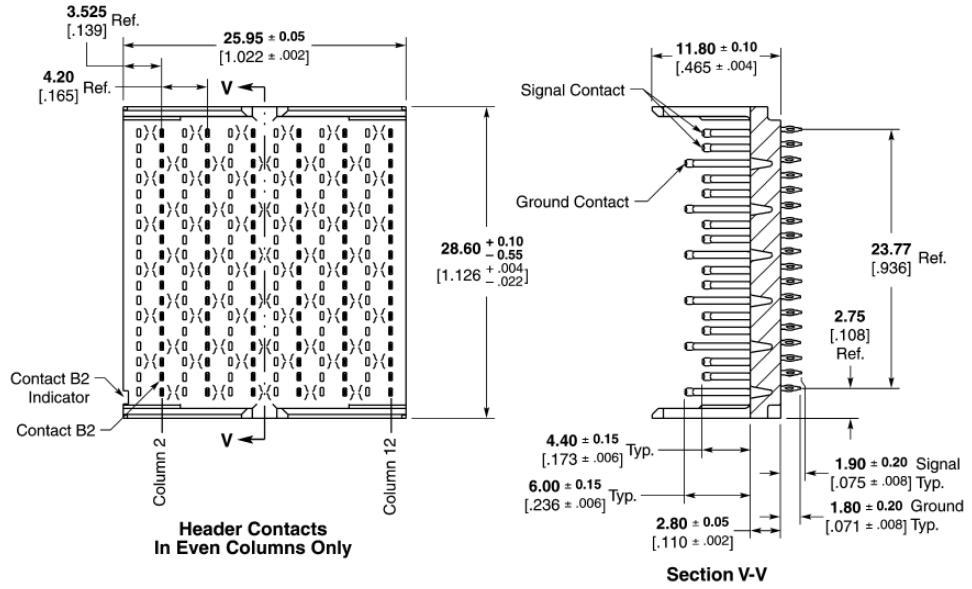

1
Z-PACK TinMan High Speed, High Density Backplane Connector

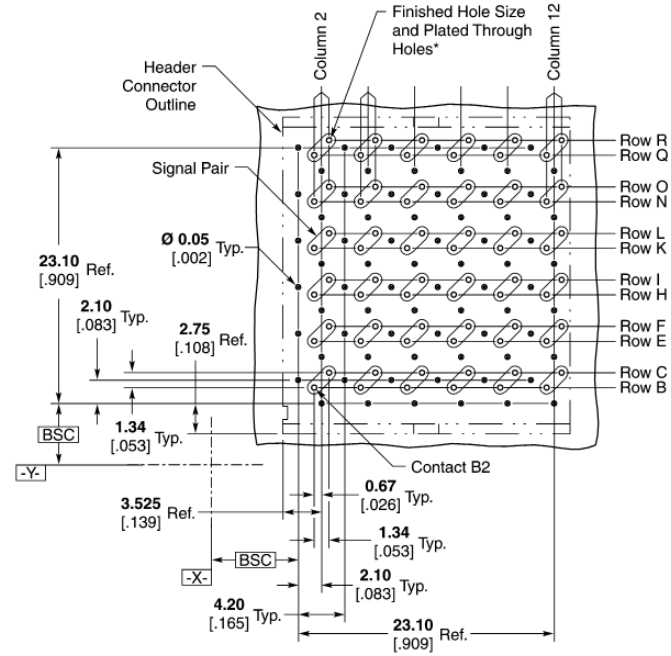

**Recommended PC Board Layout
Component Side Shown**

Note: For additional information on pcb routing guidelines, reference the Z-PACK TinMan Connector Routing Guide Report #27GC001-1.

* Finished Hole Diameter = 0.46 ± 0.05 [.018 ± .002]
 Drilled Hole Diameter = 0.55 ± 0.02 [.022 ± .001]
 Copper Thickness = 0.038 ± 0.013 [.0015 ± .0005]
 Tin-Lead Thickness = 0.008 ± 0.004 [.0003 ± .0002]
 Finishes other than Tin-Lead, See Appl. Spec. 114-13202

Note: All part numbers are RoHS compliant. Tin-Lead parts are RoHS compliant through exemption for lead in press-fit connectors.

Z-PACK TinMan Product Mating Sequence Chart



| Product Family | Dim. C | Dim. A Fully Mated | Contact | Dim B. | | Fully Mated Wipe Length |
|---|--------------|--------------------|---------------------------|---------------|-----------------------|-------------------------|
| | | | | Reliable Mate | First Mate Last Break | |
| Z-PACK HM-Zd Product | 1.50 .059 | 12.50 .492 | Ground Shield | 16.78 [.661] | 17.55 [.691] | 4.28 [.169] |
| | | | Signal Level 2 | 15.41 [.607] | 15.85 [.624] | 2.91 [.115] |
| | | | Signal Level 1 | 13.91 [.548] | 14.35 [.565] | 1.41 [.056] |
| Z-PACK HM-Zd Guide Hardware | 3.00 .118 | 12.50 .492 | 24.0 mm Pin | 27.50 [1.083] | 33.40 [1.315] | N/A |
| | | | 22.2 mm Pin | 25.70 [1.012] | 31.60 [1.244] | N/A |
| | | | Key Blocking Point | N/A | 22.03 [.867] | N/A |
| Z-PACK TinMan Product | 1.50 .059 | 12.50 .492 | Ground Pins | 16.44 [.647] | 17.13 [.674] | 3.94 [.155] |
| | | | Signal Level 2 | 14.94 [.588] | 15.63 [.615] | 2.44 [.096] |
| | | | Signal Level 1 | N/A | N/A | N/A |
| Z-PACK 2mm HM Product | 1.50 .059 | 12.50 .492 | Signal Level 3 | 18.27 [.719] | 18.84 [.742] | 5.77 [.227] |
| | | | Signal Level 2 | 16.77 [.660] | 17.34 [.683] | 4.27 [.168] |
| | | | Signal Level 1 | 15.27 [.601] | 15.84 [.624] | 2.77 [.109] |
| MULTIGIG RT T1 Product | 2.50 .098 | 12.50 .492 | Ground | 18.00 [.709] | — | 5.50 [.217] |
| | | | Signal Level 3 | 18.00 [.709] | — | 5.50 [.217] |
| | | | Signal Level 2 | 16.50 [.650] | — | 4.00 [.157] |
| | | | Signal Level 1 | 15.00 [.591] | — | 2.50 [.098] |
| MULTIGIG RT T2 Product | 2.25 .089 | 12.50 .492 | Ground | 18.00 [.709] | — | 5.50 [.217] |
| | | | Signal Level 3 | 18.00 [.709] | — | 5.50 [.217] |
| | | | Signal Level 2 | 16.50 [.650] | — | 4.00 [.157] |
| MULTIGIG RT Power Module | 5.50 .217 | 12.50 .492 | Power Level 3 | 23.75 [.935] | — | 11.25 [.443] |
| | | | Power Level 2 | 22.25 [.876] | — | 9.75 [.384] |
| | | | Power Level 1 | 20.75 [.817] | — | 8.25 [.325] |
| MULTIGIG RT Guide Hardware | N/A | 12.50 .492 | Guide Pin Key | 33.25 [1.309] | N/A | 20.75 [.817] |
| | | | Guide ESD Contact | 30.75 [1.211] | — | 18.25 [.719] |
| Z-PACK HS3 Product | 1.50 .059 | 12.50 .492 | Ground | 17.08 [.672] | 17.60 [.693] | 4.78 [.188] |
| | | | Signal Level 2 | 16.05 [.632] | 16.47 [.648] | 3.75 [.148] |
| | | | Signal Level 1 | 14.55 [.573] | 14.97 [.589] | 2.25 [.089] |
| UPM | 3.50 .138 | 12.50 .492 | Power Level 3 | 20.25 [.797] | 20.95 [.825] | 8.10 [.319] |
| | | | Power Level 2 | 18.65 [.734] | 19.35 [.762] | 6.50 [.256] |
| | | | Power Level 1 | 17.03 [.670] | 17.73 [.698] | 4.88 [.192] |
| UPM Guide Hardware | 5.75 .226 | 12.50 .492 | Guide Pin Key | 31.39 [1.236] | 36.16 [1.424] | N/A |
| | | | Keyed Guide Pin | 31.39 [1.236] | 36.16 [1.424] | N/A |
| | | | Keyed Guide Pin | 35.23 [1.387] | 40.00 [1.575] | N/A |
| MULTI-BEAM XL Right Angle Header to Vertical Receptacle | 5.08 .200 | 14.73 .580 | PreMate Power — Level 1 | — | 16.84 [.663] | 5.61 [.221] Min. |
| | | | PostMate Power — Level 2 | — | 17.81 [.701] | 4.34 [.171] Min. |
| | | | PreMate Signal — Level 2 | — | 18.26 [.719] | 3.81 [.150] Min. |
| | | | PostMate Signal — Level 3 | — | 19.53 [.769] | 2.54 [.100] Min. |
| MULTI-BEAM XL Right Angle Receptacle to Vertical Header | 3.81 .150 | 13.21 .520 | PreMate Power — Level 1 | — | 15.32 [.603] | 5.61 [.221] Min. |
| | | | PostMate Power — Level 2 | — | 16.28 [.641] | 4.34 [.171] Min. |
| | | | PreMate Signal — Level 2 | — | 16.74 [.659] | 3.81 [.150] Min. |
| | | | PostMate Signal — Level 3 | — | 18.01 [.709] | 2.54 [.100] Min. |

Table of Contents

Z-PACK Slim UHD Connector 47-54
 Product Line Overview 48
 Connector Concept 49
 Flexibility 49
 Upgradeability 50
 Connector Footprint 50
 Typical Electrical Properties 51
 Female and Male Connectors 52
 Right-Angle Male (RAM) Connector 53
 Power Connector 53
 Guide Pins and Guide Module 54

2
Z-PACK Slim UHD Connector

Z-PACK Slim UHD Connectors

Product Facts

- Density of 55 pins/cm²
- Fits +13 mm slot pitches
- 20+ Gbps scalable signal speed
- Complete end-to-end stackable
- Press-fit termination technology
- Different pin assignments possible
- Post/Premating possible
- Integrated polarization & guiding

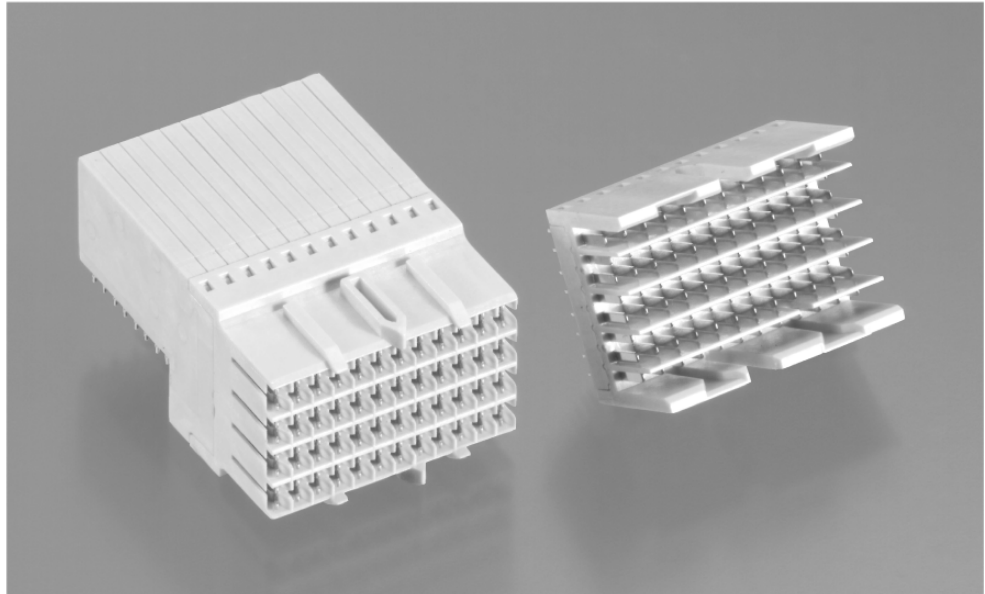

Z-PACK Slim (low profile) UHD (Ultra High Density) is a flexible and upgradeable connector system designed to fit 15 mm (0.6 inch) slot pitch applications.

The Z-PACK Slim UHD connector has an extremely high contact density combined with excellent high speed signal performance.

For more Information:
<http://www.zpackuhd.com>

Applications

- Telecom Equipment
- Switches
- Routers
- Servers, etc.



**Стандарт
Электрон
Связь**

Мы молодая и активно развивающаяся компания в области поставок электронных компонентов. Мы поставляем электронные компоненты отечественного и импортного производства напрямую от производителей и с крупнейших складов мира.

Благодаря сотрудничеству с мировыми поставщиками мы осуществляем комплексные и плановые поставки широчайшего спектра электронных компонентов.

Собственная эффективная логистика и склад в обеспечивает надежную поставку продукции в точно указанные сроки по всей России.

Мы осуществляем техническую поддержку нашим клиентам и предпродажную проверку качества продукции. На все поставляемые продукты мы предоставляем гарантию .

Осуществляем поставки продукции под контролем ВП МО РФ на предприятия военно-промышленного комплекса России , а также работаем в рамках 275 ФЗ с открытием отдельных счетов в уполномоченном банке. Система менеджмента качества компании соответствует требованиям ГОСТ ISO 9001.

Минимальные сроки поставки, гибкие цены, неограниченный ассортимент и индивидуальный подход к клиентам являются основой для выстраивания долгосрочного и эффективного сотрудничества с предприятиями радиоэлектронной промышленности, предприятиями ВПК и научно-исследовательскими институтами России.

С нами вы становитесь еще успешнее!

Наши контакты:

Телефон: +7 812 627 14 35

Электронная почта: sales@st-electron.ru

Адрес: 198099, Санкт-Петербург,
Промышленная ул, дом № 19, литера Н,
помещение 100-Н Офис 331