

Optocoupler, Phototransistor Output (Single, Dual, Quad Channel)

Single Channel

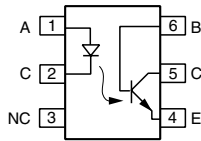

Dual Channel

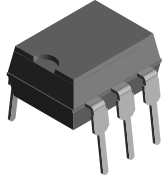
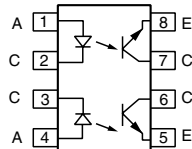
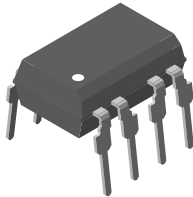

Quad Channel

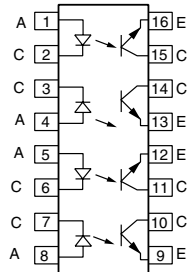
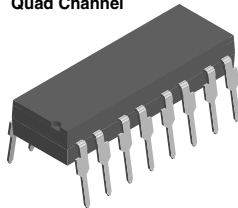

1179015

FEATURES

- IL74/ILD74/ILQ74 TTL compatible
- Transfer ratio, 35 % typical
- Coupling capacitance, 0.5 pF
- Single, dual, and quad channel
- Industry standard DIP packages
- Lead (Pb)-free component
- Component in accordance to RoHS 2002/95/EC and WEEE 2002/96/EC



RoHS
COMPLIANT

AGENCY APPROVALS

- UL1577, file no. E52744 system code H or J, double protection
- CSA 93751
- BSI IEC 60950; IEC 60065
- DIN EN 60747-5-2 (VDE 0884)/DIN EN 60747-5-5 pending available with option 1, X001 suffix
- FIMKO

DESCRIPTION

The IL74/ILD74/ILQ74 is an optically coupled pair with a GaAlAs infrared LED and a silicon NPN phototransistor. Signal information, including a DC level, can be transmitted by the device while maintaining a high degree of electrical isolation between input and output. The IL74/ILD74/ILQ74 is especially for driving medium-speed logic, where it may be used to eliminate troublesome ground loop and noise problems. Also it can be used to replace relays and transformers in many digital interface applications, as well as analog applications such as CTR modulation.

The ILD74 has two isolated channels in a single DIP package; the ILQ74 has four isolated channels per package.

ORDER INFORMATION	
PART	REMARKS
IL74	CTR _{DC} > 12.5 %, single channel DIP-6
ILD74	CTR _{DC} > 12.5 %, dual channel DIP-8
ILQ74	CTR _{DC} > 12.5 %, quad channel DIP-16
IL74-X006	CTR _{DC} > 12.5 %, single channel DIP-6 400 mil (option 6)
ILD74-X006	CTR _{DC} > 12.5 %, dual channel DIP-8 400 mil (option 6)
ILD74-X007	CTR _{DC} > 12.5 %, dual channel SMD-8 (option 7)
ILD74-X009	CTR _{DC} > 12.5 %, dual channel SMD-8 (option 9)
ILQ74-X009	CTR _{DC} > 12.5 %, dual channel SMD-16 (option 9)

Note

For additional information on the available options refer to option information.



ABSOLUTE MAXIMUM RATINGS					
PARAMETER	TEST CONDITION	PART	SYMBOL	VALUE	UNIT
INPUT					
Peak reverse voltage			V_R	3.0	V
Forward continuous current			I_F	60	mA
Power dissipation			P_{diss}	100	mW
Derate linearly from 55 %				1.33	mW/°C
OUTPUT					
Collector emitter breakdown voltage			BV_{CEO}	20	V
Emitter collector breakdown voltage			BV_{ECO}	5.0	V
Collector base breakdown voltage			BV_{CBO}	70	V
Power dissipation			P_{diss}	150	mW
Derate linearly from 25 °C				2.0	mW/°C
COUPLER					
Isolation test voltage	$t = 1.0 \text{ s}$		V_{ISO}	5300	V_{RMS}
Isolation resistance	$V_{IO} = 500 \text{ V}, T_{amb} = 25 \text{ °C}$		R_{IO}	$\geq 10^{12}$	Ω
	$V_{IO} = 500 \text{ V}, T_{amb} = 100 \text{ °C}$		R_{IO}	$\geq 10^{11}$	Ω
Total package dissipation		IL74	P_{tot}	200	mW
		ILD74	P_{tot}	400	mW
		ILQ74	P_{tot}	500	mW
Derate linearly from 25 °C		IL74		2.7	mW/°C
		ILD74		5.33	mW/°C
		ILQ74		6.67	mW/°C
Creepage distance				≥ 7.0	mm
Clearance distance				≥ 7.0	mm
Storage temperature			T_{stg}	- 55 to + 150	°C
Operating temperature			T_{amb}	- 55 to + 100	°C
Lead soldering time at 260 °C				10	s

Note

$T_{amb} = 25 \text{ °C}$, unless otherwise specified.

Stresses in excess of the absolute maximum ratings can cause permanent damage to the device. Functional operation of the device is not implied at these or any other conditions in excess of those given in the operational sections of this document. Exposure to absolute maximum ratings for extended periods of the time can adversely affect reliability.

ELECTRICAL CHARACTERISTICS						
PARAMETER	TEST CONDITION	SYMBOL	MIN.	TYP.	MAX.	UNIT
INPUT						
Forward voltage	$I_F = 20 \text{ mA}$	V_F		1.3	1.5	V
Reverse current	$V_R = 3.0 \text{ V}$	I_R		0.1	100	μA
Capacitance	$V_R = 0 \text{ V}$	C_O		25		pF
OUTPUT						
Collector emitter breakdown voltage	$I_C = 1.0 \text{ mA}$	BV_{CEO}	20	50		V
Collector emitter leakage current	$V_{CE} = 5.0 \text{ V}, I_F = 0 \text{ A}$	I_{CEO}		5.0	500	nA
Capacitance collector emitter	$V_{CE} = 0 \text{ V}, f = 1.0 \text{ Hz}$	C_{CE}		10		pF
COUPLER						
Saturation voltage, collector emitter	$I_C = 2.0 \text{ mA}, I_F = 16 \text{ mA}$	V_{CEsat}		0.3	0.5	V
Resistance (input to output)		R_{IO}		100		$G\Omega$
Capacitance (input to output)		C_{IO}		0.5		pF

Note

$T_{amb} = 25 \text{ °C}$, unless otherwise specified.

Minimum and maximum values are testing requirements. Typical values are characteristics of the device and are the result of engineering evaluation. Typical values are for information only and are not part of the testing requirements.



CURRENT TRANSFER RATIO						
PARAMETER	TEST CONDITION	SYMBOL	MIN.	TYP.	MAX.	UNIT
DC current transfer ratio	$I_F = 16 \text{ mA}$, $V_{CE} = 5.0 \text{ V}$	CTR_{DC}	12.5	35		%

SWITCHING CHARACTERISTICS						
PARAMETER	TEST CONDITION	SYMBOL	MIN.	TYP.	MAX.	UNIT
Switching times	$R_L = 100 \Omega$, $V_{CE} = 10 \text{ V}$, $I_C = 2.0 \text{ mA}$	t_{on} , t_{off}		3.0		μs

TYPICAL CHARACTERISTICS

$T_{amb} = 25 \text{ }^\circ\text{C}$, unless otherwise specified

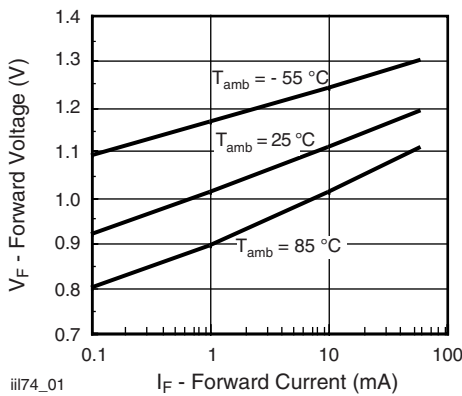

iii74_01

Fig. 1 - Forward Voltage vs. Forward Current

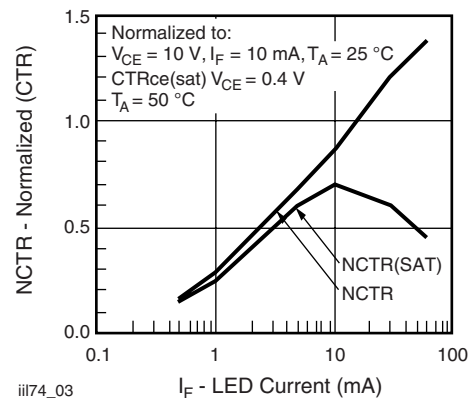

iii74_03

Fig. 3 - Normalized Non-Saturated and Saturated CTR vs. LED Current

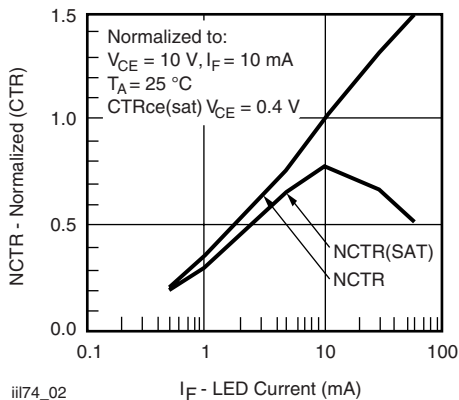

iii74_02

Fig. 2 - Normalized Non-Saturated and Saturated CTR vs. LED Current

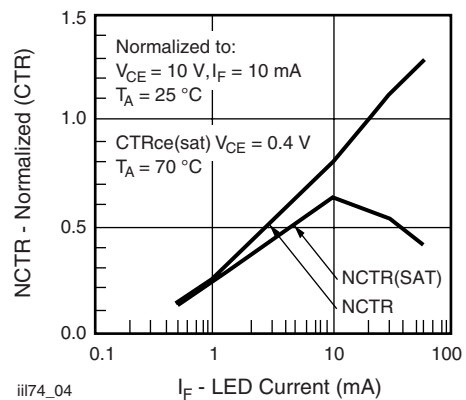

iii74_04

Fig. 4 - Normalized Non-Saturated and Saturated CTR vs. LED Current

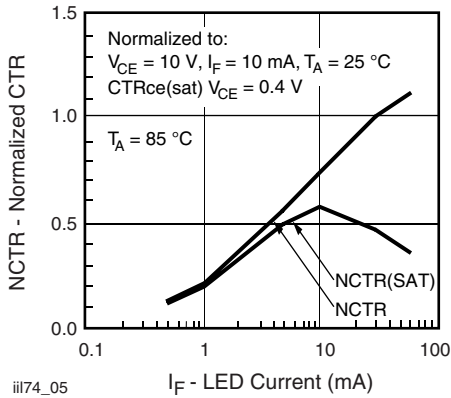

Fig. 5 - Normalized Non-Saturated and Saturated CTR vs. LED Current

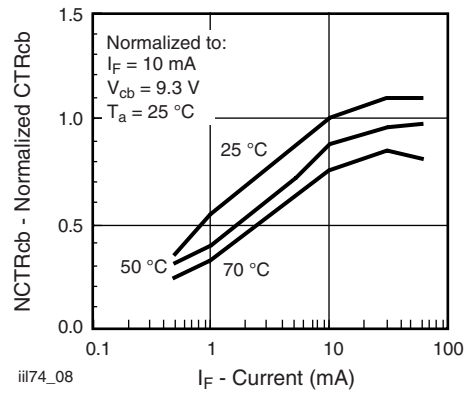

Fig. 8 - Normalized CTR_{cb} vs. LED Current and Temperature

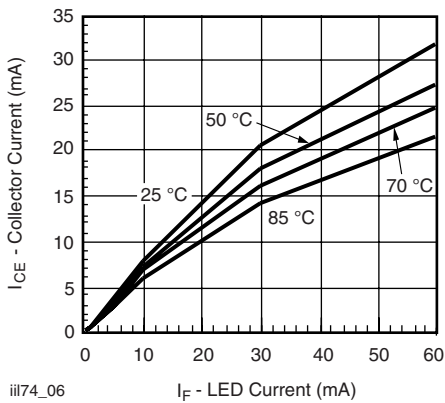

Fig. 6 - Collector Emitter Current vs. Temperature and LED Current

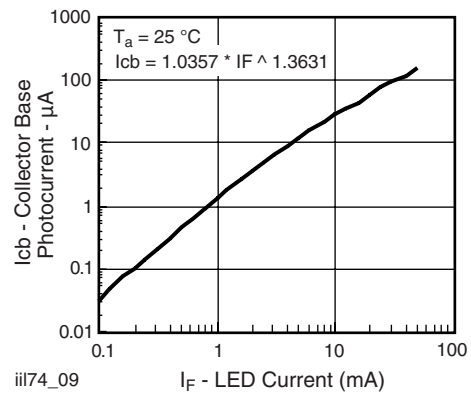

Fig. 9 - Collector Base Photocurrent vs. LED Current

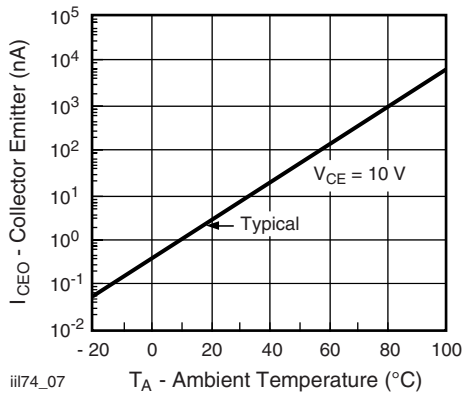

Fig. 7 - Collector Emitter Leakage Current vs. Temperature

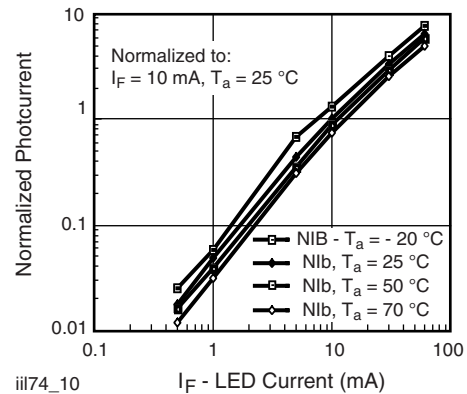

Fig. 10 - Normalized Photocurrent vs. I_F and Temperature

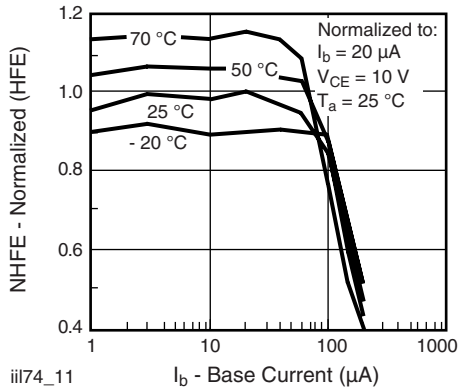
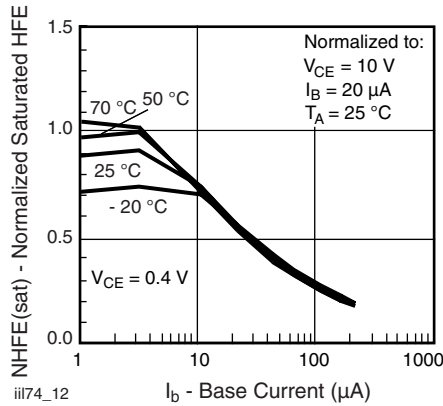
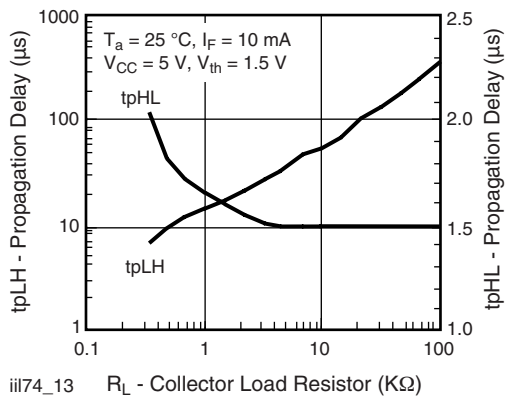

 Fig. 11 - Normalized Non-Saturated h_{FE} vs. Base Current and Temperature

 Fig. 12 - Normalized Saturated h_{FE} vs. Base Current and Temperature

Fig. 13 - Propagation Delay vs. Collector Load Resistor

IL74/ILD74/ILQ74



Vishay Semiconductors

Optocoupler, Phototransistor Output
(Single, Dual, Quad Channel)

PACKAGE DIMENSIONS in inches (millimeters)

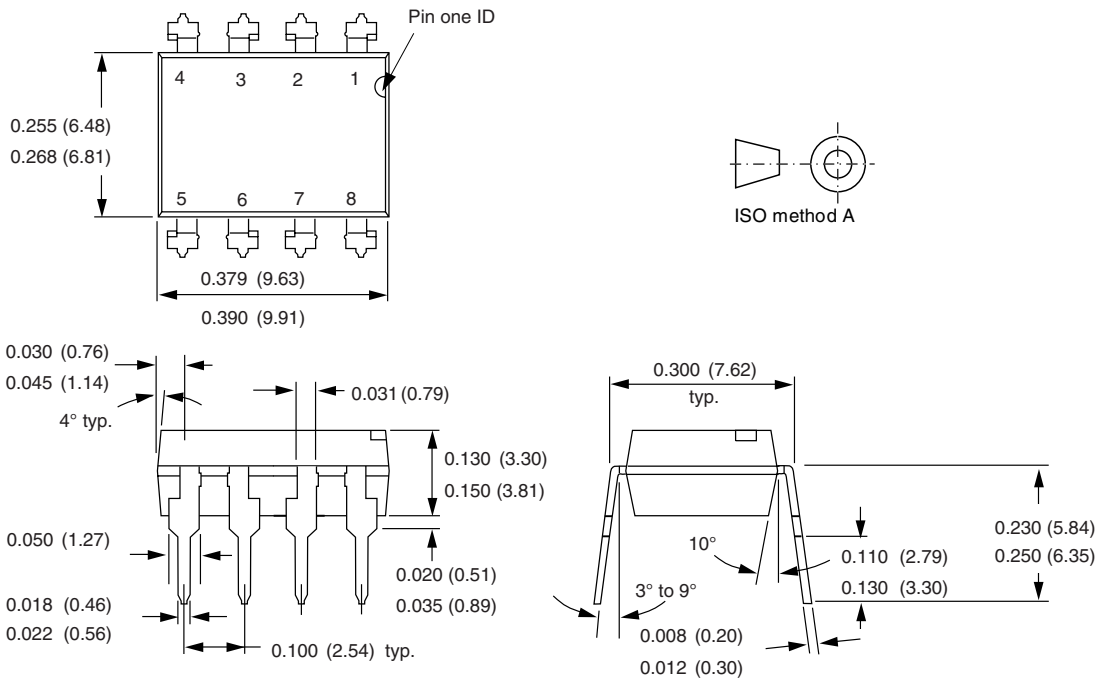
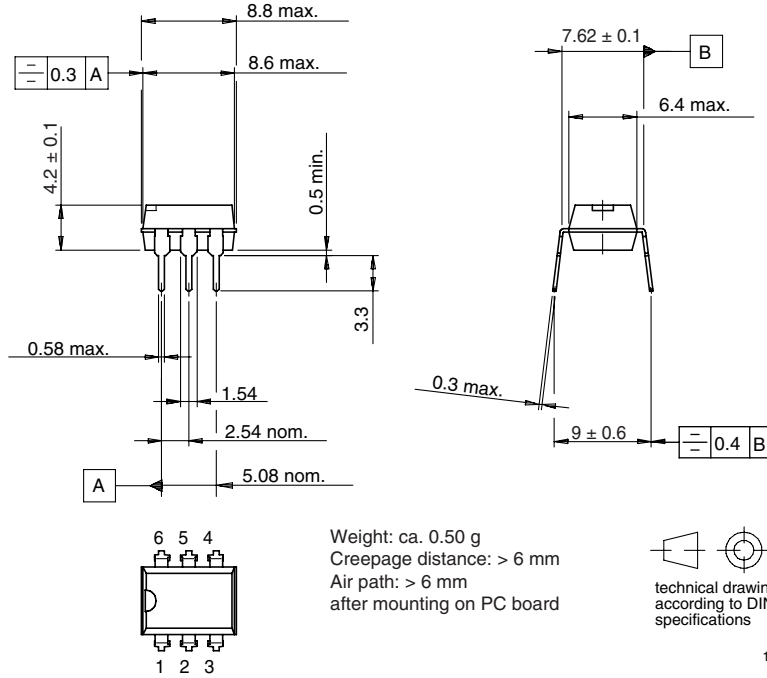

i178006



Optocoupler, Phototransistor Output (Single, Dual, Quad Channel)

IL74/ILD74/ILQ74 Vishay Semiconductors

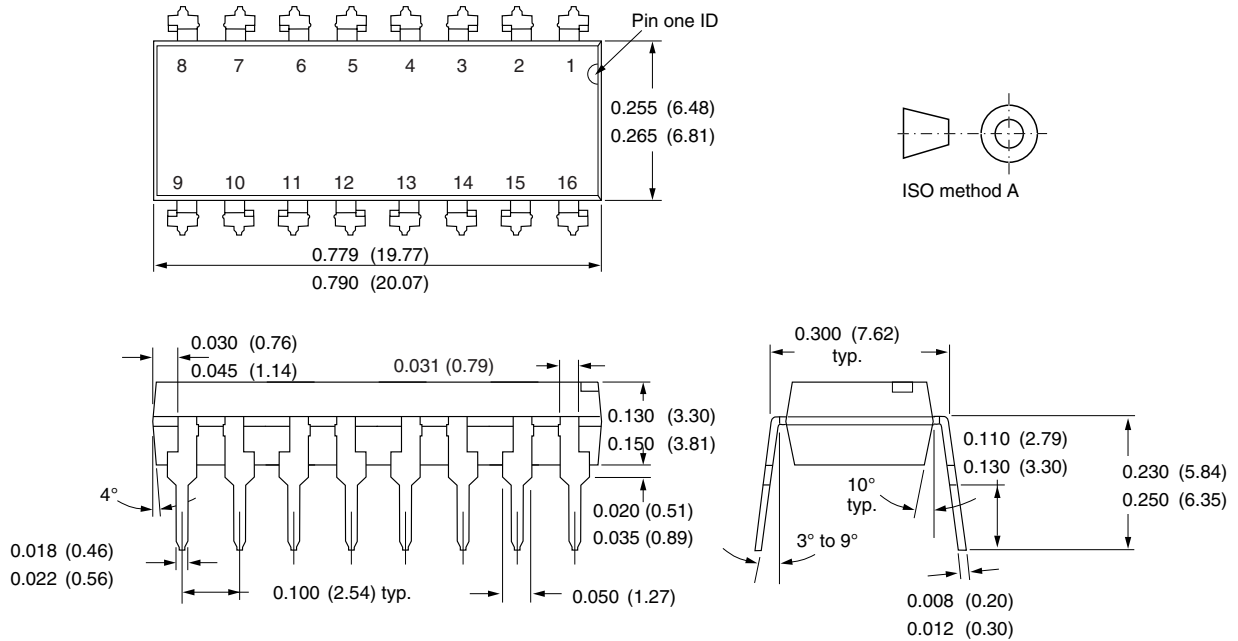

i178007

Option 6

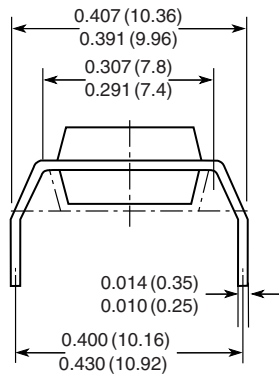

Option 7

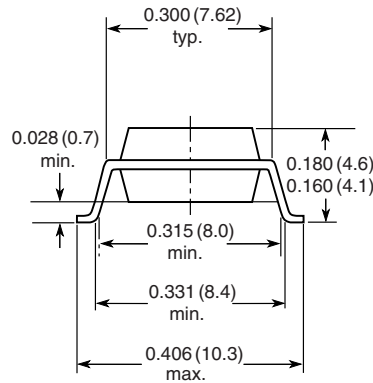

Option 9

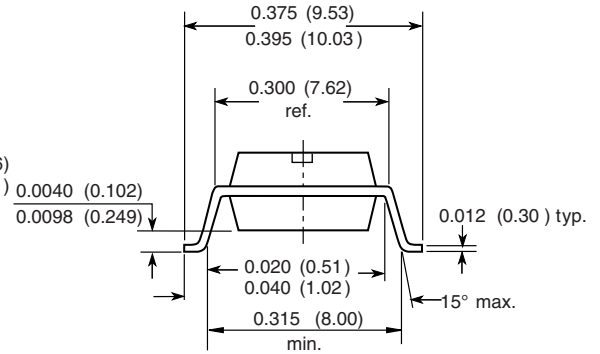

18450

OZONE DEPLETING SUBSTANCES POLICY STATEMENT

It is the policy of Vishay Semiconductor GmbH to

1. Meet all present and future national and international statutory requirements.
2. Regularly and continuously improve the performance of our products, processes, distribution and operating systems with respect to their impact on the health and safety of our employees and the public, as well as their impact on the environment.

It is particular concern to control or eliminate releases of those substances into the atmosphere which are known as ozone depleting substances (ODSs).

The Montreal Protocol (1987) and its London Amendments (1990) intend to severely restrict the use of ODSs and forbid their use within the next ten years. Various national and international initiatives are pressing for an earlier ban on these substances.

Vishay Semiconductor GmbH has been able to use its policy of continuous improvements to eliminate the use of ODSs listed in the following documents.

1. Annex A, B and list of transitional substances of the Montreal Protocol and the London Amendments respectively.
2. Class I and II ozone depleting substances in the Clean Air Act Amendments of 1990 by the Environmental Protection Agency (EPA) in the USA.
3. Council Decision 88/540/EEC and 91/690/EEC Annex A, B and C (transitional substances) respectively.

Vishay Semiconductor GmbH can certify that our semiconductors are not manufactured with ozone depleting substances and do not contain such substances.

We reserve the right to make changes to improve technical design
and may do so without further notice.

Parameters can vary in different applications. All operating parameters must be validated for each customer application by the customer. Should the buyer use Vishay Semiconductors products for any unintended or unauthorized application, the buyer shall indemnify Vishay Semiconductors against all claims, costs, damages, and expenses, arising out of, directly or indirectly, any claim of personal damage, injury or death associated with such unintended or unauthorized use.

Vishay Semiconductor GmbH, P.O.B. 3535, D-74025 Heilbronn, Germany



Disclaimer

All product specifications and data are subject to change without notice.

Vishay Intertechnology, Inc., its affiliates, agents, and employees, and all persons acting on its or their behalf (collectively, "Vishay"), disclaim any and all liability for any errors, inaccuracies or incompleteness contained herein or in any other disclosure relating to any product.

Vishay disclaims any and all liability arising out of the use or application of any product described herein or of any information provided herein to the maximum extent permitted by law. The product specifications do not expand or otherwise modify Vishay's terms and conditions of purchase, including but not limited to the warranty expressed therein, which apply to these products.

No license, express or implied, by estoppel or otherwise, to any intellectual property rights is granted by this document or by any conduct of Vishay.

The products shown herein are not designed for use in medical, life-saving, or life-sustaining applications unless otherwise expressly indicated. Customers using or selling Vishay products not expressly indicated for use in such applications do so entirely at their own risk and agree to fully indemnify Vishay for any damages arising or resulting from such use or sale. Please contact authorized Vishay personnel to obtain written terms and conditions regarding products designed for such applications.

Product names and markings noted herein may be trademarks of their respective owners.



Стандарт Электрон Связь

Мы молодая и активно развивающаяся компания в области поставок электронных компонентов. Мы поставляем электронные компоненты отечественного и импортного производства напрямую от производителей и с крупнейших складов мира.

Благодаря сотрудничеству с мировыми поставщиками мы осуществляем комплексные и плановые поставки широчайшего спектра электронных компонентов.

Собственная эффективная логистика и склад в обеспечивает надежную поставку продукции в точно указанные сроки по всей России.

Мы осуществляем техническую поддержку нашим клиентам и предпродажную проверку качества продукции. На все поставляемые продукты мы предоставляем гарантию .

Осуществляем поставки продукции под контролем ВП МО РФ на предприятия военно-промышленного комплекса России , а также работаем в рамках 275 ФЗ с открытием отдельных счетов в уполномоченном банке. Система менеджмента качества компании соответствует требованиям ГОСТ ISO 9001.

Минимальные сроки поставки, гибкие цены, неограниченный ассортимент и индивидуальный подход к клиентам являются основой для выстраивания долгосрочного и эффективного сотрудничества с предприятиями радиоэлектронной промышленности, предприятиями ВПК и научно-исследовательскими институтами России.

С нами вы становитесь еще успешнее!

Наши контакты:

Телефон: +7 812 627 14 35

Электронная почта: sales@st-electron.ru

Адрес: 198099, Санкт-Петербург,
Промышленная ул, дом № 19, литера Н,
помещение 100-Н Офис 331