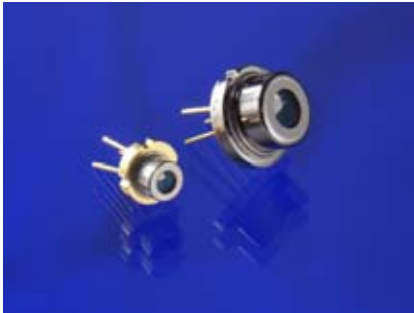

Diode Lasers, High Brightness 0.6 to 8.5 W, 8xx nm 24xx Series

**Key Features**

- 35 – 200 μm apertures available
- High-efficiency, MOCVD quantum well design
- Open heat sink packages and encapsulated devices
- High reliability

The 24xx series diode lasers represent a breakthrough in high continuous wave (CW) optical power and ultra high brightness with unsurpassed reliability. The small emitting aperture, combined with low beam divergence, makes the 24xx series the highest brightness family of CW diode lasers available in the industry.

The 24xx series consists of partially coherent broad-area emitters, with relatively uniform emission over the emitting aperture. Operation is multi-longitudinal mode with a spectral envelope width of approximately 2 nm full width half maximum (FWHM). The far field beam divergence in the plane perpendicular to the P/N junction is nearly Gaussian, while the lateral beam profile exhibits a multiple-transverse mode pattern typical of broad-area emitters. The 24xx series offer up to 8.5 W of output from a 200 μm aperture.

The high efficiency of the quantum well structure, combined with low thermal resistance epi-down chip mounting, provides minimum junction temperature at high optical power. Low junction temperature and low thermal resistance packages extend lifetime and increase reliability.

These diodes are mounted on conventional open heat sink packages and encapsulated devices, allowing for easy integration into user systems.

Applications

- Solid-state laser pumping
- Medical/ophthalmic applications
- Free-space communication
- Beacons/illumination

2

Dimensions Diagram

(Specifications in inches [mm] unless otherwise noted.)

Standard Tolerances
 inches: x.xx = ±0.02
 x.xxx = ±0.010

mm: x.x = ±0.5
 x.xx = ±0.25

Package Style: Open Heat Sink (A)

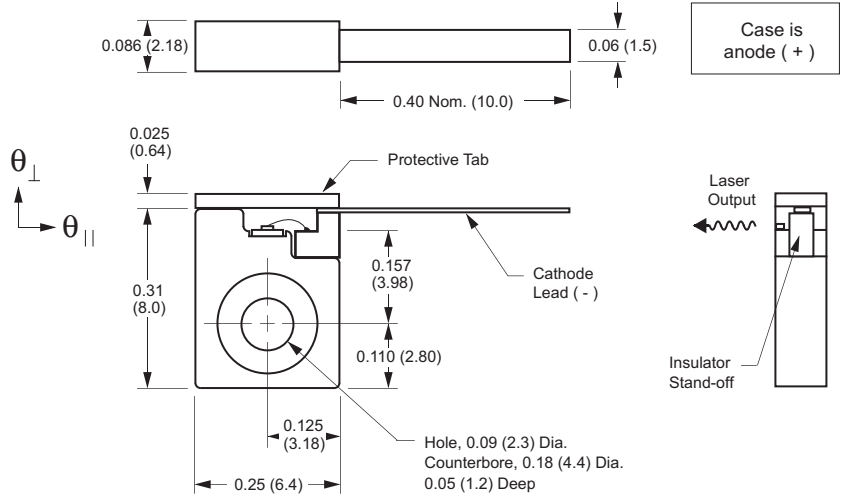

Package Style: SOT-148 Window (G1)

Pinout

Pin Description

Pin	Description
1	Laser cathode (-)
2	Laser anode, MPD cathode and case ground
3	Monitor photodiode anode (+)

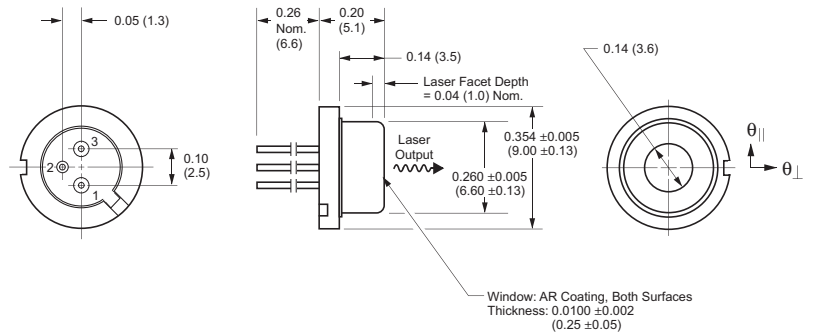

3

Dimensions Diagram

(Specifications in inches [mm] unless otherwise noted.)

Standard Tolerances

inches: x.xx = ±0.02
x.xxx = ±0.010

mm: x.x = ±0.5
x.xx = ±0.25

Package Style: TO-56 Window (J1)

Pinout

Pin	Description
1	Laser cathode (-)
2	Laser anode, MPD cathode and case ground
3	Monitor photodiode anode (+)

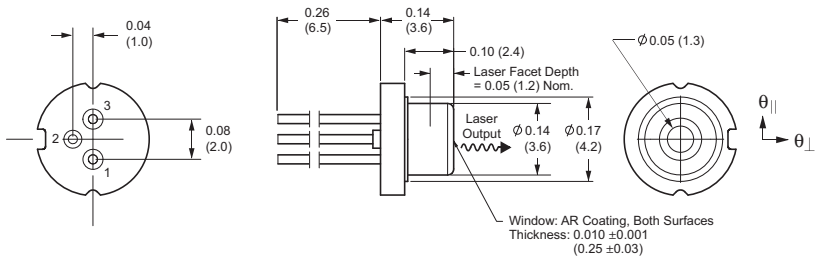

Package Style: Open Heat Sink (Y)

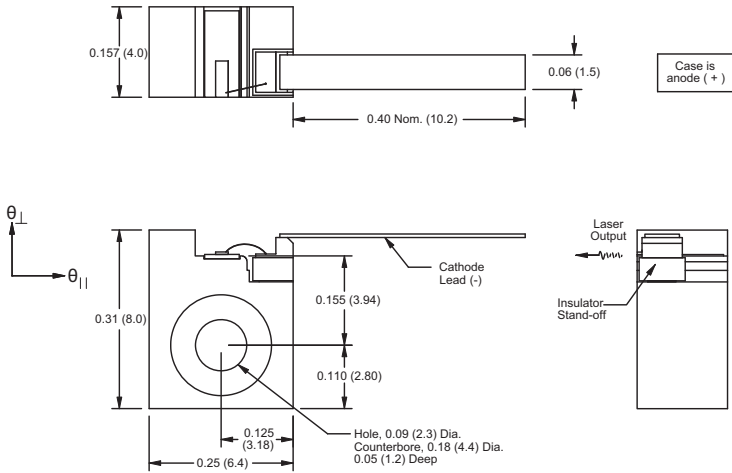

4

Dimensions Diagram

(Specifications in mm unless otherwise noted.)

Standard Tolerances
 mm: x.x = ± 0.5
 x.xx = ± 0.25

Package Style: LX Submount

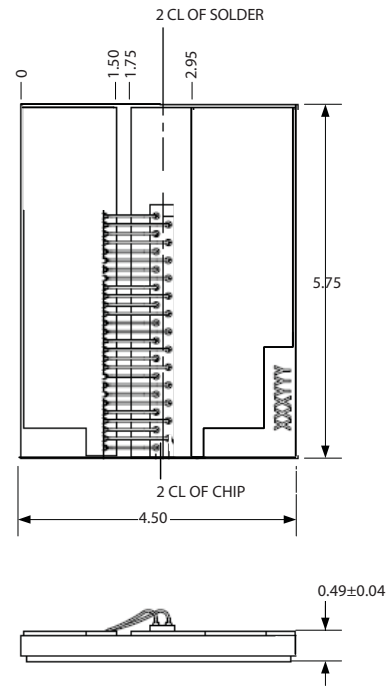
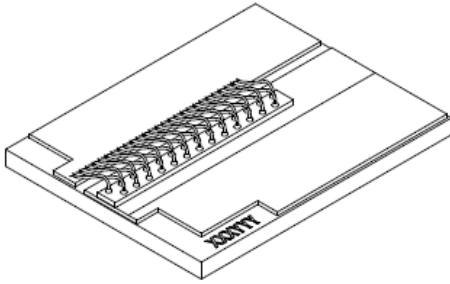

5

Available Configurations	2445 Series G-package	2455 series G-package A-block	2465 Series A-block	2475 Series A-block	2495 Series Y-block	2496 Series Y-block LX submount
---------------------------------	---------------------------------	--	-------------------------------	-------------------------------	-------------------------------	--

Electro-optical Specifications

Parameter	Symbol	2445-G1 0.6 W			2455-G1 1.2 W			Unit
		Min.	Typ.	Max.	Min.	Typ.	Max.	
Laser Characteristics								
CW output power	P_o	–	–	0.6	–	–	1.2	W
Center wavelength and tolerance	λ_c		808 (± 2.5) 808 (± 7)			808 (± 2.5) 808 (± 7)		nm
Spectral width	$\Delta\lambda$	–	2	–	–	2	–	nm
Slope efficiency	$\eta_d = P_o / (I_{op} - I_{th})$	1.00	1.15	–	1.00	1.15	–	W/A
Conversion efficiency	$\eta = P_o / (I_{op} V_{op})$	–	45	–	–	45	–	%
Emitting dimensions	W x H	–	100 x 1	–	–	100 x 1	–	μm
FWHM beam divergence								
Parallel to junction	$\theta_{//}$	–	7	10	–	7	10	degrees
Perpendicular to junction	θ_{\perp}	–	30	33	–	30	33	degrees
90% power in angle beam divergence								
Parallel to junction	$\theta_{//,90\%}$	5.6	–	–	5.6	–	–	degrees
Threshold current	I_{th}	–	0.32	0.40	–	0.32	0.40	A
Operating current	I_{op}	–	0.85	1.00	–	1.35	1.55	A
Operating voltage	V_{op}	–	1.8	2.0	–	1.9	2.0	V
Series resistance	R_s	–	0.27	–	–	0.27	–	Ω
Thermal resistance	R_{th}	–	12	–	–	12	–	$^{\circ}\text{C}/\text{W}$
Recommended case temperature	T_c	15	–	30	15	–	30	$^{\circ}\text{C}$
Absolute Maximum and Minimum Ratings								
Breakdown voltage	V_b	3	–	–	3	–	–	V
Case operating temperature	T_{op}	-20	–	50	-20	–	50	$^{\circ}\text{C}$
Storage temperature range	T_{stg}	-40	–	80	-40	–	80	$^{\circ}\text{C}$
Lead soldering temperature	T_{is}	–	–	250 (5 sec.)	–	–	250 (5 sec.)	$^{\circ}\text{C}$
Monitor Photodiode								
Sensitivity	–	0.2	–	10	0.2	–	10	$\mu\text{A}/\text{mW}$
Capacitance	–	–	6	–	–	6	–	pF
Breakdown voltage	V_{bd}	–	25	–	–	25	–	V
Operating voltage	V_{op}	–	10	–	–	10	–	V
Reliability (at P_o, 25$^{\circ}\text{C}$)								
Mean time to failure	MTTF	–	200,000	–	–	200,000	–	Hr

Note:

Typical value at 25 $^{\circ}\text{C}$ and 0.6 NA collection optics

6

Electro-optical Specifications

Parameter	Symbol	2455-A1.2 W			2465-A 2.0 W			Unit
		Min.	Typ.	Max.	Min.	Typ.	Max.	
Laser Characteristics								
CW output power	P_o	–	–	1.2	–	–	2.0	W
Center wavelength and tolerance	λ_c		808 (± 2.5) 808 (± 7)			808 (± 2.5) 808 (± 7)		nm
Spectral width	$\Delta\lambda$	–	2	–	–	2	–	nm
Slope efficiency	$\eta_d = P_o/(I_{op}-I_{th})$	1.00	1.15	–	0.95	1.10	–	W/A
Conversion efficiency	$\eta = P_o/(I_{op}V_{op})$	–	45	–	–	45	–	%
Emitting dimensions	W x H	–	100 x 1	–	–	100 x 1	–	μm
FWHM beam divergence								
Parallel to junction	$\theta_{//}$	–	7	11	–	7	11	degrees
Perpendicular to junction	θ_{\perp}	–	30	33	–	30	33	degrees
90% power in angle beam divergence								
Parallel to junction	$\theta_{//,90\%}$	5.6	–	–	5.6	–	–	degrees
Threshold current	I_{th}	–	0.32	0.40	–	0.65	0.75	A
Operating current	I_{op}	–	1.35	1.55	–	2.40	2.80	A
Operating voltage	V_{op}	–	1.9	2.0	–	1.8	2.0	V
Series resistance	R_s	–	0.27	–	–	0.09	0.12	Ω
Thermal resistance	R_{th}	–	12	–	–	6	–	$^{\circ}\text{C}/\text{W}$
Recommended case temperature	T_c	15	–	30	15	–	30	$^{\circ}\text{C}$
Absolute Maximum and Minimum Ratings								
Breakdown voltage	V_b	3	–	–	3	–	–	V
Case operating temperature	T_{op}	-20	–	50	-20	–	50	$^{\circ}\text{C}$
Storage temperature range	T_{stg}	-40	–	80	-40	–	80	$^{\circ}\text{C}$
Lead soldering temperature	T_{is}	–	–	250 (5 sec.)	–	–	250 (5 sec.)	$^{\circ}\text{C}$
Reliability (at P_o, 25$^{\circ}\text{C}$)								
Mean time to failure	MTTF	–	200,000	–	–	200,000	–	Hr

Note:

Typical value at 25 $^{\circ}\text{C}$ and 0.6 NA collection optics

7

Electro-optical Specifications

Parameter	Symbol	2475-A 3.0 W			2495-Y- 5.0 W			Unit
		Min.	Typ.	Max.	Min.	Typ.	Max.	
Laser Characteristics								
CW output power	P_o	–	–	3.0	–	–	5.0	W
Center wavelength and tolerance	λ_c		808 (± 2.5) 808 (± 7)			808 (± 3) 808 (± 7)		nm
Spectral width	$\Delta\lambda$	–	2	–	–	2	–	nm
Slope efficiency	$\eta_d = P_o/(I_{op}-I_{th})$	0.95	1.10	–	0.90	1.05	–	W/A
Conversion efficiency	$\eta = P_o/(I_{op}V_{op})$	–	45	–	–	45	–	%
Emitting dimensions	W x H	–	100 x 1	–	–	100 x 1	–	μm
FWHM beam divergence								
Parallel to junction	$\theta_{//}$	–	7	11	–	8	11	degrees
Perpendicular to junction	θ_{\perp}	–	30	33	–	30	33	degrees
90% power in angle beam divergence								
Parallel to junction	$\theta_{//,90\%}$	5.6	–	–	5.6	–	–	degrees
Threshold current	I_{th}	–	0.65	0.75	–	0.90	1.05	A
Operating current	I_{op}	–	3.40	3.90	–	5.80	6.30	A
Operating voltage	V_{op}	–	1.9	2.1	–	1.9	2.1	V
Series resistance	R_s	–	0.09	0.12	–	0.06	0.09	Ω
Thermal resistance	R_{th}	–	6	–	–	5	–	$^{\circ}\text{C}/\text{W}$
Recommended case temperature	T_c	15	–	30	15	–	30	$^{\circ}\text{C}$
Absolute Maximum and Minimum Ratings								
Breakdown voltage	V_b	3	–	–	3	–	–	V
Case operating temperature	T_{op}	-20	–	50	-20	–	50	$^{\circ}\text{C}$
Storage temperature range	T_{stg}	-40	–	80	-40	–	80	$^{\circ}\text{C}$
Lead soldering temperature	T_{is}	–	–	250 (5 sec.)	–	–	250 (5 sec.)	$^{\circ}\text{C}$
Reliability (at P_o, 25$^{\circ}\text{C}$)								
Mean time to failure	MTTF	–	100,000	–	–	–	–	Hr

Note:

Typical value at 25 $^{\circ}\text{C}$ and 0.6 NA collection optics

8

Electro-optical Specifications

Parameter	Symbol	2496-Y- 8.5 W			Unit
		Min.	Typ.	Max.	
Laser Characteristics					
CW output power	P_o	–	–	8.5	W
Center wavelength and tolerance	λ_c		808 (± 3) 808 (± 7)		nm
Spectral width	$\Delta\lambda$	–	2	–	nm
Slope efficiency	$\eta_d = P_o/(I_{op}-I_{th})$	1.05	1.12	–	W/A
Conversion efficiency	$\eta = P_o/(I_{op}V_{op})$	–	45	–	%
Emitting dimensions	W x H	–	200 x 1	–	μm
FWHM beam divergence					
Parallel to junction	$\theta_{//}$	–	9	12	degrees
Perpendicular to junction	θ_{\perp}	–	30	33	degrees
Threshold current	I_{th}	–	1.9	2.0	A
Operating current	I_{op}	–	10.0	10.5	A
Operating voltage	V_{op}	–	1.9	2.1	V
Series resistance	R_s	–	0.03	–	Ω
Thermal resistance	R_{th}	–	4.0	–	$^{\circ}\text{C}/\text{W}$
Recommended case temperature	T_c	15	–	30	$^{\circ}\text{C}$
Absolute Maximum and Minimum Ratings					
Breakdown voltage	V_b	3	–	–	V
Case operating temperature	T_{op}	-20	–	50	$^{\circ}\text{C}$
Storage temperature range	T_{stg}	-40	–	80	$^{\circ}\text{C}$
Lead soldering temperature	T_{is}	–	–	250 (5 sec.)	$^{\circ}\text{C}$
Reliability (at P_o, 25$^{\circ}\text{C}$)					
Mean time to failure	MTTF	–	40,000	–	Hr

Note:

Typical value at 25 $^{\circ}\text{C}$ and 0.6 NA collection optics

Typical Optical Characteristics

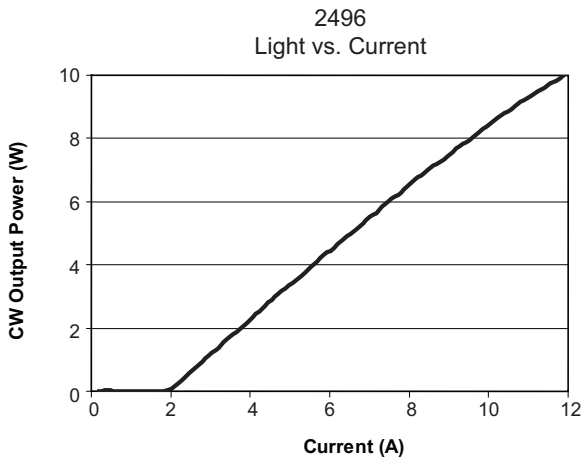
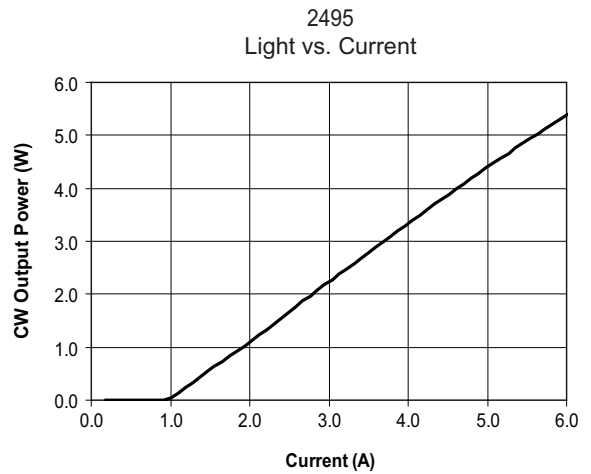
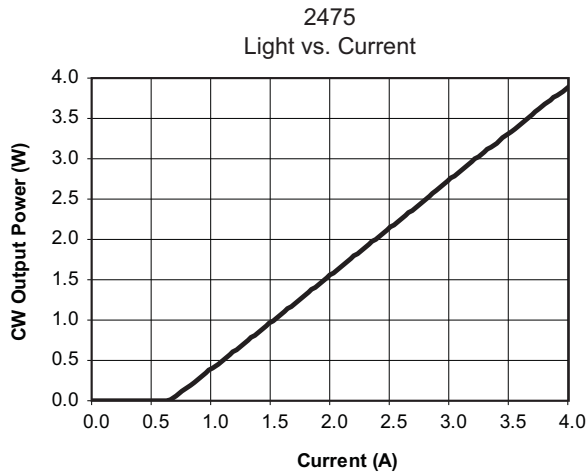
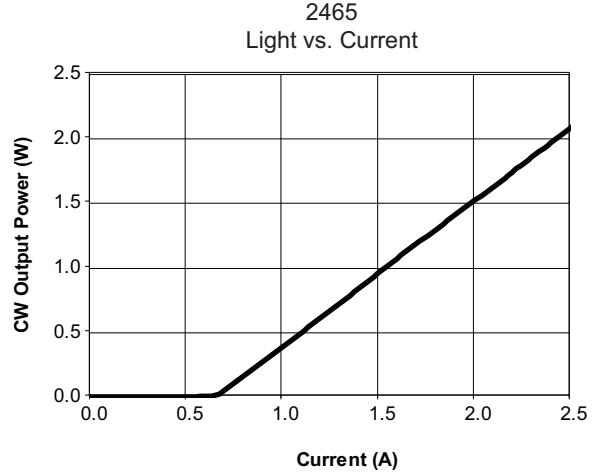
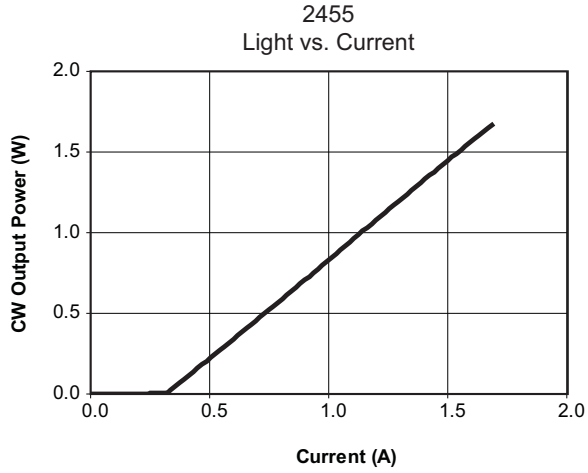

Typical Optical Characteristics

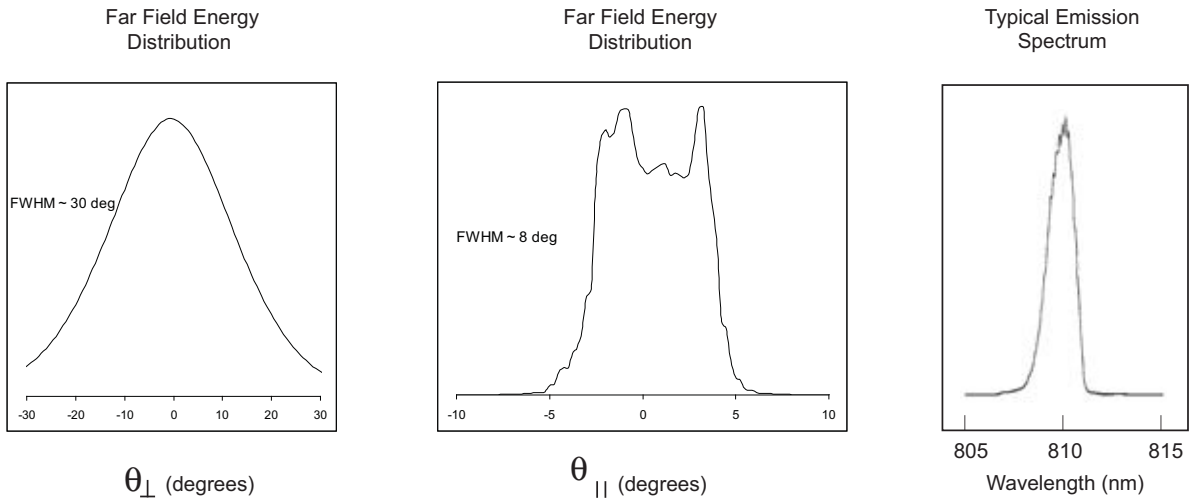

Ordering Information

For more information on this or other products and their availability, please contact your local JDSU account manager or JDSU directly at 1-800-498-JDSU (5378) in North America and +800-5378-JDSU worldwide, or via e-mail at customer.service@jdsu.com.

Sample: 24-00135

Part Number	Power	Emitter Width	Wavelength	Package
Call for samples	0.2 – 1.2 W	35 – 100 μm	808 (± 2.5)	5.6 mm TO-56
Call for samples	0.2 – 1.2 W	35 – 100 μm	808 (± 7)	5.6 mm TO-56
24-00135	0.6 W	100 μm	808 (± 2.5)	9 mm SOT-148
24-00166	0.6 W	100 μm	808 (± 7)	9 mm SOT-148
24-00138	1.2 W	100 μm	808 (± 2.5)	9 mm SOT-148
24-00141	1.2 W	100 μm	808 (± 2.5)	Open Heat Sink "A"
24-00167	1.2 W	100 μm	808 (± 7)	9 mm SOT-148
24-00168	1.2 W	100 μm	808 (± 7)	Open Heat Sink "A"
24-00144	2 W	100 μm	808 (± 2.5)	Open Heat Sink "A"
24-00169	2 W	100 μm	808 (± 2.5)	9 mm SOT-148
24-00170	2 W	100 μm	808 (± 7)	Open Heat Sink "A"
24-00171	2 W	100 μm	808 (± 7)	9 mm SOT-148
24-00147	3 W	100 μm	808 (± 2.5)	Open Heat Sink "A"
24-00172	3 W	100 μm	808 (± 7)	Open Heat Sink "A"
24-00150	5 W	100 μm	808 (± 3)	Open Heat Sink "Y"
24-00173	5 W	100 μm	808 (± 7)	Open Heat Sink "Y"
24-00178	8.5 W	200 μm	808 (± 3)	Open Heat Sink "Y"
24-00179	8.5 W	200 μm	808 (± 7)	Open Heat Sink "Y"
24-00180	8.5 W	200 μm	808 (± 3)	LX submount
24-00181	8.5 W	200 μm	808 (± 7)	LX submount

User Safety
Safety and Operating Considerations

The laser light emitted from this diode laser is invisible and may be harmful to the human eye. Avoid looking directly into the diode laser, into the collimated beam along its optical axis, or directly into the fiber when the device is in operation.

CAUTION: THE USE OF OPTICAL INSTRUMENTS WITH THIS PRODUCT WILL INCREASE EYE HAZARD.

Operating the diode laser outside of its maximum ratings may cause device failure or a safety hazard. Power supplies used with the component must be employed such that the maximum peak optical power cannot be exceeded.

CW diode lasers may be damaged by excessive drive current or switching transients. When power supplies are used, the diode laser should be connected with the main power on and the output voltage at zero. The current should be increased slowly while the diode laser output power and the drive current are monitored.

Device degradation accelerates with increased temperature, and therefore careful attention to minimize the case temperature is advised. For example, life expectancy will decrease by a factor of four if the case is operated at 50°C rather than 30°C.

A proper heatsink for the diode laser on a thermal radiator will greatly enhance laser life. Firmly mount the laser on a radiator with a thermal impedance of less than 0.5°C/W for increased reliability.

ESD PROTECTION – Electrostatic discharge is the primary cause of unexpected diode laser failure. Take extreme precaution to prevent ESD. Use wrist straps, grounded work surfaces and rigorous antistatic techniques when handling diode lasers.

Labeling
21 CFR 1040.10 Compliance

Because of the small size of these devices, each of the labels shown is attached to the individual shipping container. They are illustrated here to comply with 21 CFR 1040.10 as applicable under the Radiation Control for Health and Safety Act of 1968.

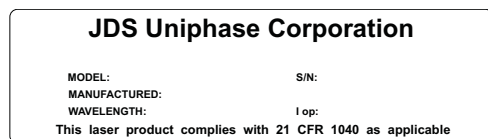
Serial Number Identification Label

Output Power Danger Labels

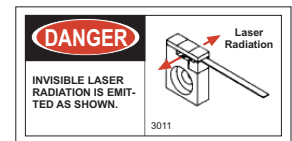
- 2455 Series
- 2465 Series
- 2475 Series
- 2495 Series
- 2496 Series

Package Aperture Label

A Package Diodes



Стандарт Электрон Связь

Мы молодая и активно развивающаяся компания в области поставок электронных компонентов. Мы поставляем электронные компоненты отечественного и импортного производства напрямую от производителей и с крупнейших складов мира.

Благодаря сотрудничеству с мировыми поставщиками мы осуществляем комплексные и плановые поставки широчайшего спектра электронных компонентов.

Собственная эффективная логистика и склад в обеспечивает надежную поставку продукции в точно указанные сроки по всей России.

Мы осуществляем техническую поддержку нашим клиентам и предпродажную проверку качества продукции. На все поставляемые продукты мы предоставляем гарантию .

Осуществляем поставки продукции под контролем ВП МО РФ на предприятия военно-промышленного комплекса России , а также работаем в рамках 275 ФЗ с открытием отдельных счетов в уполномоченном банке. Система менеджмента качества компании соответствует требованиям ГОСТ ISO 9001.

Минимальные сроки поставки, гибкие цены, неограниченный ассортимент и индивидуальный подход к клиентам являются основой для выстраивания долгосрочного и эффективного сотрудничества с предприятиями радиоэлектронной промышленности, предприятиями ВПК и научно-исследовательскими институтами России.

С нами вы становитесь еще успешнее!

Наши контакты:

Телефон: +7 812 627 14 35

Электронная почта: sales@st-electron.ru

Адрес: 198099, Санкт-Петербург,
Промышленная ул, дом № 19, литера Н,
помещение 100-Н Офис 331