

# Hyper TOPLED®

## Hyper-Bright Low Current LED

LS T67K, LO T67K, LY T67K



### Besondere Merkmale

- **Gehäusetyp:** weißes P-LCC-2 Gehäuse, farbloser klarer Verguss
- **Besonderheit des Bauteils:** extrem breite Abstrahlcharakteristik; ideal für Hinterleuchtungen und Einkopplungen in Lichtleiter
- **Wellenlänge:** 630 nm (super-rot), 606 nm (orange), 587 nm (gelb)
- **Abstrahlwinkel:** Lambertscher Strahler (120°)
- **Technologie:** InGaAlP
- **optischer Wirkungsgrad:** 6 lm/W (gelb) 5 lm/W (super-rot), 9 lm/W (orange)
- **Gruppierungsparameter:** Lichtstärke, Wellenlänge
- **Verarbeitungsmethode:** für alle SMT-Bestücktechniken geeignet
- **Lötmethode:** IR Reflow Löten und Wellenlöten (TTW)
- **Vorbehandlung:** nach JEDEC Level 2
- **Gurtung:** 8-mm Gurt mit 2000/Rolle, ø180 mm oder 8000/Rolle, ø330 mm
- **ESD-Festigkeit:** ESD-sicher bis 2 kV nach JESD22-A114-B

### Anwendungen

- Informationsanzeigen im Innenbereich (z. B. im Laufschriftanzeigen)
- optischer Indikator
- Einkopplung in Lichtleiter
- Hinterleuchtung (LCD, Handy, Schalter, Tasten, Displays, Werbebeleuchtung)
- Innenbeleuchtung im Automobilbereich (z.B. Instrumentenbeleuchtung)
- Markierungsbeleuchtung
- Signal- und Symbolleuchten

### Features

- **package:** white P-LCC-2 package, colorless clear resin
- **feature of the device:** extremely wide viewing angle; ideal for backlighting and coupling in light guides
- **wavelength:** 630 nm (super-red), 606 nm (orange), 587 nm (yellow)
- **viewing angle:** Lambertian Emitter (120°)
- **technology:** InGaAlP
- **optical efficiency:** 6 lm/W (yellow) 5 lm/W (super-red), 9 lm/W (orange)
- **grouping parameter:** luminous intensity, wavelength
- **assembly methods:** suitable for all SMT assembly methods
- **soldering methods:** IR reflow soldering and TTW soldering
- **preconditioning:** acc. to JEDEC Level 2
- **taping:** 8 mm tape with 2000/reel, ø180 mm or 8000/reel, ø330 mm
- **ESD-withstand voltage:** up to 2 kV acc. to JESD22-A114-B

### Applications

- indoor displays (e.g. light writing displays)
- optical indicators
- coupling into light guides
- backlighting (LCD, cellular phones, switches, keys, displays, illuminated advertising)
- interior automotive lighting (e.g. dashboard backlighting)
- marker lights
- signal and symbol luminaire

Typ	Emissions- farbe	Lichtstärke	Lichtstrom	Bestellnummer
Type	Color of Emission	Luminous Intensity $I_F = 2 \text{ mA}$ $I_V \text{ (mcd)}$	Luminous Flux $I_F = 2 \text{ mA}$ $\Phi_V \text{ (mlm)}$	Ordering Code
LS T67K-H1J1-1 LS T67K-J1K2-1	super-red	2.80 ... 5.60 4.50 ... 11.20	13 (typ.) 25 (typ.)	Q62703Q6434 Q62703Q6435
LO T67K-J2K2-24 LO T67K-K2M1-24	orange	5.60 ... 11.20 9.00 ... 22.40	25 (typ.) 45 (typ.)	Q62703Q6430 Q62703Q6431
LY T67K-J1K1-26 LY T67K-K1L2-26	yellow	4.50 ... 9.00 7.10 ... 18.00	20 (typ.) 35 (typ.)	Q62703Q6438 Q62703Q6439

Anm.: -1 gesamter Farbbereich (siehe **Seite 4**)  
 -24 gesamter Farbbereich, Lieferung in Einzelgruppen (siehe **Seite 5**)  
 -26 gesamter Farbbereich, Lieferung in Einzelgruppen (siehe **Seite 5**)

Note: -1 Total color tolerance range (please see **page 4**)  
 -24 Total color tolerance range, delivery in single groups (please see **page 5**)  
 -26 Total color tolerance range, delivery in single groups (please see **page 5**)

**Vergleichstabelle für 10 mA**  
**Correlation Table for 10 mA**

Typ	Emissions- farbe	Lichtstärke		Lichtstärke	Lichtstrom
Type	Color of Emission	Luminous Intensity $I_F = 2 \text{ mA}^1$ $I_V \text{ (mcd)}$		Luminous Intensity $I_F = 10 \text{ mA}^1$ $I_V \text{ (mcd)}$	Luminous Flux $I_F = 10 \text{ mA}$ $\Phi_V \text{ (mlm)}$
LS T67K-H1J1-1 LS T67K-J1K2-1	super-red	2.80 ... 5.60 4.50 ... 11.20	⇒	20 (typ.) 40 (typ.)	65 (typ.) 120 (typ.)
LO T67K-J2K2-24 LO T67K-K2M1-24	orange	5.60 ... 11.20 9.00 ... 22.40	⇒	35 (typ.) 65 (typ.)	100 (typ.) 190 (typ.)
LY T67K-J1K1-26 LY T67K-K1L2-26	yellow	4.50 ... 9.00 7.10 ... 18.00	⇒	30 (typ.) 60 (typ.)	90 (typ.) 180 (typ.)

Siehe auch Grafik auch **Seite 7** / Please see also graph on **page 7**

<sup>1)</sup> Wegen der besonderen Prozessbedingungen bei der Herstellung von LED können typische oder abgeleitete technische Parameter nur aufgrund statistischer Werte wiedergeben werden. Diese stimmen nicht notwendigerweise mit den Werten jedes einzelnen Produktes überein, dessen Werte sich von typischen und abgeleiteten Werten unterscheiden können .

Due to the special conditions of the manufacturing processes of LED, the typical data or calculated correlations of technical parameters can only reflect statistical figures. These do not necessarily correspond to the actual parameters of each single product, which could differ from the typical data or the typical characteristic line.

**Grenzwerte**  
**Maximum Ratings**

Bezeichnung Parameter	Symbol Symbol	Werte Values		Einheit Unit
		LS, LO	LY	
Betriebstemperatur Operating temperature range	$T_{op}$	- 40 ... + 100		°C
Lagertemperatur Storage temperature range	$T_{stg}$	- 40 ... + 100		°C
Sperrschichttemperatur Junction temperature	$T_j$	+ 125		°C
Durchlassstrom Forward current ( $T_A=25^\circ\text{C}$ )	$I_F$	20		mA
Stoßstrom Surge current $t \leq 10 \mu\text{s}$ , $D = 0.005$ , $T_A=25^\circ\text{C}$	$I_{FM}$	100		mA
Sperrspannung <sup>1)</sup> Reverse voltage ( $T_A=25^\circ\text{C}$ )	$V_R$	12		V
Leistungsaufnahme Power consumption ( $T_A=25^\circ\text{C}$ )	$P_{tot}$	50		mW
Wärmewiderstand Thermal resistance Sperrschicht/Umgebung <sup>2)</sup> Junction/ambient <sup>2)</sup>	$R_{th JA}$	420		K/W
Sperrschicht/Löt看pad Junction/solder point	$R_{th JS}$	260		K/W

<sup>1)</sup> für kurzzeitigen Betrieb geeignet / suitable for short term application

<sup>2)</sup> Montage auf PC-Board FR 4 (Padgröße  $\geq 16 \text{ mm}^2$ )  
mounted on PC board FR 4 (pad size  $\geq 16 \text{ mm}^2$ )

**Kennwerte** ( $T_A = 25\text{ °C}$ )

**Characteristics**

Bezeichnung Parameter	Symbol Symbol	Werte Values			Einheit Unit
		LS	LO	LY	
Wellenlänge des emittierten Lichtes (typ.) Wavelength at peak emission $I_F = 2\text{ mA}$	$\lambda_{\text{peak}}$	643	610	591	nm
Dominantwellenlänge <sup>1)</sup> Dominant wavelength $I_F = 2\text{ mA}$	$\lambda_{\text{dom}}$	630 $\pm 6$	606 -6/+3	587 -7/+8	nm
Spektrale Bandbreite bei 50 % $I_{\text{rel max}}$ (typ.) Spectral bandwidth at 50 % $I_{\text{rel max}}$ $I_F = 2\text{ mA}$	$\Delta\lambda$	16	16	15	nm
Abstrahlwinkel bei 50 % $I_V$ (Vollwinkel) (typ.) Viewing angle at 50 % $I_V$	$2\phi$	120	120	120	Grad deg.
Durchlassspannung <sup>2)</sup> (typ.) Forward voltage (max.) $I_F = 2\text{ mA}$	$V_F$ $V_F$	1.8 2.2	1.8 2.2	1.8 2.2	V V
Sperrstrom (typ.) Reverse current (max.) $V_R = 12\text{ V}$	$I_R$ $I_R$	0.01 10	0.01 10	0.01 10	$\mu\text{A}$ $\mu\text{A}$
Temperaturkoeffizient von $\lambda_{\text{peak}}$ (typ.) Temperature coefficient of $\lambda_{\text{peak}}$ $I_F = 2\text{ mA}; -10\text{ °C} \leq T \leq 100\text{ °C}$	$TC_{\lambda_{\text{peak}}}$	0.14	0.14	0.12	nm/K
Temperaturkoeffizient von $\lambda_{\text{dom}}$ (typ.) Temperature coefficient of $\lambda_{\text{dom}}$ $I_F = 2\text{ mA}; -10\text{ °C} \leq T \leq 100\text{ °C}$	$TC_{\lambda_{\text{dom}}}$	0.05	0.09	0.09	nm/K
Temperaturkoeffizient von $V_F$ (typ.) Temperature coefficient of $V_F$ $I_F = 2\text{ mA}; -10\text{ °C} \leq T \leq 100\text{ °C}$	$TC_V$	- 1.8	- 1.5	- 2.1	mV/K
Optischer Wirkungsgrad (typ.) Optical efficiency $I_F = 2\text{ mA}$	$\eta_{\text{opt}}$	5	9	6	lm/W

<sup>1)</sup> Wellenlängengruppen werden mit einer Stromeinprägedauer von 25 ms und einer Genauigkeit von  $\pm 1\text{ nm}$  ermittelt.  
Wavelength groups are tested at a current pulse duration of 25 ms and a tolerance of  $\pm 1\text{ nm}$ .

<sup>2)</sup> Spannungswerte werden mit einer Stromeinprägedauer von 1 ms und einer Genauigkeit von  $\pm 0,1\text{ V}$  ermittelt.  
Voltages are tested at a current pulse duration of 1 ms and a tolerance of  $\pm 0.1\text{ V}$ .

1) Wellenlängengruppen für Dominantwellenlänge  
Wavelength groups for dominant wavelength

Gruppe Group	yellow		orange		Einheit Unit
	min.	max.	min.	max.	
2	580	583	600	603	nm
3	583	586	603	606	nm
4	586	589	606	609	nm
5	589	592			nm
6	592	595			nm

Helligkeits-Gruppierungsschema  
Luminous Intensity Groups

Lichtgruppe Luminous Intensity Group	Lichtstärke Luminous Intensity $I_V$ (mcd)	Lichtstrom Luminous Flux $\Phi_V$ (mlm)
H1	2.80 ... 3.55	10 (typ.)
H2	3.55 ... 4.50	12 (typ.)
J1	4.50 ... 5.60	15 (typ.)
J2	5.60 ... 7.10	19 (typ.)
K1	7.10 ... 9.00	24 (typ.)
K2	9.00 ... 11.20	30 (typ.)
L1	11.20 ... 14.00	40 (typ.)
L2	14.00 ... 18.00	50 (typ.)
M1	18.00 ... 22.40	60 (typ.)

Helligkeitswerte werden mit einer Stromeinprägedauer von 25 ms und einer Genauigkeit von  $\pm 11\%$  ermittelt.  
Luminous intensity is tested at a current pulse duration of 25 ms and a tolerance of  $\pm 11\%$ .

Anm.: Die Standardlieferform von Serientypen beinhaltet eine untere bzw. eine obere Familiengruppe. Diese besteht aus 3 bzw. 4 Helligkeitshalbgruppen. Einzelne Helligkeitshalbgruppen sind nicht bestellbar.  
In einer Verpackungseinheit / Gurt ist immer nur eine Helligkeitshalbgruppe enthalten.

Note: The standard shipping format for serial types includes a lower or upper family group of 3 or 4 individual luminous intensity half groups. Individual luminous intensity half groups cannot be ordered.  
No packing unit / tape ever contains more than one luminous intensity half group.

Gruppenbezeichnung auf Etikett  
Group Name on Label

Beispiel: K2-3  
Example: K2-3

Lichtgruppe Luminous Intensity Group	Halbgruppe Half Group	Wellenlänge Wavelength
K	2	3

Relative spektrale Emission  $I_{rel} = f(\lambda)$ ,  $T_A = 25\text{ °C}$ ,  $I_F = 2\text{ mA}$

**Relative Spectral Emission**

$V(\lambda)$  = spektrale Augenempfindlichkeit

Standard eye response curve

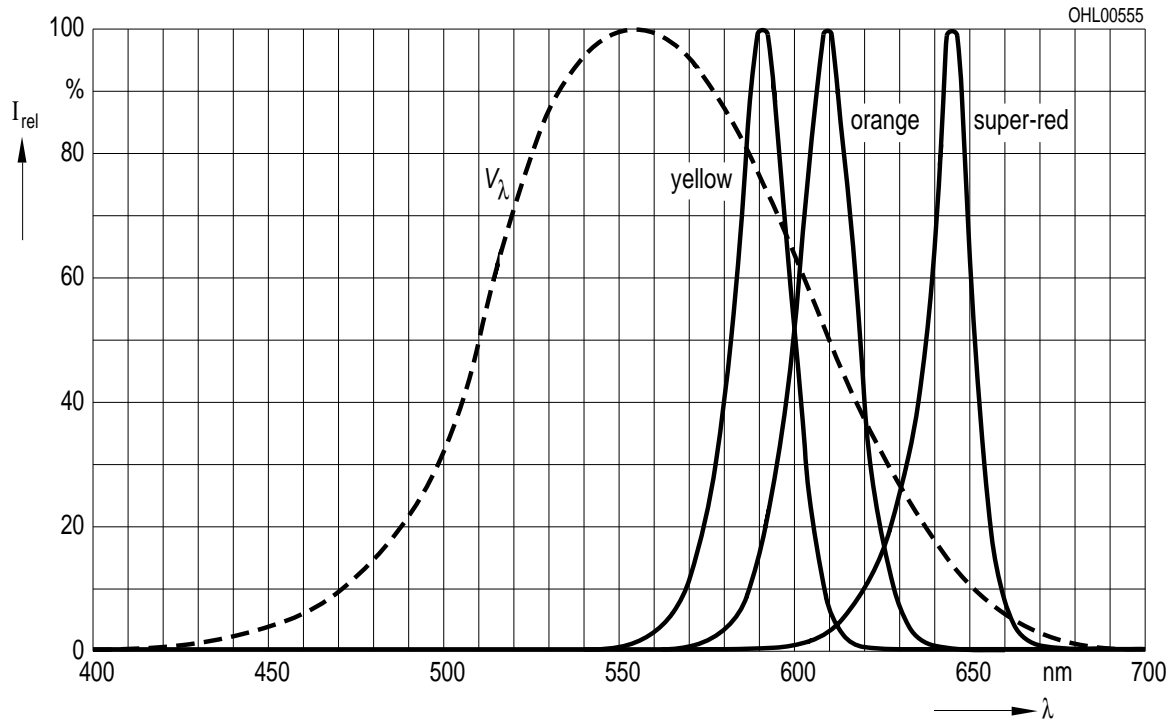

Abstrahlcharakteristik  $I_{rel} = f(\varphi)$

**Radiation Characteristic**

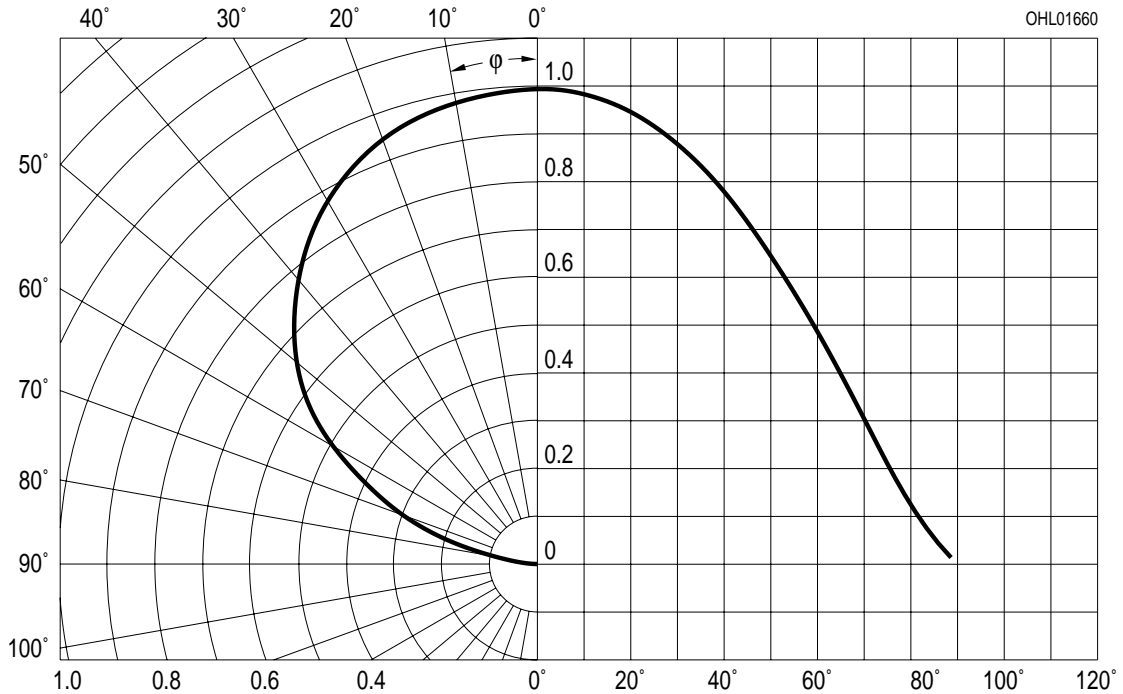

**Durchlassstrom  $I_F = f(V_F)$**   
**Forward Current**

$T_A = 25\text{ °C}$

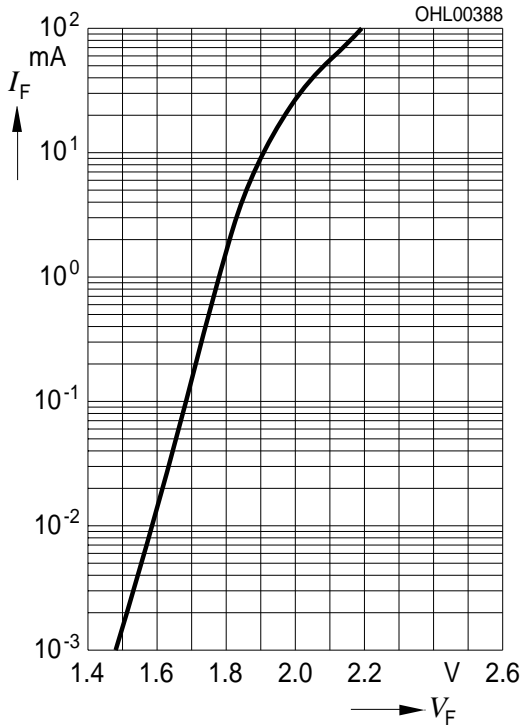

**Relative Lichtstärke  $I_V/I_{V(2\text{ mA})} = f(I_F)$**   
**Relative Luminous Intensity**

$T_A = 25\text{ °C}$

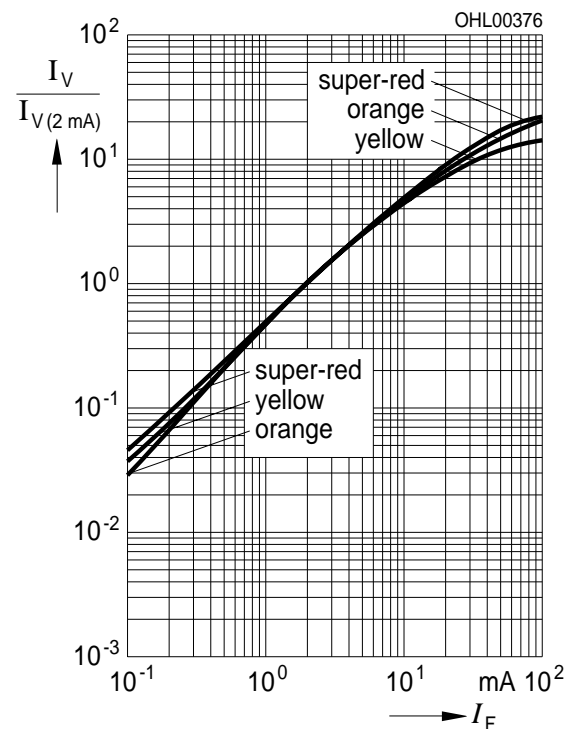

**Maximal zulässiger Durchlassstrom  $I_F = f(T)$**   
**Max. Permissible Forward Current**

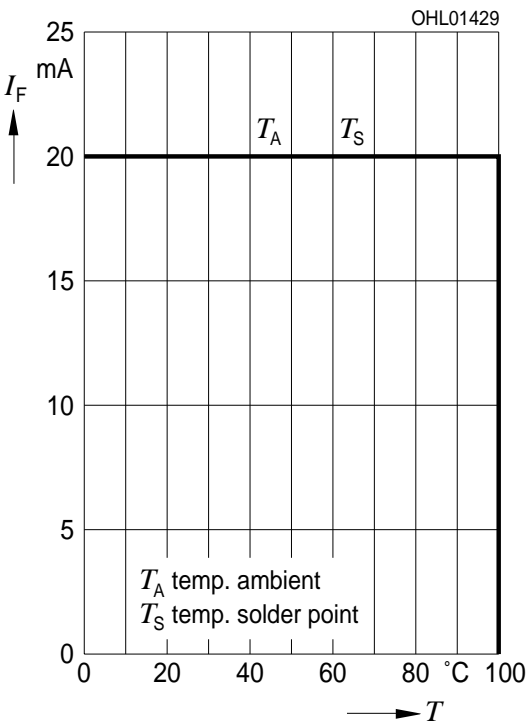

**Relative Lichtstärke  $I_V/I_{V(25\text{ °C})} = f(T_A)$**   
**Relative Luminous Intensity  $I_F = 2\text{ mA}$**

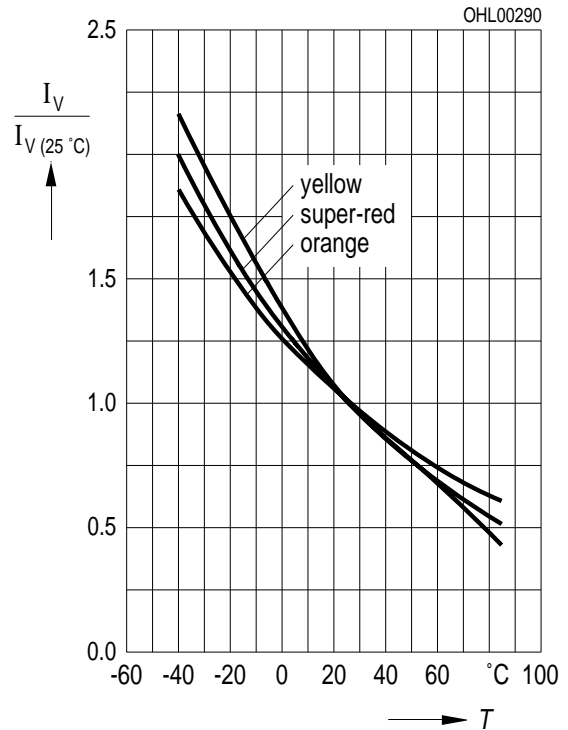

**Zulässige Impulsbelastbarkeit  $I_F = f(t_p)$**   
**Permissible Pulse Handling Capability**  
 Duty cycle  $D =$  parameter,  $T_A = 25\text{ °C}$

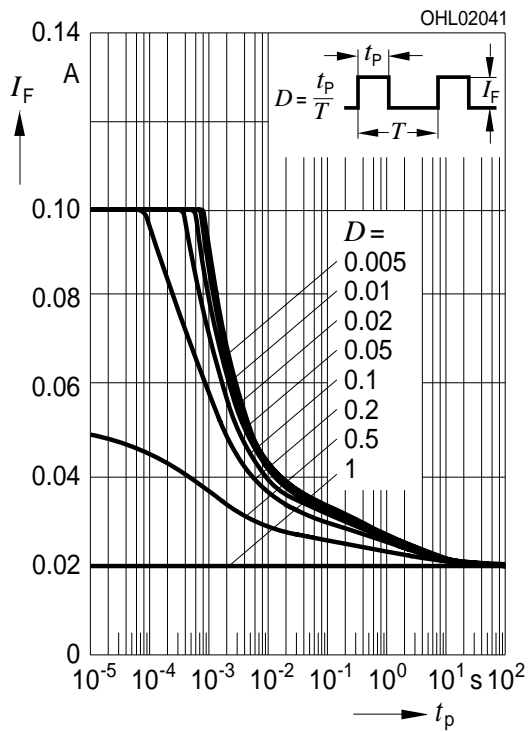

**Zulässige Impulsbelastbarkeit  $I_F = f(t_p)$**   
**Permissible Pulse Handling Capability**  
 Duty cycle  $D =$  parameter,  $T_A = 85\text{ °C}$

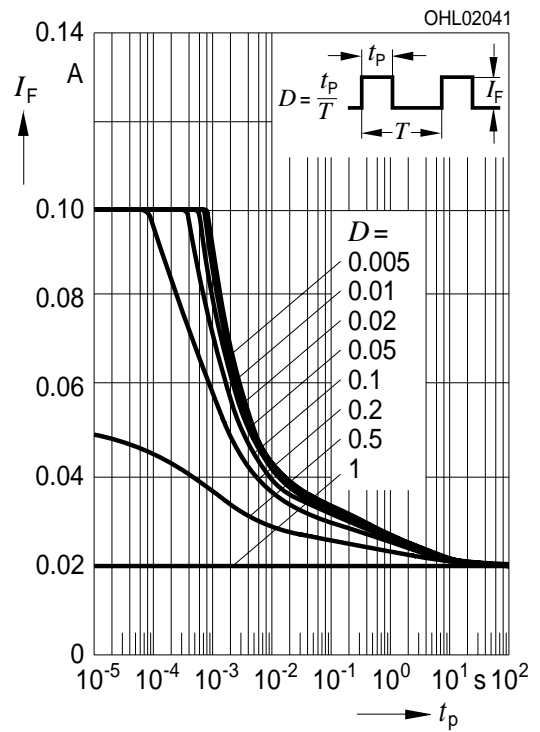



**Maßzeichnung**  
**Package Outlines**

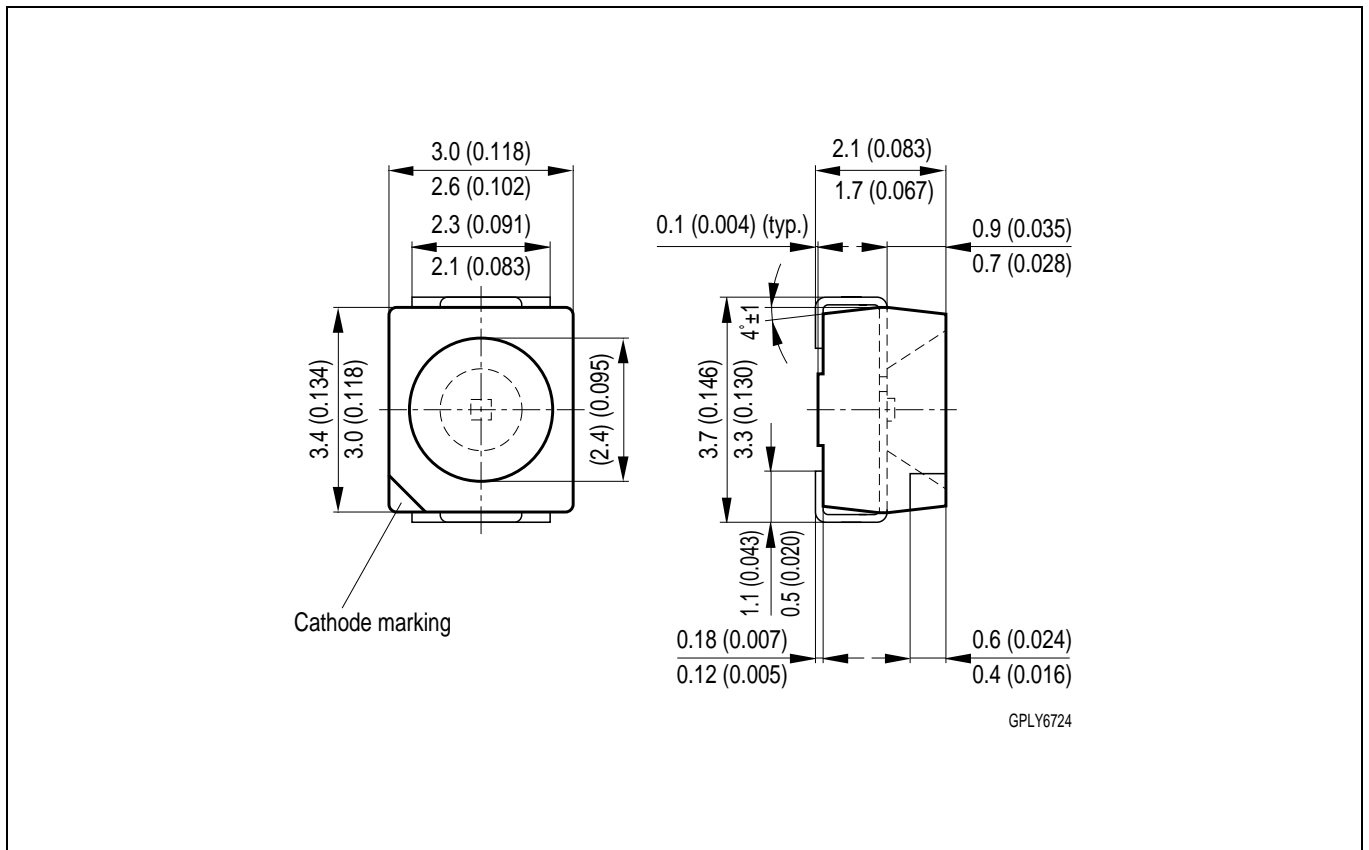

Maße werden wie folgt angegeben: mm (inch) / Dimensions are specified as follows: mm (inch).

**Kathodenkennung:** abgeschrägte Ecke  
**Cathode mark:** bevelled edge  
**Gewicht / Approx. weight:** 35 mg

**Lötbedingungen** Vorbehandlung nach JEDEC Level 2  
**Soldering Conditions** Preconditioning acc. to JEDEC Level 2

**IR-Reflow Lötprofil** (nach IPC 9501)  
**IR Reflow Soldering Profile** (acc. to IPC 9501)

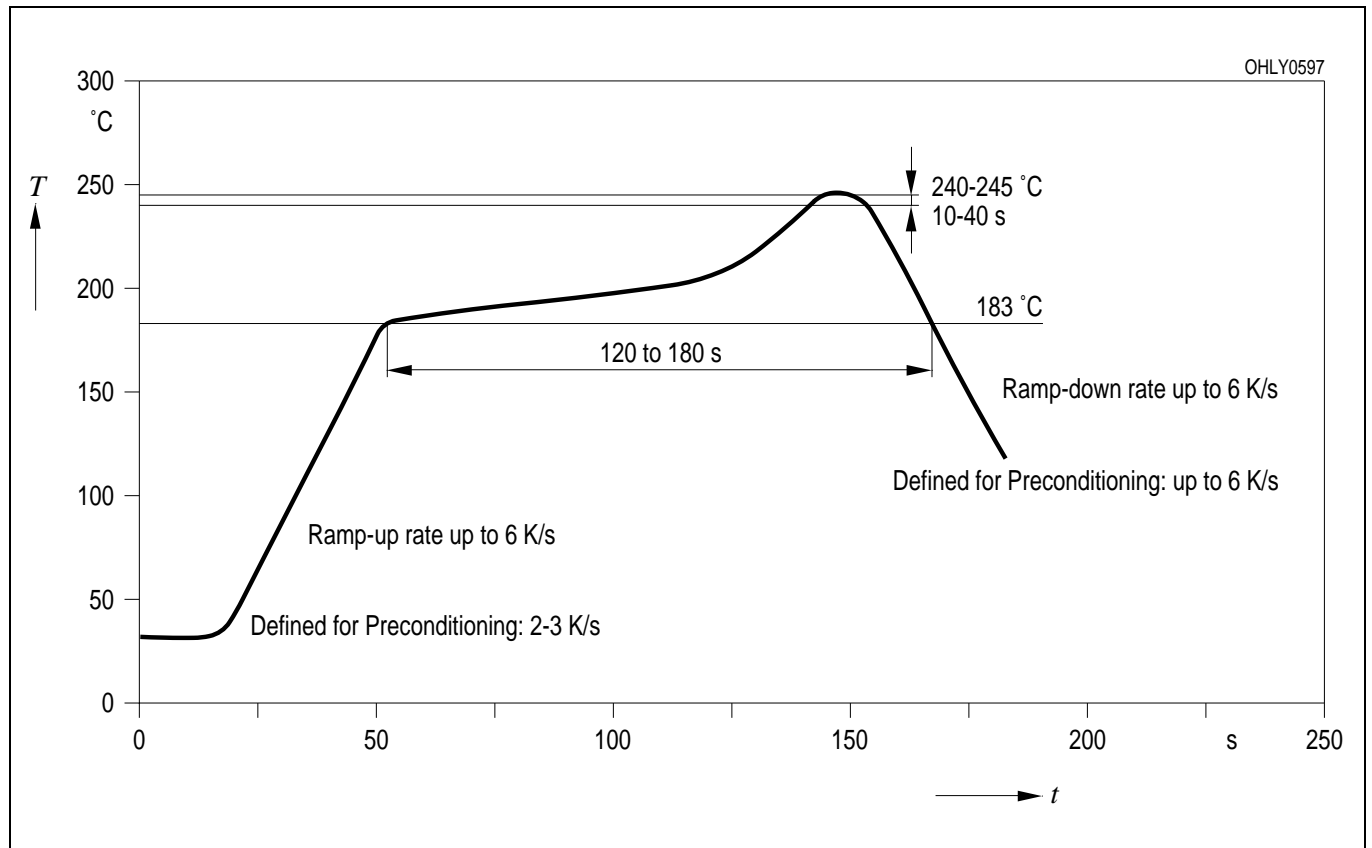

**Wellenlöten (TTW)** (nach CECC 00802)  
**TTW Soldering** (acc. to CECC 00802)

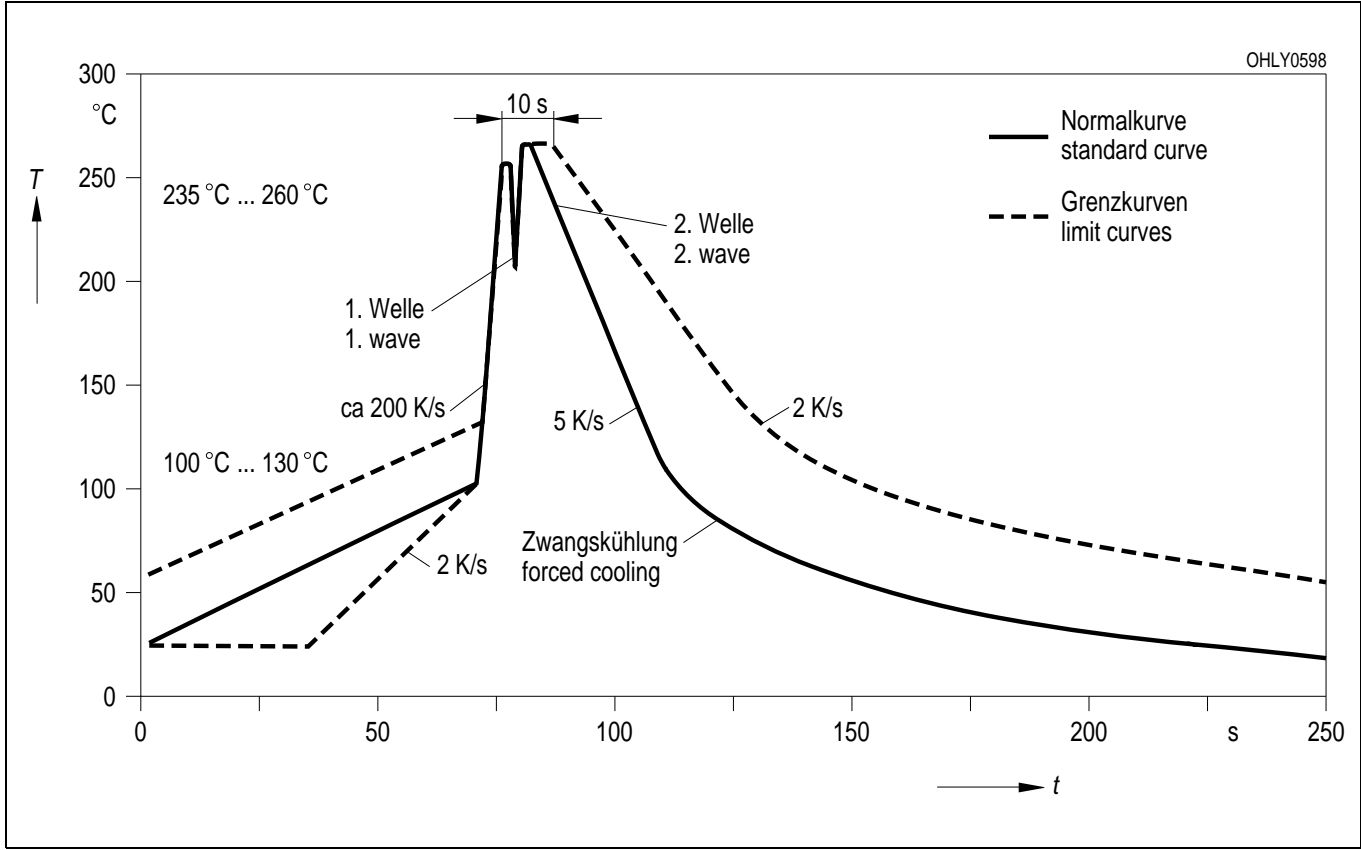

**Empfohlenes Lötpad Design** IR-Reflow Lötén  
**Recommended Solder Pad** IR Reflow Soldering

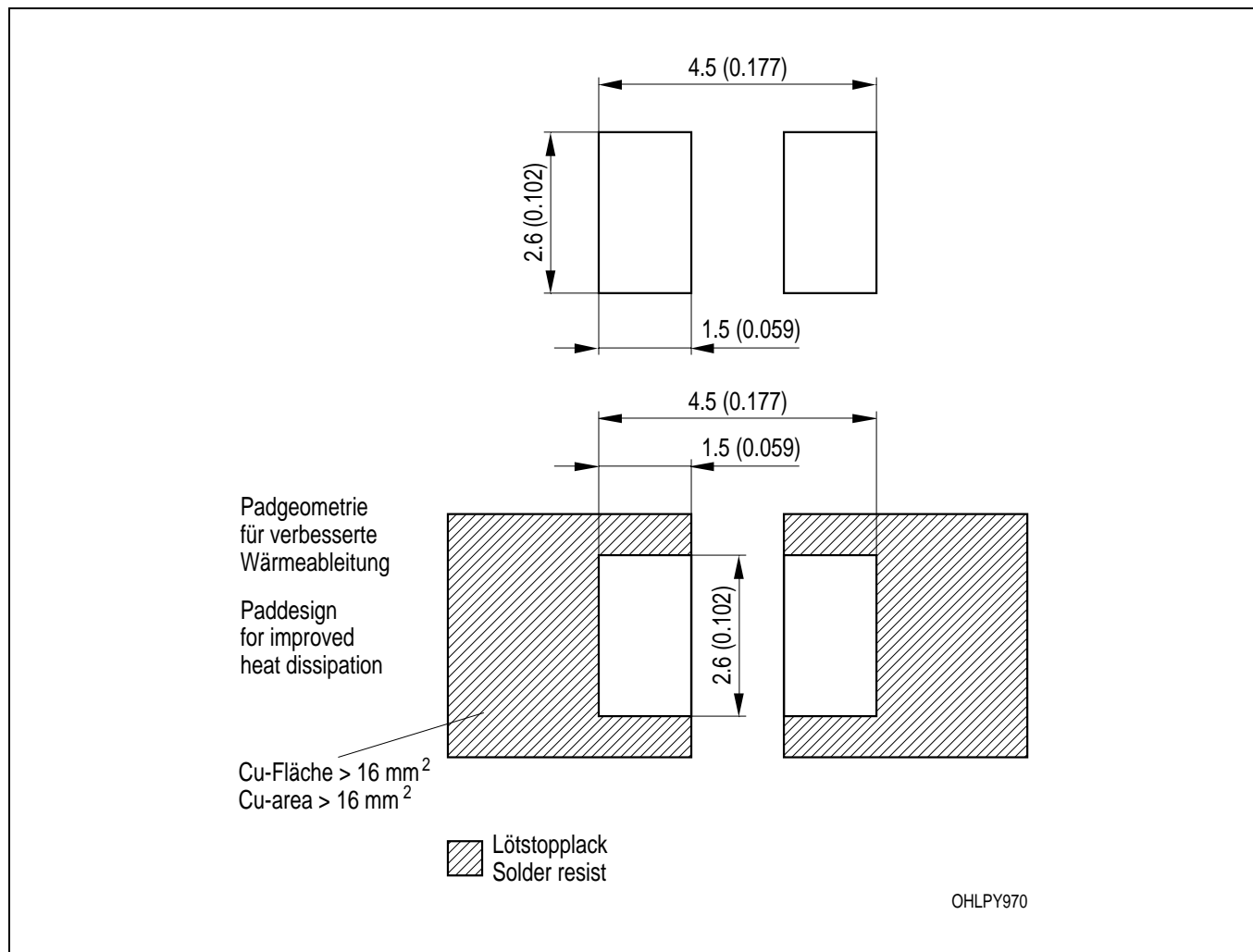

Maße werden wie folgt angegeben: mm (inch) / Dimensions are specified as follows: mm (inch)  
 Gehäuse hält TTW-Löthitze aus / Package able to withstand TTW-soldering heat

**Empfohlenes Lötpaddesign verwendbar für TOPLED® und Power TOPLED®**

IR Reflow Löten

**Recommended Solder Pad useable for TOPLED® and Power TOPLED®**

IR Reflow Soldering

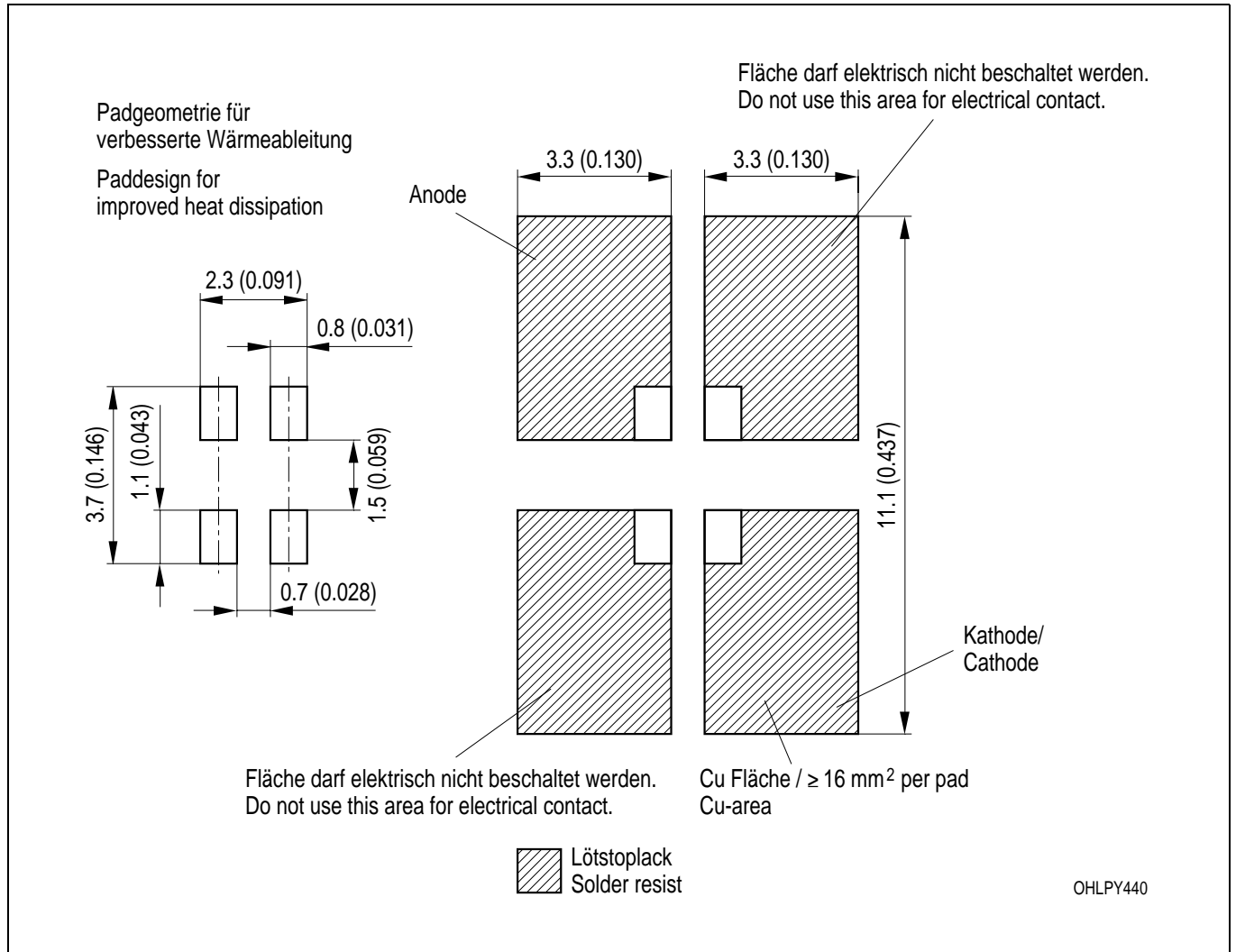

Maße werden wie folgt angegeben: mm (inch) / Dimensions are specified as follows: mm (inch).

**Gurtung / Polarität und Lage**

Verpackungseinheit 2000/Rolle, ø180 mm  
oder 8000/Rolle, ø330 mm

**Method of Taping / Polarity and Orientation**

Packing unit 2000/reel, ø180 mm  
or 8000/reel, ø330 mm

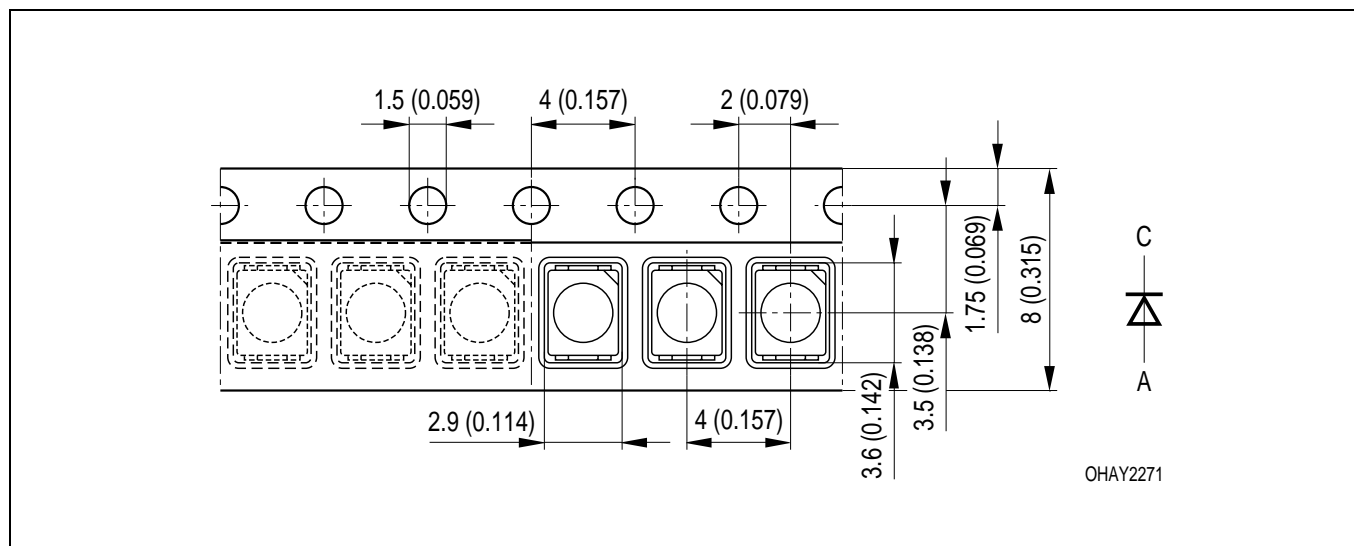

Maße werden wie folgt angegeben: mm (inch) / Dimensions are specified as follows: mm (inch)

*Anm.: Bezüglich Trockenverpackung finden Sie weitere Hinweise im Internet und in unserem Short Form Catalog im Kapitel "Gurtung und Verpackung" unter dem Punkt "Trockenverpackung". Hier sind Normenbezüge, unter anderem ein Auszug der JEDEC-Norm, enthalten.*

*Note: Regarding dry pack you will find further information in the internet and in the Short Form Catalog in chapter "Tape and Reel" under the topic "Dry Pack". Here you will also find the normative references like JEDEC.*

Revision History: 2003-09-18		Date of change
Previous Version: 2003-09-09		
Page	Subjects (major changes since last revision)	
3	Forward current	2003-07-24
3	Power consumption	2003-07-24
7	Max. Permissible Forward Current	2003-07-24
3	Thermal resistance	2003-07-24
14	note: dry pack	2003-09-09
1	ESD norm	2003-09-09
3	ambient temperature	2003-09-09
8	Permissible pulse handling capability	2003-09-18

**Published by OSRAM Opto Semiconductors GmbH**  
**Wernerwerkstrasse 2, D-93049 Regensburg**  
**© All Rights Reserved.**

**Attention please!**

The information describes the type of component and shall not be considered as assured characteristics. All typical data and graphs are basing on representative samples, but don't represent the production range. If requested, e.g. because of technical improvements, these typ. data will be changed without any further notice. Terms of delivery and rights to change design reserved. Due to technical requirements components may contain dangerous substances. For information on the types in question please contact our Sales Organization. If printed or downloaded, please find the latest version in the Internet.

**Packing**

Please use the recycling operators known to you. We can also help you – get in touch with your nearest sales office. By agreement we will take packing material back, if it is sorted. You must bear the costs of transport. For packing material that is returned to us unsorted or which we are not obliged to accept, we shall have to invoice you for any costs incurred.

**Components used in life-support devices or systems must be expressly authorized for such purpose!** Critical components <sup>1</sup> may only be used in life-support devices or systems <sup>2</sup> with the express written approval of OSRAM OS.

<sup>1</sup> A critical component is a component used in a life-support device or system whose failure can reasonably be expected to cause the failure of that life-support device or system, or to affect its safety or the effectiveness of that device or system.

<sup>2</sup> Life support devices or systems are intended (a) to be implanted in the human body, or (b) to support and/or maintain and sustain human life. If they fail, it is reasonable to assume that the health of the user may be endangered.



## Стандарт Электрон Связь

Мы молодая и активно развивающаяся компания в области поставок электронных компонентов. Мы поставляем электронные компоненты отечественного и импортного производства напрямую от производителей и с крупнейших складов мира.

Благодаря сотрудничеству с мировыми поставщиками мы осуществляем комплексные и плановые поставки широчайшего спектра электронных компонентов.

Собственная эффективная логистика и склад в обеспечивает надежную поставку продукции в точно указанные сроки по всей России.

Мы осуществляем техническую поддержку нашим клиентам и предпродажную проверку качества продукции. На все поставляемые продукты мы предоставляем гарантию .

Осуществляем поставки продукции под контролем ВП МО РФ на предприятия военно-промышленного комплекса России , а также работаем в рамках 275 ФЗ с открытием отдельных счетов в уполномоченном банке. Система менеджмента качества компании соответствует требованиям ГОСТ ISO 9001.

Минимальные сроки поставки, гибкие цены, неограниченный ассортимент и индивидуальный подход к клиентам являются основой для выстраивания долгосрочного и эффективного сотрудничества с предприятиями радиоэлектронной промышленности, предприятиями ВПК и научно-исследовательскими институтами России.

С нами вы становитесь еще успешнее!

### Наши контакты:

**Телефон:** +7 812 627 14 35

**Электронная почта:** [sales@st-electron.ru](mailto:sales@st-electron.ru)

**Адрес:** 198099, Санкт-Петербург,  
Промышленная ул, дом № 19, литера Н,  
помещение 100-Н Офис 331