

**TN3725A**

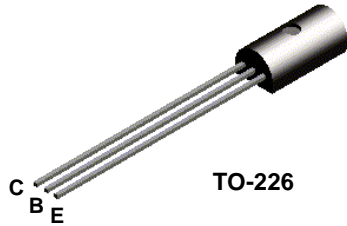

**MMPQ3725**

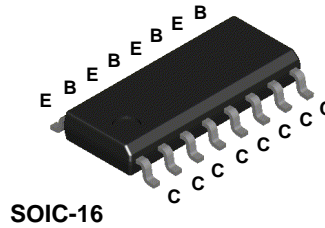

**NPN Switching Transistor**

This device is designed for high speed core driver applications up to collector currents of 1.0 A. Sourced from Process 25.

**Absolute Maximum Ratings**

TA = 25°C unless otherwise noted

Symbol	Parameter	Value	Units
V <sub>CEO</sub>	Collector-Emitter Voltage	40	V
V <sub>CBO</sub>	Collector-Base Voltage	60	V
V <sub>EBO</sub>	Emitter-Base Voltage	6.0	V
I <sub>C</sub>	Collector Current - Continuous	1.2	A
T <sub>J</sub> , T <sub>stg</sub>	Operating and Storage Junction Temperature Range	-55 to +150	°C

\*These ratings are limiting values above which the serviceability of any semiconductor device may be impaired.

**NOTES:**

- 1) These ratings are based on a maximum junction temperature of 150 degrees C.
- 2) These are steady state limits. The factory should be consulted on applications involving pulsed or low duty cycle operations.

**Thermal Characteristics**

TA = 25°C unless otherwise noted

Symbol	Characteristic	Max		Units
		TN3725A	MMPQ3725	
P <sub>D</sub>	Total Device Dissipation Derate above 25°C	1.0	1.0	W
		8.0	8.0	mW/°C
R <sub>θJC</sub>	Thermal Resistance, Junction to Case	50		°C/W
R <sub>θJA</sub>	Thermal Resistance, Junction to Ambient Effective 4 Die Each Die	125		°C/W
			125	°C/W
			240	°C/W

# NPN Switching Transistor

(continued)

## Electrical Characteristics

TA= 25°C unless otherwise noted

Symbol	Parameter	Test Conditions	Min	Max	Units
<b>OFF CHARACTERISTICS</b>					
$V_{(BR)CEO}$	Collector-Emitter Breakdown Voltage*	$I_C = 10 \text{ mA}, I_B = 0$	40		V
$V_{(BR)CES}$	Collector-Emitter Breakdown Voltage	$I_C = 10 \text{ } \mu\text{A}, V_{BE} = 0$	60		V
$V_{(BR)CBO}$	Collector-Base Breakdown Voltage	$I_C = 10 \text{ } \mu\text{A}, I_{CE} = 0$	60		V
$V_{(BR)EBO}$	Emitter-Base Breakdown Voltage	$I_E = 10 \text{ } \mu\text{A}, I_C = 0$	6.0		V
$I_{CBO}$	Collector Cutoff Current	$V_{CB} = 60 \text{ V}, I_E = 0$ $V_{CB} = 60 \text{ V}, I_E = 0, T_A = 100^\circ\text{C}$		1.7 120	$\mu\text{A}$ $\mu\text{A}$
$I_{CES}$	Collector Cutoff Current	$V_{CE} = 80 \text{ V}, V_{EB} = 0$		10	$\mu\text{A}$

## ON CHARACTERISTICS\*

$h_{FE}$	DC Current Gain	$I_C = 10 \text{ mA}, V_{CE} = 1.0 \text{ V}$ $I_C = 100 \text{ mA}, V_{CE} = 1.0 \text{ V}$ $I_C = 100 \text{ mA}, V_{CE} = 1.0 \text{ V}, T_A = -55^\circ\text{C}$ $I_C = 300 \text{ mA}, V_{CE} = 1.0 \text{ V}$ $I_C = 500 \text{ mA}, V_{CE} = 1.0 \text{ V}$ $I_C = 500 \text{ mA}, V_{CE} = 1.0 \text{ V}, T_A = -55^\circ\text{C}$ $I_C = 800 \text{ mA}, V_{CE} = 2.0 \text{ V}$ $I_C = 1.0 \text{ A}, V_{CE} = 5.0 \text{ V}$	30 60 30 40 35 20 20 25	150	
$V_{CE(sat)}$	Collector-Emitter Saturation Voltage	$I_C = 10 \text{ mA}, I_B = 1.0 \text{ mA}$ $I_C = 100 \text{ mA}, I_B = 10 \text{ mA}$ $I_C = 300 \text{ mA}, I_B = 30 \text{ mA}$ $I_C = 500 \text{ mA}, I_B = 50 \text{ mA}$ $I_C = 800 \text{ mA}, I_B = 80 \text{ mA}$ $I_C = 1.0 \text{ A}, I_B = 100 \text{ mA}$		0.25 0.26 0.4 0.52 0.8 0.95	V V V V V V
$V_{BE(sat)}$	Base-Emitter Saturation Voltage	$I_C = 10 \text{ mA}, I_B = 1.0 \text{ mA}$ $I_C = 100 \text{ mA}, I_B = 10 \text{ mA}$ $I_C = 300 \text{ mA}, I_B = 30 \text{ mA}$ $I_C = 500 \text{ mA}, I_B = 50 \text{ mA}$ $I_C = 800 \text{ mA}, I_B = 80 \text{ mA}$ $I_C = 1.0 \text{ A}, I_B = 100 \text{ mA}$		0.76 0.86 1.1 1.2 1.5 1.7	V V V V V V

## SMALL SIGNAL CHARACTERISTICS

$f_T$	Current Gain - Bandwidth Product	$I_C = 50 \text{ mA}, V_{CE} = 10 \text{ V},$ $f = 100 \text{ MHz}$	300		MHz
$C_{obo}$	Output Capacitance	$V_{CB} = 10 \text{ V}, I_E = 0,$ $f = 1.0 \text{ MHz}$		10	pF
$C_{ibo}$	Input Capacitance	$V_{EB} = 0.5 \text{ V}, I_C = 0,$ $f = 1.0 \text{ MHz}$		55	pF

## SWITCHING CHARACTERISTICS (except MMPQ3725)

$t_{on}$	Turn-on Time	$V_{CC} = 30 \text{ V}, V_{BE(off)} = 3.8 \text{ V},$		35	ns
$t_d$	Delay Time	$I_C = 500 \text{ mA}, I_{B1} = 50 \text{ mA}$		10	ns
$t_r$	Rise Time			30	ns
$t_{off}$	Turn-off Time	$V_{CC} = 30 \text{ V}, I_C = 500 \text{ mA}$		60	ns
$t_s$	Storage Time	$I_{B1} = I_{B2} = 50 \text{ mA}$		50	ns
$t_f$	Fall Time			30	ns

\*Pulse Test: Pulse Width  $\leq 300 \text{ } \mu\text{s}$ , Duty Cycle  $\leq 1.0\%$

TN3725A / MMPQ3725

DC Typical Characteristics

Typical Pulsed Current Gain vs Collector Current

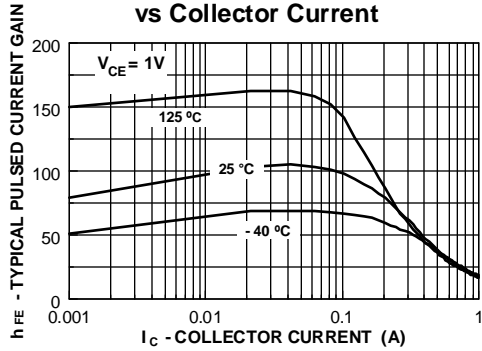

Collector-Emitter Saturation Voltage vs Collector Current

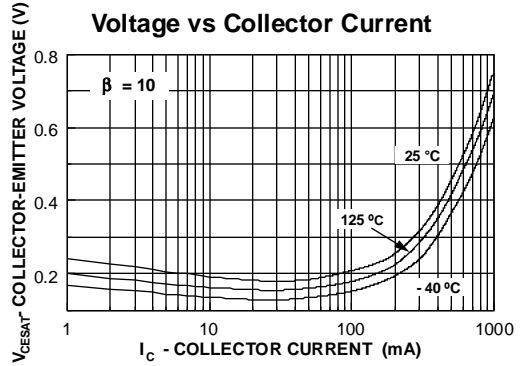

Base-Emitter Saturation Voltage vs Collector Current

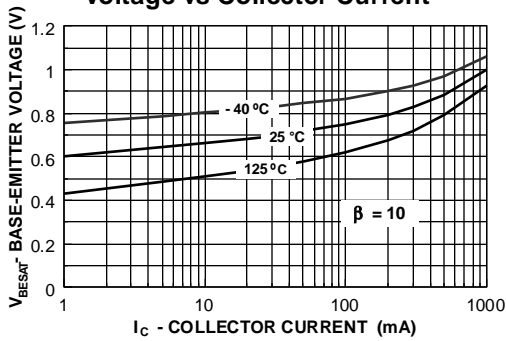

Base-Emitter ON Voltage vs Collector Current

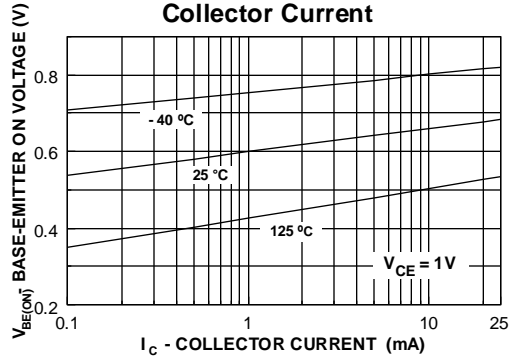

Collector-Cutoff Current vs Ambient Temperature

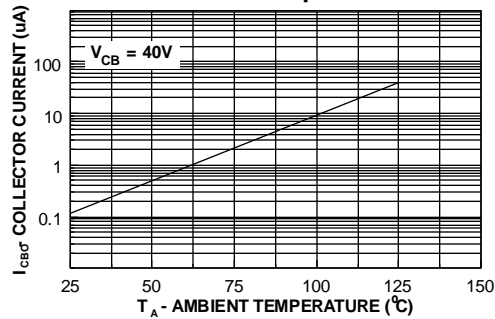

# NPN Switching Transistor

(continued)

TN3725A / MMPO3725

## AC Typical Characteristics

Input/Output Capacitance vs. Reverse Bias

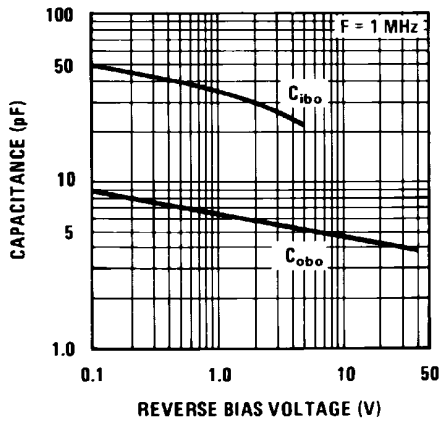

Contours of Constant Bandwidth Product ( $f_T$ )

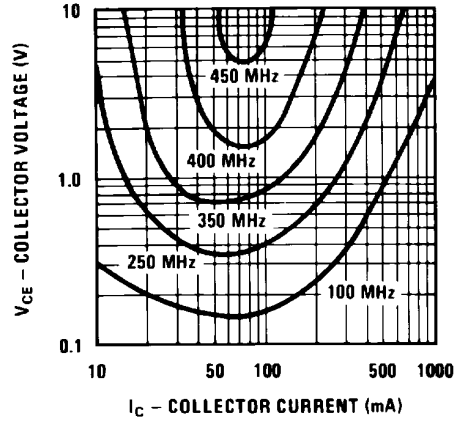

Switching Time vs. Collector Current

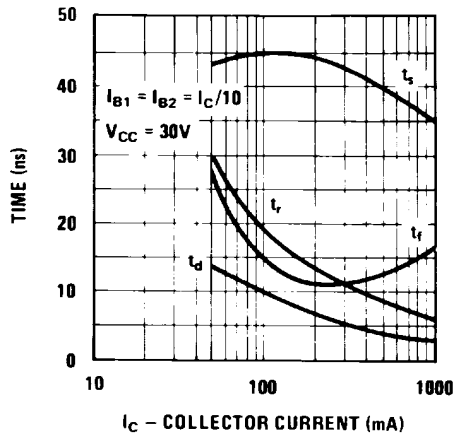

Turn On / Turn Off Times vs. Collector Current

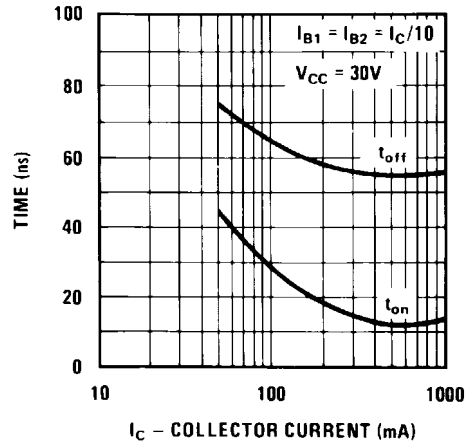

Switching Times vs. Ambient Temperature

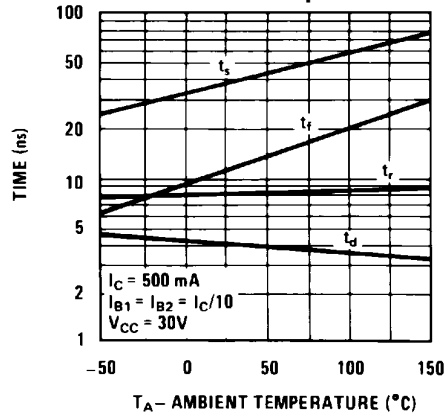

Delay Time vs. Turn On Base Current and Reverse Base-Emitter Voltage

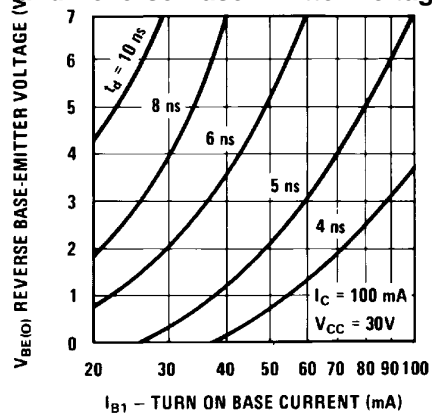

AC Typical Characteristics (continued)

Rise Time vs. Collector and Turn On Base Currents

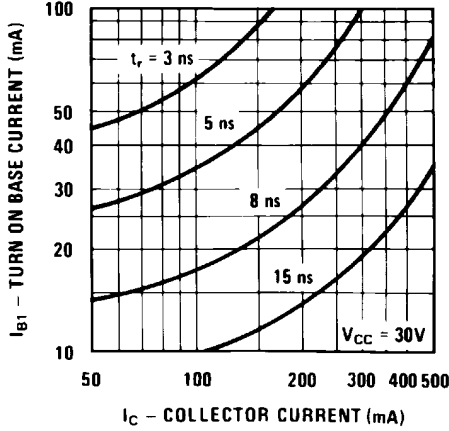

Storage Time vs. Turn On and Turn Off Base Currents

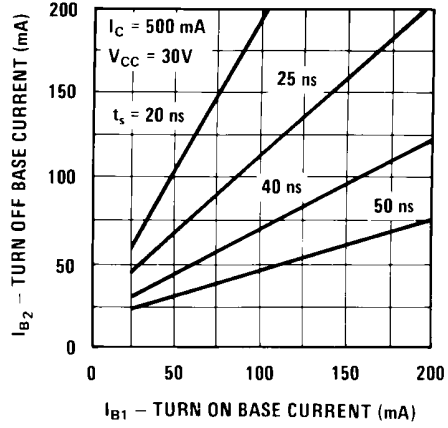

Storage Time vs. Turn On and Turn Off Base Currents

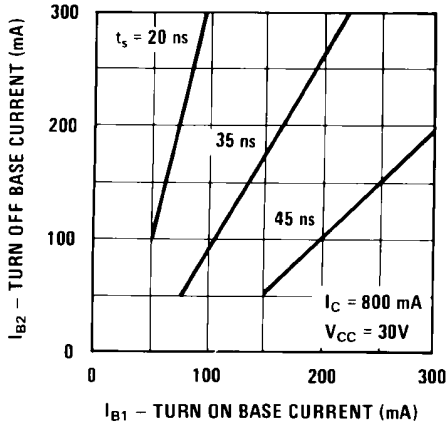

Storage Time vs. Turn On and Turn Off Base Currents

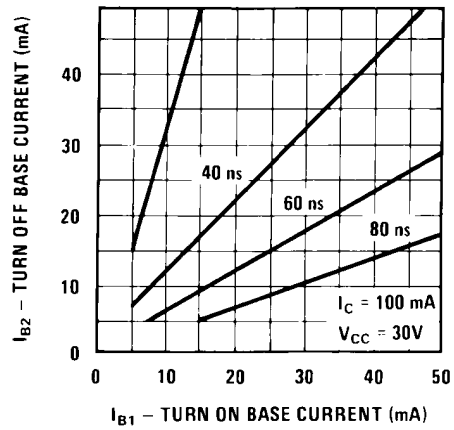

Fall Time vs. Turn On and Turn Off Base Currents

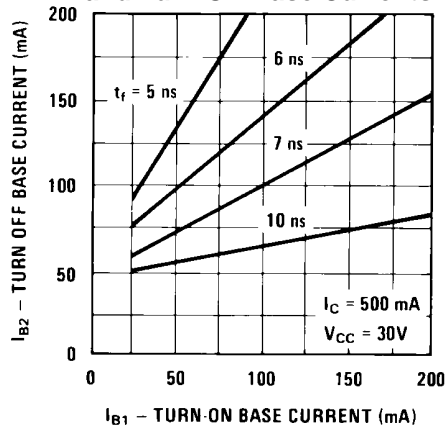

**NPN Switching Transistor**  
(continued)

**AC Typical Characteristics** (continued)

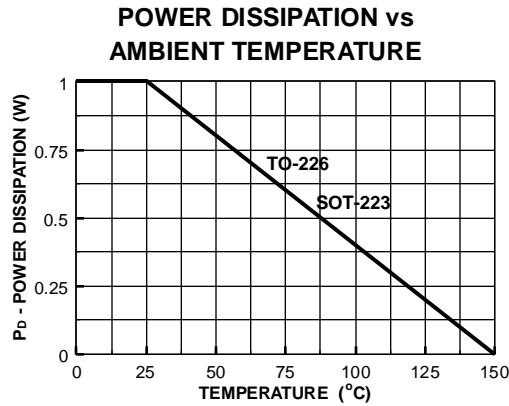
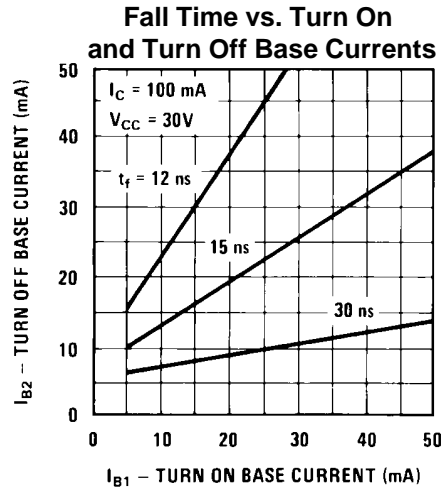
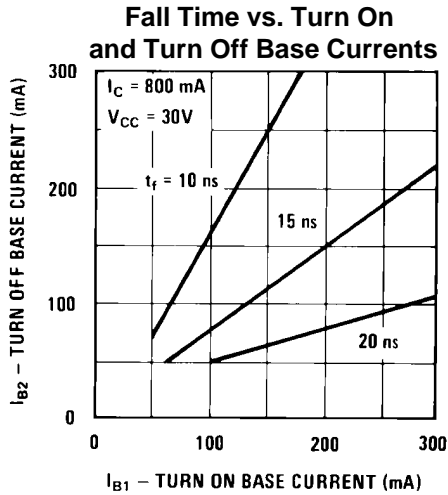

**Test Circuit**

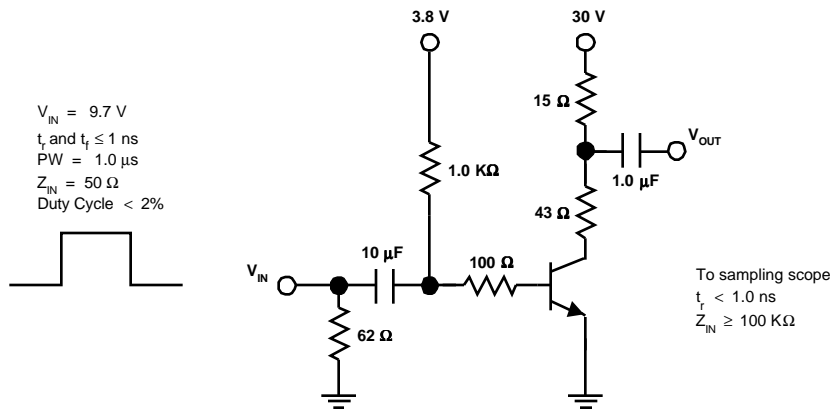

**FIGURE 1: Switching Time Test Circuit**  
( $I_C = 500 \text{ mA}$ ,  $I_{B1} = 50 \text{ mA}$ ,  $I_{B2} = 50 \text{ mA}$ )



## Стандарт Электрон Связь

Мы молодая и активно развивающаяся компания в области поставок электронных компонентов. Мы поставляем электронные компоненты отечественного и импортного производства напрямую от производителей и с крупнейших складов мира.

Благодаря сотрудничеству с мировыми поставщиками мы осуществляем комплексные и плановые поставки широчайшего спектра электронных компонентов.

Собственная эффективная логистика и склад в обеспечивает надежную поставку продукции в точно указанные сроки по всей России.

Мы осуществляем техническую поддержку нашим клиентам и предпродажную проверку качества продукции. На все поставляемые продукты мы предоставляем гарантию .

Осуществляем поставки продукции под контролем ВП МО РФ на предприятия военно-промышленного комплекса России , а также работаем в рамках 275 ФЗ с открытием отдельных счетов в уполномоченном банке. Система менеджмента качества компании соответствует требованиям ГОСТ ISO 9001.

Минимальные сроки поставки, гибкие цены, неограниченный ассортимент и индивидуальный подход к клиентам являются основой для выстраивания долгосрочного и эффективного сотрудничества с предприятиями радиоэлектронной промышленности, предприятиями ВПК и научно-исследовательскими институтами России.

С нами вы становитесь еще успешнее!

### Наши контакты:

**Телефон:** +7 812 627 14 35

**Электронная почта:** [sales@st-electron.ru](mailto:sales@st-electron.ru)

**Адрес:** 198099, Санкт-Петербург,  
Промышленная ул, дом № 19, литера Н,  
помещение 100-Н Офис 331