

Switch Mode Power Supply S8TS

CSM_S8TS_DS_E_6_1

Block-type Switch Mode Power Supply That Mounts to DIN Rail

- One model covers 30 to 120 W (12-V models).
- One model covers 60 to 240 W (24-V models).
- Easy creation of multi-power supply configurations with different output power supplies connected together (5-V, 12-V, and 24-V models).
- Improve power supply system reliability by creating N+1 redundant systems (12-V and 24-V models).
- RoHS-compliant
- Input conditions: 80 to 370 VDC supported for DC input too (EC Directives and safety standards are not applicable.)



Refer to *Safety Precautions for All Power Supplies and Safety Precautions* on page 12.

Model Number Structure

Model Number Legend

Note: Not all combinations are possible. Refer to *List of Models* in *Ordering Information*, below.

S8TS- -

1 2 3 4

1. Capacity

025: 25 W
030: 30 W
060: 60 W

2. Output Voltage

05: 5 V
12: 12 V
24: 24 V

3. Structure

None: Screw terminals
F: Connector terminals

4. Bus Line Connectors

None: Basic Block only
E1: One S8T-BUS01 and one S8T-BUS02 included as accessories

Ordering Information

Note: For details on normal stock models, contact your nearest OMRON representative.

List of Models

Basic Block

Output voltage	Output current	Screw terminal Model		Connector terminal Model (See note 3.)	
		With Bus Line Connectors (See note 1.)	Without Bus Line Connectors (See note 2.)	With Bus Line Connectors (See note 1.)	Without Bus Line Connectors (See note 2.)
5 V	5 A	---	S8TS-02505	---	S8TS-02505F
12 V	2.5 A	S8TS-03012-E1	S8TS-03012	S8TS-03012F-E1	S8TS-03012F
24 V	2.5 A	S8TS-06024-E1	S8TS-06024	S8TS-06024F-E1	S8TS-06024F

Bus Line Connector

Specifications	Number of Connectors	Model number
Connector with DC line connected (For parallel operation)	1 Connector	S8T-BUS01
	10 Connectors (See note 4.)	S8T-BUS11
Connector with DC line not connected (Not for parallel operation)	1 Connector	S8T-BUS02
	10 Connectors (See note 5.)	S8T-BUS12

Note: 1. One S8T-BUS01 Connector and one S8T-BUS02 Connector are included as accessories.

2. Bus Line Connectors are ordered separately. When connecting Power Supplies with Bus Line Connectors, order the Bus Line Connectors separately.
3. Attached connectors: 2ESDPLM-05P (for output terminal) and 3ESDPLM-03P (for input terminal) made by DINKLE ENTERPRISE.
4. One package contains 10 S8T-BUS01 Connectors.
5. One package contains 10 S8T-BUS02 Connectors.

Specifications

■ Ratings/Characteristics

12/24-V Models (Basic Block: S8TS-06024□/S8TS-03012□)

Item		Single operation	Parallel operation	
Efficiency (TYP.)		24-V models: 80% TYP. ; 12-V models: 73% TYP. (with rated input, 100% load)		
Input	Voltage (See note 1.)	Ratings: 100 to 240 VAC (Allowable range: 85 to 264 VAC, 80 to 370 VDC (See note 8.))		
	Frequency (See note 1.)	50/60 Hz (47 to 63 Hz)		
	Current	100 V input	24-V models: 1.0 A max. 12-V models: 0.7 A max.	24-V models: 1.0 A × (No. of Blocks) max. 12-V models: 0.7 A × (No. of Blocks) max.
		200 V input	24-V models: 0.5 A max. 12-V models: 0.4 A max.	24-V models: 0.5 A × (No. of Blocks) max. 12-V models: 0.4 A × (No. of Blocks) max.
	Power factor		24-V models: 0.9 min.; 12-V models: 0.8 min. (with rated input, 100% load)	
	Harmonic current emissions		Conforms to EN61000-3-2	
	Leakage current	100 V input	0.35 mA max.	0.35 mA × (No. of Blocks) max.
		240 V input	0.7 mA max.	0.7 mA × (No. of Blocks) max.
	Inrush current (See note 5.)	100 V input	17.5 A max. (for a cold start at 25°C)	17.5 A × (No. of Blocks) max. (for a cold start at 25°C)
		200 V input	35 A max. (for a cold start at 25°C)	35 A × (No. of Blocks) max. (for a cold start at 25°C)
Output (See note 4.)	Voltage adjustment range		24-V models: 22 to 28 V 12-V models: 12 V ±10% (with V.ADJ) (See note 2.)	
	Ripple		2% (p-p) max.	
	Input variation influence		0.5% max. (with 85 to 264 VAC input, 100% load)	
	Load variation influence		2% max. (with rated input, 10% to 100% load) 3% max. (with rated input, 10% to 100% load)	
	Temperature variation influence		0.05%/°C max. (with rated input and output)	
	Startup time		1,000 ms max. (with 100/200 VAC, rated input)	
Hold time (See note 5.)		20 ms min. (with 100/200 VAC, rated input)		
Additional functions	Overload protection (See note 5.)		105% to 140% of rated load current, voltage drop, automatic reset 100% to 140% of rated load current, voltage drop, automatic reset	
	Overvoltage protection (See notes 5 and 6.)		Yes	
	Parallel operation		Yes (Up to 4 Blocks)	
	N+1 redundant system		Yes (Up to 5 Blocks)	
	Series operation		Yes	
	Undervoltage indicator (See note 5.)		Yes (color: red)	
Undervoltage detection output (See note 5.)		Yes (open collector output), 30 VDC max., 50 mA max.		
Other	Ambient operating temperature (See note 5.)		Refer to the derating curve in <i>Engineering Data</i> (with no icing or condensation).	
	Storage temperature		-25 to 65°C	
	Ambient operating humidity		25% to 85% (Storage humidity: 25% to 90%)	
	Dielectric strength		3.0 kVAC for 1 minute (between all inputs and all outputs; detection current: 20 mA)	
			2.0 kVAC for 1 minute (between all inputs and PE terminal; detection current: 20 mA)	
	Insulation resistance		1.0 kVAC for 1 minute (between all outputs and PE terminal; detection current: 20 mA)	
			100 MΩ min. (between all outputs, and all inputs/PE terminal) at 500 VDC	
	Vibration resistance (See note 7.)		10 to 55 Hz, 0.375-mm single amplitude for 2 h each in X, Y, and Z directions	
	Shock resistance (See note 7.)		150 m/s ² , 3 times each in ±X, ±Y, and ±Z directions	
	Output indicator		Yes (color: green)	
	EMI (See note 8.)	Conducted Emission	Conforms to EN61204-3 EN55011 Class B and based on FCC Class A (See note 9.)	
		Radiated Emission	Conforms to EN61204-3 EN55011 Class B (See note 9.)	
	EMS (See note 8.)		Conforms to EN61204-3 High severity levels (See note 9.)	
	Approved standards (See note 8.)		24V model	
			UL Listed: UL508 (Listing, Class2 Output: Per UL1310) (See note 3.) UL UR: UL60950-1 (Recognition) cUL Listed: CSA C22.2 No.107.1 (Class2 Output: Per CSA C22.2 No.223) (See note 3.) cUR: CSA C22.2 No.60950-1 EN/VDE: EN50178 (=VDE0160) , EN60950-1 (=VDE0805 Teil1)	
	Weight		12V model	
UL Listed: UL508 (Listing) UL UR: UL60950-1 (Recognition) cUL Listed: CSA C22.2 No.107.1 cUR: CSA C22.2 No.60950-1 EN/VDE: EN50178 (=VDE0160) , EN60950-1 (=VDE0805 Teil1)				
Weight		450 g max.	450 g × (No. of Blocks) max.	

- Note:**
- Do not use an inverter output for the Power Supply. Inverters with an output frequency of 50/60 Hz are available, but the rise in the internal temperature of the Power Supply may result in ignition or burning.
 - Refer to page 7 for details on adjusting the output voltage for parallel operation. If set to less than -10%, the undervoltage detection function may operate. Ensure that the output capacity and output current after adjustment do not exceed the rated output capacity and rated output current respectively. Adjusting V.ADV may cause the output voltage to exceed the voltage range. When adjusting the output voltage, confirm the actual output voltage from the Power Supply and be sure that the load is not damaged.
 - Class 2 approval does not apply to parallel operation.
 - The output current is specified at power output terminals.
 - Refer to the *Engineering Data* on page 8 for details.
 - To reset the protection, turn OFF the input power for one minute or longer and then turn it back again.
 - Be sure to mount End Plates (PFP-M) on both ends of the Power Supply.
 - The range for compliance with EC Directives and safety standards (UL, EN, etc.) is 100 to 240 VAC (85 to 264 VAC).
 - The noise level depends on the wiring method and other factors. Insert one clamp filter (the ZCAT2436-1330A from TDK) as a noise countermeasure on the input line and ground line combined.

5-V Models (Basic Block: S8TS-02505□)

Item		Single operation	
Efficiency (typical)		73% TYP. (with rated input, 100% load)	
Input	Voltage (See note 1.)	Ratings: 100 to 240 VAC (Allowable range: 85 to 264 VAC, 80 to 370 VDC (See note 8.))	
	Frequency (See note 1.)	50/60 Hz (47 to 63 Hz)	
	Current	100 V input	0.7 A max.
		200 V input	0.4 A max.
	Power factor	0.8 min. (with rated input, 100% load)	
	Harmonic current emissions	Conforms to EN61000-3-2	
	Leakage current	100 V input	0.35 mA max.
		240 V input	0.7 mA max.
Inrush current (See note 5.)	100 V input	17.5 A max. (for a cold start at 25°C)	
	200 V input	35 A max. (for a cold start at 25°C)	
Output (See note 3.)	Voltage adjustment range	5 V ± 10% (with V. ADJ) (See note 2.)	
	Ripple	2% (p-p) max.	
	Input variation influence	0.5% max. (with 85 to 264 VAC input, 100% load)	
	Temperature variation influence	0.05%/°C max. (with rated input and output)	
	Load variation influence	1.5% max. (with rated input, 10% to 100% load)	
	Startup time (See note 4.)	1,000 ms max. (with 100/200 VAC, rated input)	
	Hold time (See note 4.)	20 ms min. (with 100/200 VAC, rated input)	
Additional functions	Overload protection (See note 4.)	105% to 140% of rated load current, voltage drop, automatic reset	
	Overvoltage protection (See notes 4 and 5.)	Yes	
	Parallel operation	No	
	N+1 redundant system	No	
	Series operation	Yes (with the external diode)	
	Undervoltage indicator (See note 4.)	Yes (color: red)	
	Undervoltage detection output (See note 4.)	Yes (open collector output), 30 VDC max., 50 mA max.	
Other	Ambient operating temperature (See note 4.)	Refer to the derating curve in <i>Engineering Data</i> .	
	Storage temperature	-25 to 65°C (with no icing or condensation)	
	Ambient operating humidity	25% to 85%, Storage: 25% to 90%	
	Dielectric strength	3.0 kVAC, 50/60 Hz for 1 minute (between all inputs and all outputs; detection current: 20 mA)	
		2.0 kVAC, 50/60 Hz for 1 minute (between all inputs and PE terminal; detection current: 20 mA)	
		1.0 kVAC for 1 minute (between all outputs and PE terminal; detection current: 20 mA)	
	Insulation resistance	100 MΩ min. (between all outputs and inputs/PE terminal) at 500 VDC	
	Vibration resistance (See note 6.)	10 to 55 Hz, 0.375-mm single amplitude for 2 h each in X, Y, and Z directions	
	Shock resistance (See note 6.)	150 m/s ² , 3 times each in ±X, ±Y, and ±Z directions	
	Output indicator	Yes (color: green)	
	EMI (See note 7.)	Conducted Emission	Conforms to EN61204-3 EN55011 Class B and based on FCC Class A
		Radiated Emission	Conforms to EN61204-3 EN55011 Class B
	EMS (See note 7.)	Conforms to EN61204-3 High severity levels	
	Approved standards (See note 7.)	UL Listed: UL508 (Listing) UL UR: UL60950-1 (Recognition) cUL Listed: CSA C22.2 No.107.1 cUR: CSA C22.2 No.60950-1 EN/VDE: EN50178 (=VDE0160), EN60950-1 (=VDE0805 Teil1)	
Weight	450 g max.		

- Note:**
- Do not use an inverter output for the Power Supply. Inverters with an output frequency of 50/60 Hz are available, but the rise in the internal temperature of the Power Supply may result in ignition or burning.
 - If set to less than -10%, the undervoltage detection function may operate. Ensure that the output capacity and output current after adjustment do not exceed the rated output capacity and rated output current respectively. If the output voltage adjuster (V. ADJ) is turned, the voltage will increase by more than 10% of the output voltage, confirm the actual output voltage from the Power Supply and be sure that the load is not damaged.
 - The output current is specified at power output terminals.
 - Refer to the *Engineering Data* on page 8 for details.
 - To reset the protection, turn OFF the input power for one minute or longer and then turn it back again.
 - Be sure to mount End Plates (PFP-M) on both ends of the Power Supply.
 - The range for compliance with EC Directives and safety standards (UL, EN, etc.) is 100 to 240 VAC (85 to 264 VAC).

Reference Value

Item	Value	Definition
Reliability (MTBF)	250,000 hrs min.	MTBF stands for Mean Time Between Failures, which is calculated according to the probability of accidental device failures, and indicates reliability of devices. Therefore, it does not necessarily represent the life of the product.
Life expectancy	10 yrs min.	The life expectancy indicates average operating hours under the ambient temperature of 40°C and a load rate of 50%. Normally this is determined by the life expectancy of the built-in aluminum electrolytic capacitor.

Connections

■ Block Diagrams

S8TS-06024□ and S8TS-03012□

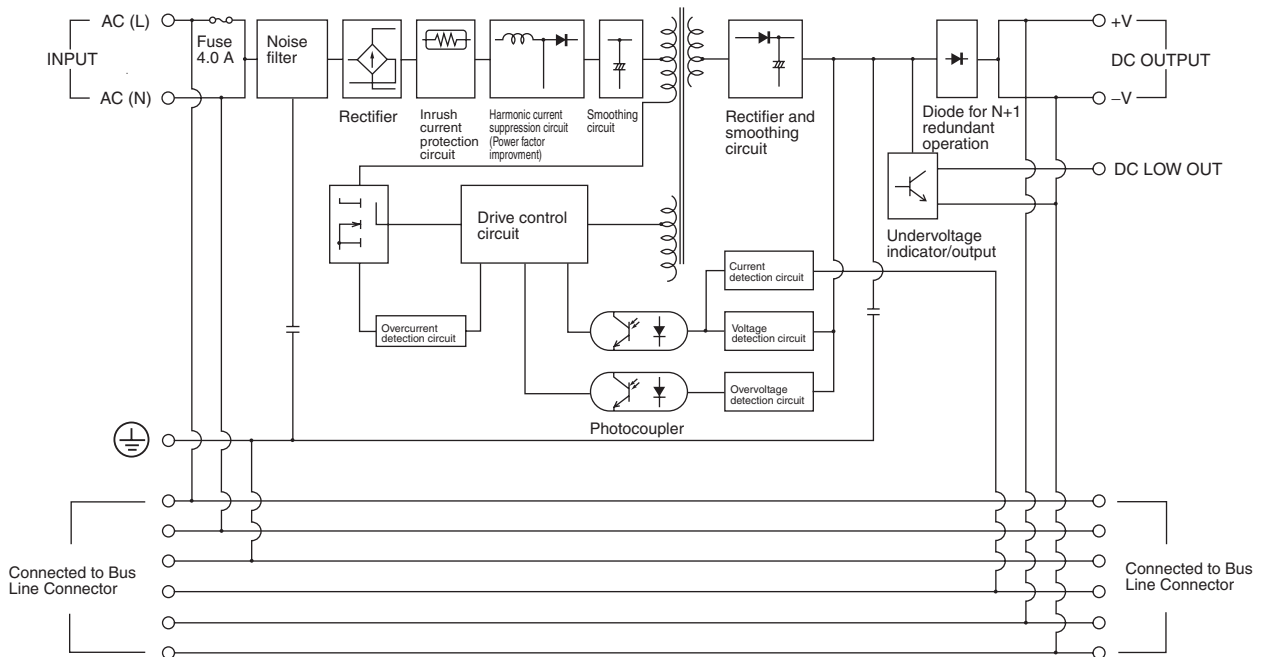

S8TS-02505□

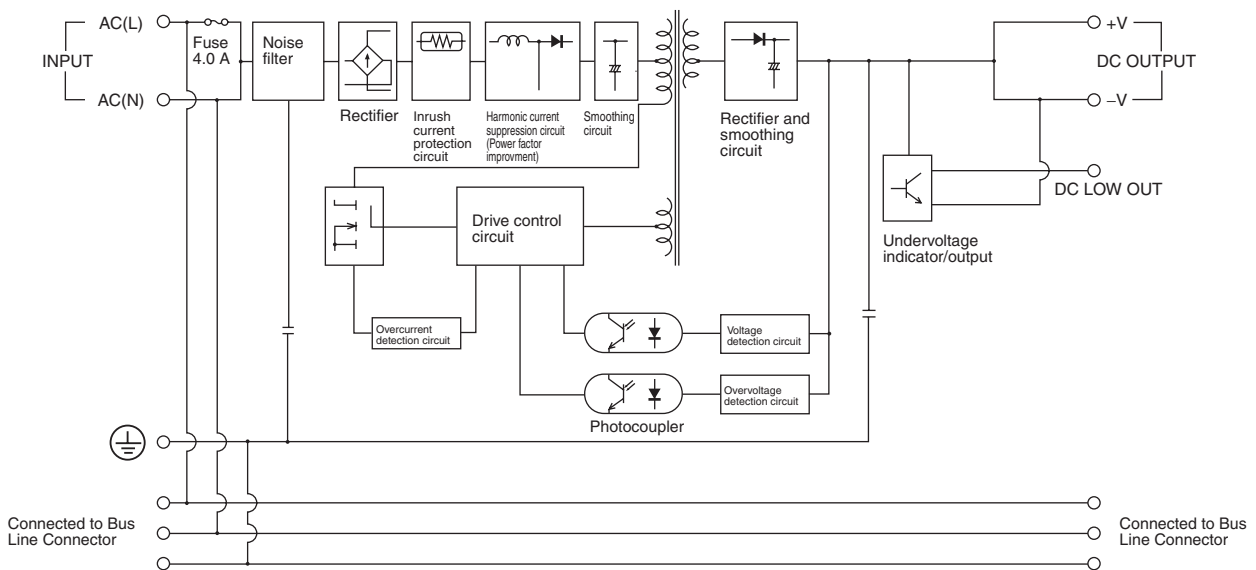

Construction and Nomenclature

■ Nomenclature

Basic Blocks with Screw Terminals (S8TS-□□□□□□)

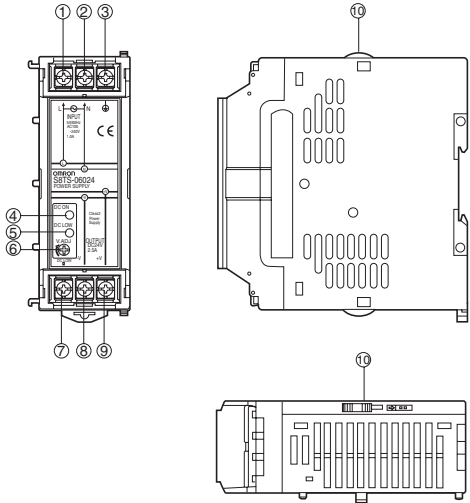

Basic Blocks with Connector Terminals (S8TS-□□□□□□F)

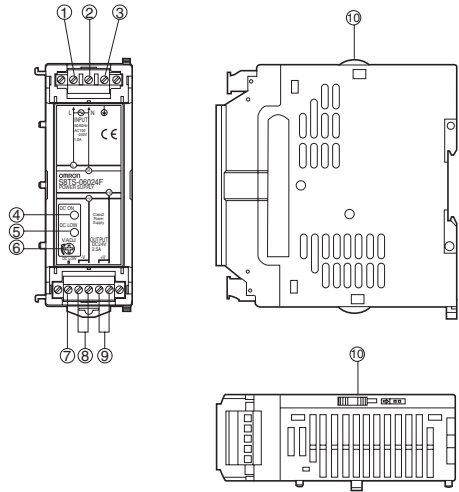

- ① **AC Input Terminal (L):** Connect an input line to this terminal.
- ② **AC Input Terminal (N):** Connect an input line to this terminal.
- ③ **Protective Earth (PE) Terminal (⊖):** Connect a ground line to this terminal.
- ④ **Output Indicator (DC ON: Green):** Lights while DC output is ON.
- ⑤ **Undervoltage Indicator (DC LOW: Red):** Lights when the voltage at the output terminal drops.
- ⑥ **Output Voltage Adjuster (V.ADJ):** Use to adjust the output voltage.
- ⑦ **Undervoltage Detection Output (DC LOW OUT):** Open Collector output
- ⑧ **DC Output Terminal (-V):** Connect load lines to this terminal.
- ⑨ **DC Output Terminal (+V):** Connect load lines to this terminal.
- ⑩ **Slider:** Slide to the lock side when connecting. Unlock the slider when disconnecting.

Connector with DC Line Connected S8T-BUS01 Bus Line Connector

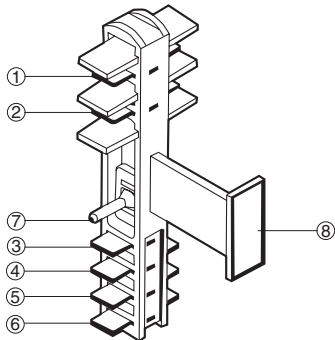

Connector with DC Line Not Connected S8T-BUS02 Bus Line Connector

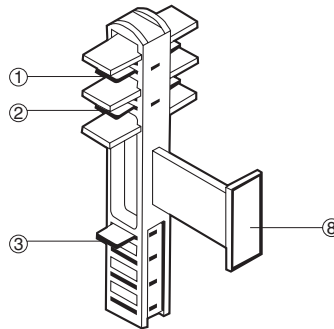

- ① AC Input Terminal (L)
- ② AC Input Terminal (N)
- ③ Protective Earth (PE) Terminal (⊖)
- ④ Parallel Operation Signal Terminal
- ⑤ DC Output Terminal (+V)
- ⑥ DC Output Terminal (-V)
- ⑦ Selector
- ⑧ Connection Status Indicator

Operation

Application Methods

Increasing Output Capacity

Example for 24-V Models

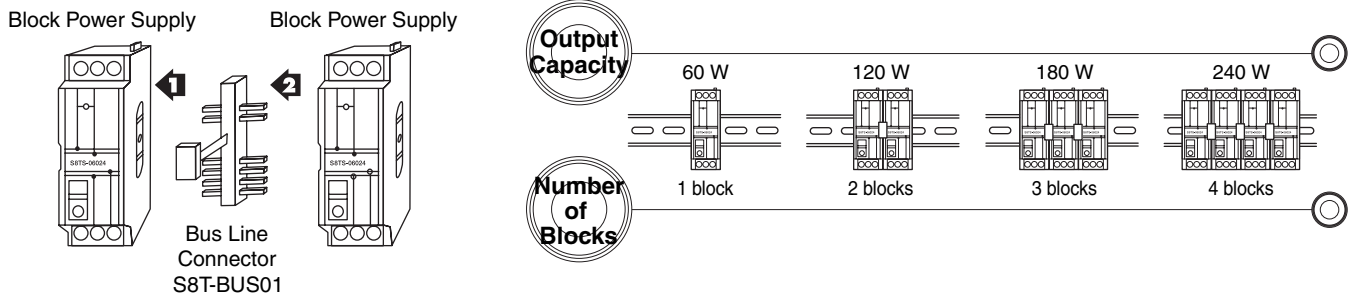

Configuring Multiple Outputs

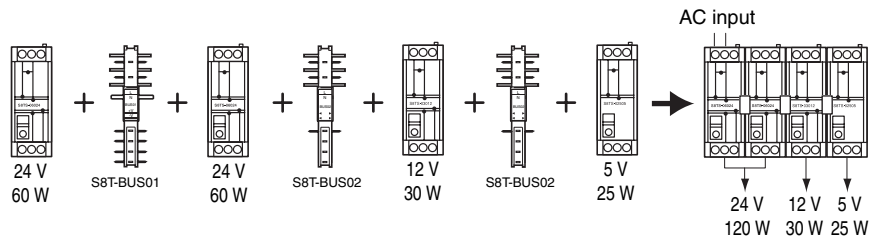

Maximum Number of Blocks That Can Be Linked

Basic Blocks can be linked using Bus Line Connectors.

Increasing Output Capacity

Models	Number of Blocks	N+1 Redundant System
S8TS-02505□	No	No
S8TS-03012□	Up to 4 Blocks	Up to 5 Blocks
S8TS-06024□	Up to 4 Blocks	Up to 5 Blocks

N+1 Redundant Systems

To ensure stable operation when there is a failure in one of the Blocks, use within the derating curve for N+1 redundant systems.

Multi-output Power Supply

Up to 4 Basic Blocks with different output voltage specifications can be linked.

Selecting Bus Line Connectors

Select Bus Line Connectors according to the linking method as follows:

Using Parallel Operation

Use the S8T-BUS01 (DC line connected). (See Figure 1.)

The S8T-BUS01 Bus Line Connector is equipped with a selector to prevent erroneous connection of Blocks with different output voltage specifications. Slide the selector to the output voltage for parallel operation.

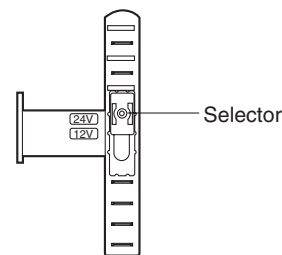

Note: Parallel operation is enabled by using a current balance function. For the current balance function to operate, the S8T-BUS01 must be used.

Not Using Parallel Operation

Use the S8T-BUS02 (DC line not connected). (See Figure 2.)

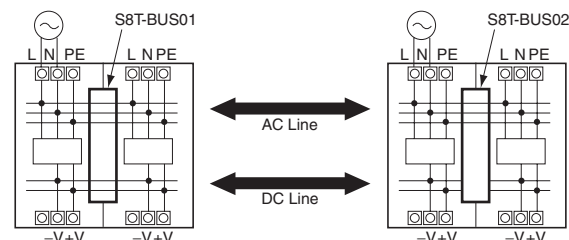

Figure 1: DC line connected (parallel connection)

Figure 2: DC line not connected (isolated connection)

Mounting and Removing Bus Line Connectors

Pay attention to the following points to maintain electrical characteristics.

Do not insert/remove the Connectors more than 20 times.

Do not touch the Connector terminals.

To remove the Connectors, insert a flat-bladed screwdriver alternately at both ends.

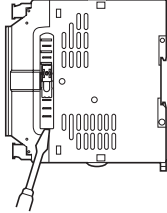

Wiring Linked Blocks

When linking Blocks together, wire input lines to one Basic Block only, otherwise inputs may be shorted internally resulting in damage to the Block.

Do not wire inputs to more than one

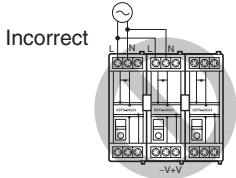

Do not cross-wire Blocks or wire between a Block and another device. If the current exceeds the rated current, Bus Line Connectors may be damaged.

Do not use cross-wire Blocks.

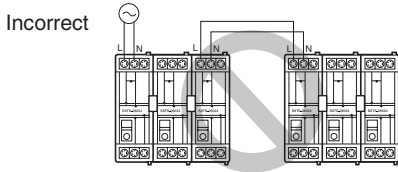

When Basic Blocks are linked together, it is necessary to wire the PE terminal of only one Basic Block, not all the Blocks.

Series Operation and ± Output

Using 2 Basic Blocks enables series operation and the use of ± output. An external diode is not required for S8TS-06024□ and S8TS-03012□ models, but is required for S8TS-02505□ models. Use the following as a rough guide for selecting the diode.

Type	Schottky barrier diode
Withstand voltage (V_{RRM})	At least twice the rated output voltage
Current with normal direction (I_F)	At least twice the rated output current

Note: Series operation is possible with different specifications, but the current that flows to the load must not exceed the rated output current of any Block.

Series Operation

24/12-V models 5-V models

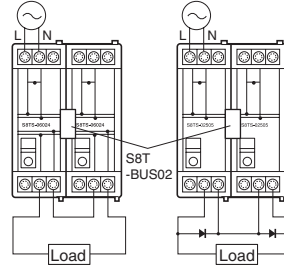

± Output

24/12-V models 5-V models

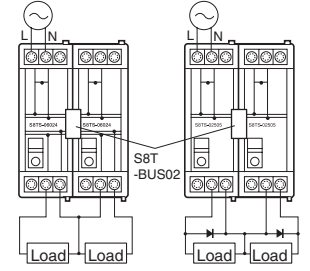

Adjusting Output Voltage for Parallel Operation

The Blocks are factory-set to the rated output voltage. When adjusting output voltages, set the same values for Blocks with output voltage adjuster (V.ADJ) before linking them together. Adjust the set values within the limits given in the following table.

Model number	Difference between output voltages
S8TS-03012□	0.12 V max.
S8TS-06024□	0.24 V max.

Do not adjust output voltages after Blocks are linked together. The output voltage may become unstable.

Inrush Current

The inrush current per Basic Block is 17.5 A max. at 100 VAC and 35 A max. at 200 VAC. When N Blocks are linked together, the inrush current will be equal to N times that for 1 Basic Block. Be sure to use a fuse with the appropriate fusing characteristics or a breaker with the appropriate tripping characteristics.

Leakage Current

The leakage current per Basic Block is 0.35 mA max. at 100 VAC and 0.7 mA max. at 240 VAC. When N Blocks are linked together, the leakage current will be equal to N times that for 1 Basic Block.

Mounting

Mounting Direction

Standard mounting	Yes
Face-up mounting	No
Other mounting methods	No

Use standard mounting only. Using any other mounting method will prevent proper heat dissipation and may result in deterioration or damage of internal parts.

Correct

Incorrect

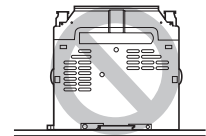
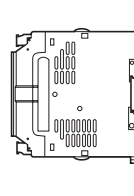

Standard mounting

Face-up mounting

Engineering Data

Derating Curves

Parallel Operation and Side-by-side Mounting

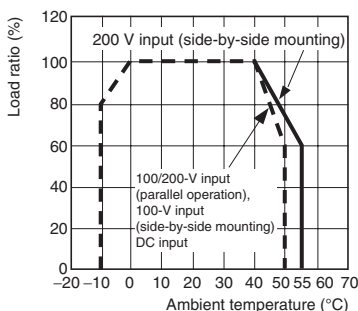

Single Operation with Spaces between Blocks

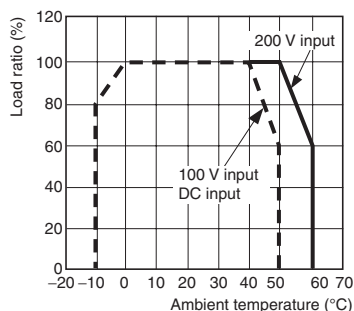
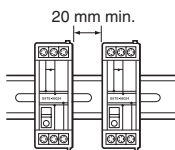

N+1 Redundant System

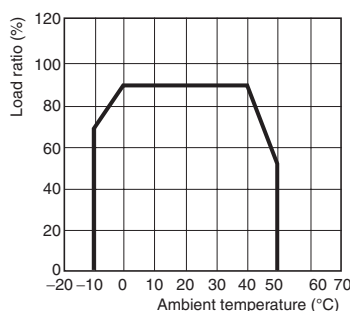
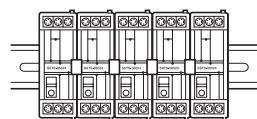

Note: 1. If there is a derating problem, use forced air-cooling.

2. The ambient temperature is specified for a point 50 mm below the Power Supply.

3. Use the rated output for single operation multiplied by N as a reference for the load ratio for an N+1 redundant system.

4. DC Input: If the input voltage is less than 100 VDC, reduce the load to 0.8 or less times the values given in the above derating curves.

Overload Protection

The Power Supply is provided with an overload protection function that protects the Power Supply from possible damage by overcurrent. When the output current rises above 105% min. of the rated current (100% min. of the rated current for parallel operation), the protection function is triggered, automatically decreasing the output voltage. When the output current falls within the rated range, the overload protection function is automatically cleared.

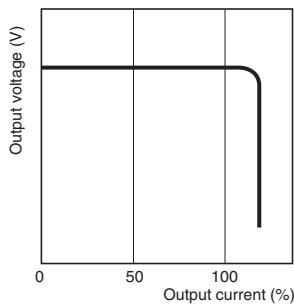

The values shown in the above diagram are for reference only.

Note: Internal parts may occasionally deteriorate or damaged if a short-circuited or overcurrent continues for 20 min. or longer.

Overvoltage Protection

An overvoltage protection function is provided so that excessive voltage is not applied to the load, e.g., if the feedback circuit in the Power Supply fails. When a voltage that is approximately 120% of the rated voltage or more is output, the output voltage is shut OFF. Reset the input power by turning it OFF for at least 1 minute and then turning it back ON again.

12-V and 5-V Models

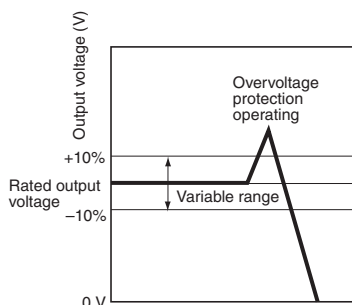

24-V Models

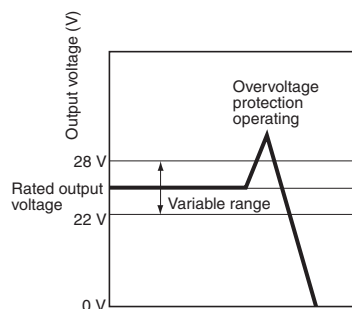

The values shown in the above diagrams are for reference only.

Note: Do not turn ON the input power again until the cause of the overvoltage has been removed.

Inrush Current, Startup Time, Hold Time

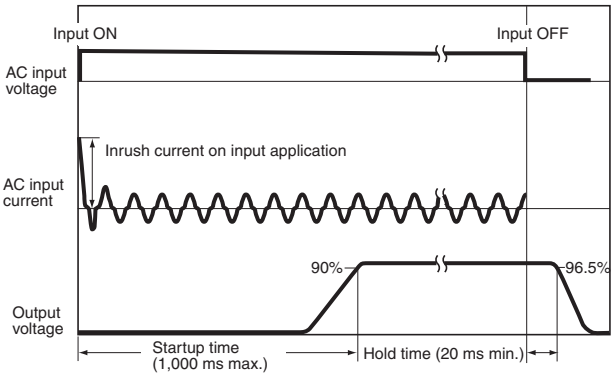

Undervoltage Indicator and Undervoltage Detection Output

When a drop in the output voltage is detected, the red indicator (DC LOW) lights and transistor (DC LOW: OUT) output turns ON to provide external notification of the error. The detection voltage is set to approximately 80% (75% to 90%) of the rated output voltage.

Status of indicator	Voltage status	Output status (See note 2.)
Green lit: ● ODC ON Red not lit: ○ DC LOW	Approx. 80% min. of the rated output voltage	ON
Green lit: ● DC ON (See note 3.) Red lit: ● DC LOW	Approx. 80% max. of the rated output voltage	OFF
Green not lit: ○ DC ON Red not lit: ○ DC LOW	Close to 0 V	OFF

- Note:**
- This function monitors the voltage at the power output terminals. For accurate confirmation of the output status, measure the voltage at the output terminal.
 - Transistor output: Open collector
30 VDC max., 50 mA max.
ON residual voltage: 2 V max.
OFF leakage current: 0.1 mA max.
 - The indicators become dimmer as the output voltage approaches 0 V.

Undervoltage Detection Output

Blocks with Screw Terminals

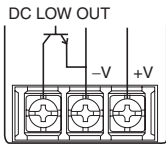

Blocks with Connector Terminals

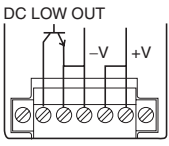

Dimensions

Note: All units are in millimeters unless otherwise indicated.

S8TS-□□□□□

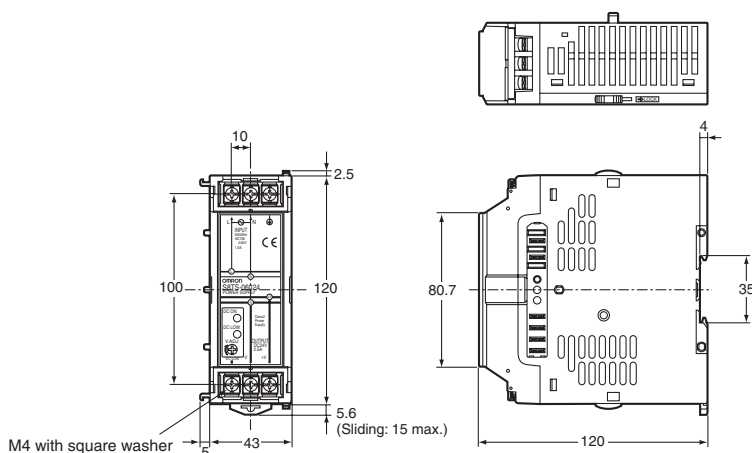
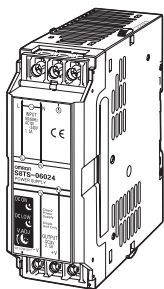

S8TS-□□□□□F

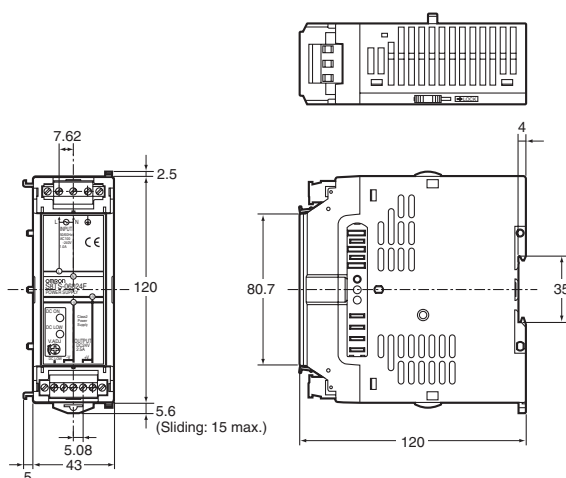
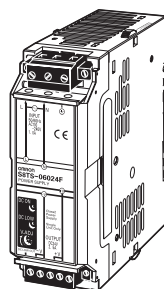

■ DIN Rails (Order Separately) Mounting Rails (Material: Aluminum)

PFP-100N
PFP-50N

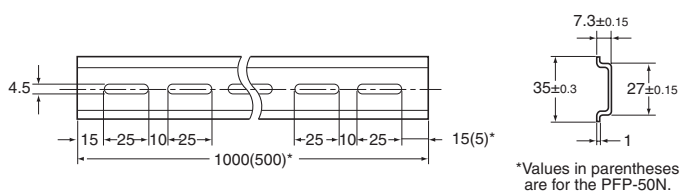
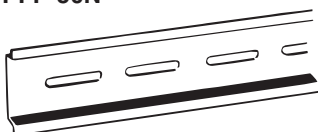

PFP-100N2

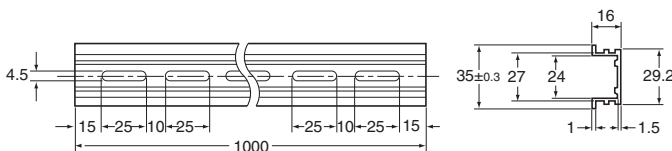
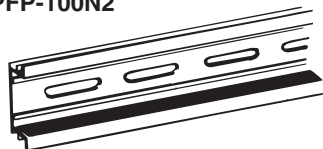

End Plate

PFP-M

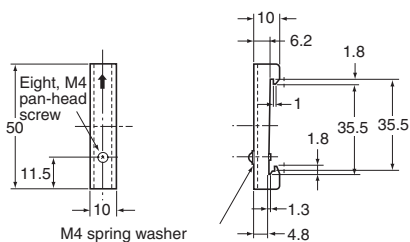
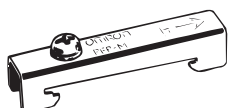

Application Examples

Standardization

Semiconductor manufacturing equipment



Electrical appliance manufacturers

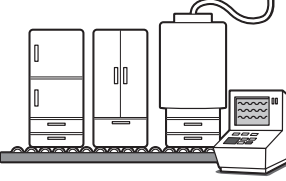

Machines with various models or equipment with various power supply specifications

Automobile manufacturers

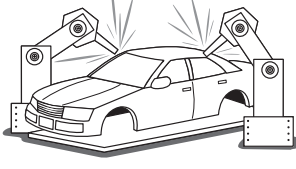

- Simplified designing and design changes.
- Reduced stock and reduced purchasing funds.

Power Supplies with Multiple Outputs

Packing machines

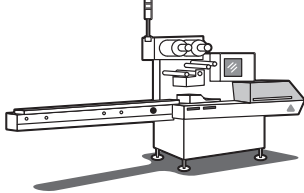

Conveyors

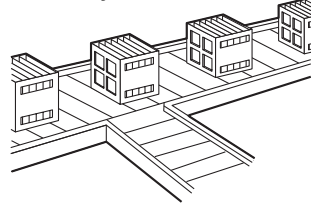

Equipment and systems that use multiple power supplies or multiple power supply outputs

Large control panels

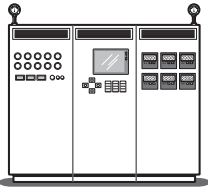

- Simplified creation of power supplies with multiple outputs.

N+1 Redundant Systems

Semiconductor utilities

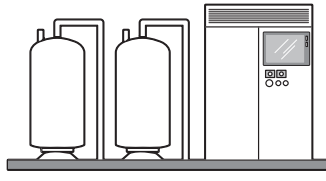

Process equipment

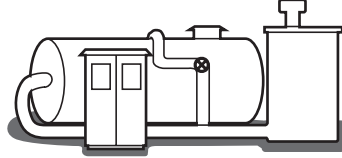

Process-control systems

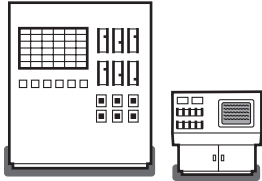

N+1 Redundancy

In an N+1 redundant system, N Power Supplies of the same model are linked in parallel connections and one additional Power Supply of the same model is added for redundancy. (N is 1 for a single operation system.) This setup increases system reliability.

S8TS Operation

No special settings are required for N+1 redundant operation with the S8TS. Just link Basic Blocks for redundant operation in parallel to enable N+1 redundant operation. A current balance function is used for S8TS N+1 redundant operation so that each Block provides the same current. If one Power Supply fails, the remaining Power Supplies share the load of the failed Power Supply, and operation continues with each Power Supply providing more current. The Power Supply that has failed can be identified by the output indicator, undervoltage indicator, and undervoltage detection output to enable replacing the Block with a normal Block. Always turn OFF the input power before replacing a Block. To increase Power Supply reliability, use only 90% or less of the maximum rated capacity for N Power Supplies even when N+1 Power Supplies are linked.

Output capacity during normal operation

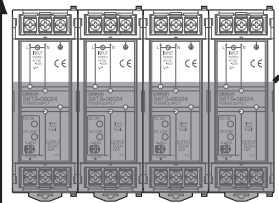



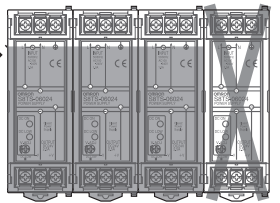



Output capacity when one Power Supply is down



Output capacity per Power Supply

Safety Precautions

Refer to *Safety Precautions for All Power Supplies*.

⚠ CAUTION	
<ul style="list-style-type: none"> Do not disassemble the product or touch internal parts during power-on. Electric shock may be caused. 	
<ul style="list-style-type: none"> Do not touch the product during power-on, and immediately after poweroff. Hot surface may cause heat injury. 	
<ul style="list-style-type: none"> Electrical shock or minor injury may occasionally occur. Do not touch the terminals while power is being supplied. Also, always attach the Terminal Cover after you complete wiring. While power is supplied, voltages up to 370 V are generated internally. The voltage can remain for 30 seconds after the power supply is turned OFF. 	
<ul style="list-style-type: none"> Do not remove any connector cover unless using bus line connectors. Electric shock may be caused. 	
<ul style="list-style-type: none"> Tighten the terminal screws with torque: 9.6 in-lb (1.08N-m), and tighten the connector screw and screw flange with torque: 2.7 in-lb (0.3N-m). Loose screws may cause fire. 	
<ul style="list-style-type: none"> Minor injury, fire, or device failure may occasionally occur. Do not allow any pieces of metal, conductors, or cuttings from installation work to enter the Power Supply. 	

■ Precautions for Safe Use

Mounting

Heat dissipation capacity may be decreased if a non-standard mounting method is used, occasionally resulting in damage to internal components. Use only the standard mounting method.

To improve the long-term reliability of devices, give due consideration to heat dissipation when mounting. With the S8TS, heat is dissipated by natural convection. Mount Blocks in a way that allows convection in the atmosphere around them.

Do not allow cuttings to enter the Power Supply during installation work.

Be sure to remove the sheet covering the Power Supply for machining before turning ON the power so that it does not interfere with heat dissipation.

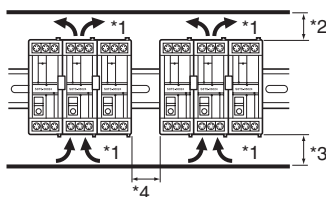

*1. Convection of air

*2. 75 mm min.

*3. 75 mm min.

*4. 10 mm min.

When cutting out holes for mounting, make sure that cuttings do not enter the interior of the products.

Wiring

Ground the product completely. Failure to do so could cause the electric shock or malfunction.

Ensure that input and output terminals are wired correctly.

Use the following material to the wire to be applied to the product for preventing from the occurrence of the smoking or ignition caused by the abnormal load.

Recommended Wire Type:(For Single unit operation)

Do not apply more than 100-N force to the terminal block when tightening it.

Use the following material for the wires to be connected to the S8TS to prevent smoking or ignition caused by abnormal loads.

Recommended Wire Size for Single-unit Operation

Model	Recommended wire size
S8TS-02505	AWG 14 to 18 (cross-sectional area: 0.823 to 2.081 mm ²)
S8TS-03012 S8TS-06024	AWG 14 to 18 (cross-sectional area: 0.823 to 2.081 mm ²)
S8TS-02505F	AWG 12 to 18 (cross-sectional area: 0.823 to 3.309 mm ²)
S8TS-03012F S8TS-06024F	AWG 12 to 20 (cross-sectional area: 0.517 to 3.309 mm ²)

Recommended Wire Size for Parallel Operation

Model	Recommended wire size	
S8TS-03012 S8TS-06024	For 2 Units connected in parallel	AWG 14 to 18 (cross-sectional area: 0.823 to 2.081 mm ²)
	For 3 Units connected in parallel	AWG 14 to 16 (cross-sectional area: 1.309 to 2.081 mm ²)
	For 4 Units connected in parallel	AWG 14 (cross-sectional area: 2.081 mm ²)
S8TS-03012F S8TS-06024F	For 2 Units connected in parallel	AWG 12 to 18 (cross-sectional area: 0.823 to 3.309 mm ²)
	For 3 Units connected in parallel	AWG 12 to 16 (cross-sectional area: 1.309 to 3.309 mm ²)
	For 4 Units connected in parallel	AWG 12 to 14 (cross-sectional area: 2.081 to 3.309 mm ²)

Blocks with Connector Terminals

When using Blocks with connector terminals, the current for 1 terminal must not exceed 7.5 A. If a higher current is required, use 2 terminals.

Do not insert/remove AC input connectors or DC output connector more than 20 times.

Installation Environment

Do not use the Power Supply in locations subject to shocks or vibrations. In particular, install the Power Supply as far as possible from contactors or other devices that are a vibration source. Be sure to mount End Plates (PFP-M) on both ends of the Power Supply.

Install the Power Supply well away from any sources of strong, high-frequency noise and surge.

Ambient Operating and Storage Environments

Do not use or store the Power Supply in the following locations. Doing so may result in failure, malfunction, or deterioration of performance characteristics.

Do not use the Power Supply in locations subject to direct sunlight.

Do not use the Power Supply in locations where the ambient temperature exceeds the range of the derating curve.

Do not use the Power Supply in locations where the humidity is outside the range 25% to 85%, or locations subject to condensation due to sudden temperature changes.

Do not store the Power Supply in locations where the ambient temperature is outside the range -25 to 65°C or where the humidity is outside the range 25% to 95%.

Do not use the Power Supply in locations where liquids, foreign matter, corrosive gases, or corrosive gases may enter the interior of the Power Supply.

Short-circuits or overcurrent conditions that last for 20 seconds or longer may cause deterioration or damage to internal parts.

Output Voltage Adjuster (V.ADJ)

Do not exert excessive force on the output voltage adjuster (V.ADJ). Doing so may break the adjuster.

Setting the output voltage adjuster (V.ADJ) to 90% or less of the rated output voltage may cause the undervoltage detection function to operate.

Bus Line Connectors

Do not apply strong shocks (e.g., by dropping) to the Bus Line Connectors. Doing so may result in damage.

DIN Rail Mounting

To mount the Block on a DIN Rail, hook portion (A) of the Block onto the Rail and press the Block in direction (B).

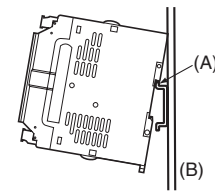

To dismount the Block, pull down portion (C) with a flat-blade screwdriver and pull out the Block.

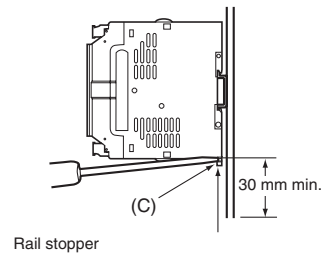

In Case There Is No Output Voltage

If there is no output voltage, it is possible that overload protection or overvoltage protection is operating. It is also possible that the latch protection circuit is operating due to the application of a large surge, such as lightning surge. Confirm the 2 points below. If there is still no output voltage, consult your OMRON representative.

- Checking for Overload Protection:
Separate the load line and confirm that it is not in an overload state (including short-circuits).
- Checking for Overvoltage Protection or Latch Protection:
Turn the input power OFF, and then turn it ON again after 1 minute or more has elapsed.

Buzzing Noise When the Input Is Turned ON

A harmonic current suppression circuit is built into the input power. This circuit can create noise when the input is turned ON, but it will last only until the internal operation stabilizes and does not indicate any problem in the Power Supply.

ALL DIMENSIONS SHOWN ARE IN MILLIMETERS.

To convert millimeters into inches, multiply by 0.03937. To convert grams into ounces, multiply by 0.03527.

In the interest of product improvement, specifications are subject to change without notice.

Read and Understand This Catalog

Please read and understand this catalog before purchasing the products. Please consult your OMRON representative if you have any questions or comments.

Warranty and Limitations of Liability

WARRANTY

OMRON's exclusive warranty is that the products are free from defects in materials and workmanship for a period of one year (or other period if specified) from date of sale by OMRON.

OMRON MAKES NO WARRANTY OR REPRESENTATION, EXPRESS OR IMPLIED, REGARDING NON-INFRINGEMENT, MERCHANTABILITY, OR FITNESS FOR PARTICULAR PURPOSE OF THE PRODUCTS. ANY BUYER OR USER ACKNOWLEDGES THAT THE BUYER OR USER ALONE HAS DETERMINED THAT THE PRODUCTS WILL SUITABLY MEET THE REQUIREMENTS OF THEIR INTENDED USE. OMRON DISCLAIMS ALL OTHER WARRANTIES, EXPRESS OR IMPLIED.

LIMITATIONS OF LIABILITY

OMRON SHALL NOT BE RESPONSIBLE FOR SPECIAL, INDIRECT, OR CONSEQUENTIAL DAMAGES, LOSS OF PROFITS OR COMMERCIAL LOSS IN ANY WAY CONNECTED WITH THE PRODUCTS, WHETHER SUCH CLAIM IS BASED ON CONTRACT, WARRANTY, NEGLIGENCE, OR STRICT LIABILITY.

In no event shall the responsibility of OMRON for any act exceed the individual price of the product on which liability is asserted.

IN NO EVENT SHALL OMRON BE RESPONSIBLE FOR WARRANTY, REPAIR, OR OTHER CLAIMS REGARDING THE PRODUCTS UNLESS OMRON'S ANALYSIS CONFIRMS THAT THE PRODUCTS WERE PROPERLY HANDLED, STORED, INSTALLED, AND MAINTAINED AND NOT SUBJECT TO CONTAMINATION, ABUSE, MISUSE, OR INAPPROPRIATE MODIFICATION OR REPAIR.

Application Considerations

SUITABILITY FOR USE

OMRON shall not be responsible for conformity with any standards, codes, or regulations that apply to the combination of products in the customer's application or use of the products.

At the customer's request, OMRON will provide applicable third party certification documents identifying ratings and limitations of use that apply to the products. This information by itself is not sufficient for a complete determination of the suitability of the products in combination with the end product, machine, system, or other application or use.

The following are some examples of applications for which particular attention must be given. This is not intended to be an exhaustive list of all possible uses of the products, nor is it intended to imply that the uses listed may be suitable for the products:

- Outdoor use, uses involving potential chemical contamination or electrical interference, or conditions or uses not described in this catalog.
- Nuclear energy control systems, combustion systems, railroad systems, aviation systems, medical equipment, amusement machines, vehicles, safety equipment, and installations subject to separate industry or government regulations.
- Systems, machines, and equipment that could present a risk to life or property.

Please know and observe all prohibitions of use applicable to the products.

NEVER USE THE PRODUCTS FOR AN APPLICATION INVOLVING SERIOUS RISK TO LIFE OR PROPERTY WITHOUT ENSURING THAT THE SYSTEM AS A WHOLE HAS BEEN DESIGNED TO ADDRESS THE RISKS, AND THAT THE OMRON PRODUCTS ARE PROPERLY RATED AND INSTALLED FOR THE INTENDED USE WITHIN THE OVERALL EQUIPMENT OR SYSTEM.

PROGRAMMABLE PRODUCTS

OMRON shall not be responsible for the user's programming of a programmable product, or any consequence thereof.

Disclaimers

CHANGE IN SPECIFICATIONS

Product specifications and accessories may be changed at any time based on improvements and other reasons.

It is our practice to change model numbers when published ratings or features are changed, or when significant construction changes are made. However, some specifications of the products may be changed without any notice. When in doubt, special model numbers may be assigned to fix or establish key specifications for your application on your request. Please consult with your OMRON representative at any time to confirm actual specifications of purchased products.

DIMENSIONS AND WEIGHTS

Dimensions and weights are nominal and are not to be used for manufacturing purposes, even when tolerances are shown.

PERFORMANCE DATA

Performance data given in this catalog is provided as a guide for the user in determining suitability and does not constitute a warranty. It may represent the result of OMRON's test conditions, and the users must correlate it to actual application requirements. Actual performance is subject to the OMRON Warranty and Limitations of Liability.

ERRORS AND OMISSIONS

The information in this document has been carefully checked and is believed to be accurate; however, no responsibility is assumed for clerical, typographical, or proofreading errors, or omissions.

2011.6

In the interest of product improvement, specifications are subject to change without notice.

OMRON Corporation
Industrial Automation Company

<http://www.ia.omron.com/>

(c)Copyright OMRON Corporation 2011 All Right Reserved.

Mouser Electronics

Authorized Distributor

Click to View Pricing, Inventory, Delivery & Lifecycle Information:

Omron:

[S8TS-03012F-E1](#) [S8T-BUS02](#) [S8TS-02505F](#) [S8TS-06024-E1.](#) [S8TS-06024-E1](#)

Mouser Electronics

Authorized Distributor

Click to View Pricing, Inventory, Delivery & Lifecycle Information:

Omron:

[S8T-BUS02](#) [S8T-BUS03](#)



Стандарт Электрон Связь

Мы молодая и активно развивающаяся компания в области поставок электронных компонентов. Мы поставляем электронные компоненты отечественного и импортного производства напрямую от производителей и с крупнейших складов мира.

Благодаря сотрудничеству с мировыми поставщиками мы осуществляем комплексные и плановые поставки широчайшего спектра электронных компонентов.

Собственная эффективная логистика и склад в обеспечивает надежную поставку продукции в точно указанные сроки по всей России.

Мы осуществляем техническую поддержку нашим клиентам и предпродажную проверку качества продукции. На все поставляемые продукты мы предоставляем гарантию .

Осуществляем поставки продукции под контролем ВП МО РФ на предприятия военно-промышленного комплекса России , а также работаем в рамках 275 ФЗ с открытием отдельных счетов в уполномоченном банке. Система менеджмента качества компании соответствует требованиям ГОСТ ISO 9001.

Минимальные сроки поставки, гибкие цены, неограниченный ассортимент и индивидуальный подход к клиентам являются основой для выстраивания долгосрочного и эффективного сотрудничества с предприятиями радиоэлектронной промышленности, предприятиями ВПК и научно-исследовательскими институтами России.

С нами вы становитесь еще успешнее!

Наши контакты:

Телефон: +7 812 627 14 35

Электронная почта: sales@st-electron.ru

Адрес: 198099, Санкт-Петербург,
Промышленная ул, дом № 19, литера Н,
помещение 100-Н Офис 331