

LTC4126EDC Low Power Wireless Charger Demonstration Kit

DESCRIPTION

DC2663A-KIT is a Demonstration kit of the DC2662A receiver board, featuring the LTC4126EDC, the DC2661A single-switch transmitter board featuring the LTC6992 and the DC2687A application-sized receiver board featuring the

LTC4126EDC. The DC2662A can charge a single Li-Ion battery at up to 7.5 mA with an air gap of 2.0 mm to 4.0 mm.

[Design files for this circuit board are available.](#)

All registered trademarks and trademarks are the property of their respective owners.

CONTENTS

- 1 × DC2662A (LTC4126EDC) Receiver Demo Board
- 1 × DC2661A (LTC6992) Transmitter Demo Board
- 2 × DC2687A (LTC4126EDC) Application-Sized Receiver Demo Board

PERFORMANCE SUMMARY

Specifications are at $T_A = 25^\circ\text{C}$

SYMBOL	PARAMETER	CONDITIONS	MIN	TYP	MAX	UNITS
V_{IN}	DC2661A Voltage Input	$I_{VIN} \leq 0.5\text{A}$	4.5		5.5	V
I_{BAT}	DC2662A battery charger current	$V_{IN} = 4.5\text{V} - 5.5\text{V}$, DC2661A.R4 = 232 Ω ; $V_{BAT} = 2.7\text{V}$ to $V_{charge-50\text{mV}}$		7.5		mA
V_{BAT}	Charge Voltage	$V_{SEL} = \text{GND}$		4.2		V
		$V_{SEL} = V_{BAT}$		4.35		V
V_{OUT}	DC/DC Regulator Output Voltage	$V_{BAT} > 3.6\text{V}$		1.2		V

BOARD PHOTO

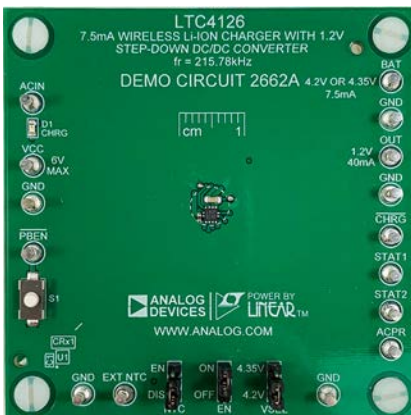

Figure 1. DC2662A Picture

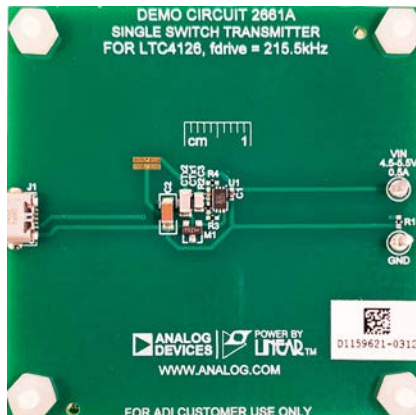

Figure 2. DC2661A Picture



Figure 3. DC2687A Picture

QUICK START PROCEDURE

Refer to Figure 5 and Figure 6 for the proper measurement equipment setup, DC2662A mounting on DC2661A, and follow the procedure below:

NOTE. When measuring the input or output voltage ripple, care must be taken to avoid a long ground lead on the oscilloscope probe. Measure the input or output voltage ripple by touching the probe tip directly across the signal and GND terminals. Figure 11 for proper scope probe technique.

1. Plug a Micro-USB cable into DC2661A.J1, with the other end of the cable connected to a computer USB port or a 5V wall wart. The demo may also be powered by applying 4.5-5.5V between V_{IN} terminal DC2661A.E1 and GND terminal DC2661A.E2 (Figure 6).
2. Connect a voltage source PS1 and a 200 Ohm resistor RBAT1 between the BAT and GND terminals DC2662A.E8 and DC2662A.E14, respectively (Figure 5). PS1 and RBAT1 make up the battery emulator. Typical power supplies cannot sink current. By adding a resistor across the power supply inputs that draws more current than the maximum battery charging current, the power supply only sources current even when the battery charge current is at its maximum value.
3. Set PS1 equal to 3.9 Volts. If using PS2 instead of Micro-USB set PS2 equal to 5.0 Volts and turn on PS1 and PS2.

4. The LTC4126EDC starts by outputting a current dependent on the voltage measured at the BAT terminal. DC2662A.D1 should be blinking slowly. Ammeter AM1 should read between 0-7.5mA depending on the voltage of the battery. For all battery voltages above 3.6 volts and 154mV below the charge voltage, the charge current should be between 7.00mA and 8.00mA.
5. If EN is in the ON position, voltage measured at OUT terminal should be around 1.2V. If EN is in the OFF position, the voltage on the OUT terminal will be controlled by pushbutton DC2662A.S1.
6. To test the DC2687A-1 application-sized PCB, first repeat step 1. Next, slide the PCB(s) (while still in the bag) LED side up in between DC2662A and DC2661A until they are over the lower coil. The LEDs on top should start to blink slowly. If it is difficult to see, separate DC2662A and DC2661A and repeat this step (Figure 10).

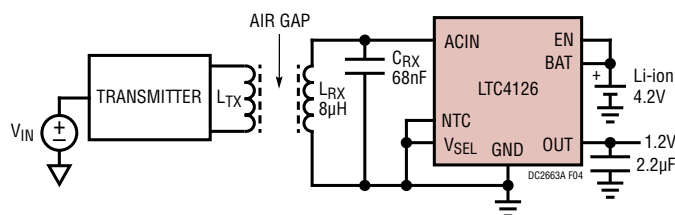

Figure 4. Minimum Component Count Application Circuit

QUICK START PROCEDURE

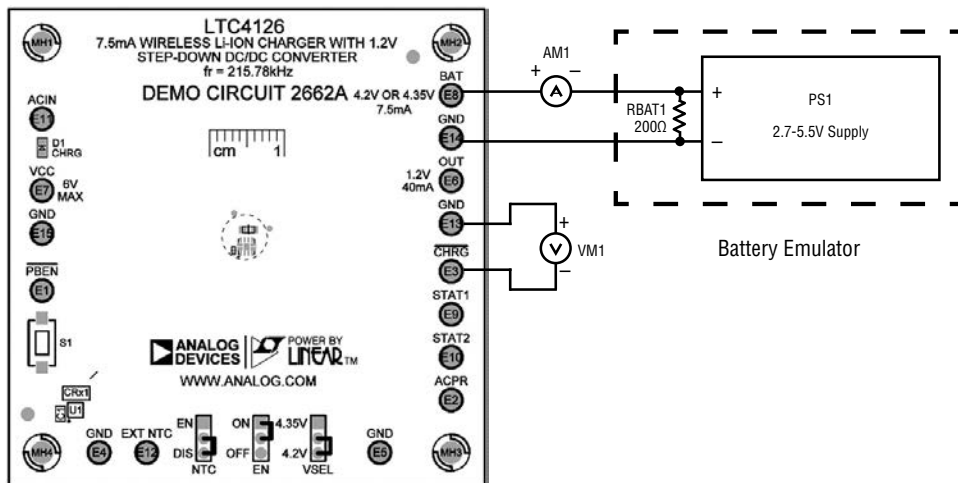

Figure 5. DC2662A Top

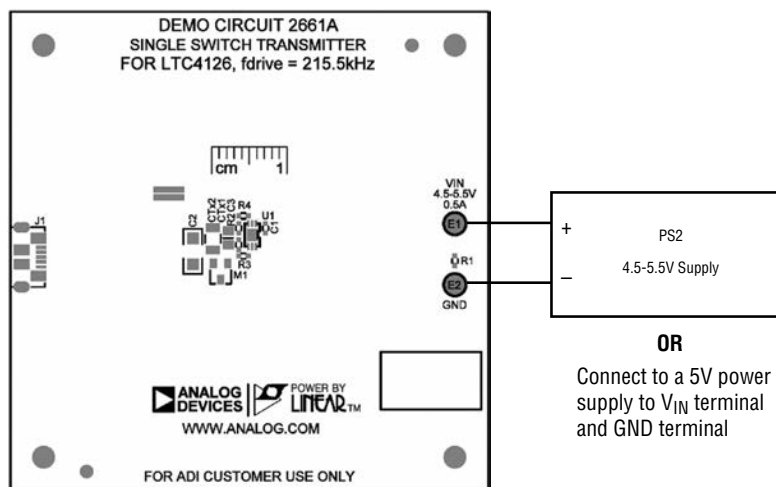

Figure 6. DC2661A Top

Power DC2661 using USB Micro-B to host or a 5V wall adapter.



Figure 7. DC2662A mounted on top of DC2661A

NOTE: All connections from voltage measurement equipment should be Kelvin connected directly to the board pins and any input or output leads should be twisted pair.

DEMO MANUAL DC2663A-KIT

QUICK START PROCEDURE

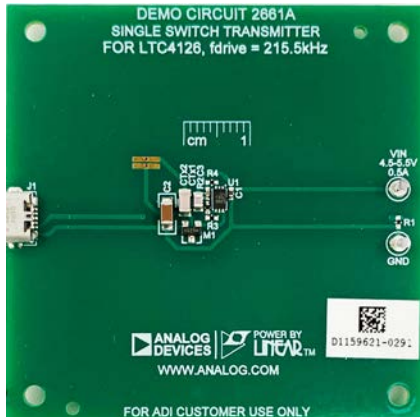

Figure 8. DC2661A Top/Bottom

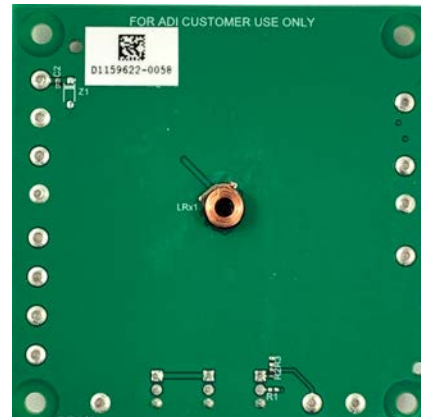
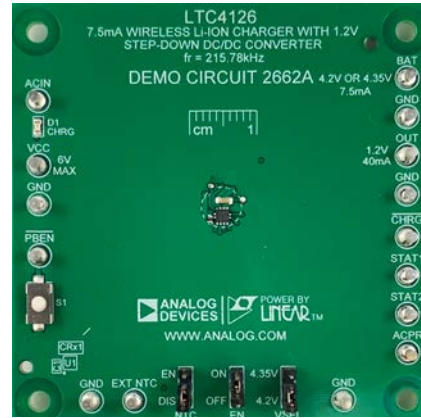

Figure 9. DC2662A Top/Bottom

QUICK START PROCEDURE



Figure 10. DC2687A (2 in bag) on DC2261A coil



Figure 11. Measuring input or Output Ripple

DEMO MANUAL DC2663A-KIT

OPERATION

The DC2663A-KIT demonstrates operation of the LTC4126EDC Wireless Low Power Battery Charger. The kit is composed of a DC2661A Wireless Power Transfer (WPT) transmitter board, a DC2662A receiver board and two DC2867A 5.2mm diameter application-sized receiver boards.

DC2662A – Low Power Battery Charger Board featuring the LTC4126EDC

The LTC4126EDC integrates a low power CC-CV linear charger optimized for Li-Ion cells. The LTC4126EDC also contains a low leakage SCHOTTKY diode for rectifying the output of the WPT resonant tank. The DC2661A WPT resonant tank is set to 216 kHz. The CC-CV charger will operate with a V_{CC} as low as 4.5V and charge a Li-Ion battery to 4.2V ($T_A = 25^\circ\text{C}$, $V_{SEL} = \text{GND}$).

The WPT for the LTC4126EDC is implemented as resonant power transfer, with the LTC4126EDC rectifying the resonant tank voltage to generate V_{CC} . The LTC4126EDC keeps the voltage at V_{CC} always within 5-5.5V when regulating received power from the WPT transmitter. When the V_{CC} voltage reaches a maximum of 5.5V, an input shunt is activated that diverts the received power. When the voltage at V_{CC} drops to 5 Volts, the shunt is deactivated, and the power is delivered and rectified through ACIN again until V_{CC} rises to 5.5V (see Figure 5).

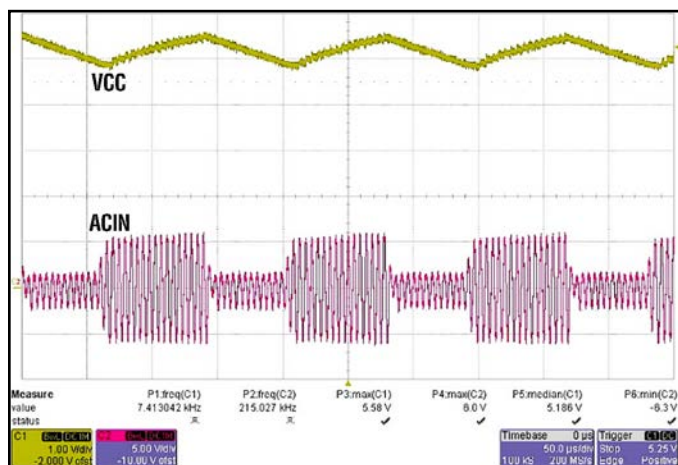

Figure 12. DC2662A: Red = ACIN, Gold = V_{CC} , $V_{IN}(\text{DC2661A}) = 5\text{V}$, air gap = 4mm

DC2661A – Wireless Power Transmitter Board featuring the LTC6992DCB

The DC2661A is a wireless power transmitter board using an LTC6992DCB oscillator, followed by a zero-voltage switching (ZVS) Class C amplifier.

The LTC6992DCB is programmed to generate a 216 kHz square wave, but the Class C amplifier tank is resonant at 266 kHz, resulting in zero voltage switching. The peak voltage of the transmit coil, LTx1, that appears at the drain of M1 is:

$$V_{TX-PEAK} = 1.038 \cdot \pi \cdot V_{IN} = 16.30\text{V}$$

This value, as well as ZVS can be seen in Figure 13.

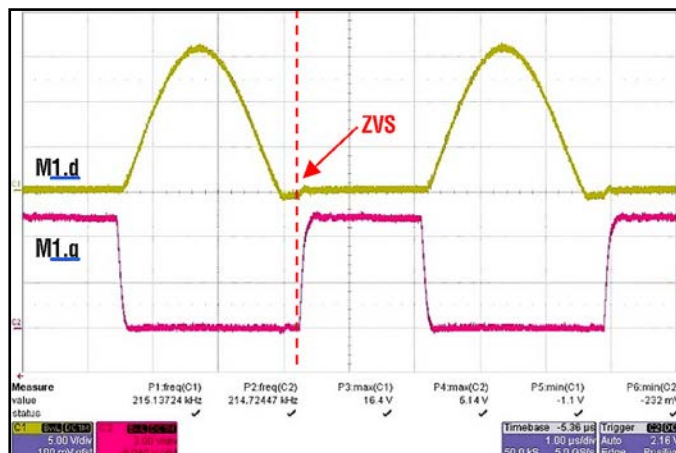

Figure 13. DC2661A: Red = M1.g, Gold = M1.d, $V_{IN}(\text{DC2661A}) = 5\text{V}$, air gap = 4mm

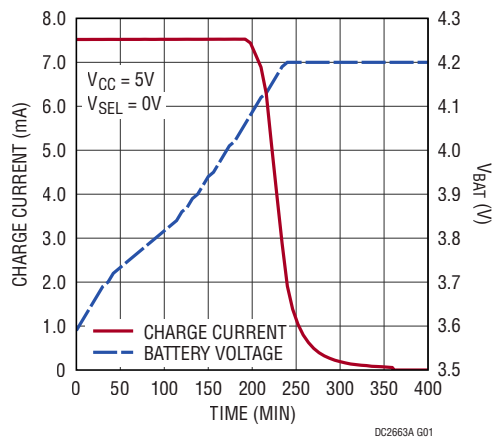

Figure 14. Battery Charging Profile with DC2662A Mounted on top of DC2661A

DEMO MANUAL DC2663A-KIT

PARTS LIST

ITEM	QTY	REFERENCE	PART DESCRIPTION	MANUFACTURER/PART NUMBER
DC2661A Required Circuit Components				
1	1	C1	CAP, 4.7uF, X5R, 10V, 10%, 0402	TDK, C1005X5R1A475K050BC
2	1	C2	CAP, 100uF, X5R, 10V, 20%, 1206	TDK, C3216X5R1A107M160AC
3	1	C3	CAP, 0.1uF, X5R, 10V, 10%, 0402	AVX, 0402ZD104KAT2A
4	1	CTx1	CAP, 0.033uF, C0G, 50V, 5%, 0805	TDK, C2012C0G1H333J125AA
5	1	CTx2	CAP, 0.1uF, C0G, 50V, 5%, 1206	TDK, C3216C0G1H104J160AA
6	1	LTX1	IND., 2.7UH, WIRELESS CHR. COIL TX, +/-10%, 0.05OHM, ROUND, 20MMX20MM, CUSTOMIZED	SUNLORD, MQQTC202030S2R7
7	1	M1	XSTR, MOSFET, N-CH, 20V, 6A, SOT23-3	VISHAY, SI2312CDS-T1-GE3
8	1	R2	RES, 732K OHMS, 1%, 1/16W, 0402, AEC-Q200	VISHAY, CRCW0402732KFKED
9	1	R3	RES., 66.5K OHMS, 1%, 1/16W, 0402, AEC-Q200	VISHAY, CRCW040266K5FKED
10	1	R4	RES., 232K OHMS, 1%, 1/16W, 0402, AEC-Q200	VISHAY, CRCW0402232KFKED
11	1	U1	OSCILLATOR, TIMERBLOX, VC PWM, 3.81HZ TO 1MHZ, 90PPM, DFN-6, CMOS	ANALOG DEVICES, LTC6992IDCB-1#PBF
Additional Demo Board Circuit Components				
1	1	D1	LED, RED, WATER-CLEAR, 0603	LITE-ON, LTST-C193KRKT-5A
2	1	R1	RES., 2.2K OHMS, 5%, 1/16W, 0402	VISHAY, CRCW04022K20JNED
Hardware: For Demo Board Only				
1	2	E1, E2	TEST POINT, TURRET, 0.064", MTG. HOLE	MILL-MAX, 2308-2-00-80-00-00-07-0
2	1	J1	CONN, UUSB 2.0, RCPT, 5 PINS, 1 PORT, REVERSE MOUNT, R/A HORZ, TYPE B, FLANGELESS	TE CONNECTIVITY, 1932788-1
DC2662A Required Circuit Components				
1	1	C1	CAP, 2.2UF, X5R, 16V, 20%, 0402	TDK, C1005X5R1C225M050BC
2	1	C2	CAP, 1UF, X5R, 16V, 10%, 0402	AVX, 0402YD105KAT2A
3	1	CRX1	CAP, 0.068UF, X7R, 16V, 5%, 0603	AVX, 0603YC683JAT2A
4	1	LRX1	IND, 8UH, WIRELESS CHR. COIL TX, +/-10%, ROUND, 6MMX6MM, CUSTOMIZED	SUNLORD, MQQRC060630S8R0
5	1	R2	RES., 0 OHM, 5%, 1/16W, 0402	ROHM, MCR01MZPJ000
6	1	U1	IC, 7.5MA WIRELESS LI-ION CHARGER WITH 1.2V STEP-DOWN DC/DC CONVERTER, LQFN-12	ANALOG DEVICES, LTC4126EV#PBF
Additional Demo Board Circuit Components				
1	1	D1	LED, RED, WATER-CLEAR, 0603	LITE-ON, LTST-C193KRKT-5A
Hardware: For Demo Board Only				
1	15	E1-E15	TEST POINT, TURRET, 0.064", MTG. HOLE	MILL-MAX, 2308-2-00-80-00-00-07-0
2	3	JP1-JP3	CONN, HDR, MALE, 1X3, 2MM, VERT, STR, THT	WURTH ELEKTRONIK, 62000311121
3	1	S1	SWITCH, TACT, SPST-NO, 0.05A, 12VDC, SMD, 6 X 3.8 X 2.5MM, WHITE	WURTH ELEKTRONIK, 434111025826
4	3	XJP1-XJP3	CONN, SHUNT, FEMALE, 2 POS, 2MM	WURTH ELEKTRONIK, 60800213421

DEMO MANUAL DC2663A-KIT

PARTS LIST

ITEM	QTY	REFERENCE	PART DESCRIPTION	MANUFACTURER/PART NUMBER
DC2687A Required Circuit Components				
1	1	COU1	CAP, 2.2UF, X5R, 16V, 20%, 0402	TDK, C1005X5R1C225M050BC
2	1	CRX1	CAP, 0.068UF, X7R, 16V, 5%, 0603	AVX, 0603YC683JAT2A
3	1	LRX1	IND., 7.2UH, WIRELESS CHR. COIL RX, +/-10%, 500MA, 440MOHMS, 6MMX2MM, 1 COIL, 1 LAYER	WURTH ELEKTRONIK, 760308101216
4	1	U1	IC, 7.5MA WIRELESS LI-ION CHARGER WITH 1.2V STEP-DOWN DC/DC CONVERTER, LQFN-12	ANALOG DEVICES, LTC4126EV#PBF
Additional Demo Board Circuit Components				
1	1	D1	LED, RED, CLEAR, 0402, SMD	ROHM, SML-P11UTT86
2	1	Z1	DIODE, ZENER, 3.3V, 100MW, 0201	COMCHIP, CZRZ3V3B-HF

SCHEMATIC DIAGRAM

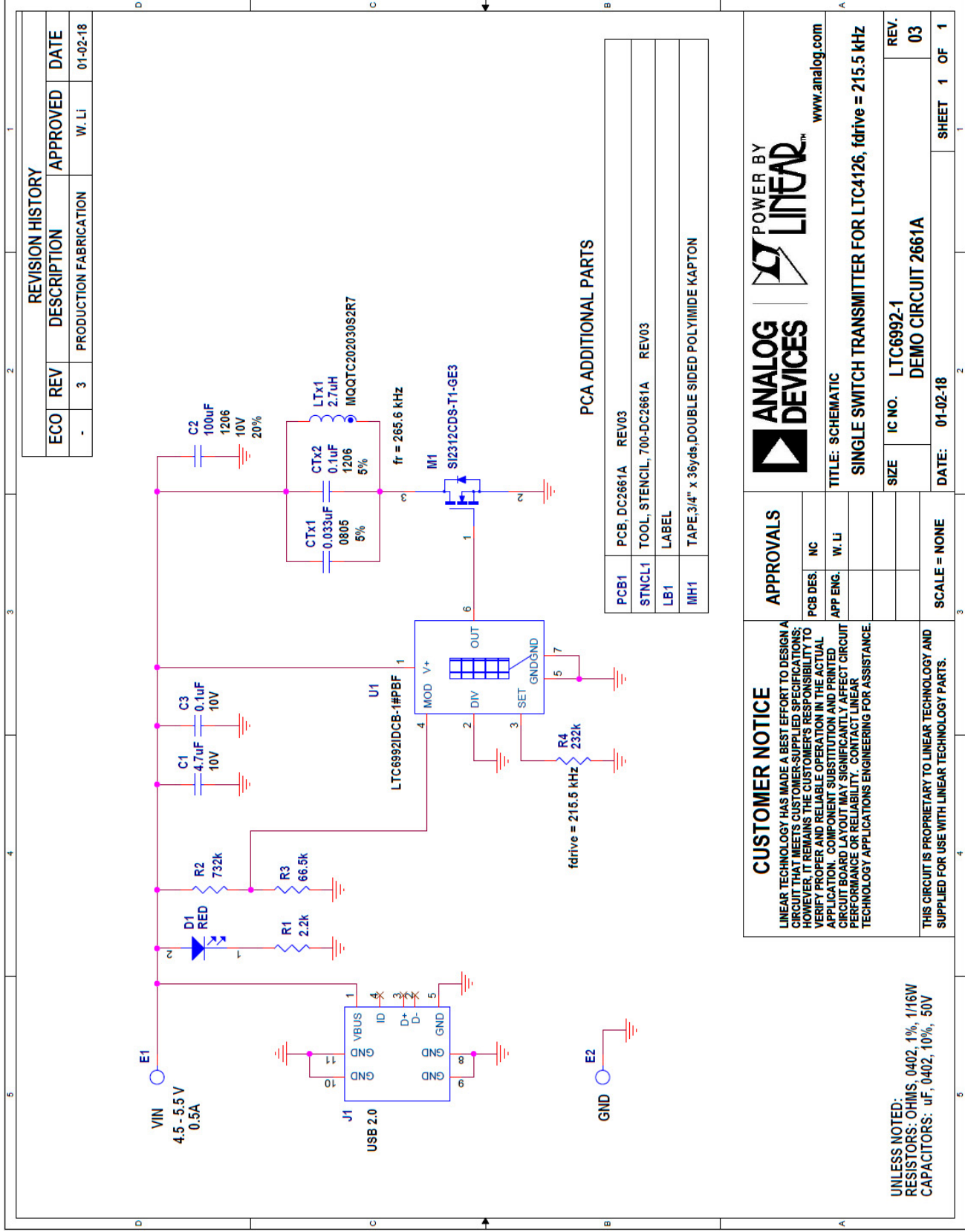

DEMO MANUAL DC2663A-KIT

SCHEMATIC DIAGRAM

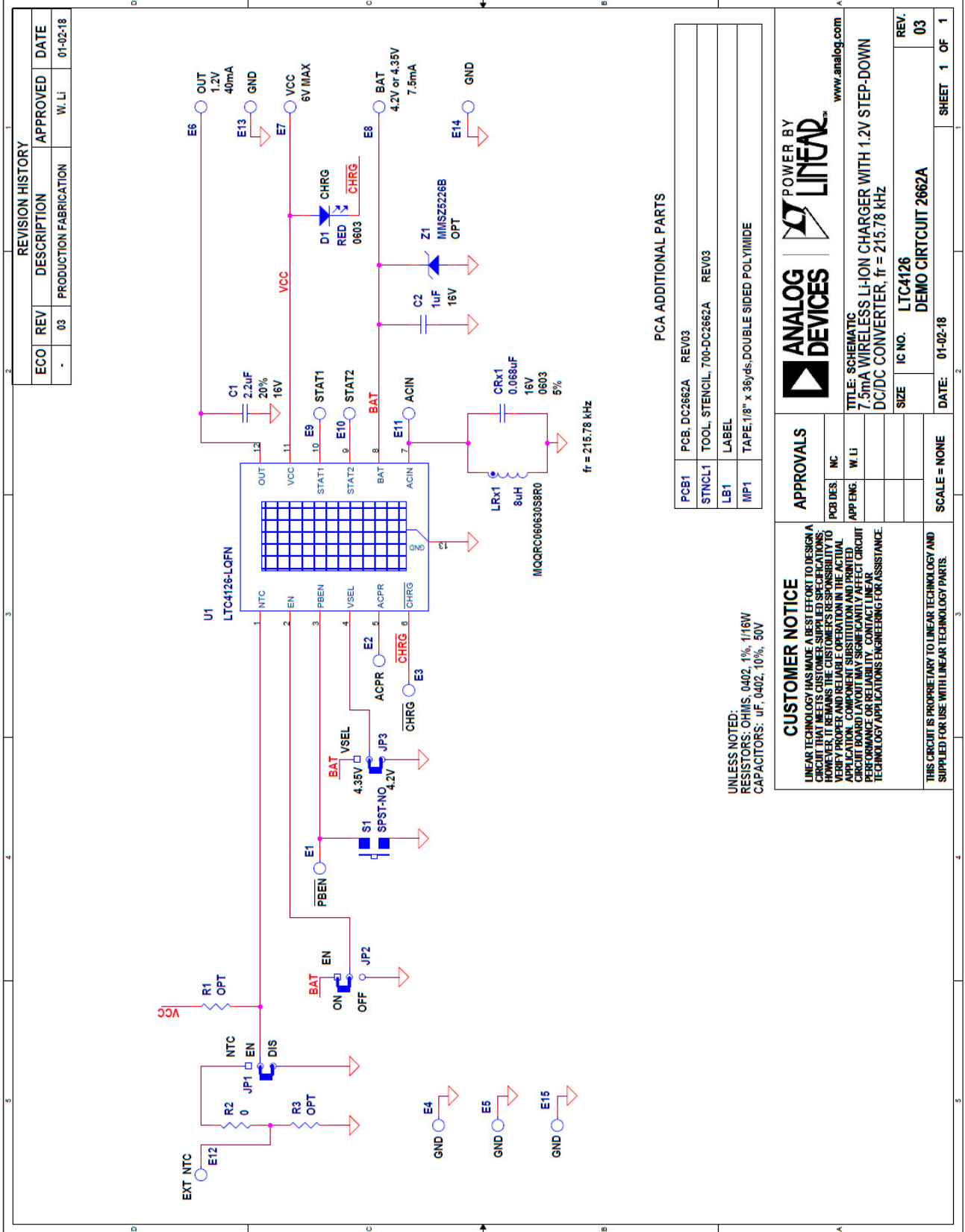

SCHEMATIC DIAGRAM

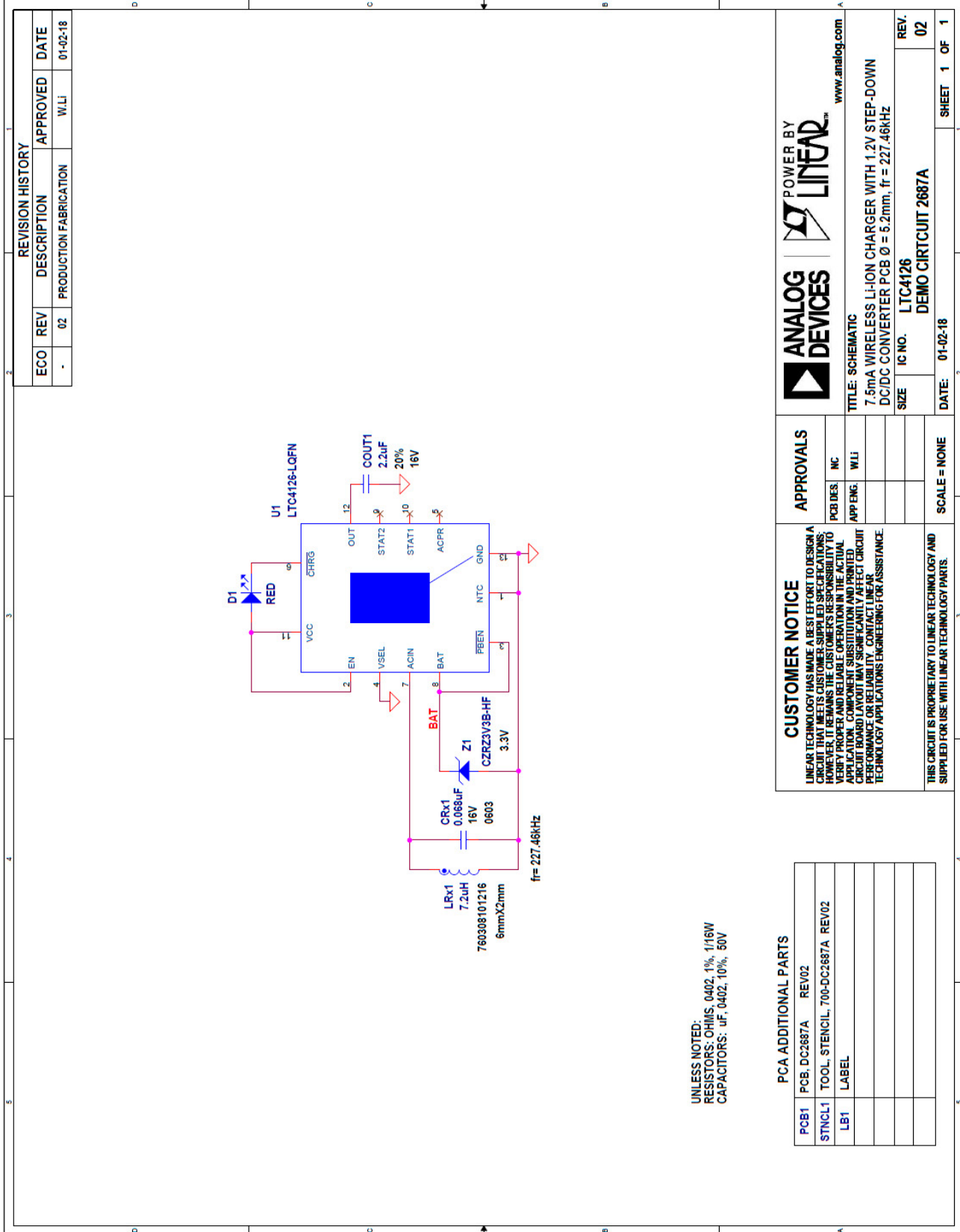



ESD Caution

ESD (electrostatic discharge) sensitive device. Charged devices and circuit boards can discharge without detection. Although this product features patented or proprietary protection circuitry, damage may occur on devices subjected to high energy ESD. Therefore, proper ESD precautions should be taken to avoid performance degradation or loss of functionality.

Legal Terms and Conditions

By using the evaluation board discussed herein (together with any tools, components documentation or support materials, the "Evaluation Board"), you are agreeing to be bound by the terms and conditions set forth below ("Agreement") unless you have purchased the Evaluation Board, in which case the Analog Devices Standard Terms and Conditions of Sale shall govern. Do not use the Evaluation Board until you have read and agreed to the Agreement. Your use of the Evaluation Board shall signify your acceptance of the Agreement. This Agreement is made by and between you ("Customer") and Analog Devices, Inc. ("ADI"), with its principal place of business at One Technology Way, Norwood, MA 02062, USA. Subject to the terms and conditions of the Agreement, ADI hereby grants to Customer a free, limited, personal, temporary, non-exclusive, non-sublicensable, non-transferable license to use the Evaluation Board FOR EVALUATION PURPOSES ONLY. Customer understands and agrees that the Evaluation Board is provided for the sole and exclusive purpose referenced above, and agrees not to use the Evaluation Board for any other purpose. Furthermore, the license granted is expressly made subject to the following additional limitations: Customer shall not (i) rent, lease, display, sell, transfer, assign, sublicense, or distribute the Evaluation Board; and (ii) permit any Third Party to access the Evaluation Board. As used herein, the term "Third Party" includes any entity other than ADI, Customer, their employees, affiliates and in-house consultants. The Evaluation Board is NOT sold to Customer; all rights not expressly granted herein, including ownership of the Evaluation Board, are reserved by ADI. CONFIDENTIALITY. This Agreement and the Evaluation Board shall all be considered the confidential and proprietary information of ADI. Customer may not disclose or transfer any portion of the Evaluation Board to any other party for any reason. Upon discontinuation of use of the Evaluation Board or termination of this Agreement, Customer agrees to promptly return the Evaluation Board to ADI. ADDITIONAL RESTRICTIONS. Customer may not disassemble, decompile or reverse engineer chips on the Evaluation Board. Customer shall inform ADI of any occurred damages or any modifications or alterations it makes to the Evaluation Board, including but not limited to soldering or any other activity that affects the material content of the Evaluation Board. Modifications to the Evaluation Board must comply with applicable law, including but not limited to the RoHS Directive. TERMINATION. ADI may terminate this Agreement at any time upon giving written notice to Customer. Customer agrees to return to ADI the Evaluation Board at that time. LIMITATION OF LIABILITY. THE EVALUATION BOARD PROVIDED HEREUNDER IS PROVIDED "AS IS" AND ADI MAKES NO WARRANTIES OR REPRESENTATIONS OF ANY KIND WITH RESPECT TO IT. ADI SPECIFICALLY DISCLAIMS ANY REPRESENTATIONS, ENDORSEMENTS, GUARANTEES, OR WARRANTIES, EXPRESS OR IMPLIED, RELATED TO THE EVALUATION BOARD INCLUDING, BUT NOT LIMITED TO, THE IMPLIED WARRANTY OF MERCHANTABILITY, TITLE, FITNESS FOR A PARTICULAR PURPOSE OR NON-INFRINGEMENT OF INTELLECTUAL PROPERTY RIGHTS. IN NO EVENT WILL ADI AND ITS LICENSORS BE LIABLE FOR ANY INCIDENTAL, SPECIAL, INDIRECT, OR CONSEQUENTIAL DAMAGES RESULTING FROM CUSTOMER'S POSSESSION OR USE OF THE EVALUATION BOARD, INCLUDING BUT NOT LIMITED TO LOST PROFITS, DELAY COSTS, LABOR COSTS OR LOSS OF GOODWILL. ADI'S TOTAL LIABILITY FROM ANY AND ALL CAUSES SHALL BE LIMITED TO THE AMOUNT OF ONE HUNDRED US DOLLARS (\$100.00). EXPORT. Customer agrees that it will not directly or indirectly export the Evaluation Board to another country, and that it will comply with all applicable United States federal laws and regulations relating to exports. GOVERNING LAW. This Agreement shall be governed by and construed in accordance with the substantive laws of the Commonwealth of Massachusetts (excluding conflict of law rules). Any legal action regarding this Agreement will be heard in the state or federal courts having jurisdiction in Suffolk County, Massachusetts, and Customer hereby submits to the personal jurisdiction and venue of such courts. The United Nations Convention on Contracts for the International Sale of Goods shall not apply to this Agreement and is expressly disclaimed.



Стандарт Электрон Связь

Мы молодая и активно развивающаяся компания в области поставок электронных компонентов. Мы поставляем электронные компоненты отечественного и импортного производства напрямую от производителей и с крупнейших складов мира.

Благодаря сотрудничеству с мировыми поставщиками мы осуществляем комплексные и плановые поставки широчайшего спектра электронных компонентов.

Собственная эффективная логистика и склад в обеспечивает надежную поставку продукции в точно указанные сроки по всей России.

Мы осуществляем техническую поддержку нашим клиентам и предпродажную проверку качества продукции. На все поставляемые продукты мы предоставляем гарантию .

Осуществляем поставки продукции под контролем ВП МО РФ на предприятия военно-промышленного комплекса России , а также работаем в рамках 275 ФЗ с открытием отдельных счетов в уполномоченном банке. Система менеджмента качества компании соответствует требованиям ГОСТ ISO 9001.

Минимальные сроки поставки, гибкие цены, неограниченный ассортимент и индивидуальный подход к клиентам являются основой для выстраивания долгосрочного и эффективного сотрудничества с предприятиями радиоэлектронной промышленности, предприятиями ВПК и научно-исследовательскими институтами России.

С нами вы становитесь еще успешнее!

Наши контакты:

Телефон: +7 812 627 14 35

Электронная почта: sales@st-electron.ru

Адрес: 198099, Санкт-Петербург,
Промышленная ул, дом № 19, литера Н,
помещение 100-Н Офис 331