

# MAXIM

## Octal, 8-Bit, Serial DACs with Output Buffer

**MAX528/MAX529**

### General Description

The MAX528/MAX529 are monolithic devices combining an octal 8-bit, digital-to-analog converter (DAC), 8 output buffers, and serial-interface logic in a space-saving shrink small outline package (SSOP). The MAX528 operates from a single supply up to 15V or from split supplies totaling up to 20V, including +5V/-15V, +12V/-5V, and +15V/-5V. The MAX529 operates from a single +5V supply or from  $\pm 5V$  split supplies. For both parts, a shutdown pin reduces current consumption to under 50 $\mu A$ , while retaining all internal DAC data.

Three output modes are serially programmable for each pair of 8 analog outputs. An unbuffered mode connects the internal R-2R DAC network directly to the output pin, reducing power consumption and avoiding the buffer's DC errors. A full-buffered mode inserts a buffer between the R-2R network and the output, providing +5mA/-2mA output drive. Half-buffered output mode is similar, but uses less power while still providing up to 15mA of output drive in a unipolar output configuration.

Serial data can be "daisy-chained" from one device to another. On power-up, all data bits are reset to 0, and analog outputs enter the unbuffered mode.

### Applications

- Digital Gain and Offset Adjustment
- Digital Calibration
- Multiple Trim Pot Replacement
- Microcontrolled Analog Outputs

### Features

- ◆ Now Available in Space-Saving SSOP
- ◆ 8 Buffered Noninverting Outputs
- ◆ Buffer Disable Control
- ◆ 2 Pairs of Differential Reference Inputs
- ◆ 3-Wire Serial Interface
- ◆ Single +5V or Dual  $\pm 5V$  Supply Operation (MAX529)
- ◆ Low-Power Shutdown
- ◆ Stable Driving Output Capacitance Loads

### Ordering Information

| PART      | TEMP. RANGE     | PIN-PACKAGE    |
|-----------|-----------------|----------------|
| MAX528CPP | 0°C to +70°C    | 20 Plastic DIP |
| MAX528CWG | 0°C to +70°C    | 24 Wide SO     |
| MAX528CAG | 0°C to +70°C    | 24 SSOP        |
| MAX528C/D | 0°C to +70°C    | Dice*          |
| MAX528EPP | -40°C to +85°C  | 20 Plastic DIP |
| MAX528EWG | -40°C to +85°C  | 24 Wide SO     |
| MAX528EAG | -40°C to +85°C  | 24 SSOP        |
| MAX528MJP | -55°C to +125°C | 20 CERDIP**    |

Ordering Information continued on last page.

\* Contact factory for dice specifications.

\*\* Contact factory for availability and processing to MIL-STD-883.

### Pin Configurations



**MAXIM**

Maxim Integrated Products 1

Call toll free 1-800-998-8800 for free samples or literature.

# Octal 8-Bit Serial DACs with Output Buffer

## ABSOLUTE MAXIMUM RATINGS - MAX528

|   |  |
|---|--|
| V <sub>DD</sub> to GND                            | -0.3V to +17V                                      |
| V <sub>DD</sub> to V <sub>SS</sub>                | -0.3V to +22V                                      |
| V <sub>SS</sub> to GND                            | -17V to +0.3V                                      |
| REFH1 - REFL1, REFH2 - REFL2                      | -0.3V to +12V                                      |
| REFH1 - V <sub>SS</sub> , REFH2 - V <sub>SS</sub> | +17V   |
| REFH1, REFH2                                      | REFL <sub>-</sub> - 0.3V to V <sub>DD</sub> + 0.3V |
| REFL1, REFL2                                      | V <sub>SS</sub> - 0.3V to REFH <sub>-</sub> + 0.3V |
| OUT(1-8)  | V <sub>SS</sub> - 0.3V to V <sub>DD</sub> + 0.3V   |
| OUT(1-8) to V <sub>SS</sub>                       | +17V   |
| OUT(1-8) Current                                  | ±20mA  |
| DIN, CLK, CS, DOUT                                | -0.3V to V <sub>DD</sub> + 0.3V                    |
| SHDN  | V <sub>SS</sub> - 0.3V to V <sub>DD</sub> + 0.3V   |

|   |                 |
|---|-----------------|
| DOUT Current  | ±20mA           |
| Continuous Power Dissipation (T <sub>A</sub> = +70°C) |                 |
| Plastic DIP (derate 11.11mW/°C above +70°C)           | 889mW           |
| Wide SO (derate 11.76mW/°C above +70°C)               | 941mW           |
| SSOP (derate 8.00mW/°C above +70°C)                   | 640mW           |
| CERDIP (derate 11.11mW/°C above +70°C)                | 889mW           |
| Operating Temperature Ranges:                         |                 |
| MAX528C <sub>-</sub>                                  | 0°C to +70°C    |
| MAX528E <sub>-</sub>                                  | -40°C to +85°C  |
| MAX528MJP   | -55°C to +125°C |
| Storage Temperature Range                             | -65°C to +160°C |
| Lead Temperature (soldering, 10 sec)                  | +300°C          |

Stresses beyond those listed under "Absolute Maximum Ratings" may cause permanent damage to the device. These are stress ratings only, and functional operation of the device at these or any other conditions beyond those indicated in the operational sections of the specifications is not implied. Exposure to absolute maximum rating conditions for extended periods may affect device reliability.

## ELECTRICAL CHARACTERISTICS - MAX528

(Unbuffered Mode: V<sub>DD</sub> = +12V, V<sub>SS</sub> = 0V; Full-Buffered Mode: V<sub>DD</sub> = +12V, V<sub>SS</sub> = -5V; GND = 0V, REFH = +5V, REFL = 0V, T<sub>A</sub> = T<sub>MIN</sub> to T<sub>MAX</sub>, unless otherwise noted.)

| PARAMETER   | SYMBOL                              | CONDITIONS   | UNBUFFERED MODE<br>(Note 1) |      |                      | FULL-BUFFERED MODE<br>(Note 2) |      |                    | UNITS |
|---|-------------------------------------|--|-----------------------------|------|----------------------|--------------------------------|------|--------------------|-------|
|   |                                     |  | MIN                         | TYP  | MAX                  | MIN                            | TYP  | MAX                |       |
| <b>STATIC PERFORMANCE</b>                             |                                     |  |                             |      |                      |                                |      |                    |       |
| Resolution  |                                     |  | 8                           |      |                      | 8                              |      |                    | Bits  |
| Relative Accuracy<br>(Note 3)                         | RLE                                 |  |                             | ±0.3 | ±1.0                 |                                | ±0.3 | ±1.0               | LSB   |
| Differential Nonlinearity<br>(Note 4)                 | DNL                                 | Guaranteed monotonic   |                             | ±0.3 | ±1.0                 |                                | ±0.3 | ±1.0               | LSB   |
| Full-Scale Error                                      | FSE                                 | R <sub>LOAD</sub> = open   |                             |      | ±1/2                 |                                |      |                    | LSB   |
| Gain Error (Note 5)                                   |                                     | R <sub>LOAD</sub> = open   |                             |      |                      |                                | -0.2 |                    | %     |
|   |                                     | R <sub>LOAD</sub> = 5kΩ  |                             |      |                      | 0.0                            | -1.3 | -2.5               | %     |
| Zero-Code Error                                       |                                     |  |                             |      | ±5                   |                                |      | ±60                | mV    |
| Zero-Code Tempco                                      |                                     |  |                             | ±5   |                      |                                | ±100 |                    | μV/°C |
| DAC Output Resistance                                 | R <sub>OUT</sub>                    |  | 8.5k                        | 13k  | 20k                  |                                | 55   | 100                | Ω     |
| DAC Output Resistance Match                           | ΔR <sub>OUT</sub> /R <sub>OUT</sub> |  |                             | 0.5  |                      |                                | 5.0  |                    | %     |
| V <sub>DD</sub> Supply Rejection Ratio<br>(Note 6)    | PSRR-V <sub>DD</sub>                | DAC code = 55 (hex)  |                             | 0.1  | 1.0                  |                                | 0.3  | 2.0                | mV/V  |
| V <sub>SS</sub> Supply Rejection Ratio<br>(Notes 4,6) | PSRR-V <sub>SS</sub>                | DAC code = 55 (hex)  |                             | 0.1  | 1.0                  |                                | 0.8  | 5.0                | mV/V  |
| <b>REFERENCE INPUT</b>                                |                                     |  |                             |      |                      |                                |      |                    |       |
| Voltage Range<br>(Note 7)                             | REFH                                | REFH - REFL = 11V<br>max   | REFL                        |      | V <sub>DD</sub> -3   | REFL                           |      | V <sub>DD</sub> -3 | V     |
|   | REFL                                |  | V <sub>SS</sub>             | REFH | V <sub>SS</sub> +1.5 | REFH                           |      |                    |       |
| Input Resistance<br>(Note 8)                          | REFH1/REFL1,<br>or<br>REFH2/REFL2   | DAC code = 55 (hex)  | 2.0                         | 3.4  |                      | 2.0                            | 3.4  |                    | kΩ    |
| Input Capacitance                                     | C <sub>REFH</sub>                   | DAC loaded with 0s   |                             | 40   |                      |                                | 40   |                    | pF    |
|   |                                     | DAC loaded with 1s   |                             | 250  |                      |                                | 125  |                    |       |
| AC Feedthrough  |                                     | REFH=10kHz, 0-10V <sub>p-p</sub><br>sinewave, all DACs at<br>code 00 (hex) |                             | -70  |                      |                                | -70  |                    | dB    |

# Octal 8-Bit Serial DACs with Output Buffer

MAX528/MAX529

## ELECTRICAL CHARACTERISTICS - MAX528 (continued)

(Unbuffered Mode:  $V_{DD} = +12V$ ,  $V_{SS} = 0V$ ; Full-Buffered Mode:  $V_{DD} = +12V$ ,  $V_{SS} = -5V$ ;  $GND = 0V$ ,  $REFH = +5V$ ,  $REFL = 0V$ ,  $T_A = T_{MIN}$  to  $T_{MAX}$ , unless otherwise noted.)

| PARAMETER                           | SYMBOL   | CONDITIONS   | UNBUFFERED MODE<br>(Note 1) |     |      | FULL-BUFFERED MODE<br>(Note 2) |     |      | UNITS   |
|-------------------------------------|----------|--|-----------------------------|-----|------|--------------------------------|-----|------|---------|
|                                     |          |  | MIN                         | TYP | MAX  | MIN                            | TYP | MAX  |         |
| <b>POWER REQUIREMENTS</b>           |          |  |                             |     |      |                                |     |      |         |
| Positive Supply Range               | $V_{DD}$ |  | 10.8                        |     | 16.5 | 10.8                           |     | 16.5 | V       |
| Negative Supply Range               | $V_{SS}$ |  | 0                           |     | -5.5 | -1.5                           |     | -5.5 | V       |
| Positive Supply Current             | $I_{DD}$ | $DIN = CLK = 0V$ ,<br>$CS = SHDN = 5V$   |                             | 0.3 | 1.0  |                                | 5.5 | 9.0  | mA      |
| Negative Supply Current             | $I_{SS}$ | $DIN = CLK = 0V$ ,<br>$CS = SHDN = 5V$   |                             | 0.1 | 0.5  |                                | 5.5 | 9.0  | mA      |
| $I_{DD}$ at Shutdown                | $I_{DD}$ | $SHDN = low$   |                             |     | 50   |                                |     | 50   | $\mu A$ |
| $I_{SS}$ at Shutdown                | $I_{SS}$ | $SHDN = low$   |                             |     | 50   |                                |     | 50   | $\mu A$ |
| <b>DYNAMIC PERFORMANCE (Note 7)</b> |          |  |                             |     |      |                                |     |      |         |
| $V_{OUT}$ Settling Time             |          | To $\pm 1/2LSB$ ; $C_{LOAD} = 20pF$ , from rising edge of $CS$   |                             | 1   | 3    |                                | 0.6 | 2.0  | $\mu s$ |
| Digital Coupling                    |          | Serial input: 1MHz CLK, DIN alternating 1s and 0s (0.5MHz), $C_L = 20pF$ , 0V to 5V input levels at CLK, DIN |                             | 20  |      |                                | 20  |      | mVp-p   |
| Crosstalk                           |          | Full-scale output transition on all 7 other channels ( $CS$ high)  |                             | 40  |      |                                | 20  |      | nV-s    |
|                                     |          | 1LSB output transition on all 7 other channels ( $CS$ high)  |                             | 2   |      |                                | 10  |      |         |

## DIGITAL AND SWITCHING CHARACTERISTICS - MAX528

( $V_{DD} = +12V$ ,  $V_{SS} = -5V$ ,  $REFH = +5V$ ,  $REFL = 0V$ ,  $T_A = T_{MIN}$  to  $T_{MAX}$ , unless otherwise noted.)

| PARAMETER   | SYMBOL    | CONDITIONS                 | MIN | TYP | MAX      | UNITS   |
|---|-----------|----------------------------|-----|-----|----------|---------|
| <b>DIGITAL INPUTS DIN, CLK, CS, SHDN</b>  |           |                            |     |     |          |         |
| Input High Voltage  | $V_{INH}$ | DIN, CLK, $\overline{CS}$  | 2.4 |     |          | V       |
| Input Low Voltage   | $V_{INL}$ | DIN, CLK, $\overline{CS}$  |     |     | 0.8      | V       |
| Input High Voltage  | $V_{INH}$ | $SHDN$                     | 3.0 |     |          | V       |
| Input Low Voltage   | $V_{INL}$ | $SHDN$                     |     |     | 0.5      | V       |
| Input Hysteresis  |           | DIN, CLK, $\overline{CS}$  |     | 0.1 |          | V       |
| Input Leakage Current   |           | $V_{IN} = 0V$ or $V_{DD}$  |     |     | $\pm 1$  | $\mu A$ |
| Input Capacitance (Note 7)  |           |                            |     |     | 10       | pF      |
| <b>DIGITAL OUTPUT, DOUT, open drain output, 1k<math>\Omega</math> pull-up resistor to +5V</b> |           |                            |     |     |          |         |
| Output Low Voltage  | $V_{OL}$  | $I_{SINK} = 5mA$           |     |     | 0.4      | V       |
| Output High Leakage   | $I_{LKG}$ | $V_{OUT} = 0V$ to $V_{DD}$ |     |     | $\pm 10$ | $\mu A$ |
| Output High Capacitance (Note 7)  | $C_{OUT}$ |                            |     |     | 15       | pF      |

## Octal 8-Bit Serial DACs with Output Buffer

### DIGITAL AND SWITCHING CHARACTERISTICS - MAX528 (continued)

(V<sub>DD</sub> = +12V, V<sub>SS</sub> = -5V, REFH = +5V, REFL = 0V, T<sub>A</sub> = T<sub>MIN</sub> to T<sub>MAX</sub>, unless otherwise noted.)

| PARAMETER   | SYMBOL            | CONDITIONS  | MIN            | TYP | MAX | UNITS |
|---|-------------------|---|----------------|-----|-----|-------|
| <b>SWITCHING CHARACTERISTICS</b>                      |                   |   |                |     |     |       |
| CLK Pulse Width High                                  | t <sub>CH</sub>   |   | 80             |     |     | ns    |
| CLK Pulse Width Low                                   | t <sub>CL</sub>   |   | 80             |     |     | ns    |
| DIN to CLK High Setup                                 | t <sub>DS</sub>   |   | 40             |     |     | ns    |
| DIN to CLK High Hold                                  | t <sub>DH</sub>   |   | 15             |     |     | ns    |
| $\overline{\text{CS}}$ Low to CLK High Setup          | t <sub>CS0</sub>  |   | 50             |     |     | ns    |
| $\overline{\text{CS}}$ High to CLK High Setup         | t <sub>CS1</sub>  |   | 50             |     |     | ns    |
| Delay, CLK Low to Low $\overline{\text{CS}}$          | t <sub>CSH0</sub> |   | 0              |     |     | ns    |
| Delay, CLK High to High $\overline{\text{CS}}$        | t <sub>CSH1</sub> |   | 50             |     |     | ns    |
| $\overline{\text{CS}}$ Pulse Width                    | t <sub>CSW</sub>  |   | 130            |     |     | ns    |
| CLK High to DOUT Data Valid (Note 9)                  | t <sub>DO</sub>   | C <sub>LOAD</sub> = 20pF, R <sub>pullup</sub> = 1k $\Omega$ to 5V | 15<br>(Note 7) |     | 130 | ns    |
| $\overline{\text{CS}}$ Low to DOUT Enable (Note 10)   | t <sub>DV</sub>   | C <sub>LOAD</sub> = 20pF, R <sub>pullup</sub> = 1k $\Omega$ to 5V |                |     | 90  | ns    |
| $\overline{\text{CS}}$ High to DOUT Disable (Note 10) | t <sub>TR</sub>   | C <sub>LOAD</sub> = 20pF, R <sub>pullup</sub> = 1k $\Omega$ to 5V |                |     | 90  | ns    |

**Note 1:** Unbuffered mode – buffers disabled. No output load.

**Note 2:** Full-buffered mode – buffers enabled; bipolar output mode; R<sub>LOAD</sub> = 5k $\Omega$ .

**Note 3:** Relative accuracy in unbuffered mode guaranteed by relative accuracy test in full-buffered mode.

**Note 4:** Specification in Unbuffered Mode column guaranteed by design only. Not subject to test.

**Note 5:** Gain error with full-buffered mode enabled = no-load gain error - (DAC output resistance/R<sub>LOAD</sub>). Example: -0.2% typ no-load error - (55 $\Omega$ /5k $\Omega$ ) = -1.3% typ error for 5k $\Omega$  load.

**Note 6:** PSRR tested over supply range specified under power requirements; PSRR = (V<sub>OUT1</sub> - V<sub>OUT2</sub>)/(V<sub>SUPPLY1</sub> - V<sub>SUPPLY2</sub>).

**Note 7:** Guaranteed by design, not subject to test.

**Note 8:** Input resistance tested only under Unbuffered Mode conditions in Note 1 above.

**Note 9:** V<sub>OH</sub> = 2.4V, V<sub>OL</sub> = 0.8V.

**Note 10:** t<sub>DV</sub> and t<sub>TR</sub> are defined as the time required for DOUT to change 0.5V.

# Octal 8-Bit Serial DACs with Output Buffer

**MAX528/MAX529**

## ABSOLUTE MAXIMUM RATINGS - MAX529

|   |  |
|---|--|
| V <sub>DD</sub> to GND                            | -0.3V to +7V                                       |
| V <sub>DD</sub> to V <sub>SS</sub>                | -0.3V to +12V                                      |
| V <sub>SS</sub> to GND                            | -7V to +0.3V                                       |
| REFH1 - REFL1, REFH2 - REFL2                      | -0.3V to +12V                                      |
| REFH1 - V <sub>SS</sub> , REFH2 - V <sub>SS</sub> | +12V   |
| REFH1, REFH2                                      | REFL <sub>-</sub> - 0.3V to V <sub>DD</sub> + 0.3V |
| REFL1, REFL2                                      | V <sub>SS</sub> - 0.3V to REFH <sub>+</sub> + 0.3V |
| OUT(1-8)  | V <sub>SS</sub> - 0.3V to V <sub>DD</sub> + 0.3V   |
| OUT(1-8) to V <sub>SS</sub>                       | +12V   |
| OUT(1-8) Current                                  | ±20mA  |
| DIN, CLK, CS, DOUT                                | -0.3V to V <sub>DD</sub> + 0.3V                    |
| SHDN  | V <sub>SS</sub> - 0.3V to V <sub>DD</sub> + 0.3V   |

|   |                 |
|---|-----------------|
| DOUT Current  | ±20mA           |
| Continuous Power Dissipation (T <sub>A</sub> = +70°C) |                 |
| Plastic DIP (derate 11.11mW/°C above +70°C)           | 889mW           |
| Wide SO (derate 11.76mW/°C above +70°C)               | 941mW           |
| CERDIP (derate 11.11mW/°C above +70°C)                | 889mW           |
| Operating Temperature Ranges:                         |                 |
| MAX528C   | 0°C to +70°C    |
| MAX528E   | -40°C to +85°C  |
| MAX528MJP   | -55°C to +125°C |
| Storage Temperature Range                             | -65°C to +160°C |
| Lead Temperature (soldering, 10 sec)                  | +300°C          |

Stresses beyond those listed under "Absolute Maximum Ratings" may cause permanent damage to the device. These are stress ratings only, and functional operation of the device at these or any other conditions beyond those indicated in the operational sections of the specifications is not implied. Exposure to absolute maximum rating conditions for extended periods may affect device reliability.

## ELECTRICAL CHARACTERISTICS - MAX529

(Unbuffered Mode: V<sub>DD</sub> = +5V, V<sub>SS</sub> = GND = 0V, REFH = +2.5V, REFL = 0V; Full-Buffered Mode: V<sub>DD</sub> = +5V, V<sub>SS</sub> = -5V, GND = 0V, REFH = +2.5V, REFL = -2.5V, T<sub>A</sub> = T<sub>MIN</sub> to T<sub>MAX</sub>, unless otherwise noted.)

| PARAMETER   | SYMBOL                              | CONDITIONS               | UNBUFFERED MODE<br>(Note 1) |                        |                       | FULL-BUFFERED MODE<br>(Note 2) |      |      | UNITS |
|---|-------------------------------------|--------------------------|-----------------------------|------------------------|-----------------------|--------------------------------|------|------|-------|
|   |                                     |                          | MIN                         | TYP                    | MAX                   | MIN                            | TYP  | MAX  |       |
| <b>STATIC PERFORMANCE</b>                             |                                     |                          |                             |                        |                       |                                |      |      |       |
| Resolution  |                                     |                          | 8                           |                        |                       | 8                              |      |      | Bits  |
| Relative Accuracy<br>(Note 3)                         | RLE                                 |                          |                             | ±0.3                   | ±1.0                  |                                | ±0.3 | ±1.0 | LSB   |
| Differential Nonlinearity<br>(Note 4)                 | DNL                                 | Guaranteed monotonic     |                             | ±0.3                   | ±1.0                  |                                | ±0.3 | ±1.0 | LSB   |
| Full-Scale Error                                      | FSE                                 | R <sub>LOAD</sub> = open |                             |                        | ±1/2                  |                                |      |      | LSB   |
| Gain Error (Note 5)                                   |                                     | R <sub>LOAD</sub> = open |                             |                        |                       |                                | -0.2 |      | %     |
|   |                                     | R <sub>LOAD</sub> = 5kΩ  |                             |                        |                       | 0.0                            | -1.3 | -2.5 | %     |
| Unipolar Offset Error                                 |                                     | DAC code = 00 (hex)      |                             |                        | ±5                    |                                |      |      | mV    |
| Bipolar Offset Error                                  |                                     | DAC code = 80 (hex)      |                             |                        |                       |                                |      | ±60  | mV    |
| Offset Error Tempco                                   |                                     |                          |                             | ±5                     |                       |                                | ±100 |      | μV/°C |
| DAC Output Resistance                                 | R <sub>OUT</sub>                    |                          | 8.5k                        | 13k                    | 20k                   |                                | 55   | 100  | Ω     |
| DAC Output Resistance Match                           | ΔR <sub>OUT</sub> /R <sub>OUT</sub> |                          |                             | 0.5                    |                       |                                | 5.0  |      | %     |
| V <sub>DD</sub> Supply Rejection Ratio<br>(Note 6)    | PSRR-V <sub>DD</sub>                | DAC code = 55 (hex)      |                             | 1.5                    | 5                     |                                | 3    | 10   | mV/V  |
| V <sub>SS</sub> Supply Rejection Ratio<br>(Notes 4,6) | PSRR-V <sub>SS</sub>                | DAC code = 55 (hex)      |                             | 0.3                    | 2                     |                                | 1    | 5    | mV/V  |
| <b>REFERENCE INPUT</b>                                |                                     |                          |                             |                        |                       |                                |      |      |       |
| Voltage Range<br>(Note 7)                             | REFH                                |                          | REFL                        | V <sub>DD</sub> - 2.25 | REFL                  | V <sub>DD</sub> - 2.25         |      |      | V     |
|   | REFL                                |                          | V <sub>SS</sub>             | REFH                   | V <sub>SS</sub> + 1.5 | REFH                           |      |      |       |
| Input Resistance<br>(Note 8)                          | REFH1/REFL1,<br>or<br>REFH2/REFL2   | DAC code = 55 (hex)      | 2.0                         | 3.4                    |                       | 2.0                            | 3.4  |      | kΩ    |
| Input Capacitance                                     | C <sub>REFH</sub>                   | DAC loaded with 0s       |                             | 40                     |                       |                                | 40   |      | pF    |
|   |                                     | DAC loaded with 1s       |                             | 250                    |                       |                                | 125  |      |       |

## Octal 8-Bit Serial DACs with Output Buffer

### ELECTRICAL CHARACTERISTICS - MAX529 (continued)

(Unbuffered Mode:  $V_{DD} = +5V$ ,  $V_{SS} = GND = ON$ ,  $REFH = +2.5V$ ,  $REFL = 0V$ ; Full-Buffered Mode:  $V_{DD} = +5V$ ,  $V_{SS} = -5V$ ,  $GND = 0V$ ,  $REFH = +2.5V$ ,  $REFL = -2.5V$ ,  $T_A = T_{MIN}$  to  $T_{MAX}$ , unless otherwise noted.)

| PARAMETER                           | SYMBOL   | CONDITIONS   | UNBUFFERED MODE<br>(Note 1) |     |      | FULL-BUFFERED MODE<br>(Note 2) |     |      | UNITS   |
|-------------------------------------|----------|--|-----------------------------|-----|------|--------------------------------|-----|------|---------|
|                                     |          |  | MIN                         | TYP | MAX  | MIN                            | TYP | MAX  |         |
| AC Feedthrough                      |          | $REFH = 10kHz$ , 0-2.5V <sub>p-p</sub> sinewave, all DACs at code 00 (hex)   |                             | -70 |      |                                | -70 |      | dB      |
| <b>POWER REQUIREMENTS</b>           |          |  |                             |     |      |                                |     |      |         |
| Positive Supply Range               | $V_{DD}$ |  | 4.75                        |     | 5.25 | 4.75                           |     | 5.25 | V       |
| Negative Supply Range               | $V_{SS}$ |  | 0                           |     | -5.5 | -4.5                           |     | -5.5 | V       |
| Positive Supply Current             | $I_{DD}$ | $DIN = CLK = 0V$ ,<br>$CS = SHDN = 5V$   |                             | 0.3 | 1.0  |                                | 5.5 | 9.0  | mA      |
| Negative Supply Current             | $I_{SS}$ | $DIN = CLK = 0V$ ,<br>$CS = SHDN = 5V$   |                             | 0.1 | 0.5  |                                | 5.5 | 9.0  | mA      |
| $I_{DD}$ at Shutdown                | $I_{DD}$ | $\overline{SHDN} = low$  |                             |     | 50   |                                |     | 50   | $\mu A$ |
| $I_{SS}$ at Shutdown                | $I_{SS}$ | $\overline{SHDN} = low$  |                             |     | 50   |                                |     | 50   | $\mu A$ |
| <b>DYNAMIC PERFORMANCE (Note 7)</b> |          |  |                             |     |      |                                |     |      |         |
| $V_{OUT}$ Settling Time             |          | To $\pm 1/2LSB$ , $C_{LOAD} = 20pF$ ,<br>from rising edge of $CS$  |                             | 1   | 3    |                                | 0.6 | 2.0  | $\mu s$ |
| Digital Coupling                    |          | Serial input: 1MHz<br>CLK, DIN alternating<br>1s and 0s (0.5MHz),<br>$C_L = 20pF$ , 0V to 5V<br>input levels at CLK, DIN |                             | 20  |      |                                | 20  |      | mVp-p   |
| Crosstalk                           |          | Full-scale output transition<br>on all 7 other<br>channels ( $CS$ high)  |                             | 40  |      |                                | 20  |      | nV-s    |
|                                     |          | 1LSB output transition<br>on all 7 other channels<br>( $CS$ high)  |                             | 2   |      |                                | 10  |      |         |

### DIGITAL AND SWITCHING CHARACTERISTICS - MAX529

( $V_{DD} = +5V$ ,  $V_{SS} = -5V$ ,  $REFH = +2.5V$ ,  $REFL = -2.5V$ ,  $T_A = T_{MIN}$  to  $T_{MAX}$ , unless otherwise noted.)

| PARAMETER  | SYMBOL    | CONDITIONS                 | MIN | TYP | MAX      | UNITS   |
|--|-----------|----------------------------|-----|-----|----------|---------|
| <b>DIGITAL INPUTS <math>DIN</math>, <math>CLK</math>, <math>CS</math>, <math>\overline{SHDN}</math></b>      |           |                            |     |     |          |         |
| $\overline{SHDN}$  |           |                            |     |     |          |         |
| Input High Voltage   | $V_{INH}$ | $DIN$ , $CLK$ , $CS$       | 2.4 |     |          | V       |
| Input Low Voltage  | $V_{INL}$ | $DIN$ , $CLK$ , $CS$       |     |     | 0.8      | V       |
| Input High Voltage   | $V_{INH}$ | $\overline{SHDN}$          | 3.0 |     |          | V       |
| Input Low Voltage  | $V_{INL}$ | $\overline{SHDN}$          |     |     | 0.5      | V       |
| Input Hysteresis   |           | $DIN$ , $CLK$ , $CS$       |     | 0.1 |          | V       |
| Input Leakage Current  |           | $V_{IN} = 0V$ or $V_{DD}$  |     |     | $\pm 1$  | $\mu A$ |
| Input Capacitance (Note 7)   |           |                            |     |     | 10       | pF      |
| <b>DIGITAL OUTPUT, <math>DOUT</math>, open drain output, 1.3k<math>\Omega</math> pull-up resistor to +5V</b> |           |                            |     |     |          |         |
| Output Low Voltage   | $V_{OL}$  | $I_{SINK} = 3.5mA$         |     |     | 0.4      | V       |
| Output High Leakage  | $I_{LKG}$ | $V_{OUT} = 0V$ to $V_{DD}$ |     |     | $\pm 10$ | $\mu A$ |
| Output High Capacitance (Note 7)   | $C_{OUT}$ |                            |     |     | 15       | pF      |

# Octal 8-Bit Serial DACs with Output Buffer

MAX528/MAX529

## DIGITAL AND SWITCHING CHARACTERISTICS - MAX529 (continued)

(V<sub>DD</sub> = +5V, V<sub>SS</sub> = -5V, REFH = +2.5V, REFL = -2.5V, T<sub>A</sub> = T<sub>MIN</sub> to T<sub>MAX</sub>, unless otherwise noted.)

| PARAMETER                            | SYMBOL            | CONDITIONS  | MIN         | TYP | MAX | UNITS |
|--------------------------------------|-------------------|---|-------------|-----|-----|-------|
| <b>SWITCHING CHARACTERISTICS</b>     |                   |   |             |     |     |       |
| CLK Pulse Width High                 | t <sub>CH</sub>   |   | 125         |     |     | ns    |
| CLK Pulse Width Low                  | t <sub>CL</sub>   |   | 125         |     |     | ns    |
| DIN to CLK High Setup                | t <sub>DS</sub>   |   | 50          |     |     | ns    |
| DIN to CLK High Hold                 | t <sub>DH</sub>   |   | 20          |     |     | ns    |
| CS Low to CLK High Setup             | t <sub>CSS0</sub> |   | 50          |     |     | ns    |
| CS High to CLK High Setup            | t <sub>CSS1</sub> |   | 50          |     |     | ns    |
| Delay, CLK Low to Low CS             | t <sub>CSH0</sub> |   | 0           |     |     | ns    |
| Delay, CLK High to High CS           | t <sub>CSH1</sub> |   | 50          |     |     | ns    |
| CS Pulse Width                       | t <sub>CSW</sub>  |   | 300         |     |     | ns    |
| CLK High to DOUT Data Valid (Note 9) | t <sub>DO</sub>   | C <sub>LOAD</sub> = 20pF, R <sub>pullup</sub> = 1kΩ to 5V | 20 (Note 7) |     | 200 | ns    |
| CS Low to DOUT Enable (Note 10)      | t <sub>DV</sub>   | C <sub>LOAD</sub> = 20pF, R <sub>pullup</sub> = 1kΩ to 5V |             |     | 120 | ns    |
| CS High to DOUT Disable (Note 10)    | t <sub>TR</sub>   | C <sub>LOAD</sub> = 20pF, R <sub>pullup</sub> = 1kΩ to 5V |             |     | 120 | ns    |

**Note 1:** Unbuffered mode – buffers disabled. No output load.

**Note 2:** Full-buffered mode – buffers enabled; bipolar output mode; R<sub>LOAD</sub> = 5kΩ.

**Note 3:** Relative accuracy in unbuffered mode guaranteed by relative accuracy test in full-buffered mode.

**Note 4:** Specification in Unbuffered Mode column guaranteed by design only. Not subject to test.

**Note 5:** Gain error with full-buffered mode enabled = no-load gain error - (DAC output resistance/R<sub>LOAD</sub>). Example: -0.2% typ no-load error - (55Ω/5kΩ) = -1.3% typ error for 5kΩ load.

**Note 6:** PSRR tested over supply range specified under power requirements; PSRR = (V<sub>OUT1</sub> - V<sub>OUT2</sub>)/(V<sub>SUPPLY1</sub> - V<sub>SUPPLY2</sub>).

**Note 7:** Guaranteed by design, not subject to test.

**Note 8:** Input resistance tested only under Unbuffered Mode conditions in Note 1 above.

**Note 9:** V<sub>OH</sub> = 2.4V, V<sub>OL</sub> = 0.8V.

**Note 10:** t<sub>DV</sub> and t<sub>TR</sub> are defined as the time required for DOUT to change 0.5V.

## Typical Operating Characteristics

### MAX528

**MAX528  
HALF-BUFFERED GAIN AND LINEARITY  
ERROR vs. V<sub>IN</sub> (OUTPUT VOLTAGE OF  
R-2R LADDER)**



**MAX528  
FULL-BUFFERED STEP RESPONSE  
FOR VARIOUS CODES, NO LOAD**

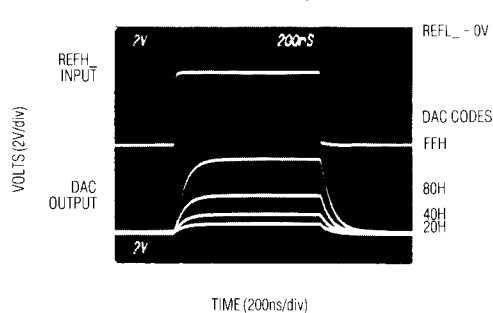

# Octal 8-Bit Serial DACs with Output Buffer

## Typical Operating Characteristics (continued)

**MAX528**  
FULL-BUFFERED STEP RESPONSE



**MAX528**  
FULL-BUFFERED SETTLING TIME  
CODE CHANGE (00-FF-00), NO LOAD



**MAX528**  
FULL-BUFFERED SETTLING TIME  
CODE CHANGE (00-FF-00)

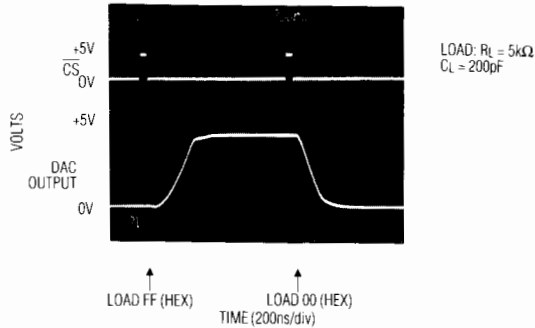

**MAX528**  
UNBUFFERED OFF-CHANNEL GLITCH  
CODE CHANGE (00-FF-00), NO LOAD



**MAX528**  
FULL-BUFFERED OFF-CHANNEL GLITCH  
CODE CHANGE (00-FF-00), NO LOAD



**MAX528**  
UNBUFFERED OFF-CHANNEL GLITCH  
CODE CHANGE (7F-80-7F), NO LOAD





# Octal 8-Bit Serial DACs with Output Buffer

## Typical Operating Characteristics (continued)

**MAX528/MAX529**

**MAX528**  
FULL-BUFFERED OFF-CHANNEL GLITCH  
CODE CHANGE (7F-80-7F), NO LOAD

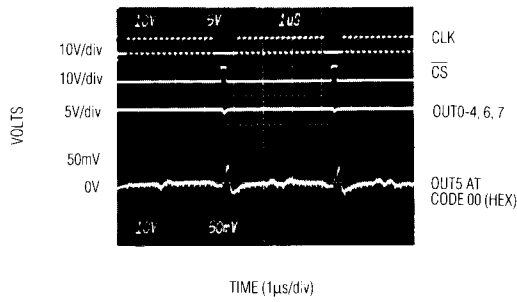

**MAX528**  
UNBUFFERED OUTPUT  
GLITCH FILTERING

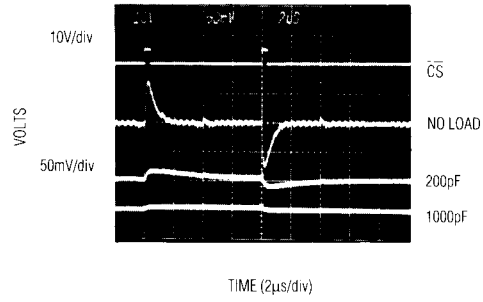

**MAX529**  
HALF-BUFFERED GAIN AND LINEARITY  
ERROR vs.  $V_{IN}$  (OUTPUT VOLTAGE OF  
R-2R LADDER)



**MAX529**

**MAX529**  
FULL-BUFFERED STEP RESPONSE  
FOR VARIOUS CODES, NO LOAD



**MAX529**  
FULL-BUFFERED STEP RESPONSE



**MAX529**  
FULL-BUFFERED SETTLING TIME  
CODE CHANGE (00-FF-00), NO LOAD

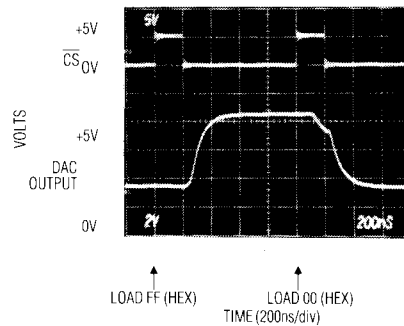

# Octal 8-Bit Serial DACs with Output Buffer

## Typical Operating Characteristics (continued)

**MAX529**  
FULL-BUFFERED SETTLING TIME  
CODE CHANGE (00-FF-00)



**MAX529**  
UNBUFFERED OFF-CHANNEL GLITCH  
CODE CHANGE (00-FF-00), NO LOAD



**MAX529**  
FULL-BUFFERED OFF-CHANNEL GLITCH  
CODE CHANGE (00-FF-00), NO LOAD

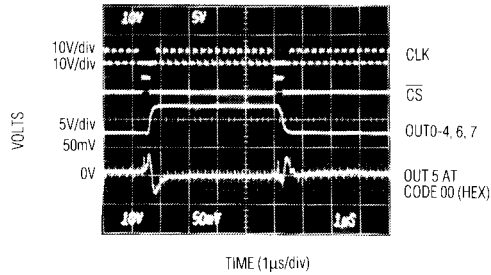

**MAX529**  
UNBUFFERED OFF-CHANNEL GLITCH  
CODE CHANGE (00-FF-00), NO LOAD

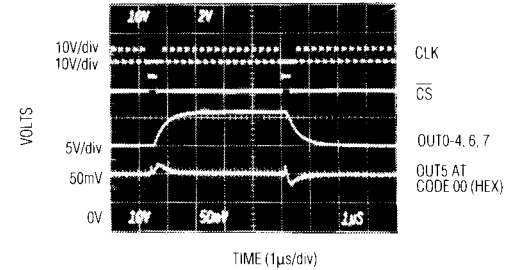

**MAX529**  
UNBUFFERED OUTPUT  
GLITCH FILTERING



# Octal, 8-Bit, Serial DACs with Output Buffer

## Pin Description

**MAX528/MAX529**

| PIN          |     |               | NAME              | FUNCTION   |
|--------------|-----|---------------|-------------------|--|
| SSOP         | DIP | SO            |                   |  |
| 5, 7, 18, 20 | –   | 1, 12, 13, 24 | N.C.              | No Connect. These pins are not internally connected.   |
| 1            | 1   | 2             | REFL1             | Reference 1 Input Low. Must be more negative than REFH1 and more positive than V <sub>SS</sub> .   |
| 2            | 2   | 3             | REFH1             | Reference 1 Input High. Must be more positive than REFL1 and more negative than V <sub>DD</sub> .  |
| 3            | 3   | 4             | OUT0              | Output Voltage 0. The product of the digital code for channel 0 and (REFH1 - REFL1), referenced to REFL1.  |
| 4            | 4   | 5             | OUT1              | Output Voltage 1. The product of the digital code for channel 1 and (REFH1 - REFL1), referenced to REFL1.  |
| 6            | 5   | 6             | OUT2              | Output Voltage 2. The product of the digital code for channel 2 and (REFH1 - REFL1), referenced to REFL1.  |
| 8            | 6   | 7             | OUT3              | Output Voltage 3. The product of the digital code for channel 3 and (REFH1 - REFL1), referenced to REFL1.  |
| 9            | 7   | 8             | V <sub>DD</sub>   | Positive Analog and Digital Supply.  |
| 10           | 8   | 9             | DIN               | Digital Input. CMOS and TTL compatible serial programming input.   |
| 11           | 9   | 10            | CLK               | Clock Input. CMOS and TTL compatible clock input.  |
| 12           | 10  | 11            | DOUT              | Digital Output. Open-drain, N-channel, FET output, requires external pull-up resistor; serial data output, shifted 16 bits from DIN.   |
| 13           | 11  | 14            | GND               | Digital Ground. Connect to 0V. (Analog signals are referenced to their respective REFL voltage, not GND).  |
| 14           | 12  | 15            | $\overline{CS}$   | CHIP SELECT. Connect to logic low to program serially. Connect to logic high to latch data and turn off internal shift register. Rising edge of $\overline{CS}$ transfers new data into data registers and changes DAC output. |
| 15           | 13  | 16            | $\overline{SHDN}$ | SHUTDOWN. Connect to logic high for normal operation, to GND for shutdown mode.  |
| 16           | 14  | 17            | V <sub>SS</sub>   | Negative Analog Supply. Connect to GND for single-supply operation. Connect to negative supply for bipolar DAC outputs.  |
| 17           | 15  | 18            | OUT4              | Output Voltage 4. The product of the digital code for channel 4 and (REFH2 - REFL2), referenced to REFL2.  |
| 19           | 16  | 19            | OUT5              | Output Voltage 5. The product of the digital code for channel 5 and (REFH2 - REFL2), referenced to REFL2.  |
| 21           | 17  | 20            | OUT6              | Output Voltage 6. The product of the digital code for channel 6 and (REFH2 - REFL2), referenced to REFL2.  |
| 22           | 18  | 21            | OUT7              | Output Voltage 7. The product of the digital code for channel 7 and (REFH2 - REFL2), referenced to REFL2.  |
| 23           | 19  | 22            | REFH2             | Reference 2 Input High. Must be more positive than REFL2 and more negative than V <sub>DD</sub> .  |
| 24           | 20  | 23            | REFL2             | Reference 2 Input Low. Must be more negative than REFH2 and more positive than V <sub>SS</sub> .   |

# Octal 8-Bit Serial DACs with Output Buffer

## Detailed Description

### Circuit Operation

The MAX528/MAX529 contain 8 latched digital-to-analog converters (DACs), 8 buffer amplifiers, 2 reference inputs, and serial control logic. Buffer amplifiers may also be bypassed by internal switches, allowing three output modes: unbuffered, full-buffered, and half-buffered.

Any or all of the 8 voltage outputs can be programmed with 16 serial data bits.

### DAC Output Range

The MAX528/MAX529 provide 8 voltage outputs (OUT0-OUT7) from 2 reference inputs. Each reference voltage has 2 input pins, REFH and REFL. The OUT0-OUT3 output voltages are derived from REFH1 and REFL1 while OUT4-OUT7 are derived from REFH2 and REFL2. For each reference, REFH must be more positive than REFL. A DAC output voltage is the product of its programmed 8-bit code and its reference input voltage. For example, the output voltage of OUT5 is:

$$OUT5 = (REFH2 - REFL2) (nn/256 + REFL2),$$

where  $nn$  = 8-bit code for OUT5, with a range of 0-255 (00 to FF hex.)

The reference inputs are independent of one another. REFH can range within 3V of  $V_{DD}$ . REFL can be as low as  $V_{SS}$  in unbuffered and half-buffered modes, but must be at least 1.5V above  $V_{SS}$  in full-buffered mode. For the MAX528,  $V_{SS}$  can be any negative voltage from -15V to 0V, provided that  $V_{DD}-V_{SS}$  is no more than 20V. For the MAX529,  $V_{SS}$  can be any negative voltage from 0V to -5V. In all modes, REFH must be no more than 12V greater than REFL.

Although the MAX528/MAX529 have a digital ground (GND) pin, they contain no internal analog ground. The upper and lower limits of any DAC output are the voltages to which REFH and REFL are connected.

### Shutdown

To conserve power, the MAX528/MAX529 can be shut down by pulling  $\overline{SHDN}$  low.  $V_{CC}$  and  $V_{SS}$  supply currents drop to less than 50 $\mu$ A, but reference current will still be drawn. Reference current is code dependent and can be reduced to nearly 0 (leakage only) by writing 0s to all DACs.

Note: To ensure that register data is retained during shutdown,  $\overline{CS}$  must be high when entering or leaving shutdown mode.

### Buffer Output Modes

DAC outputs can be programmed for one of three buffer modes: unbuffered, full-buffered, and half-buffered. Buffers must be activated in pairs, and full- or half-buffered mode must be selected in banks of four as shown in Table 1 (see *Digital Interface* section).

**Table 1. Buffer Output-Mode Selection Codes (Address 00 hex, D6 = X, D7 = 1)**

| Mode                         | OUT0, 1 | OUT2, 3 | OUT4, 5 | OUT5, 6 |
|------------------------------|---------|---------|---------|---------|
| <b>Unbuffered (D0, D3=X)</b> | D5 = 0  | D4 = 0  | D2 = 0  | D1 = 0  |
| <b>Full-Buffered</b>         | D5 = 1  | D4 = 1  | D2 = 1  | D1 = 1  |
|                              | D3 = 1  |         | D0 = 1  |         |
| <b>Half-Buffered</b>         | D5 = 1  | D4 = 1  | D2 = 1  | D1 = 1  |
|                              | D3 = 0  |         | D0 = 0  |         |

### Unbuffered Mode

Unbuffered mode connects the internal 20k $\Omega$  R-2R DAC network (Figure 1) directly to OUT. Buffer circuitry is disabled, reducing power consumption as well as offset errors contributed by the internal buffer amplifier (see *Electrical Characteristics*). Driving high-resistance loads (1M $\Omega$  and up) improves accuracy. Output range in unbuffered mode is from the negative supply rail ( $V_{SS}$ ) to  $V_{DD} - 3V$  for the MAX528 ( $V_{SS}$  to  $V_{DD} - 2.25V$  for MAX529).

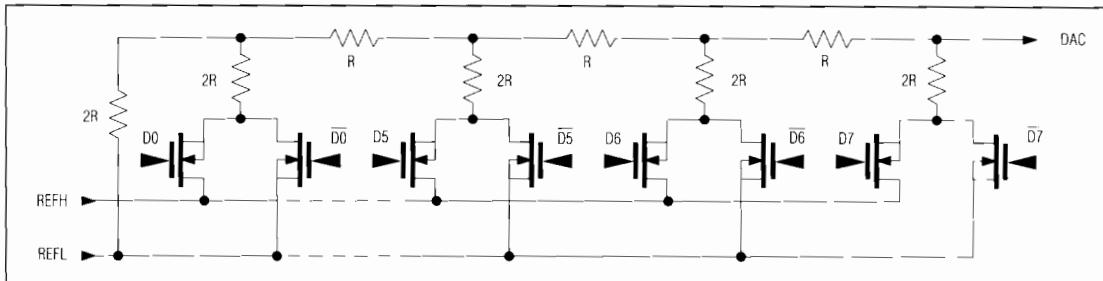

Figure 1. R-2R Inverted Ladder DAC Structure

## Octal 8-Bit Serial DACs with Output Buffer

Unbuffered mode also operates effectively with lower resistance loads, but output loading may generate gain (full-scale) error. This will not affect linearity because DAC output resistance (between 8.5kΩ and 20kΩ) does not change with code. The magnitude of the expected gain error is the ratio of the DAC output impedance (typically 13kΩ) to the DC load resistance at the output.

Another advantage of unbuffered operation is that output filtering uses small capacitors and no resistors. The Unbuffered Output Glitch Filtering photos in the *Typical Operating Characteristics* show the feedthrough effect of changing all channels but one from full-scale to zero. On the rising edge of CS (top trace), energy is coupled into the unchanged channel (2nd trace, unfiltered), producing a 70mV, 1μs pulse for the MAX528, and a 40mV, 5μs pulse for the MAX529. The third and fourth traces of the MAX528 photo show how this pulse is suppressed using 200pF and 1000pF load capacitors with the MAX528. The third trace of the MAX529 photo shows this pulse suppression using a 200pF load capacitor with the MAX529.

### Full-Buffered Mode

Full-buffered mode (Figure 2) activates both sections of the buffer amplifier, lowering the output impedance to typically 55Ω and allowing +5mA/-2mA output currents to be supplied. The buffer amplifier output swing is from  $V_{SS} + 1.5V$  to  $V_{DD} - 3V$  ( $V_{SS} = +1.5V$  to  $V_{DD} - 2.25V$  for MAX529). The key advantage of this mode is that changes in load current cause minimal output change.

### Half-Buffered Mode

Half-buffered mode (Figure 3) activates only the top half of the output stage, and therefore sources current only. Its advantage is that it maintains output swing to  $V_{SS}$  while

providing a buffered output. Output swing is from  $V_{SS}$  to  $V_{DD} - 3V$  ( $V_{SS} = +1.5V$  to  $V_{DD} - 2.25V$  for MAX529). Current consumption is reduced to typically 1.7mA (compared to 5.5mA for full-buffered) if all buffers use half-buffered mode.

### Using an AC Reference with the MAX528

In applications where the reference has AC signal components, the MAX528 has multiplying capability within the REFH and REFL specifications. Figure 4 shows a technique for attenuating an AC signal by superimposing it on a DC voltage prior to REFH. As the DAC code changes, the AC output changes, as does the DC level. The output DC level is removed by capacitively coupling to the next stage. Note that the peak negative voltage at REFH must not swing below REFL.

### Digital Interface

#### Serial Interface

Serial data at DIN is clocked in on the rising edge of CLK, while CS is low and SHDN is high (Figure 5). Data can be loaded at clock rates up to 6.25MHz (4MHz for MAX529). Logic inputs are CMOS and TTL compatible. The serial output DOUT is an open-drain N-channel FET that sinks up to 5mA and requires an external pull-up resistor (typically 4.7kΩ) to  $V_{DD}$ . Output data changes on the rising edge of CLK.

Any number of MAX528s or MAX529s can be daisy-chained by connecting the DOUT pin of one device (with pullup resistor) to the DIN pin of the following device in the chain. CLK and CS are bussed together. Clock period and  $t_{CSS0}$  (CS low to CLK high) must be increased to account for data delays between devices.



Figure 2. Simplified Full-Buffered Output Circuit

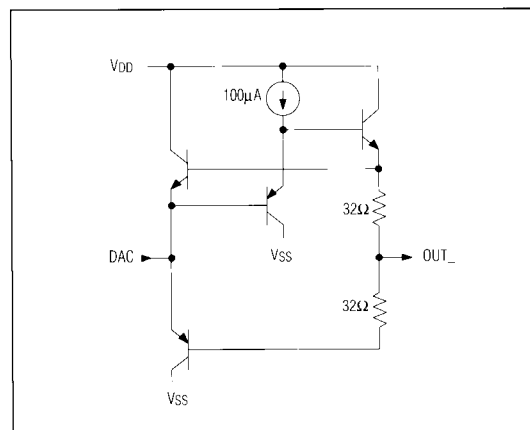

Figure 3. Simplified Half-Buffered Output Circuit

## Octal 8-Bit Serial DACs with Output Buffer



Figure 4. Using an AC Reference with the MAX528

If capacitive loading at the DOUT-to-DIN junction between two devices is 50pF or less, then the required  $t_{CSS0}$  becomes the sum of  $t_{DV}$  (enable) and  $t_{DS}$  (setup times), which is 130ns (90ns + 40ns) for MAX528 and  $t_{CSS0}$  170ns (120ns + 50ns) for the MAX529.

Maximum clock rate is influenced by pullup resistor size as well as capacitive loading:  $f_{CLKmax} = 1/(t_{DO} + t_{DS} + 0.65t_{RC})$ , where  $t_{DO} = 130ns$ ,  $t_{DS} = 40ns$ , and  $t_{RC}$  is the pullup resistor and capacitive load product. So for a 1k $\Omega$  pullup and 50pF load, the MAX528  $f_{CLKmax}$  is 4.7MHz; for a 4.7k $\Omega$  pullup with 50pF load,  $f_{CLKmax}$  drops to 2.8MHz. A similar calculation can be made for the MAX529, using  $t_{DO} = 200ns$ , and  $t_{DS} = 50ns$ .

### DAC Programming

The MAX528/MAX529 are programmed by 16 data bits in two 8-bit bytes, the address pointer bits (A7-A0) followed by the data byte (D7-D0). These bits enter a shift register serially through DIN: A7 first, and D0 last. The data exits DOUT 16 clock cycles later in the same order.

Data at DIN is shifted into the first register (while all 16 register bits shift forward one stage) on a rising CLK edge, while holding CS low and SHDN high. This must occur 16 times to load all data bits into the shift registers. On the rising edge of CS, data in the 16 shift registers is transferred as addressed and CLK is disabled.

There are three types of instructions: NOP, SET DAC, and set buffer modes.

### No Operation

No Operation (NOP) is implemented when all 8 address pointer bits (A7-A0) and data bit D7 are logic 0. Data in D6-D0 is ignored. When this instruction is clocked in, no registers are updated and the outputs remain unchanged. NOP is a place-saver when multiple MAX528/MAX529s are daisy-chained.

### SET DAC

SET DAC is implemented when at least one of the 8 address pointer bits (A7-A0) is logic 1. SET DAC updates the digital code of any or all DAC registers (and their corresponding DAC outputs) to a single new value. The new value is contained in the data byte (D7-D0). Each address pointer bit (A7-A0) selects a DAC output. Any combination of outputs can be updated simultaneously with one 16-bit instruction. Remember that address 0000 0000 is reserved for NOP and set buffer modes.

SET DAC does not change the buffer modes.

### Set Buffer Modes

Set buffer modes is implemented when all 8 address pointer bits (A7-A0) are logic 0 and data bit D7 is 1. (see Table 1). Data in D6 is ignored. When this instruction is issued, data bits D5-D0 are transferred to the mode registers only; the DAC registers are unchanged.

Enabling and disabling the 8 buffers is done in four pairs by data bits D1, D2, D4, and D5. D1 controls buffers 6 and 7, D2 controls buffers 4 and 5, D4 controls buffers 2 and 3, and D5 controls buffers 0 and 1. A logic 1 enables a buffer pair (full-buffered or half-buffered mode); a logic 0 disables a buffer pair (unbuffered mode).

Full-buffered and half-buffered modes are set by two data bits, D0 and D3. D0 controls OUT4 through OUT7; D3 controls OUT0 through OUT3. A logic 1 enables full-buffered mode; a logic 0 enables half-buffered mode. These data bits apply only when buffer output pairs are enabled by a 1 in D1, D2, D4, or D5.

The set buffer modes instruction does not update the DAC registers.

# Octal 8-Bit Serial DACs with Output Buffer

MAX528/MAX529

## Programming Data

**Table 2. Programming NOP**

Data Direction: First >-----> Last

| Function   | Address Pointer Bits |    |    |    |    |    |    |    | Data Byte |    |    |    |    |    |    |    |
|------------|----------------------|----|----|----|----|----|----|----|-----------|----|----|----|----|----|----|----|
|            | A7                   | A6 | A5 | A4 | A3 | A2 | A1 | A0 | D7        | D6 | D5 | D4 | D3 | D2 | D1 | D0 |
| <b>NOP</b> | 0                    | 0  | 0  | 0  | 0  | 0  | 0  | 0  | 0         | X  | X  | X  | X  | X  | X  | X  |

X = Don't Care

**Table 3. Programming SET DAC Outputs**

| Function               | Address Pointer Bits |    |    |    |    |    |    |    | Data Byte |    |    |    |    |    |    |    |
|------------------------|----------------------|----|----|----|----|----|----|----|-----------|----|----|----|----|----|----|----|
|                        | A7                   | A6 | A5 | A4 | A3 | A2 | A1 | A0 | D7        | D6 | D5 | D4 | D3 | D2 | D1 | D0 |
| <b>SET DAC Outputs</b> | A7                   | A6 | A5 | A4 | A3 | A2 | A1 | A0 | D7        | D6 | D5 | D4 | D3 | D2 | D1 | D0 |

DAC code: 0000 0000 to 1111 1111 (00 Hex through FF Hex) D7 = MSB; D0 = LSB.  
 AX = set DAC register X to digital value D7-D0. A7 = OUT7...A0 = OUT0. Logic 1 sets the DAC register to new DAC code in D7-D0.  
 logic 0 ignores D7-D0 code and keeps previous code. At least one of these 8 bits must be 1 (A7-A0 = 01 hex to FF hex).

**Table 4. Programming Set Buffer Modes**

| Function                | Address Pointer Bits |    |    |    |    |    |    |    | Data Byte |    |     |     |     |     |     |     |
|-------------------------|----------------------|----|----|----|----|----|----|----|-----------|----|-----|-----|-----|-----|-----|-----|
|                         | A7                   | A6 | A5 | A4 | A3 | A2 | A1 | A0 | D7        | D6 | D5  | D4  | D3  | D2  | D1  | D0  |
| <b>Set Buffer Modes</b> | 0                    | 0  | 0  | 0  | 0  | 0  | 0  | 0  | 1         | X  | 0&1 | 2&3 | 0/3 | 4&5 | 6&7 | 4/7 |

X = Don't Care (D6)  
 0&1 (D5) = buffer enable for OUT0 and OUT1. Logic 1 = buffers enabled, 0 = buffers disabled (unbuffered mode). Similar remarks apply to 2&3 (D4), 4&5 (D2), and 6&7 (D1).  
 0/3 (D3) = buffer modes for OUT0-3. Logic 1 = full-buffered mode, 0 = half-buffered mode. D3 has no meaning when D4 and D5 are both 0.  
 4/7 (D0) = buffer modes for OUT4-7. Logic 1 = full-buffered mode, 0 = half-buffered mode. D0 has no meaning when D1 and D2 are both 0.

## Programming Examples

**Example 1:** Set OUT0, OUT2, OUT7 to binary value 0100 1110 (4E hex). Leave OUT1, OUT3, OUT4, OUT5, and OUT6 unchanged, and leave buffer states unchanged.

Data Direction: First >-----> Last

|                  | A7 | A6 | A5 | A4 | A3 | A2 | A1 | A0 | D7 | D6 | D5 | D4 | D3 | D2 | D1 | D0 |
|------------------|----|----|----|----|----|----|----|----|----|----|----|----|----|----|----|----|
| <b>Example 1</b> | 1  | 0  | 0  | 0  | 0  | 1  | 0  | 1  | 0  | 1  | 0  | 0  | 1  | 1  | 1  | 0  |

**Example 2:** Set all DACs except OUT6 to binary value 0000 0000 (00 hex). Leave OUT6 unchanged, and leave buffer states unchanged.

|                  | A7 | A6 | A5 | A4 | A3 | A2 | A1 | A0 | D7 | D6 | D5 | D4 | D3 | D2 | D1 | D0 |
|------------------|----|----|----|----|----|----|----|----|----|----|----|----|----|----|----|----|
| <b>Example 2</b> | 1  | 0  | 1  | 1  | 1  | 1  | 1  | 1  | 0  | 0  | 0  | 0  | 0  | 0  | 0  | 0  |

**Example 3:** Disable all buffers (unbuffered mode). Leave DAC data unchanged.

|                  | A7 | A6 | A5 | A4 | A3 | A2 | A1 | A0 | D7 | D6 | D5 | D4 | D3 | D2 | D1 | D0 |
|------------------|----|----|----|----|----|----|----|----|----|----|----|----|----|----|----|----|
| <b>Example 3</b> | 0  | 0  | 0  | 0  | 0  | 0  | 0  | 0  | 1  | X  | 0  | 0  | X  | 0  | 0  | X  |

X = Don't Care

**Example 4:** (1) Enable OUT0 and OUT1 buffers in full-buffered mode; put OUT2 and OUT3 in unbuffered mode.  
 (2) Enable OUT6 and OUT7 buffers in half-buffered mode; put OUT4 and OUT5 in unbuffered mode. Leave DAC data unchanged.

|                  | A7 | A6 | A5 | A4 | A3 | A2 | A1 | A0 | D7 | D6 | D5 | D4 | D3 | D2 | D1 | D0 |
|------------------|----|----|----|----|----|----|----|----|----|----|----|----|----|----|----|----|
| <b>Example 4</b> | 0  | 0  | 0  | 0  | 0  | 0  | 0  | 0  | 1  | X  | 1  | 0  | 1  | 0  | 1  | 0  |

X = Don't Care



## Octal 8-Bit Serial DACs with Output Buffer



Figure 5. Timing Diagram

### Ordering Information (continued)

| PART      | TEMP. RANGE     | PIN-PACKAGE    |
|-----------|-----------------|----------------|
| MAX529CPP | 0°C to +70°C    | 20 Plastic DIP |
| MAX529CWG | 0°C to +70°C    | 24 Wide SO     |
| MAX529CAG | 0°C to +70°C    | 24 SSOP        |
| MAX529C/D | 0°C to +70°C    | Dice*          |
| MAX529EPP | -40°C to +85°C  | 20 Plastic DIP |
| MAX529EWG | -40°C to +85°C  | 24 Wide SO     |
| MAX529EAG | -40°C to +85°C  | 24 SSOP        |
| MAX529MJP | -55°C to +125°C | 20 CERDIP**    |

\* Contact factory for dice specifications.

\*\* Contact factory for availability and processing to MIL-STD-883.

### Functional Diagram



Maxim cannot assume responsibility for use of any circuitry other than circuitry entirely embodied in a Maxim product. No circuit patent licenses are implied. Maxim reserves the right to change the circuitry and specifications without notice at any time.

16 Maxim Integrated Products, 120 San Gabriel Drive, Sunnyvale, CA 94086 (408) 737-7600





## Стандарт Электрон Связь

Мы молодая и активно развивающаяся компания в области поставок электронных компонентов. Мы поставляем электронные компоненты отечественного и импортного производства напрямую от производителей и с крупнейших складов мира.

Благодаря сотрудничеству с мировыми поставщиками мы осуществляем комплексные и плановые поставки широчайшего спектра электронных компонентов.

Собственная эффективная логистика и склад в обеспечивает надежную поставку продукции в точно указанные сроки по всей России.

Мы осуществляем техническую поддержку нашим клиентам и предпродажную проверку качества продукции. На все поставляемые продукты мы предоставляем гарантию .

Осуществляем поставки продукции под контролем ВП МО РФ на предприятия военно-промышленного комплекса России , а также работаем в рамках 275 ФЗ с открытием отдельных счетов в уполномоченном банке. Система менеджмента качества компании соответствует требованиям ГОСТ ISO 9001.

Минимальные сроки поставки, гибкие цены, неограниченный ассортимент и индивидуальный подход к клиентам являются основой для выстраивания долгосрочного и эффективного сотрудничества с предприятиями радиоэлектронной промышленности, предприятиями ВПК и научно-исследовательскими институтами России.

С нами вы становитесь еще успешнее!

### Наши контакты:

**Телефон:** +7 812 627 14 35

**Электронная почта:** [sales@st-electron.ru](mailto:sales@st-electron.ru)

**Адрес:** 198099, Санкт-Петербург,  
Промышленная ул, дом № 19, литера Н,  
помещение 100-Н Офис 331