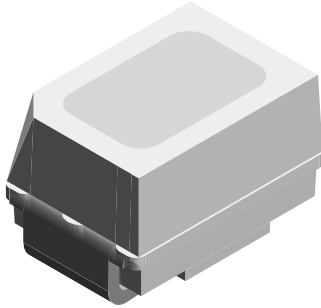


## Power Mini SMD LED



19226

### DESCRIPTION

The new MiniLED series has been designed in a small white SMT package. The feature of the device is the very small package 2.3 mm x 1.3 mm x 1.4 mm. The MiniLED is an obvious solution for small-scale, high-power products that are expected to work reliably in an arduous environment. This is often the case in automotive and industrial application.

### PRODUCT GROUP AND PACKAGE DATA

- Product group: LED
- Product series: power
- Package: SMD MiniLED
- Angle of half intensity:  $\pm 60^\circ$

### FEATURES

- Utilizing latest advanced AllnGaP technology
- Available in 8 mm tape
- Luminous intensity and color categorized per packing unit
- Luminous intensity ratio per packing unit  $I_{Vmax}/I_{Vmin.} \leq 1.6$
- ESD-withstand voltage: Up to 2 kV according to JESD22-A114-B
- Preconditioning according to JEDEC® level 2a
- IR reflow soldering
- AEC-Q101 qualified
- Material categorization: For definitions of compliance please see [www.vishay.com/doc?99912](http://www.vishay.com/doc?99912)

 AUTOMOTIVE  
GRADE

**RoHS**  
COMPLIANT  
HALOGEN  
**FREE**  
**GREEN**  
(5-2008)

### APPLICATIONS

- Traffic signals and signs
- Interior and exterior lighting
- Dashboard illumination
- Indicator and backlighting purposes for audio, video, LCDs switches, symbols, illuminated advertising etc.

### PARTS TABLE

PART	COLOR	LUMINOUS INTENSITY (mcd)			at I <sub>F</sub> (mA)	WAVELENGTH (nm)			at I <sub>F</sub> (mA)	FORWARD VOLTAGE (V)			at I <sub>F</sub> (mA)	TECHNOLOGY
		MIN.	TYP.	MAX.		MIN.	TYP.	MAX.		MIN.	TYP.	MAX.		
VLMS234V2BA-GS08	Super red	900	1400	2240	50	626	630	639	50	1.9	2.2	2.8	50	AllnGaP on Si
VLMR234ABCA-GS08	Red	1400	2000	3550	50	619	625	631	50	1.9	2.2	2.8	50	AllnGaP on Si
VLMK234ABCA-GS08	Amber	1400	2500	3550	50	611	616	622	50	1.9	2.25	2.8	50	AllnGaP on Si
VLMY234ABCA-GS08	Yellow	1400	2000	3550	50	583	589	594	50	1.9	2.3	2.8	50	AllnGaP on Si

### ABSOLUTE MAXIMUM RATINGS (T<sub>amb</sub> = 25 °C, unless otherwise specified) VLMS234.., VLMR234.., VLMK234.., VLMY234..

PARAMETER	TEST CONDITION	SYMBOL	VALUE	UNIT
Reverse voltage <sup>(1)</sup>	Short term application only	V <sub>R</sub>	5	V
DC Forward current	T <sub>amb</sub> ≤ 60 °C	I <sub>F</sub>	70	mA
Power dissipation		P <sub>V</sub>	200	mW
Junction temperature		T <sub>j</sub>	125	°C
Operating temperature range		T <sub>amb</sub>	-40 to +100	°C
Storage temperature range		T <sub>stg</sub>	-40 to +100	°C
Thermal resistance junction/ambient	Mounted on PC board (pad size > 16 mm <sup>2</sup> )	R <sub>thJA</sub>	325	K/W

#### Note

- <sup>(1)</sup> Driving the LED in reverse direction is suitable for a short term application only

**OPTICAL AND ELECTRICAL CHARACTERISTICS** ( $T_{amb} = 25\text{ }^{\circ}\text{C}$ , unless otherwise specified)  
**VLMS234.., SUPER RED**

PARAMETER	TEST CONDITION	PART	SYMBOL	MIN.	TYP.	MAX.	UNIT
Luminous intensity	$I_F = 50\text{ mA}$	VLMS234V2BA	$I_V$	900	1400	2240	mcd
Luminous flux/luminous intensity			$\phi_V/I_V$	-	3	-	mlm/mcd
Dominant wavelength	$I_F = 50\text{ mA}$		$\lambda_d$	626	630	639	nm
Peak wavelength	$I_F = 50\text{ mA}$		$\lambda_p$	-	639	-	nm
Spectral bandwidth at 50 % $I_{rel\ max.}$	$I_F = 50\text{ mA}$		$\Delta\lambda$	-	18	-	nm
Angle of half intensity	$I_F = 50\text{ mA}$		$\phi$	-	$\pm 60$	-	deg
Forward voltage	$I_F = 50\text{ mA}$		$V_F$	1.9	2.2	2.8	V
Reverse current	$V_R = 5\text{ V}$		$I_R$	-	0.01	10	$\mu\text{A}$

**OPTICAL AND ELECTRICAL CHARACTERISTICS** ( $T_{amb} = 25\text{ }^{\circ}\text{C}$ , unless otherwise specified)  
**VLMR234.., RED**

PARAMETER	TEST CONDITION	PART	SYMBOL	MIN.	TYP.	MAX.	UNIT
Luminous intensity	$I_F = 50\text{ mA}$	VLMR234ABCA	$I_V$	1400	2000	3550	mcd
Luminous flux/luminous intensity			$\phi_V/I_V$	-	3	-	mlm/mcd
Dominant wavelength	$I_F = 50\text{ mA}$		$\lambda_d$	619	625	631	nm
Peak wavelength	$I_F = 50\text{ mA}$		$\lambda_p$	-	632	-	nm
Spectral bandwidth at 50 % $I_{rel\ max.}$	$I_F = 50\text{ mA}$		$\Delta\lambda$	-	18	-	nm
Angle of half intensity	$I_F = 50\text{ mA}$		$\phi$	-	$\pm 60$	-	deg
Forward voltage	$I_F = 50\text{ mA}$		$V_F$	1.9	2.2	2.8	V
Reverse current	$V_R = 5\text{ V}$		$I_R$	-	0.01	10	$\mu\text{A}$

**OPTICAL AND ELECTRICAL CHARACTERISTICS** ( $T_{amb} = 25\text{ }^{\circ}\text{C}$ , unless otherwise specified)  
**VLMK234.., AMBER**

PARAMETER	TEST CONDITION	PART	SYMBOL	MIN.	TYP.	MAX.	UNIT
Luminous intensity	$I_F = 50\text{ mA}$	VLMK234ABCA	$I_V$	1400	2500	3550	mcd
Luminous flux/luminous intensity			$\phi_V/I_V$	-	3	-	mlm/mcd
Dominant wavelength	$I_F = 50\text{ mA}$		$\lambda_d$	611	616	622	nm
Peak wavelength	$I_F = 50\text{ mA}$		$\lambda_p$	-	622	-	nm
Spectral bandwidth at 50 % $I_{rel\ max.}$	$I_F = 50\text{ mA}$		$\Delta\lambda$	-	18	-	nm
Angle of half intensity	$I_F = 50\text{ mA}$		$\phi$	-	$\pm 60$	-	deg
Forward voltage	$I_F = 50\text{ mA}$		$V_F$	1.9	2.25	2.8	V
Reverse current	$V_R = 5\text{ V}$		$I_R$	-	0.01	10	$\mu\text{A}$

**OPTICAL AND ELECTRICAL CHARACTERISTICS** ( $T_{amb} = 25\text{ }^{\circ}\text{C}$ , unless otherwise specified)  
**VLMY234.., YELLOW**

PARAMETER	TEST CONDITION	PART	SYMBOL	MIN.	TYP.	MAX.	UNIT
Luminous intensity	$I_F = 50\text{ mA}$	VLMY234ABCA	$I_V$	1400	2000	3550	mcd
Luminous flux/luminous intensity			$\phi_V/I_V$	-	3	-	mlm/mcd
Dominant wavelength	$I_F = 50\text{ mA}$		$\lambda_d$	583	589	594	nm
Peak wavelength	$I_F = 50\text{ mA}$		$\lambda_p$	-	591	-	nm
Spectral bandwidth at 50 % $I_{rel\ max.}$	$I_F = 50\text{ mA}$		$\Delta\lambda$	-	17	-	nm
Angle of half intensity	$I_F = 50\text{ mA}$		$\phi$	-	$\pm 60$	-	deg
Forward voltage	$I_F = 50\text{ mA}$		$V_F$	1.9	2.3	2.8	V
Reverse current	$V_R = 5\text{ V}$		$I_R$	-	0.01	10	$\mu\text{A}$

COLOR CLASSIFICATION				
GROUP	DOMINANT WAVELENGTH (nm)			
	AMBER		YELLOW	
	MIN.	MAX.	MIN.	MAX.
1	611	618		
2	614	622	583	586
3			585	588
4			587	590
5			589	592
6			591	594

**Note**

- Wavelengths are tested at a current pulse duration of 25 ms.

LUMINOUS INTENSITY CLASSIFICATION		
GROUP	LUMINOUS INTENSITY (mcd)	
	MIN.	MAX.
STANDARD		
V2	900	1120
AA	1120	1400
AB	1400	1800
BA	1800	2240
BB	2400	2800
CA	2800	3550

CROSSING TABLE	
VISHAY	OSRAM
VLMS234V2BA	LS M67F-S2U2-1
VLMY234ABCA	LY M67F-T2V2-36

**Note**

- Luminous intensity is tested at a current pulse duration of 25 ms and an accuracy of  $\pm 11\%$ .  
The above type numbers represent the order groups which include only a few brightness groups. Only one group will be shipped on each reel (there will be no mixing of two groups on each reel).  
In order to ensure availability, single brightness groups will not be orderable.  
In a similar manner for colors where wavelength groups are measured and binned, single wavelength groups will be shipped on any one reel.  
In order to ensure availability, single wavelength groups will not be orderable.

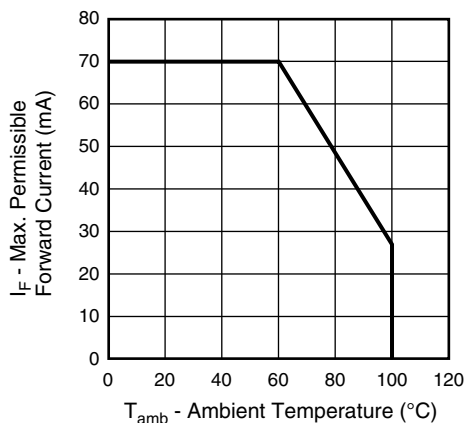
**TYPICAL CHARACTERISTICS** ( $T_{amb} = 25\text{ }^{\circ}\text{C}$ , unless otherwise specified)


Fig. 1 - Maximum Permissible Forward Current vs. Ambient Temperature

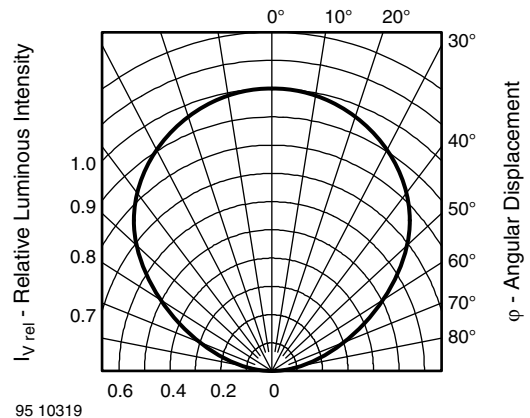


Fig. 2 - Relative Luminous Intensity vs. Angular Displacement

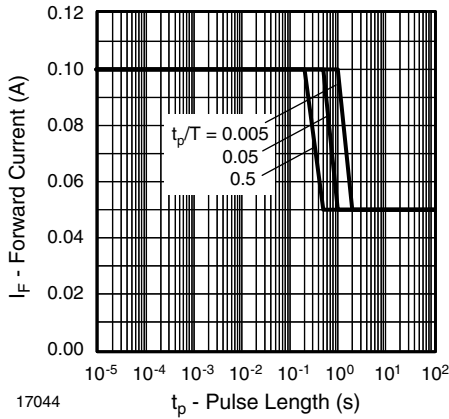


Fig. 3 - Forward Current vs. Pulse Length

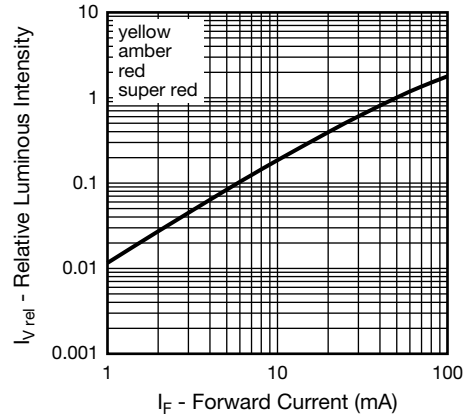


Fig. 6 - Relative Luminous Intensity vs. Forward Current

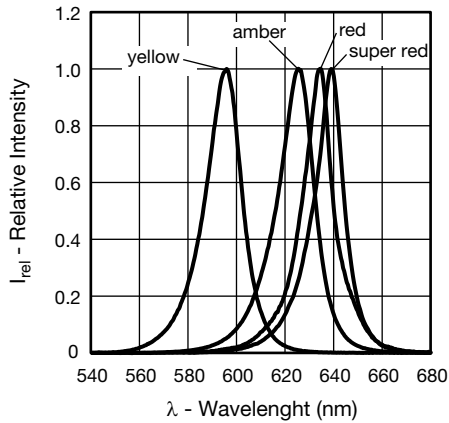


Fig. 4 - Relative Intensity vs. Wavelength

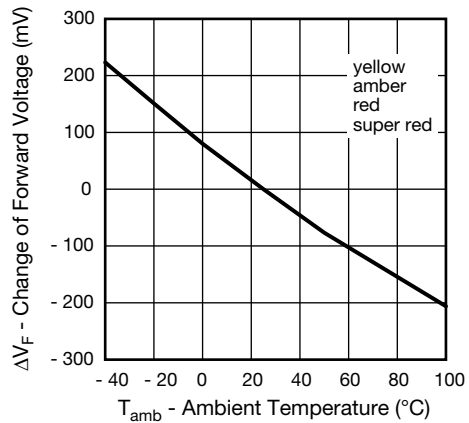


Fig. 7 - Change of Forward Voltage vs. Ambient Temperature

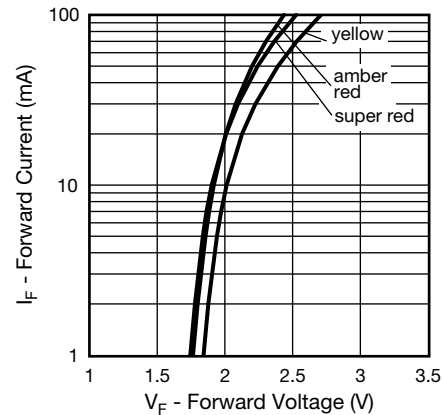


Fig. 5 - Forward Current vs. Forward Voltage

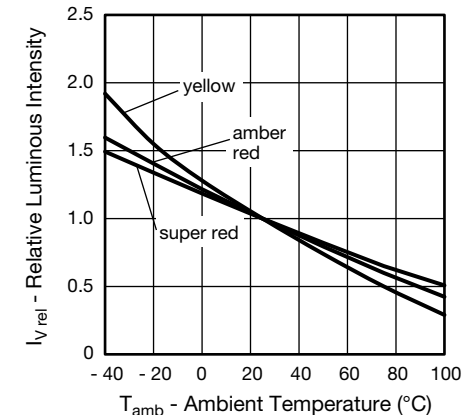


Fig. 8 - Relative Luminous Intensity vs. Ambient Temperature

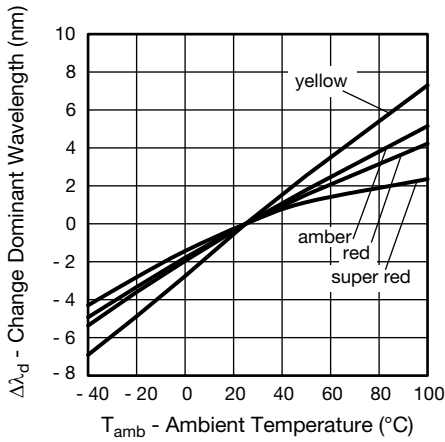
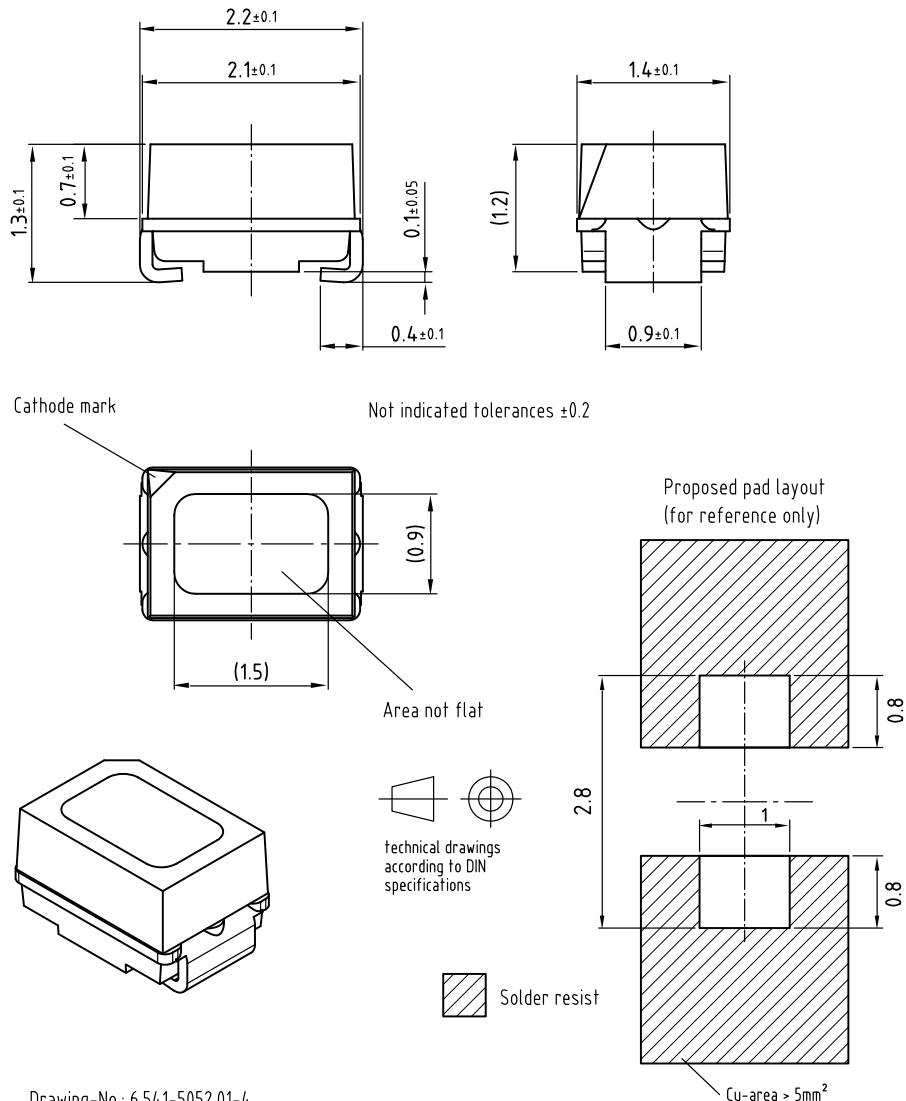


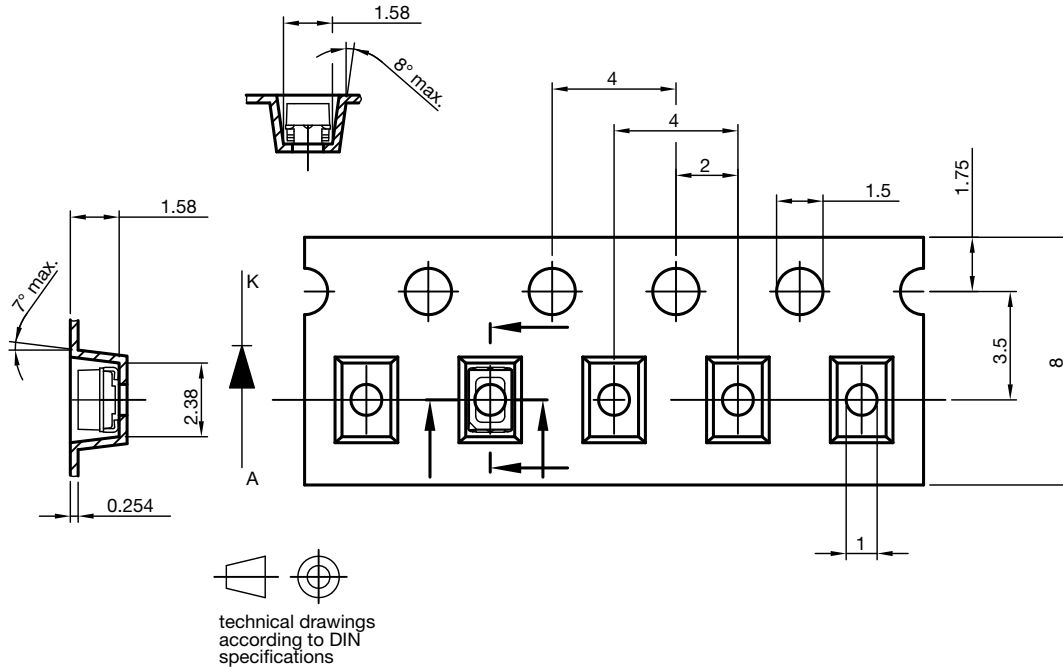
Fig. 9 - Change of Dominant Wavelength vs. Ambient Temperature

**PACKAGE DIMENSIONS** in millimeters



Drawing-No.: 6.541-5052.01-4  
 Issue: 3; 22.04.03  
 16892

**TAPE DIMENSIONS** in millimeters



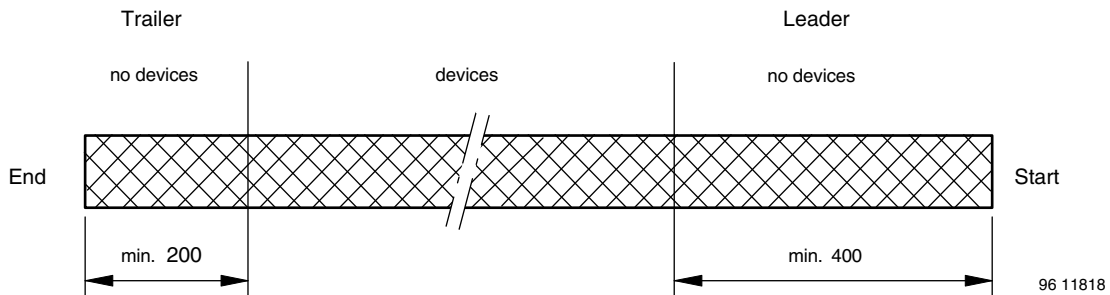
Drawing refers to following types: Mini SMD LED VLM. 233.

Drawing-No.: 9.700-5381.01-4

Issue: 1; 15.07.11

22585

**LEADER AND TRAILER DIMENSIONS** in millimeters



GS08 = 3000 pcs

**COVER TAPE PEEL STRENGTH**

According to DIN EN 60286-3

0.1 N to 1.3 N

300 ± 10 mm/min

165° to 180° peel angle

**LABEL**

**Standard bar code labels for finished goods**

The standard bar code labels are product labels and used for identification of goods. The finished goods are packed in final packing area. The standard packing units are labeled with standard bar code labels before transported as finished goods to warehouses. The labels are on each packing unit and contain Vishay Semiconductor GmbH specific data.

**SOLDERING PROFILE**

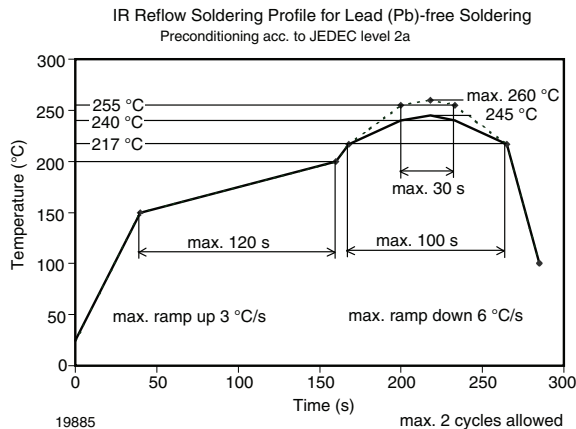
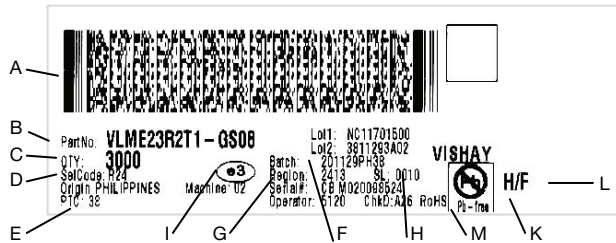


Fig. 10 - Vishay Lead (Pb)-free Reflow Soldering Profile (acc. to J-STD-020)

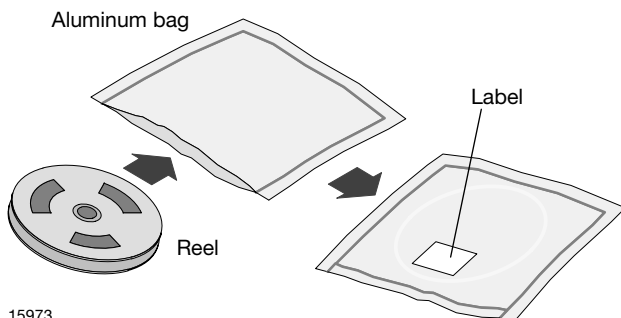
**BAR CODE PRODUCT LABEL (example)**



- A. 2D barcode
- B. PartNo = Vishay part number
- C. QTY = Quantity
- D. SelCode = selection code (binning)
- E. PTC = Code of manufacturing plant
- F. Batch = date code: year/week/plant code
- G. Region code
- H. SL = sales location
- I. Terminations finishing
- K. Lead (Pb)-free symbol
- L. Halogen-free symbol
- M. RoHS symbol

**DRY PACKING**

The reel is packed in an anti-humidity bag to protect the devices from absorbing moisture during transportation and storage.



15973

**FINAL PACKING**

The sealed reel is packed into a cardboard box. A secondary cardboard box is used for shipping purposes.

**RECOMMENDED METHOD OF STORAGE**

Dry box storage is recommended as soon as the aluminum bag has been opened to prevent moisture absorption. The following conditions should be observed, if dry boxes are not available:

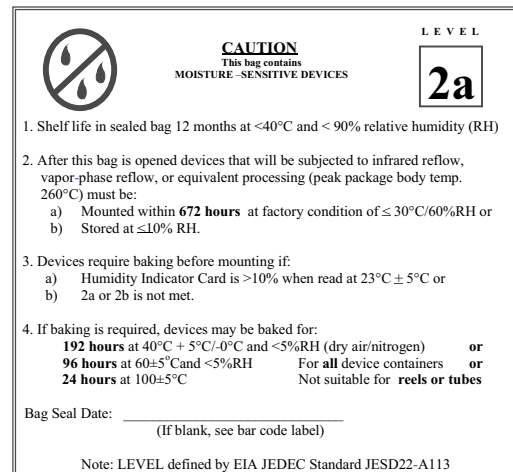
- Storage temperature 10 °C to 30 °C
- Storage humidity ≤ 60 % RH max.

After more than 672 h under these conditions moisture content will be too high for reflow soldering.

In case of moisture absorption, the devices will recover to the former condition by drying under the following condition:

- 192 h at 40 °C + 5 °C/- 0 °C and < 5 % RH (dry air/nitrogen) or
- 96 h at 60 °C + 5 °C and < 5 % RH for all device containers or
- 24 h at 100 °C + 5 °C not suitable for reel or tubes.

An EIA JEDEC standard JESD22-A112 level 2a label is included on all dry bags.



Example of JESD22-A112 level 2a label

**ESD PRECAUTION**

Proper storage and handling procedures should be followed to prevent ESD damage to the devices especially when they are removed from the antistatic shielding bag. Electrostatic sensitive devices warning labels are on the packaging.

**VISHAY SEMICONDUCTORS STANDARD BAR CODE LABEL**

The Vishay Semiconductors standard bar code labels are printed at final packing areas. The labels are on each packing unit and contain Vishay Semiconductors specific data.



## Disclaimer

ALL PRODUCT, PRODUCT SPECIFICATIONS AND DATA ARE SUBJECT TO CHANGE WITHOUT NOTICE TO IMPROVE RELIABILITY, FUNCTION OR DESIGN OR OTHERWISE.

Vishay Intertechnology, Inc., its affiliates, agents, and employees, and all persons acting on its or their behalf (collectively, "Vishay"), disclaim any and all liability for any errors, inaccuracies or incompleteness contained in any datasheet or in any other disclosure relating to any product.

Vishay makes no warranty, representation or guarantee regarding the suitability of the products for any particular purpose or the continuing production of any product. To the maximum extent permitted by applicable law, Vishay disclaims (i) any and all liability arising out of the application or use of any product, (ii) any and all liability, including without limitation special, consequential or incidental damages, and (iii) any and all implied warranties, including warranties of fitness for particular purpose, non-infringement and merchantability.

Statements regarding the suitability of products for certain types of applications are based on Vishay's knowledge of typical requirements that are often placed on Vishay products in generic applications. Such statements are not binding statements about the suitability of products for a particular application. It is the customer's responsibility to validate that a particular product with the properties described in the product specification is suitable for use in a particular application. Parameters provided in datasheets and/or specifications may vary in different applications and performance may vary over time. All operating parameters, including typical parameters, must be validated for each customer application by the customer's technical experts. Product specifications do not expand or otherwise modify Vishay's terms and conditions of purchase, including but not limited to the warranty expressed therein.

Except as expressly indicated in writing, Vishay products are not designed for use in medical, life-saving, or life-sustaining applications or for any other application in which the failure of the Vishay product could result in personal injury or death. Customers using or selling Vishay products not expressly indicated for use in such applications do so at their own risk. Please contact authorized Vishay personnel to obtain written terms and conditions regarding products designed for such applications.

No license, express or implied, by estoppel or otherwise, to any intellectual property rights is granted by this document or by any conduct of Vishay. Product names and markings noted herein may be trademarks of their respective owners.

## Material Category Policy

**Vishay Intertechnology, Inc. hereby certifies that all its products that are identified as RoHS-Compliant fulfill the definitions and restrictions defined under Directive 2011/65/EU of The European Parliament and of the Council of June 8, 2011 on the restriction of the use of certain hazardous substances in electrical and electronic equipment (EEE) - recast, unless otherwise specified as non-compliant.**

**Please note that some Vishay documentation may still make reference to RoHS Directive 2002/95/EC. We confirm that all the products identified as being compliant to Directive 2002/95/EC conform to Directive 2011/65/EU.**

**Vishay Intertechnology, Inc. hereby certifies that all its products that are identified as Halogen-Free follow Halogen-Free requirements as per JEDEC JS709A standards. Please note that some Vishay documentation may still make reference to the IEC 61249-2-21 definition. We confirm that all the products identified as being compliant to IEC 61249-2-21 conform to JEDEC JS709A standards.**





## Стандарт Электрон Связь

Мы молодая и активно развивающаяся компания в области поставок электронных компонентов. Мы поставляем электронные компоненты отечественного и импортного производства напрямую от производителей и с крупнейших складов мира.

Благодаря сотрудничеству с мировыми поставщиками мы осуществляем комплексные и плановые поставки широчайшего спектра электронных компонентов.

Собственная эффективная логистика и склад в обеспечивает надежную поставку продукции в точно указанные сроки по всей России.

Мы осуществляем техническую поддержку нашим клиентам и предпродажную проверку качества продукции. На все поставляемые продукты мы предоставляем гарантию .

Осуществляем поставки продукции под контролем ВП МО РФ на предприятия военно-промышленного комплекса России , а также работаем в рамках 275 ФЗ с открытием отдельных счетов в уполномоченном банке. Система менеджмента качества компании соответствует требованиям ГОСТ ISO 9001.

Минимальные сроки поставки, гибкие цены, неограниченный ассортимент и индивидуальный подход к клиентам являются основой для выстраивания долгосрочного и эффективного сотрудничества с предприятиями радиоэлектронной промышленности, предприятиями ВПК и научно-исследовательскими институтами России.

С нами вы становитесь еще успешнее!

### Наши контакты:

**Телефон:** +7 812 627 14 35

**Электронная почта:** [sales@st-electron.ru](mailto:sales@st-electron.ru)

**Адрес:** 198099, Санкт-Петербург,  
Промышленная ул, дом № 19, литера Н,  
помещение 100-Н Офис 331