

# KB CSLNM1.14

## OSRAM OSTAR® Projection Compact

Compact light source with isolated heat sink for improved heat dissipation and high current chip technology for increased light output.



### Applications

- Head-Up Display LED & Laser
- Projection Home LED & Laser

### Features:

- Package: white molded SMD ceramic package
- Chip technology: UX:3
- Typ. Radiation: 120° (Lambertian emitter)
- Color:  $\lambda_{\text{dom}} = 455 \text{ nm}$  (● blue)
- Corrosion Robustness Class: 3A
- ESD: 8 kV acc. to ANSI/ESDA/JEDEC JS-001 (HBM, Class 3B)

---

## Ordering Information

Type	Total radiant flux <sup>1)</sup> $I_F = 1000 \text{ mA}$ $\Phi_E$	Ordering Code
KB CSLNM1.14-3V6A-46	900 ... 1400 mW	Q65112A3602
KB CSLNM1.14-5A8A-23	1120 ... 1800 mW	Q65113A1588

## Maximum Ratings

Parameter	Symbol		Values
Surge Current			
Operating Temperature	$T_{op}$	min.	-40 °C
		max.	125 °C
Storage Temperature	$T_{stg}$	min.	-40 °C
		max.	125 °C
Junction Temperature	$T_j$	max.	150 °C
Forward current $T_s = 25\text{ °C}$	$I_F$	min.	40 mA
		max.	3000 mA
Forward current pulsed $D = 0.5 ; T_s = 25\text{ °C}$	$I_{F\ pulse}$	max.	4000 mA
ESD withstand voltage acc. to ANSI/ESDA/JEDEC JS-001 (HBM, Class 3B)	$V_{ESD}$		8 kV

## Characteristics

$I_F = 1000 \text{ mA}$ ;  $T_S = 25 \text{ °C}$

Parameter	Symbol		Values
Peak Wavelength	$\lambda_{\text{peak}}$	typ.	450 nm
Dominant Wavelength <sup>2)</sup> $I_F = 1000 \text{ mA}$	$\lambda_{\text{dom}}$	min. typ. max.	445 nm 455 nm 465 nm
Viewing angle at 50% $I_V$	$2\phi$	typ.	120 °
Radiating surface	$A_{\text{color}}$	typ.	1 x 1 mm <sup>2</sup>
Partial Flux acc. CIE 127:2007	$\Phi_{E/V, 120^\circ}$	typ.	0.76
Forward Voltage <sup>3)</sup> $I_F = 1000 \text{ mA}$	$V_F$	min. typ. max.	2.75 V 3.00 V 3.50 V
Real thermal resistance junction/solderpoint <sup>4)</sup>	$R_{\text{thJS real}}$	typ. max.	4.1 K / W 4.9 K / W
Electrical thermal resistance junction/solderpoint <sup>4)</sup> with efficiency $\eta_e = 33 \%$	$R_{\text{thJS elec.}}$	typ. max.	2.7 K / W 3.3 K / W

## Brightness Groups

Group	Total radiant flux <sup>1)</sup> $I_F = 1000 \text{ mA}$ min. $\Phi_E$	Total radiant flux <sup>1)</sup> $I_F = 1000 \text{ mA}$ max. $\Phi_E$
3V	900 mW	1000 mW
4V	1000 mW	1120 mW
5A	1120 mW	1250 mW
6A	1250 mW	1400 mW
7A	1400 mW	1590 mW
8A	1590 mW	1800 mW

## Wavelength Groups

Group	Dominant Wavelength <sup>2)</sup> $I_F = 1000 \text{ mA}$ min. $\lambda_{\text{dom}}$	Dominant Wavelength <sup>2)</sup> $I_F = 1000 \text{ mA}$ max. $\lambda_{\text{dom}}$
2	445 nm	449 nm
3	449 nm	453 nm
4	453 nm	457 nm
5	457 nm	461 nm
6	461 nm	465 nm

## Group Name on Label

### Example: 3V-2

Brightness	Wavelength
3V	2

### Relative Spectral Emission <sup>5)</sup>

$\Phi_{rel} = f(\lambda); I_F = 1000 \text{ mA}; T_J = 25 \text{ }^\circ\text{C}$

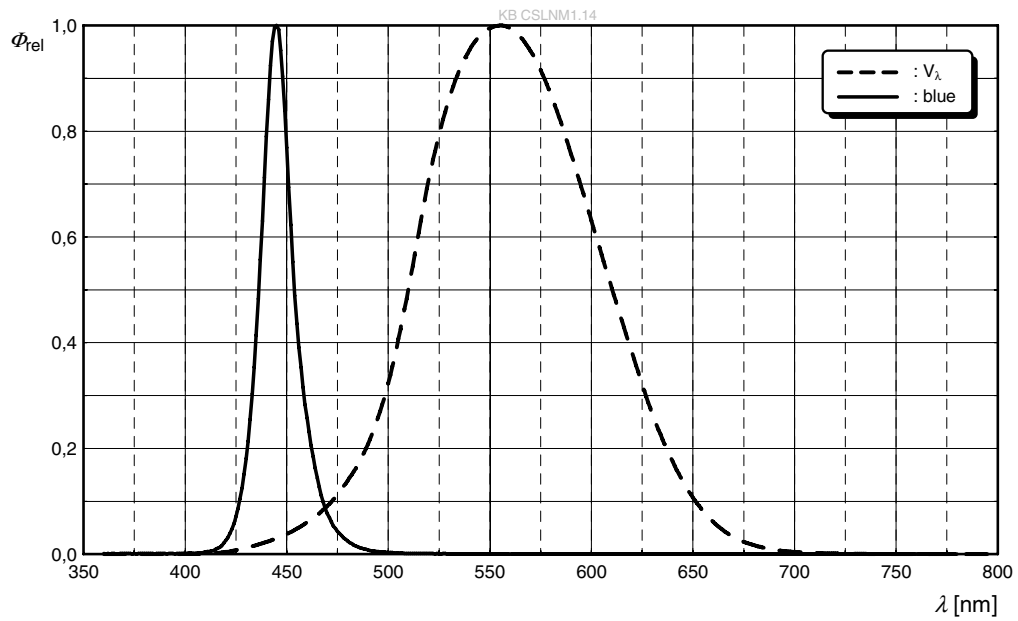

### Radiation Characteristics <sup>5)</sup>

$I_{rel} = f(\phi); T_J = 25 \text{ }^\circ\text{C}$

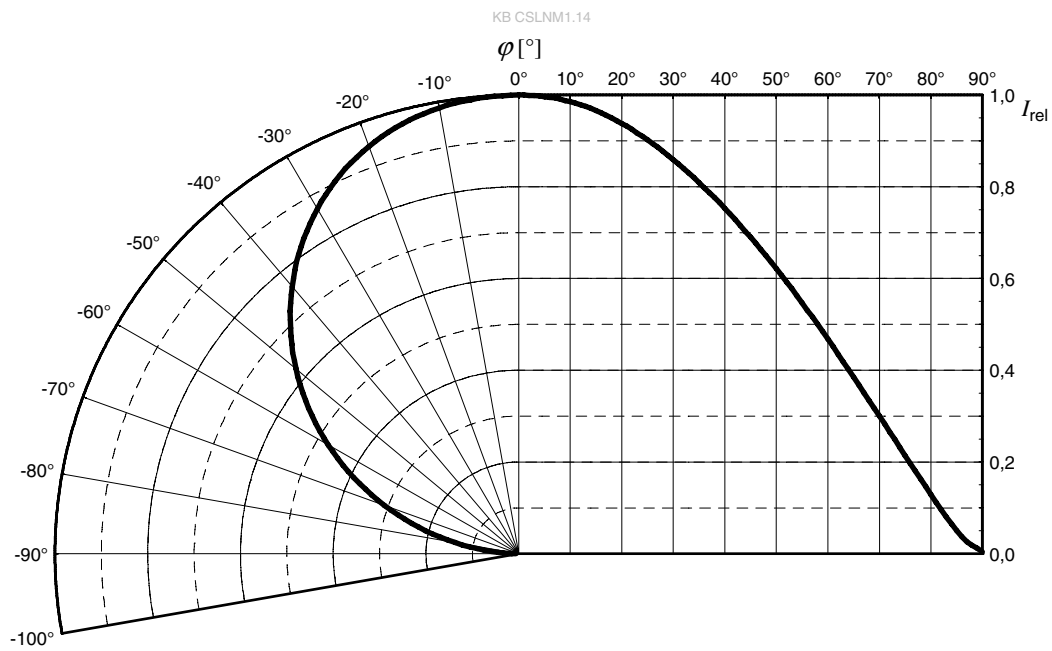

**Relative Partial Flux** <sup>5)</sup>

$$\Phi_E(2\varphi)/\Phi_E(180^\circ) = f(\varphi); T_j = 25\text{ }^\circ\text{C}$$

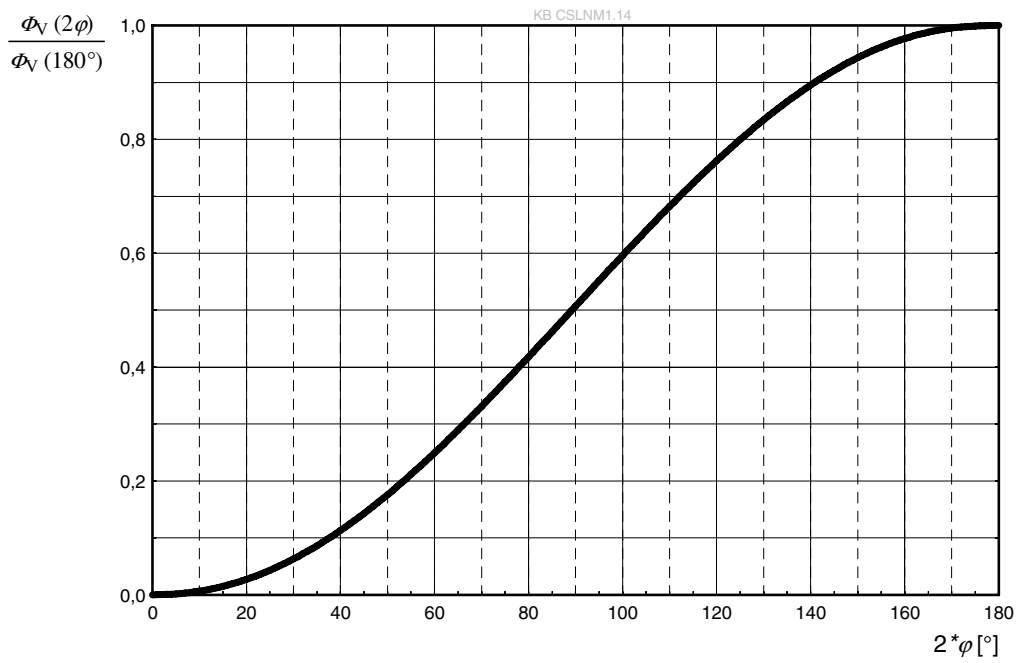

**Forward current** 5), 6)

$I_F = f(V_F); T_J = 25\text{ }^\circ\text{C}$

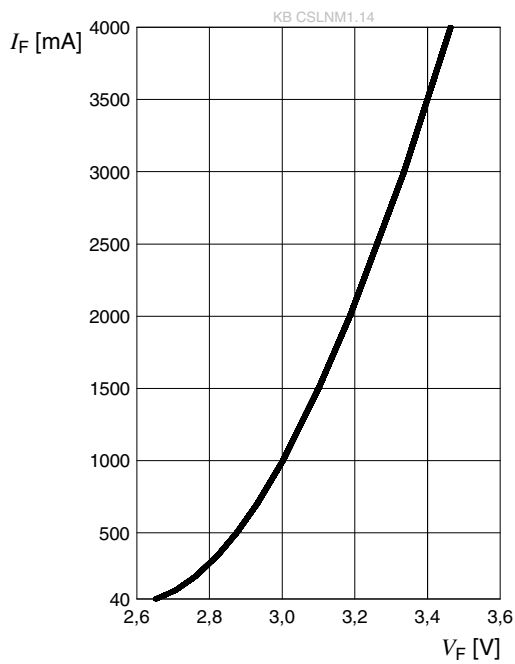

**Relative Radiant Power** 5), 6)

$\Phi_E / \Phi_E(1000\text{ mA}) = f(I_F); T_J = 25\text{ }^\circ\text{C}$

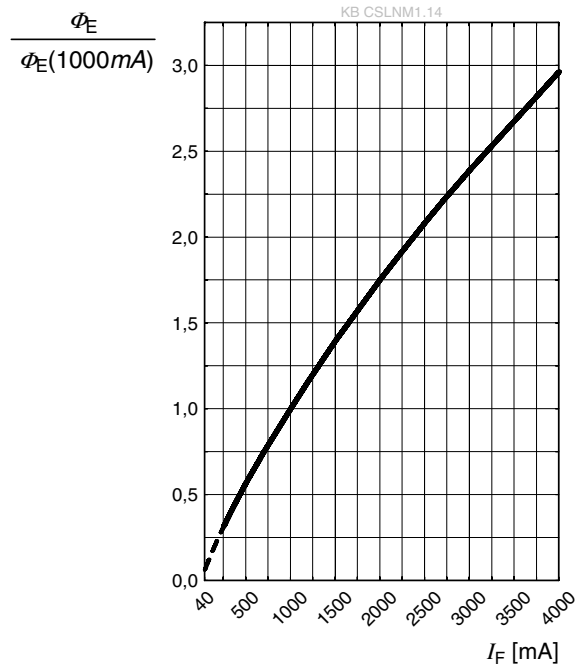

**Dominant Wavelength** 5)

$\Delta\lambda_{\text{dom}} = f(I_F); T_J = 25\text{ }^\circ\text{C}$

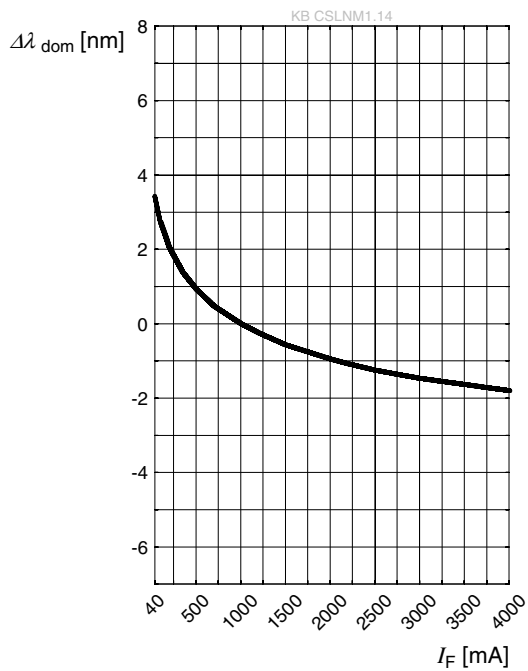



### Forward Voltage <sup>5)</sup>

$$\Delta V_F = V_F - V_F(25\text{ °C}) = f(T_j); I_F = 1000\text{ mA}$$

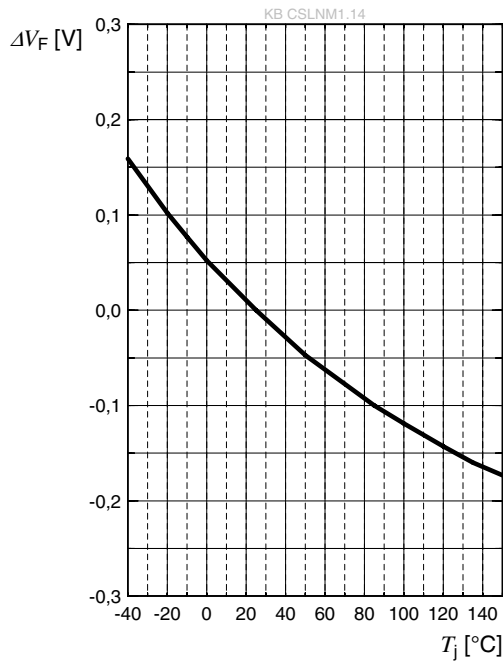

### Relative Radiant Power <sup>5)</sup>

$$\Phi_E / \Phi_E(25\text{ °C}) = f(T_j); I_F = 1000\text{ mA}$$

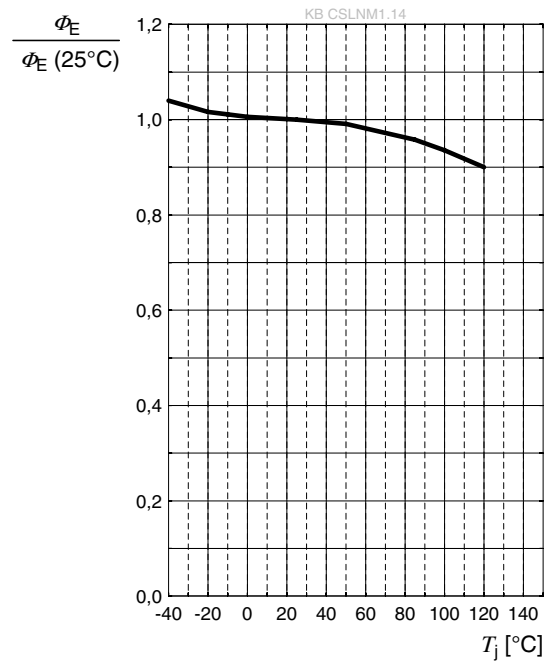

### Dominant Wavelength <sup>5)</sup>

$$\Delta \lambda_{\text{dom}} = \lambda_{\text{dom}} - \lambda_{\text{dom}}(25\text{ °C}) = f(T_j); I_F = 1000\text{ mA}$$

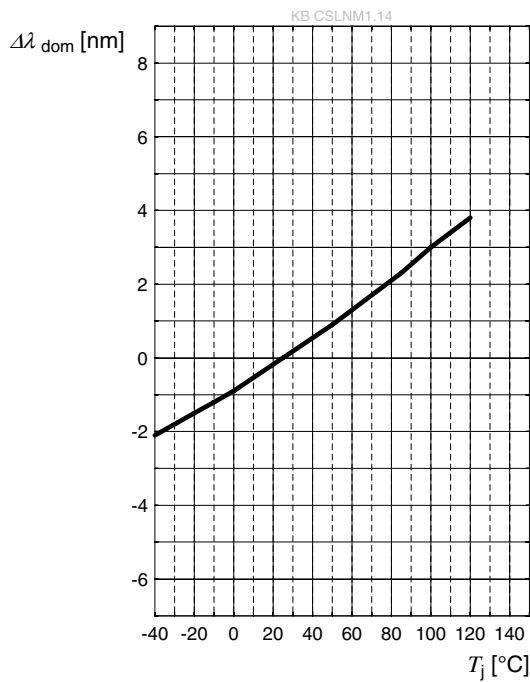

### Max. Permissible Forward Current

$I_F = f(T)$

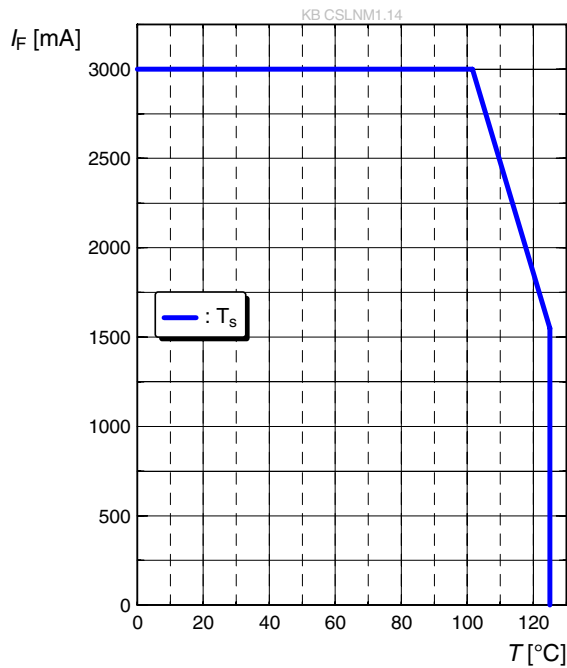

### Permissible Pulse Handling Capability

$I_F = f(t_p)$ ; D: Duty cycle

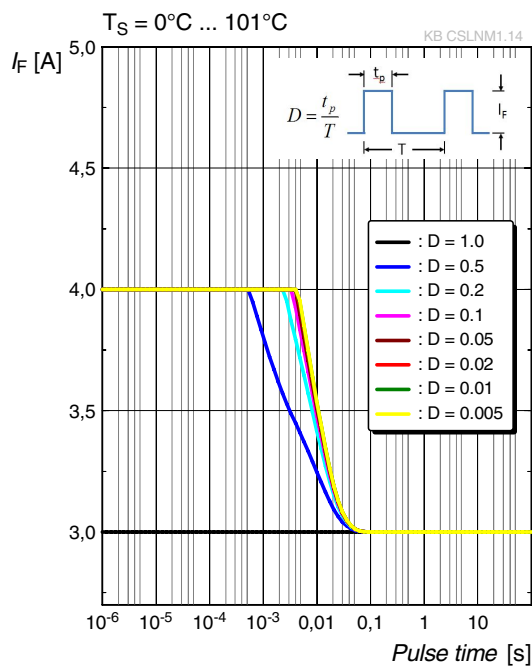

### Permissible Pulse Handling Capability

$I_F = f(t_p)$ ; D: Duty cycle

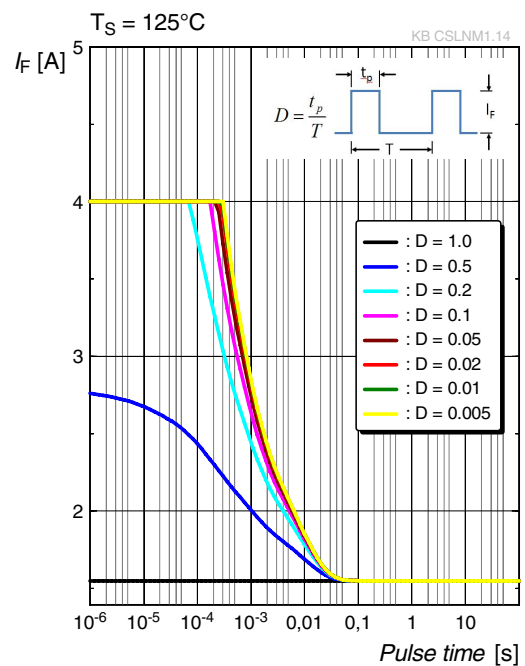

### Permissible F. Handling Capability

f: Frequency

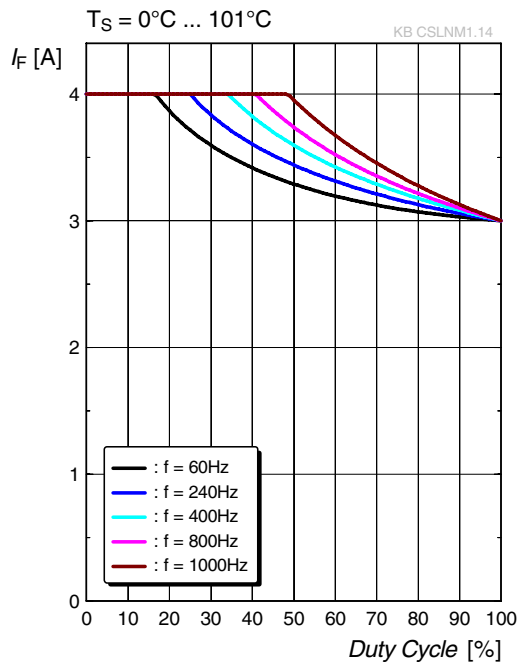

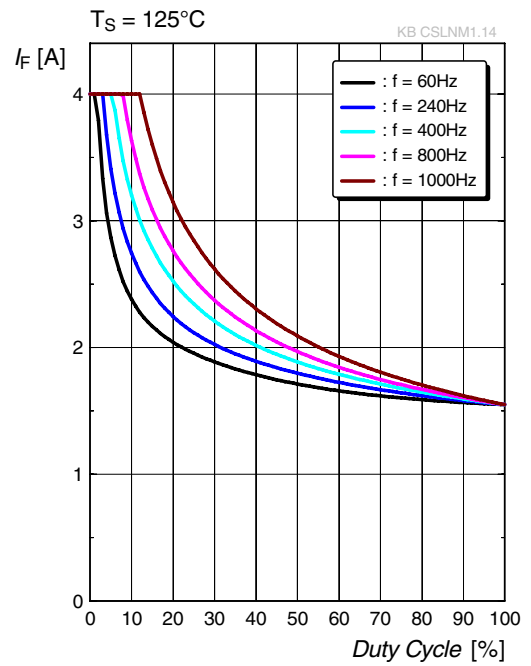

### Permissible F. Handling Capability

f: Frequency

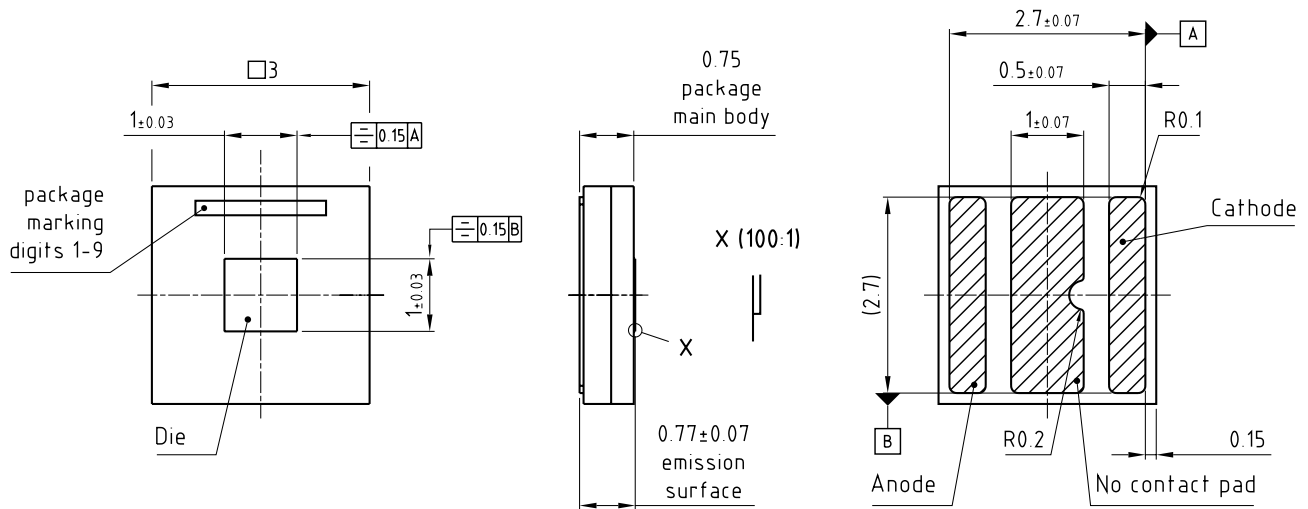

## Dimensional Drawing <sup>7)</sup>



general tolerance  $\pm 0.1$   
lead finish Au 

C63062-A4 312-A3 -04

### Further Information:

**Approximate Weight:** 36.0 mg

**Package marking:** Cathode

**Corrosion test:** Class: 3A

Test condition:  $40^{\circ}\text{C}$  / 90 % RH / 15 ppm  $\text{H}_2\text{S}$  / 14 days (stricter than IEC 60068-2-43)

Electrical Internal Circuit

# ESD Protection

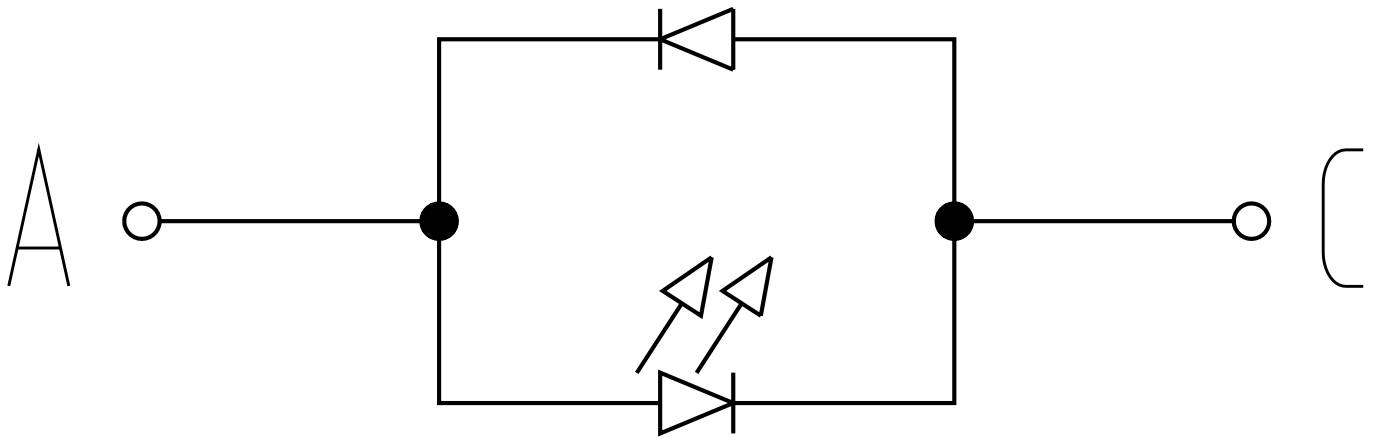

Recommended Solder Pad <sup>7)</sup>

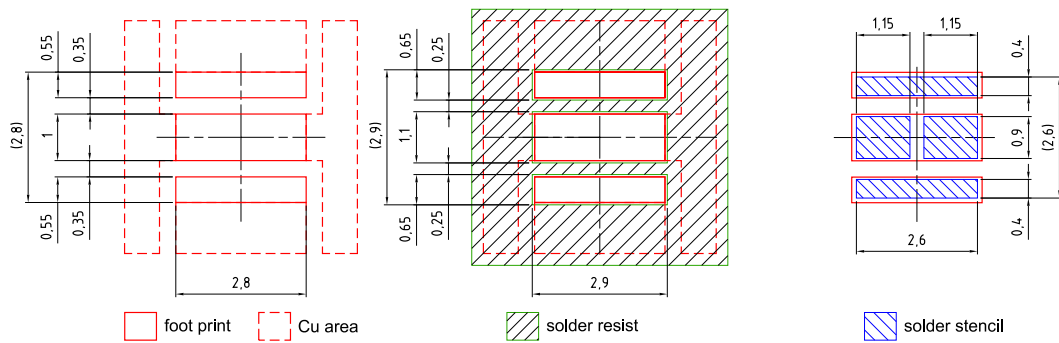

Component Location on Pad

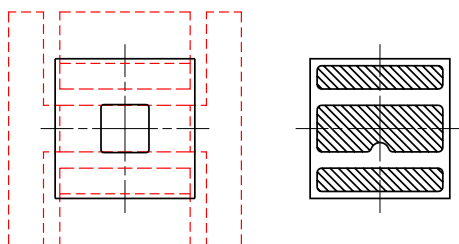

board material selection has high impact on system reliability

E062.3010.208 -02

## Recommended Solder Pad 7)

Alternative Solder pad design for pedestal MCPCB

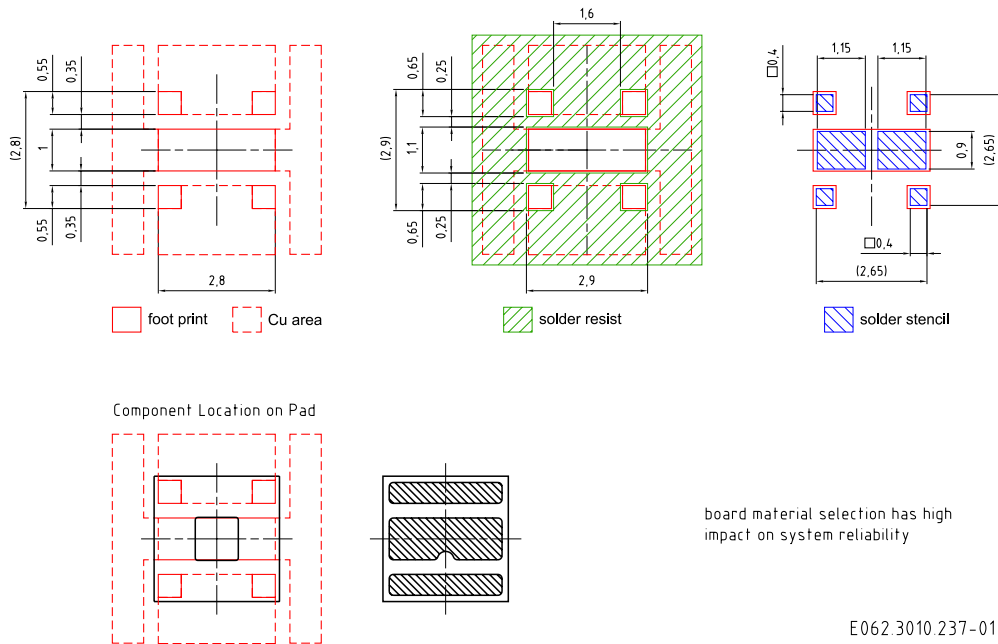

E062.3010.237-01

For superior solder joint connectivity results we recommend soldering under standard nitrogen atmosphere. Package not suitable for any kind of wet cleaning or ultrasonic cleaning.

## Reflow Soldering Profile

Product complies to MSL Level 2 acc. to JEDEC J-STD-020E

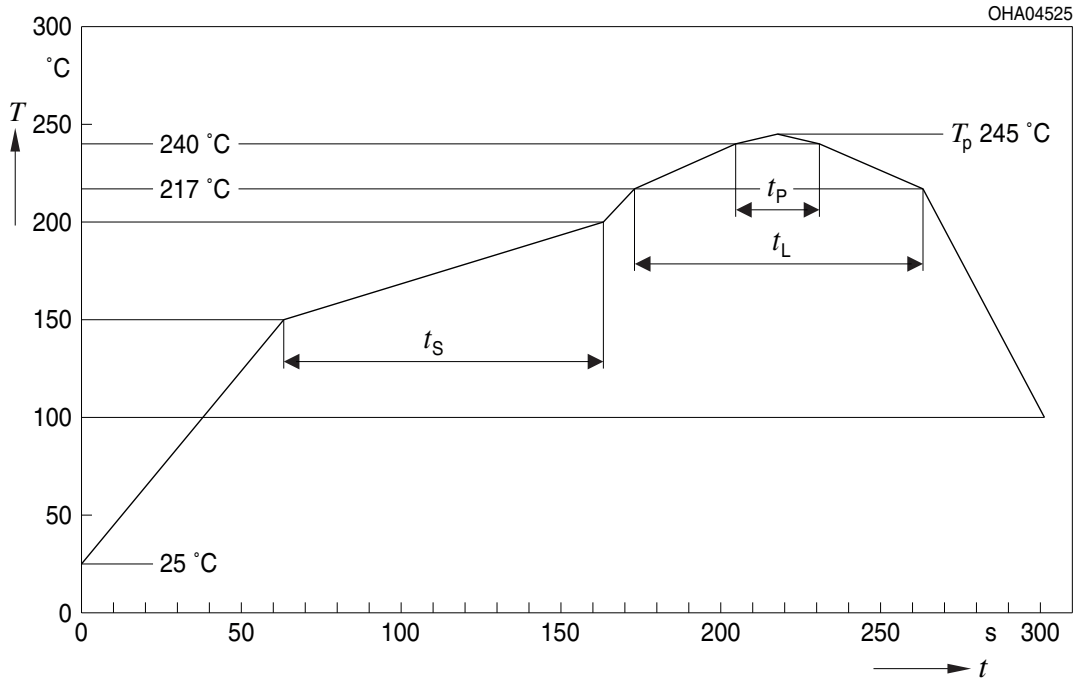

Profile Feature	Symbol	Pb-Free (SnAgCu) Assembly			Unit
		Minimum	Recommendation	Maximum	
Ramp-up rate to preheat <sup>*)</sup> 25 °C to 150 °C			2	3	K/s
Time $t_s$ $T_{Smin}$ to $T_{Smax}$	$t_s$	60	100	120	s
Ramp-up rate to peak <sup>*)</sup> $T_{Smax}$ to $T_p$			2	3	K/s
Liquidus temperature	$T_L$		217		°C
Time above liquidus temperature	$t_L$		80	100	s
Peak temperature	$T_p$		245	260	°C
Time within 5 °C of the specified peak temperature $T_p - 5$ K	$t_p$	10	20	30	s
Ramp-down rate* $T_p$ to 100 °C			3	6	K/s
Time 25 °C to $T_p$				480	s

All temperatures refer to the center of the package, measured on the top of the component  
 \*) slope calculation  $DT/Dt$ :  $Dt$  max. 5 s; fulfillment for the whole T-range

**Taping** <sup>7)</sup>

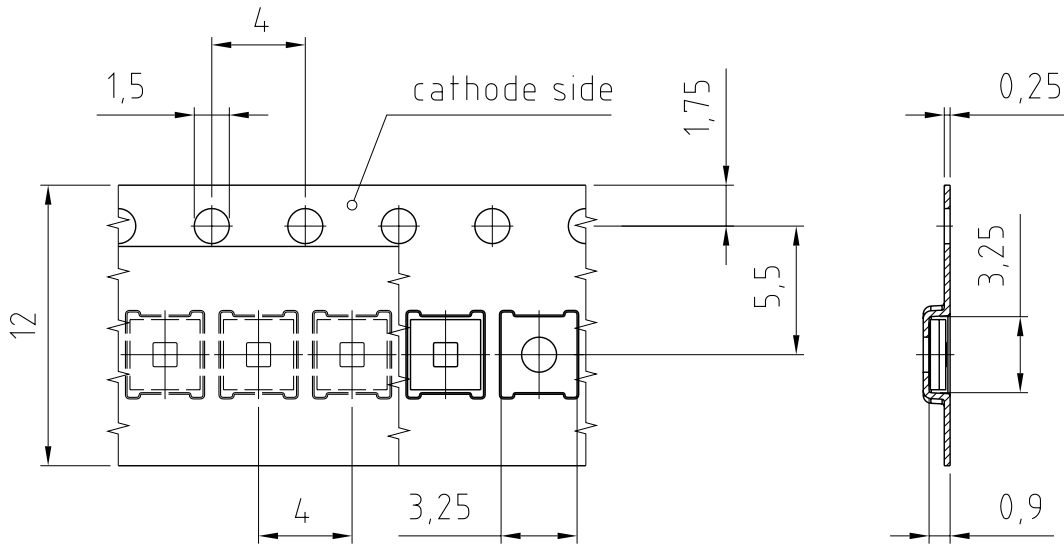

C63062-A4312-B3-03



**Tape and Reel** <sup>8)</sup>



**Reel Dimensions**

A	W	N <sub>min</sub>	W <sub>1</sub>	W <sub>2max</sub>	Pieces per PU
180 mm	12 + 0.3 / - 0.1 mm	60 mm	12.4 + 2 mm	18.4 mm	1000

### Barcode-Product-Label (BPL)

**OSRAM Opto Semiconductors** LX XXXX BIN1: XX-XX-X-XXX-X

RoHS Compliant

(6P) BATCH NO: 1234567890

(1T) LOT NO: 1234567890 (9D) D/C: 1234

(X) PROD NO: 123456789(Q)QTY: 9999 (G) GROUP: XX-XX-X-X

ML Temp ST  
X XXX °C X

Pack: RXX  
DEMY XXX  
X\_X123\_1234.1234 X

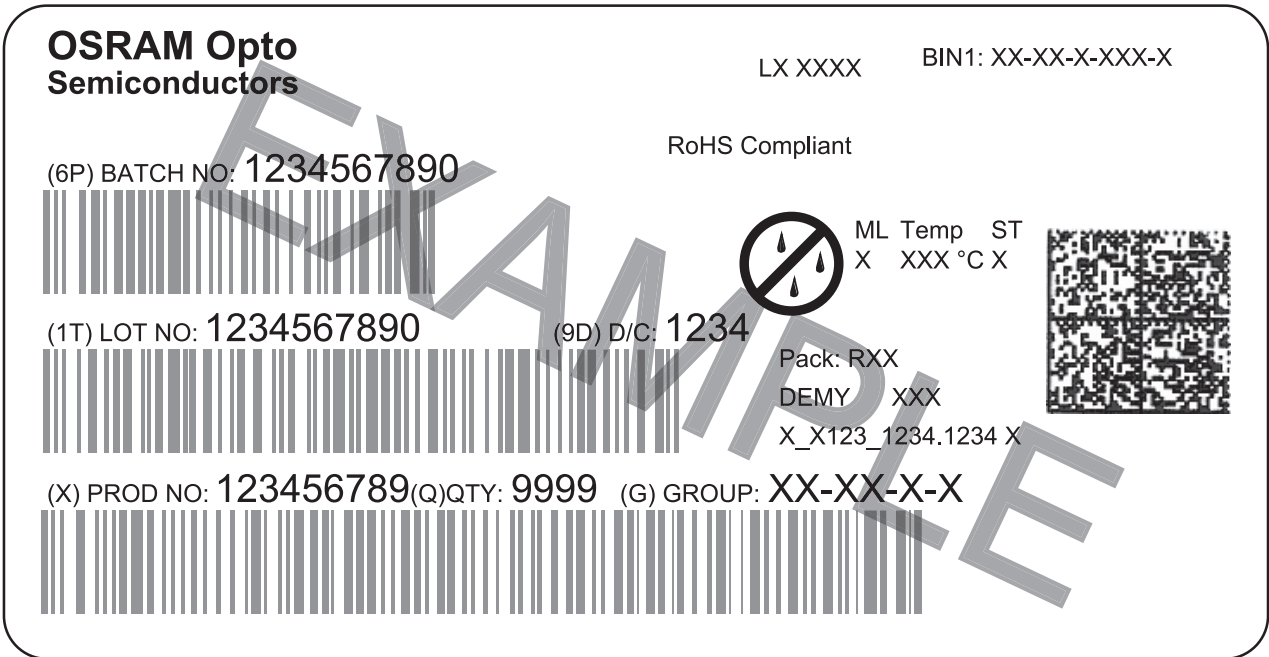

The diagram shows a rectangular label with rounded corners. It contains the OSRAM logo and company name at the top left. To the right are fields for 'LX XXXX' and 'BIN1: XX-XX-X-XXX-X'. Below the logo is the text 'RoHS Compliant'. The label features three horizontal barcode sections. The first is labeled '(6P) BATCH NO: 1234567890'. The second is labeled '(1T) LOT NO: 1234567890' and '(9D) D/C: 1234'. The third is labeled '(X) PROD NO: 123456789(Q)QTY: 9999' and '(G) GROUP: XX-XX-X-X'. To the right of the second barcode is a circular icon with a crossed-out rain cloud and the text 'ML Temp ST X XXX °C X'. Below this icon is the text 'Pack: RXX', 'DEMY XXX', and 'X\_X123\_1234.1234 X'. A square QR code is located on the right side of the label.

OHA04563

### Dry Packing Process and Materials <sup>7)</sup>

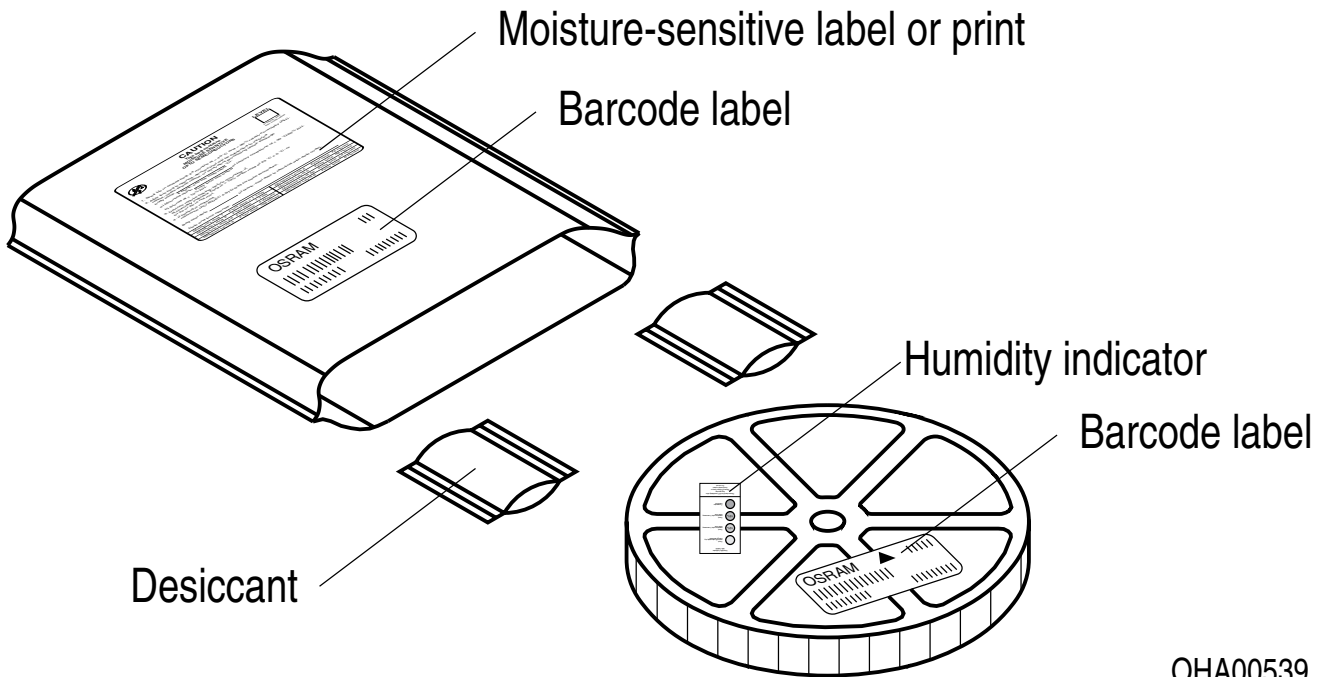

OHA00539

Moisture-sensitive product is packed in a dry bag containing desiccant and a humidity card according JEDEC-STD-033.

## Type Designation System

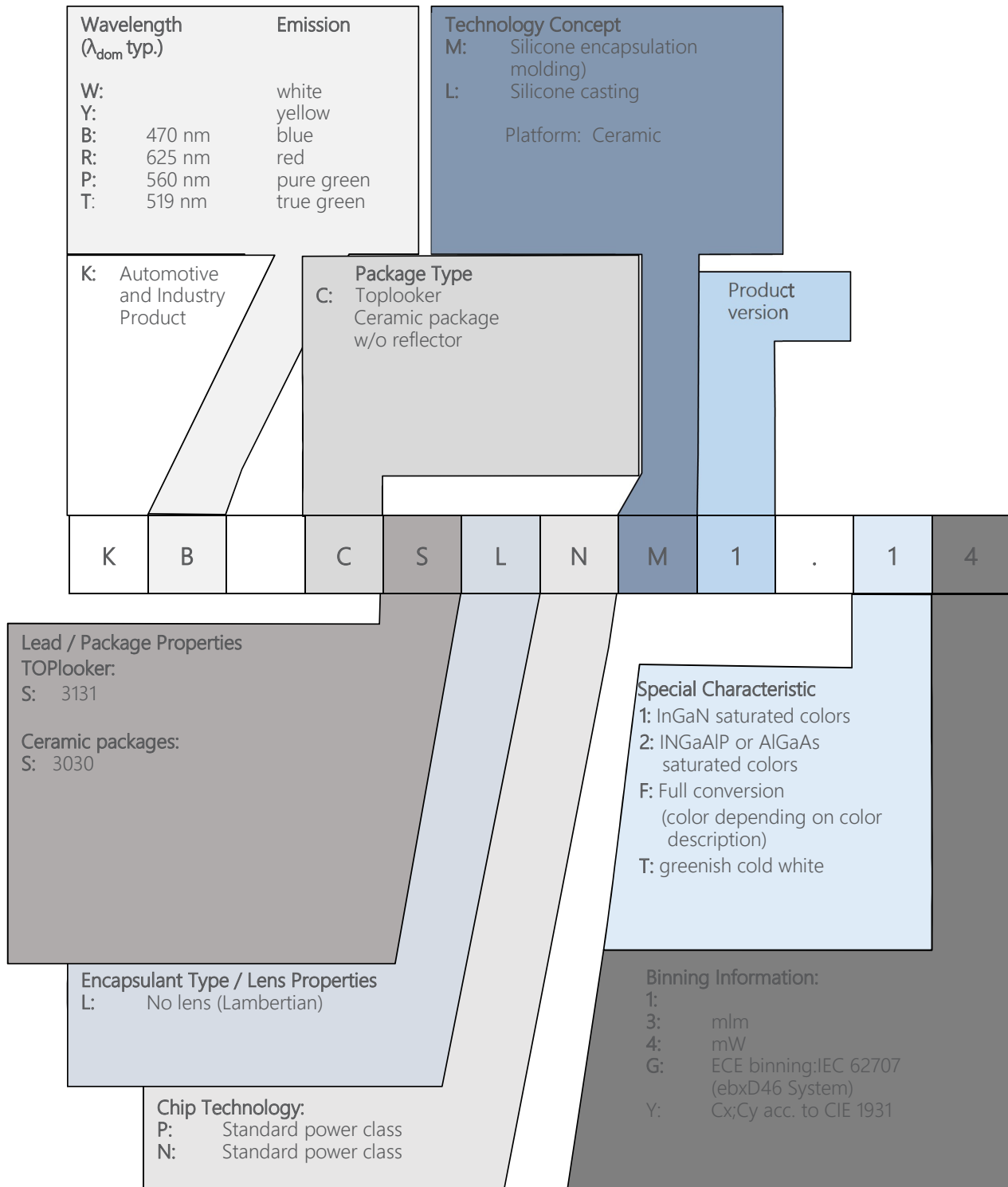

## Notes

The evaluation of eye safety occurs according to the standard IEC 62471:2006 (photo biological safety of lamps and lamp systems). Within the risk grouping system of this IEC standard, the device specified in this data sheet falls into the class **moderate risk (exposure time 0.25 s)**. Under real circumstances (for exposure time, conditions of the eye pupils, observation distance), it is assumed that no endangerment to the eye exists from these devices. As a matter of principle, however, it should be mentioned that intense light sources have a high secondary exposure potential due to their blinding effect. When looking at bright light sources (e.g. headlights), temporary reduction in visual acuity and afterimages can occur, leading to irritation, annoyance, visual impairment, and even accidents, depending on the situation.

Subcomponents of this device contain, in addition to other substances, metal filled materials. Metal filled materials can be affected by environments that contain traces of aggressive substances. Therefore, we recommend that customers avoid device exposure to aggressive substances during storage, production, and use.

For further application related information please visit [www.osram-os.com/appnotes](http://www.osram-os.com/appnotes)

## Disclaimer

### **Attention please!**

The information describes the type of component and shall not be considered as assured characteristics. Terms of delivery and rights to change design reserved. Due to technical requirements components may contain dangerous substances.

For information on the types in question please contact our Sales Organization.

If printed or downloaded, please find the latest version on the OSRAM OS website.

### **Packing**

Please use the recycling operators known to you. We can also help you – get in touch with your nearest sales office. By agreement we will take packing material back, if it is sorted. You must bear the costs of transport. For packing material that is returned to us unsorted or which we are not obliged to accept, we shall have to invoice you for any costs incurred.

### **Product and functional safety devices/applications or medical devices/applications**

OSRAM OS components are not developed, constructed or tested for the application as safety relevant component or for the application in medical devices.

OSRAM OS products are not qualified at module and system level for such application.

In case buyer – or customer supplied by buyer – considers using OSRAM OS components in product safety devices/applications or medical devices/applications, buyer and/or customer has to inform the local sales partner of OSRAM OS immediately and OSRAM OS and buyer and /or customer will analyze and coordinate the customer-specific request between OSRAM OS and buyer and/or customer.

---

## Glossary

- 1) **Brightness:** Brightness values are measured during a current pulse of typically 25 ms, with an internal reproducibility of  $\pm 8\%$  and an expanded uncertainty of  $\pm 11\%$  (acc. to GUM with a coverage factor of  $k = 3$ ).
- 2) **Wavelength:** The wavelength is measured at a current pulse of typically 25 ms, with an internal reproducibility of  $\pm 0.5$  nm and an expanded uncertainty of  $\pm 1$  nm (acc. to GUM with a coverage factor of  $k = 3$ ).
- 3) **Forward Voltage:** The forward voltage is measured during a current pulse of typically 8 ms, with an internal reproducibility of  $\pm 0.05$  V and an expanded uncertainty of  $\pm 0.1$  V (acc. to GUM with a coverage factor of  $k = 3$ ).
- 4) **Thermal Resistance:**  $R_{th\ max}$  is based on statistic values ( $6\sigma$ ).
- 5) **Typical Values:** Due to the special conditions of the manufacturing processes of semiconductor devices, the typical data or calculated correlations of technical parameters can only reflect statistical figures. These do not necessarily correspond to the actual parameters of each single product, which could differ from the typical data and calculated correlations or the typical characteristic line. If requested, e.g. because of technical improvements, these typ. data will be changed without any further notice.
- 6) **Characteristic curve:** In the range where the line of the graph is broken, you must expect higher differences between single devices within one packing unit.
- 7) **Tolerance of Measure:** Unless otherwise noted in drawing, tolerances are specified with  $\pm 0.1$  and dimensions are specified in mm.
- 8) **Tape and Reel:** All dimensions and tolerances are specified acc. IEC 60286-3 and specified in mm.

## Revision History

Version	Date	Change
1.7	2019-01-07	Additional Information
1.8	2020-07-17	Ordering Information

Published by OSRAM Opto Semiconductors GmbH EU RoHS and China RoHS compliant product  
Leibnizstraße 4, D-93055 Regensburg  
www.osram-os.com © All Rights Reserved.



此产品符合欧盟 RoHS 指令的要求；  
按照中国的相关法规和标准，不含有毒有害物质或元素。





## Стандарт Электрон Связь

Мы молодая и активно развивающаяся компания в области поставок электронных компонентов. Мы поставляем электронные компоненты отечественного и импортного производства напрямую от производителей и с крупнейших складов мира.

Благодаря сотрудничеству с мировыми поставщиками мы осуществляем комплексные и плановые поставки широчайшего спектра электронных компонентов.

Собственная эффективная логистика и склад в обеспечивает надежную поставку продукции в точно указанные сроки по всей России.

Мы осуществляем техническую поддержку нашим клиентам и предпродажную проверку качества продукции. На все поставляемые продукты мы предоставляем гарантию .

Осуществляем поставки продукции под контролем ВП МО РФ на предприятия военно-промышленного комплекса России , а также работаем в рамках 275 ФЗ с открытием отдельных счетов в уполномоченном банке. Система менеджмента качества компании соответствует требованиям ГОСТ ISO 9001.

Минимальные сроки поставки, гибкие цены, неограниченный ассортимент и индивидуальный подход к клиентам являются основой для выстраивания долгосрочного и эффективного сотрудничества с предприятиями радиоэлектронной промышленности, предприятиями ВПК и научно-исследовательскими институтами России.

С нами вы становитесь еще успешнее!

### Наши контакты:

**Телефон:** +7 812 627 14 35

**Электронная почта:** [sales@st-electron.ru](mailto:sales@st-electron.ru)

**Адрес:** 198099, Санкт-Петербург,  
Промышленная ул, дом № 19, литера Н,  
помещение 100-Н Офис 331