

**BiMOSFET™ Monolithic  
Bipolar MOS Transistor**
**IXBK75N170A  
IXBX75N170A**

$$V_{CES} = 1700V$$

$$I_{C90} = 65A$$

$$V_{CE(sat)} \leq 6.00V$$

$$t_{fi(typ)} = 60ns$$

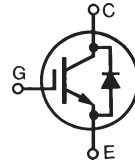

Symbol	Test Conditions	Maximum Ratings	
$V_{CES}$	$T_J = 25^\circ C$ to $150^\circ C$	1700	V
$V_{CGR}$	$T_J = 25^\circ C$ to $150^\circ C$ , $R_{GE} = 1M\Omega$	1700	V
$V_{GES}$	Continuous	$\pm 20$	V
$V_{GEM}$	Transient	$\pm 30$	V
$I_{C25}$	$T_C = 25^\circ C$	110	A
$I_{C90}$	$T_C = 90^\circ C$	65	A
$I_{CM}$	$T_C = 25^\circ C$ , 1ms	300	A
<b>SSOA</b>	$V_{GE} = 15V$ , $T_{VJ} = 125^\circ C$ , $R_G = 1\Omega$	$I_{CM} = 100$	A
<b>(RBSOA)</b>	Clamped Inductive Load	$V_{CE} \leq 0.8 \cdot V_{CES}$	
$P_C$	$T_C = 25^\circ C$	1040	W
$T_J$		-55 ... +150	$^\circ C$
$T_{JM}$		150	$^\circ C$
$T_{stg}$		-55 ... +150	$^\circ C$
$T_L$	Maximum Lead Temperature for Soldering	300	$^\circ C$
$T_{SOLD}$	1.6 mm (0.062 in.) from Case for 10	260	$^\circ C$
$M_d$	Mounting Torque (TO-264 )	1.13/10	Nm/lb.in.
$F_c$	Mounting Force (PLUS247 )	20..120/4.5..27	N/lb.
<b>Weight</b>	TO-264	10	g
	PLUS247	6	g

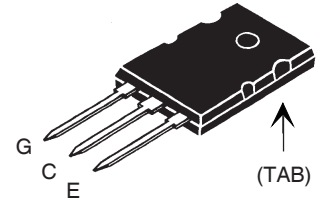
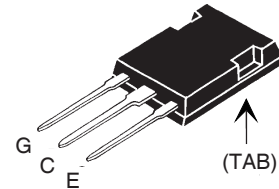
**TO-264 (IXBK)**

**PLUS247™ (IXBX)**

G = Gate                      C = Collector  
E = Emitter                  TAB = Collector

**Features**

- International Standard Packages
- High Blocking Voltage
- Fast Switching
- High Current Handling Capability
- Anti-Parallel Diode

**Advantages**

- High Power Density
- Low Gate Drive Requirement
- Intergrated Diode Can Be Used for Protection

**Applications**

- Switched-Mode and Resonant-Mode Power Supplies
- UPS
- AC Motor Drives
- Substitutes for High Voltage MOSFETs

Symbol	Test Conditions ( $T_J = 25^\circ C$ , Unless Otherwise Specified)	Characteristic Values		
		Min.	Typ.	Max.
$BV_{CES}$	$I_C = 250\mu A$ , $V_{GE} = 0V$	1700		V
$V_{GE(th)}$	$I_C = 1.5mA$ , $V_{CE} = V_{GE}$	2.5		5.5 V
$I_{CES}$	$V_{CE} = 0.8 \cdot V_{CES}$ , $V_{GE} = 0V$ $T_J = 125^\circ C$			50 $\mu A$ 3 mA
$I_{GES}$	$V_{CE} = 0V$ , $V_{GE} = \pm 20V$			$\pm 100$ nA
$V_{CE(sat)}$	$I_C = 42A$ , $V_{GE} = 15V$ , Note 1 $T_J = 125^\circ C$		4.95 5.15	6.00 V V

### Symbol Test Conditions

( $T_J = 25^\circ\text{C}$  Unless Otherwise Specified)

### Characteristic Values

		Min.	Typ.	Max.	
$g_{fs}$	$I_C = 42\text{A}, V_{CE} = 10\text{V}, \text{Note 1}$	28	48		S
$C_{ies}$	$V_{CE} = 25\text{V}, V_{GE} = 0\text{V}, f = 1\text{MHz}$		7200		pF
$C_{oes}$			450		pF
$C_{res}$			150		pF
$Q_g$	$I_C = 42\text{A}, V_{GE} = 15\text{V}, V_{CE} = 0.5 \cdot V_{CES}$		358		nC
$Q_{ge}$			46		nC
$Q_{gc}$			148		nC
$t_{d(on)}$	<b>Inductive load, <math>T_J = 25^\circ\text{C}</math></b> $I_C = 42\text{A}, V_{GE} = 15\text{V}$ $V_{CE} = 0.8 \cdot V_{CES}, R_G = 1\Omega$ Note 2		26		ns
$t_{ri}$			40		ns
$t_{d(off)}$			418		ns
$t_{fi}$			60	110	ns
$E_{off}$			3.80	7.00	mJ
$t_{d(on)}$	<b>Inductive load, <math>T_J = 125^\circ\text{C}</math></b> $I_C = 42\text{A}, V_{GE} = 15\text{V}$ $V_{CE} = 0.8 \cdot V_{CES}, R_G = 1\Omega$ Note 2		27		ns
$t_{ri}$			38		ns
$t_{d(off)}$			420		ns
$t_{fi}$			175		ns
$E_{off}$			6.35		mJ
$R_{thJC}$				0.12	$^\circ\text{C/W}$
$R_{thCS}$			0.15		$^\circ\text{C/W}$

### TO-264 AA (IXBK) Outline

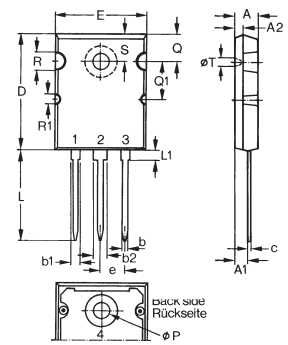

Dim.	Millimeter		Inches	
	Min.	Max.	Min.	Max.
A	4.82	5.13	.190	.202
A1	2.54	2.89	.100	.114
A2	2.00	2.10	.079	.083
b	1.12	1.42	.044	.056
b1	2.39	2.69	.094	.106
b2	2.90	3.09	.114	.122
c	0.53	0.83	.021	.033
D	25.91	26.16	1.020	1.030
E	19.81	19.96	.780	.786
e	5.46 BSC		.215 BSC	
J	0.00	0.25	.000	.010
K	0.00	0.25	.000	.010
L	20.32	20.83	.800	.820
L1	2.29	2.59	.090	.102
P	3.17	3.66	.125	.144
Q	6.07	6.27	.239	.247
Q1	8.38	8.69	.330	.342
R	3.81	4.32	.150	.170
R1	1.78	2.29	.070	.090
S	6.04	6.30	.238	.248
T	1.57	1.83	.062	.072

### Reverse Diode

### Symbol Test Conditions

( $T_J = 25^\circ\text{C}$  Unless Otherwise Specified)

### Characteristic Values

		Min.	Typ.	Max.	
$V_F$	$I_F = 42\text{A}, V_{GE} = 0\text{V}, \text{Note 1}$			4.2	V
$t_{rr}$	$I_F = 42\text{A}, V_{GE} = 0\text{V}, -di_F/dt = 100\text{A}/\mu\text{s}$		360		ns
$I_{RM}$			19		A
$Q_{RM}$	$V_R = 100\text{V}, V_{GE} = 0\text{V}$		3.5		$\mu\text{C}$

### Notes:

1. Pulse test,  $t \leq 300\mu\text{s}$ ; duty cycle,  $d \leq 2\%$ .
2. Switching times & energy losses may increase for higher  $V_{CE}$  (Clamp),  $T_J$  or  $R_G$ .

Additional provisions for lead-to-lead isolation are required at  $V_{CE} > 1200\text{V}$ .

### ADVANCE TECHNICAL INFORMATION

The product presented herein is under development. The Technical Specifications offered are derived from a subjective evaluation of the design, based upon prior knowledge and experience, and constitute a "considered reflection" of the anticipated result. IXYS reserves the right to change limits, test conditions, and dimensions without notice.

IXYS Reserves the Right to Change Limits, Test Conditions, and Dimensions.

IXYS MOSFETs and IGBTs are covered by one or more of the following U.S. patents:	4,835,592	4,931,844	5,049,961	5,237,481	6,162,665	6,404,065 B1	6,683,344	6,727,585	7,005,734 B2	7,157,338 B2
	4,850,072	5,017,508	5,063,307	5,381,025	6,259,123 B1	6,534,343	6,710,405 B2	6,759,692	7,063,975 B2	
	4,881,106	5,034,796	5,187,117	5,486,715	6,306,728 B1	6,583,505	6,710,463	6,771,478 B2	7,071,537	

### PLUS 247™ (IXBX) Outline

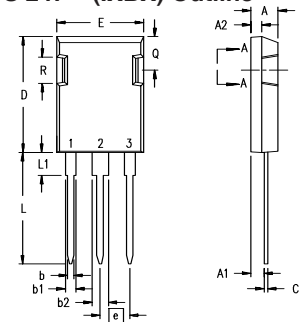

Terminals: 1 - Gate  
2 - Drain (Collector)  
3 - Source (Emitter)

Dim.	Millimeter		Inches	
	Min.	Max.	Min.	Max.
A	4.83	5.21	.190	.205
A <sub>1</sub>	2.29	2.54	.090	.100
A <sub>2</sub>	1.91	2.16	.075	.085
b	1.14	1.40	.045	.055
b <sub>1</sub>	1.91	2.13	.075	.084
b <sub>2</sub>	2.92	3.12	.115	.123
C	0.61	0.80	.024	.031
D	20.80	21.34	.819	.840
E	15.75	16.13	.620	.635
e	5.45 BSC		.215 BSC	
L	19.81	20.32	.780	.800
L1	3.81	4.32	.150	.170
Q	5.59	6.20	.220	0.244
R	4.32	4.83	.170	.190

**Fig. 1. Output Characteristics**  
**@ 25°C**

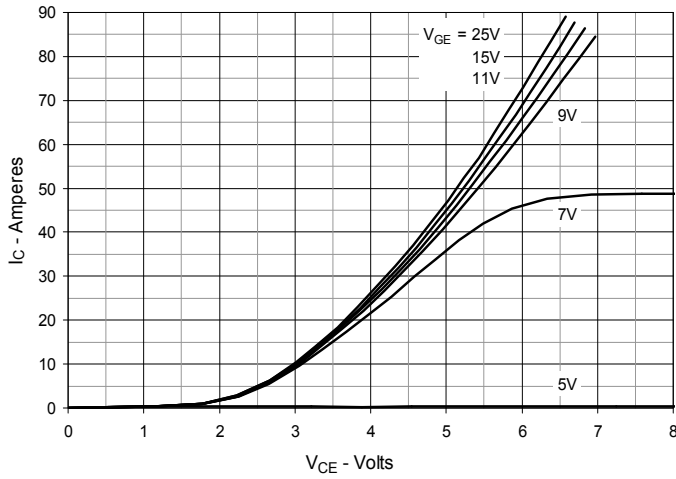

**Fig. 2. Extended Output Characteristics**  
**@ 25°C**

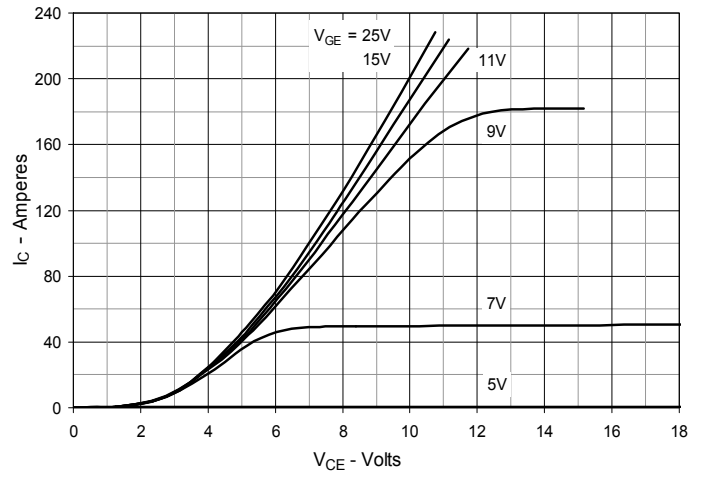

**Fig. 3. Output Characteristics**  
**@ 125°C**

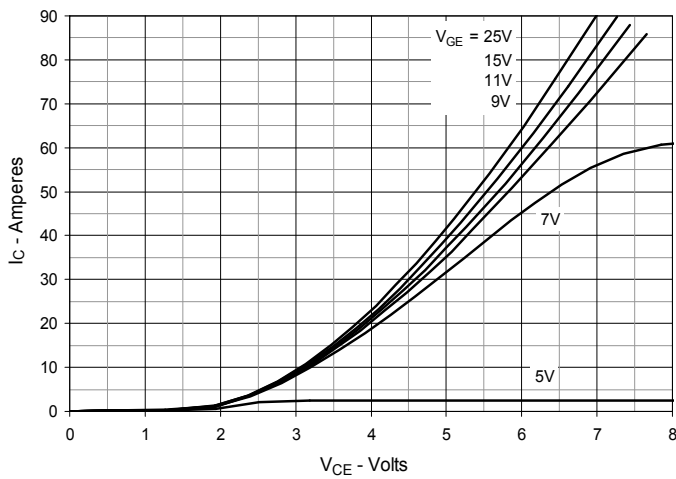

**Fig. 4. Dependence of  $V_{CE(sat)}$  on**  
**Junction Temperature**

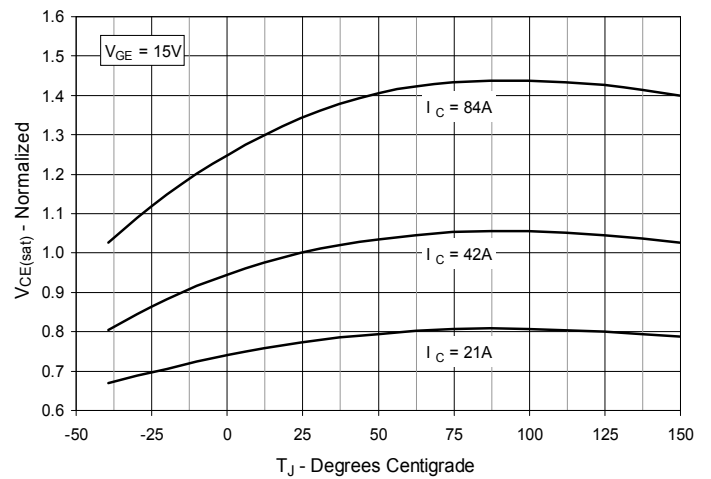

**Fig. 5. Collector-to-Emitter Voltage**  
**vs. Gate-to-Emitter Voltage**

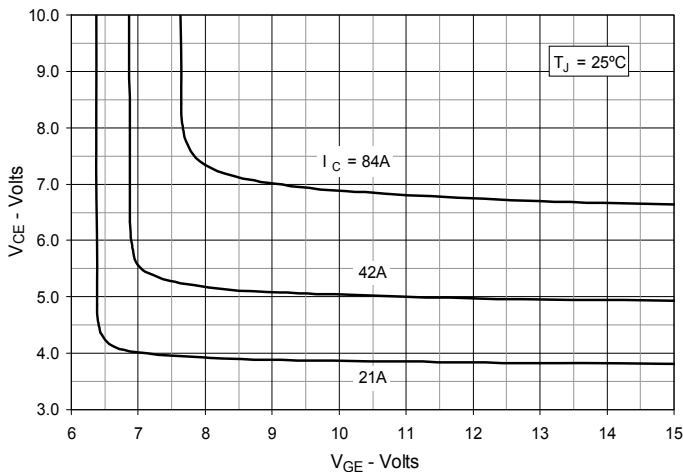

**Fig. 6. Input Admittance**

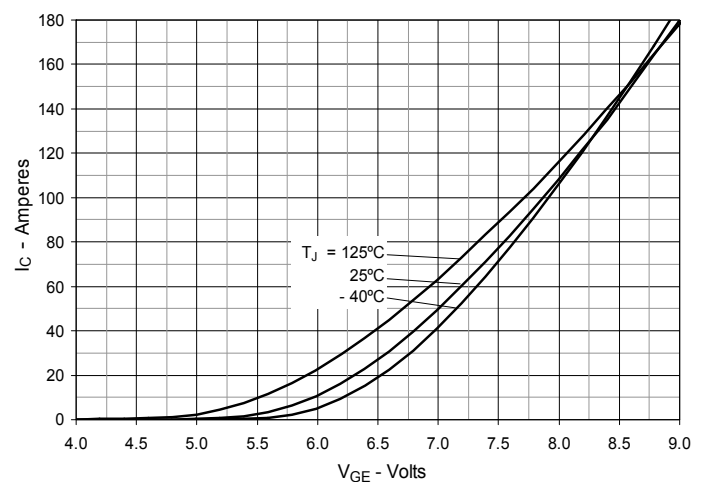

**Fig. 7. Transconductance**

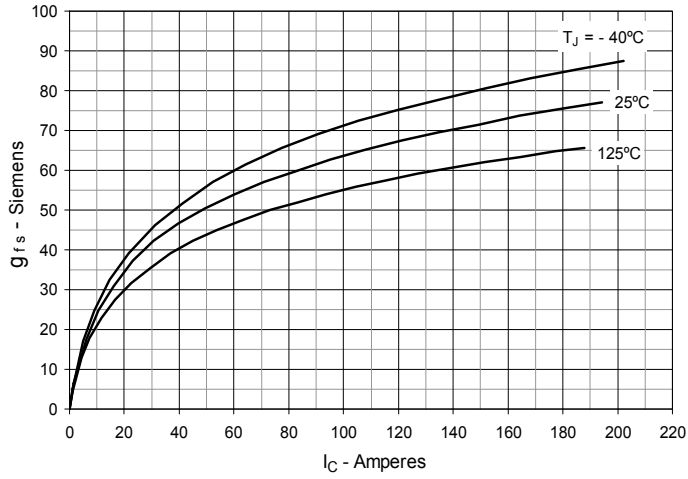

**Fig. 8. Gate Charge**

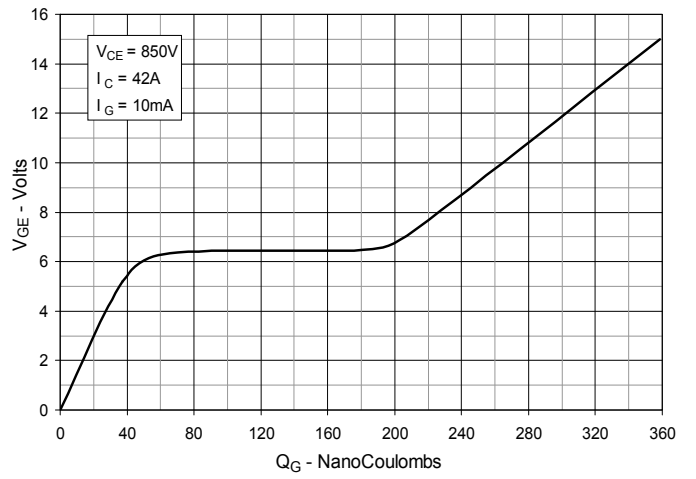

**Fig. 9. Forward Voltage Drop of Intrinsic Diode**

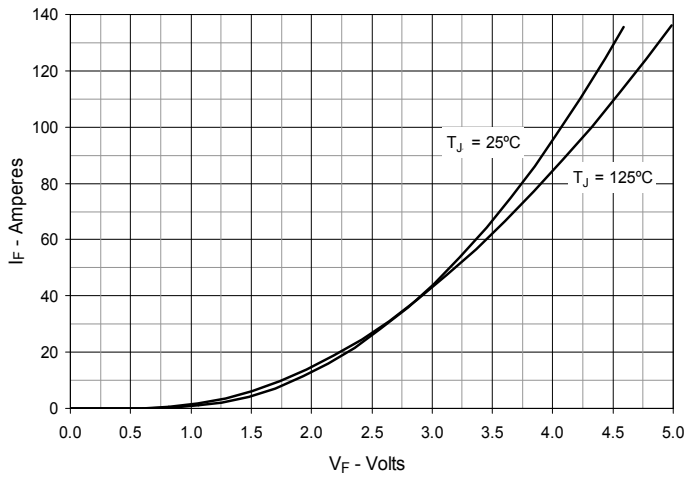

**Fig. 10. Capacitance**

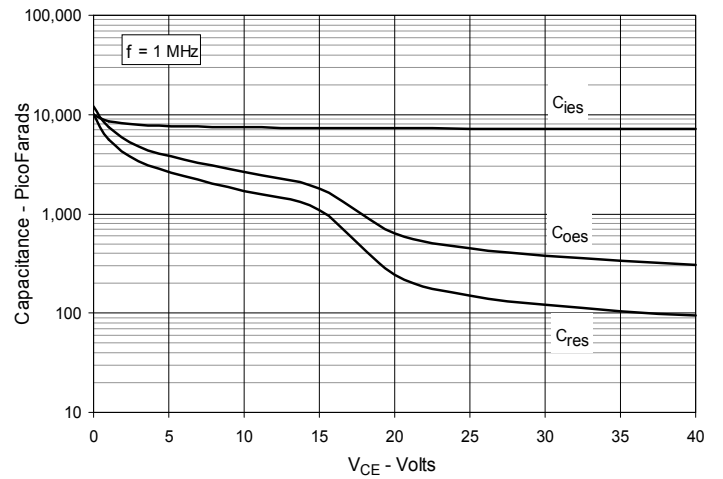

**Fig. 11. Reverse-Bias Safe Operating Area**

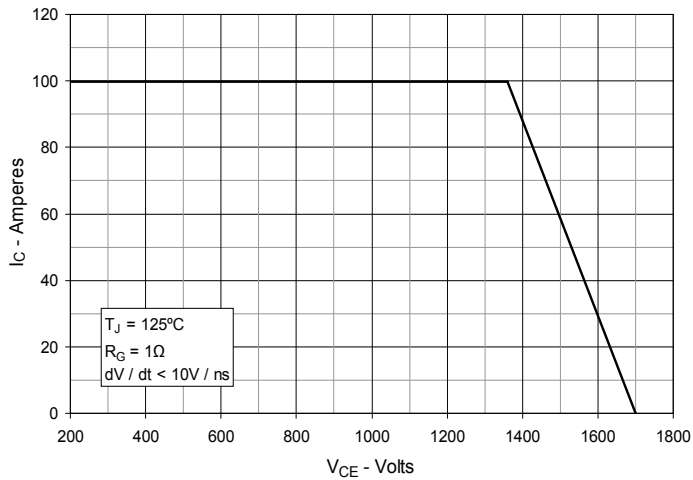

**Fig. 12. Maximum Transient Thermal Impedance**

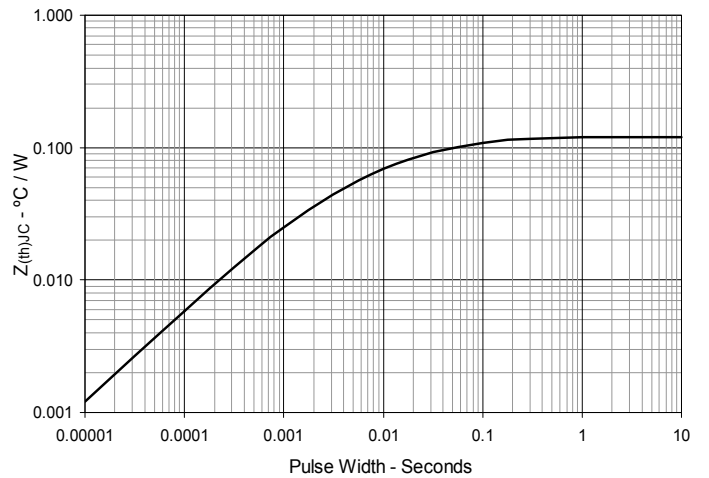

**Fig. 13. Inductive Turn-off**  
**Switching Energy Loss vs. Gate Resistance**

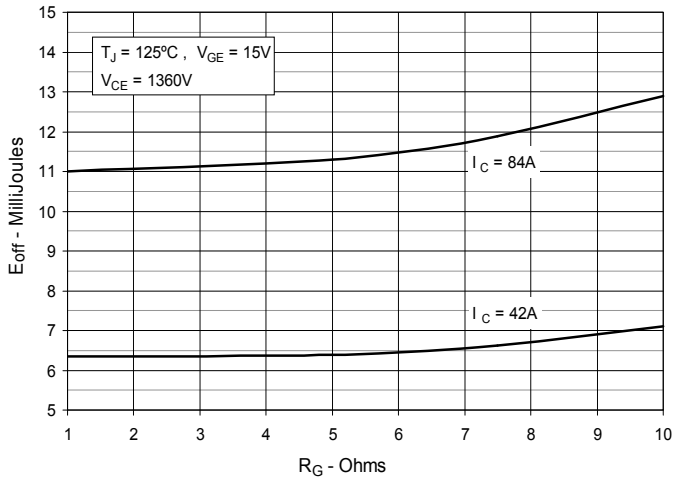

**Fig. 14. Inductive Turn-off**  
**Switching Energy Loss vs. Collector Current**

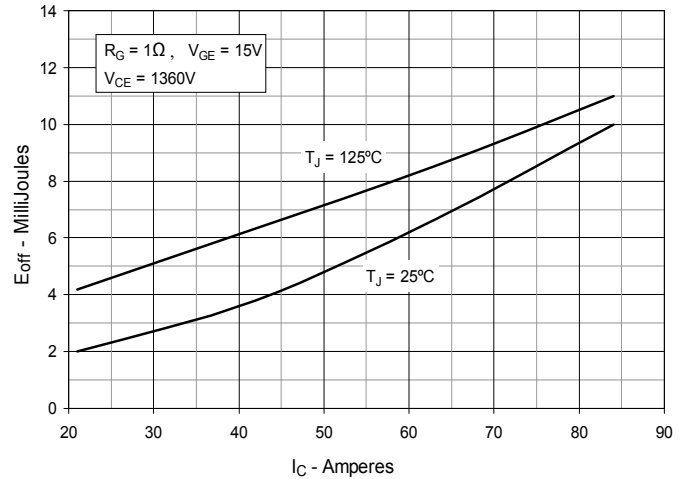

**Fig. 15. Inductive Turn-off**  
**Switching Energy Loss vs. Junction Temperature**

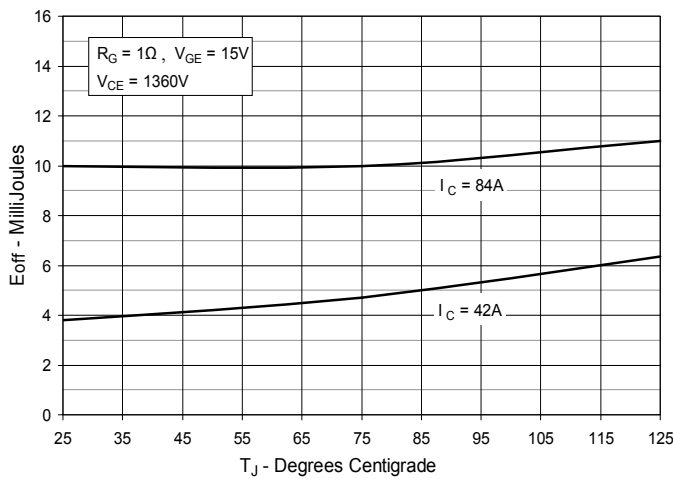

**Fig. 16. Inductive Turn-off**  
**Switching Times vs. Gate Resistance**

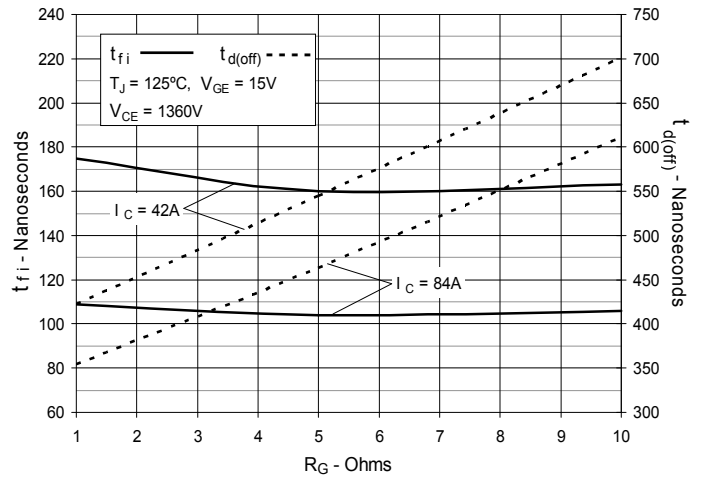

**Fig. 17. Inductive Turn-off**  
**Switching Times vs. Collector Current**

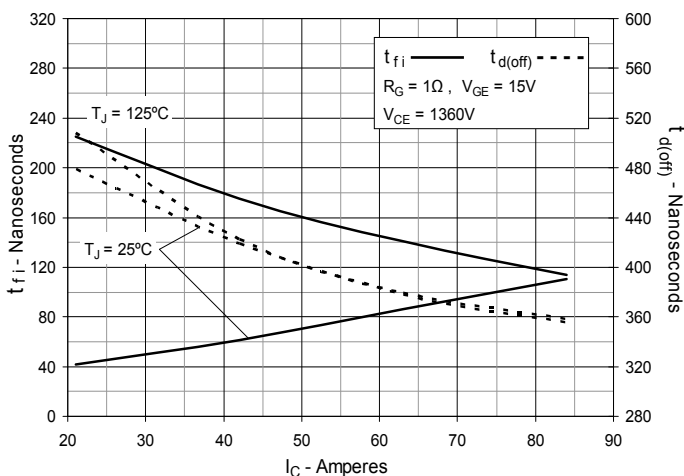

**Fig. 18. Inductive Turn-off**  
**Switching Times vs. Junction Temperature**

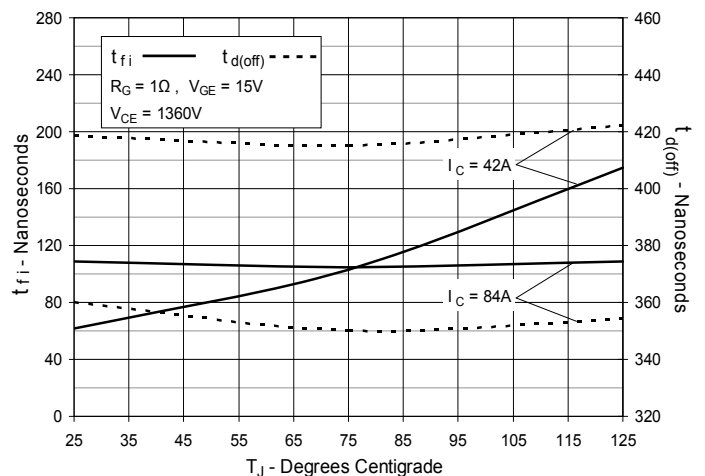

**Fig. 19. Inductive Turn-on  
Switching Times vs. Gate Resistance**

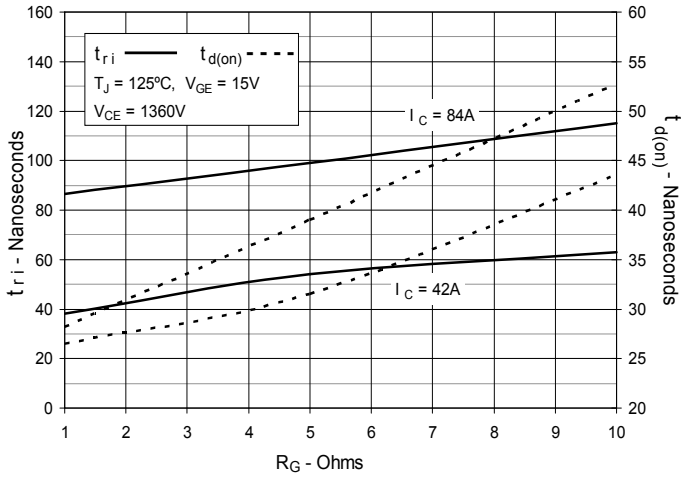

**Fig. 20. Inductive Turn-on  
Switching Times vs. Collector Current**

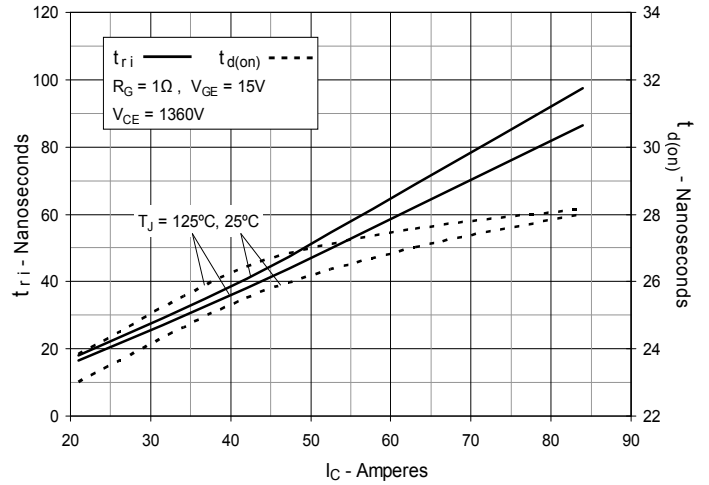

**Fig. 21. Inductive Turn-on  
Switching Times vs. Junction Temperature**

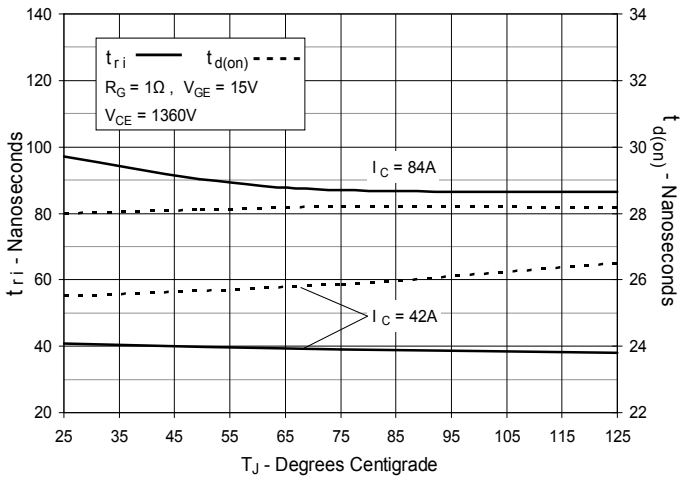



## Стандарт Электрон Связь

Мы молодая и активно развивающаяся компания в области поставок электронных компонентов. Мы поставляем электронные компоненты отечественного и импортного производства напрямую от производителей и с крупнейших складов мира.

Благодаря сотрудничеству с мировыми поставщиками мы осуществляем комплексные и плановые поставки широчайшего спектра электронных компонентов.

Собственная эффективная логистика и склад в обеспечивает надежную поставку продукции в точно указанные сроки по всей России.

Мы осуществляем техническую поддержку нашим клиентам и предпродажную проверку качества продукции. На все поставляемые продукты мы предоставляем гарантию .

Осуществляем поставки продукции под контролем ВП МО РФ на предприятия военно-промышленного комплекса России , а также работаем в рамках 275 ФЗ с открытием отдельных счетов в уполномоченном банке. Система менеджмента качества компании соответствует требованиям ГОСТ ISO 9001.

Минимальные сроки поставки, гибкие цены, неограниченный ассортимент и индивидуальный подход к клиентам являются основой для выстраивания долгосрочного и эффективного сотрудничества с предприятиями радиоэлектронной промышленности, предприятиями ВПК и научно-исследовательскими институтами России.

С нами вы становитесь еще успешнее!

### Наши контакты:

**Телефон:** +7 812 627 14 35

**Электронная почта:** [sales@st-electron.ru](mailto:sales@st-electron.ru)

**Адрес:** 198099, Санкт-Петербург,  
Промышленная ул, дом № 19, литера Н,  
помещение 100-Н Офис 331