



## Features

- Radial leaded devices
- Fast tripping resettable PTCs
- Binned and sorted narrow resistance ranges available
- RoHS compliant\*
- Agency recognition:   

## Applications

- Customer Premise Equipment (CPE)
- Central Office / Telecom Centers (CO)
- Access equipment

# MF-RX/250 Series - Telecom PTC Resettable Fuses

### Electrical Characteristics

Model	Max. Operating Voltage (Vdc)	Max. Interrupt Ratings		Hold Current	Initial Resistance		One Hour Post-Trip Resistance
		Volts (Vrms)	Amps (A)		Amps at 23 °C	Ohms at 23 °C	
		Max.	Max.	I <sub>H</sub>	Min.	Max.	Max.
MF-RX012/250	60	250	3.0	0.12	4.0	8.0	16.0
MF-RX012/250-A	60	250	3.0	0.12	7.0	9.0	16.0
MF-RX012/250-C	60	250	3.0	0.12	5.5	7.5	14.0
MF-RX012/250-F	60	250	3.0	0.12	6.0	10.5	16.0
MF-RX012/250-1	60	250	3.0	0.12	6.0	9.0	16.0
MF-RX012/250-2	60	250	3.0	0.12	8.0	10.5	16.0
MF-RX012/250-T	60	250	3.0	0.12	7.0	12.0	16.0
MF-RX012/250U	60	250	3.0	0.12	6.0	10.0	16.0
MF-RX014/250	60	250	3.0	0.145	3.0	6.0	14.0
MF-RX014/250-A	60	250	3.0	0.145	3.0	5.5	12.0
MF-RX014/250-B	60	250	3.0	0.145	4.5	6.0	14.0
MF-RX014/250-T	60	250	3.0	0.145	5.4	7.5	14.0
MF-RX014/250U	60	250	3.0	0.145	3.5	6.5	12.0
MF-RX018/250	60	250	10.0	0.18	0.8	2.0	4.0
MF-RX018/250U	60	250	10.0	0.18	0.8	2.0	4.0

\*"U" suffix indicates product without insulation coating.

### Environmental Characteristics

Operating/Storage Temperature.....	-40 °C to +85 °C	
Maximum Device Surface Temperature in Tripped State .....	125 °C	
Passive Aging .....	+85 °C, 1000 hours..... ±15 % typical resistance change	
.....	+60°C, 1000 hours..... ±15 % typical resistance change	
Humidity Aging .....	+85 °C, 85 % R.H. 500 hours..... ±15 % typical resistance change	
Thermal Shock .....	MIL-STD-202F, Method 107G, .....	±10 % typical resistance change
.....	+125 °C to -55 °C, 10 times .....	±15 % typical resistance change
Solvent Resistance.....	MIL-STD-202, Method 215B .....	No change
Lead Solderability .....	ANSI/J-STD-002 .....	>95 % coverage
Flammability .....	IEC 695-2-2 .....	No Flame for 60 secs.
Vibration .....	MIL-STD-883C, Method 2007.1, Condition A .....	±5 % typical resistance change

### Test Procedures And Requirements For Model MF-RX/250 Series

Test	Test Conditions	Accept/Reject Criteria
Visual/Mech .....	Verify dimensions and materials .....	Per MF physical description
Resistance .....	In still air @ 23 °C.....	$R_{min} \leq R \leq R_{max}$
Time to Trip.....	5 times I <sub>hold</sub> , V <sub>max</sub> , 23 °C .....	$T \leq \text{max. time to trip (seconds)}$
Hold Current .....	30 min. at I <sub>hold</sub> .....	No trip
Trip Cycle Life .....	V <sub>max</sub> , I <sub>max</sub> , 100 cycles.....	No arcing or burning
Trip Endurance .....	V <sub>max</sub> , 48 hours.....	No arcing or burning
UL File Number .....	E 174545S	
CSA File Number .....	CA 110338	
TÜV File Number .....	R2057213	

\*RoHS Directive 2002/95/EC Jan 27, 2003 including Annex.

Specifications are subject to change without notice.

Customers should verify actual device performance in their specific applications.

## Additional Features

- Ability to withstand AC power cross conditions
- Assists equipment with meeting ITU-T K.20/K.21/K.45
- Assists equipment with meeting Telcordia GR-1089-C Intrabuilding

## MF-RX/250 Series - Telecom PTC Resettable Fuses

**BOURNS®**

### Thermal Derating Chart - $I_{hold}$ (Amps)

Model	Ambient Operating Temperature								
	-40 °C	-20 °C	0 °C	23 °C	40 °C	50 °C	60 °C	70 °C	85 °C
MF-RX012/250	0.186	0.165	0.143	0.120	0.099	0.088	0.077	0.066	0.050
MF-RX014/250	0.225	0.199	0.172	0.145	0.119	0.106	0.093	0.080	0.060
MF-RX018/250	0.269	0.240	0.211	0.180	0.153	0.138	0.123	0.109	0.087

$I_{trip}$  is approximately two times  $I_{hold}$ .

### Product Dimensions

Model	A Max.	B Max.	C Nom.	D Min.	E Max.	Physical Characteristics		
						Lead Dia.	Style	Material
MF-RX012/250	6.5 (0.256)	11.0 (0.433)	5.1 ± 0.7 (0.201 ± 0.028)	4.7 (0.185)	4.6 (0.181)	0.65 (0.026)	1	Sn/Cu
MF-RX012/250U	6.0 (0.236)	10.0 (0.394)	5.1 ± 0.7 (0.201 ± 0.028)	4.7 (0.185)	3.8 (0.150)	0.65 (0.026)	2	Sn/Cu
MF-RX014/250	6.5 (0.256)	11.0 (0.433)	5.1 ± 0.7 (0.201 ± 0.028)	4.7 (0.185)	4.6 (0.181)	0.65 (0.026)	1	Sn/Cu
MF-RX014/250U	6.0 (0.236)	10.0 (0.394)	5.1 ± 0.7 (0.201 ± 0.028)	4.7 (0.185)	3.8 (0.150)	0.65 (0.026)	2	Sn/Cu
MF-RX018/250	11.0 (0.433)	13.6 (0.535)	5.1 ± 0.7 (0.201 ± 0.028)	4.7 (0.185)	4.6 (0.181)	0.65 (0.026)	1	Sn/Cu
MF-RX018/250U	10.4 (0.409)	12.6 (0.496)	5.1 ± 0.7 (0.201 ± 0.028)	4.7 (0.185)	3.8 (0.150)	0.65 (0.026)	2	Sn/Cu

Packaging options: BULK: 500 pcs. per bag. TAPE & REEL: 1500 pcs. per reel (available binned).

DIMENSIONS:  $\frac{MM}{(INCHES)}$

Style 1

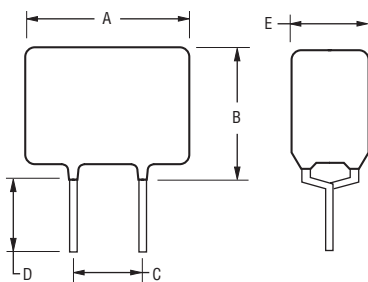

Style 2



### Typical Part Marking

Represents total content. Layout may vary.

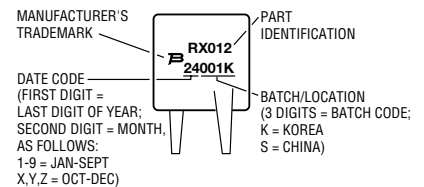

NOTE: UNCOATED PARTS HAVE NO PART MARKING. MARKING IS ON LABEL ONLY.

# MF-RX/250 Series - Telecom PTC Resettable Fuses

**BOURNS®**

## How to Order

**MF - RX 012/250 U - A 5 - 2**

Multifuse®  
Product  
Designator

Series

RX = Radial Leaded  
Component

Hold Current,  $I_{hold}$   
008-018 (0.08-0.18 Amps)

Max. Interrupt Voltage, V  
250 (250 Volts)

Telecom Options  
U = Uncoated (radial parts only)

Resistance Sorted  
Narrow resistance ranges - see  
Resistance Options chart

Resistance Bins of 0.5 ohms  
05 = 0.5 ohm binned parts (epoxy coated)  
5 = 0.5 ohm binned parts (uncoated)

Packaging Options

- 0 = Bulk Packaging
- 2 = Tape and Reel\* (available with binned option)

\*Packaged per EIA486-B

## Typical Time to Trip at 23 °C

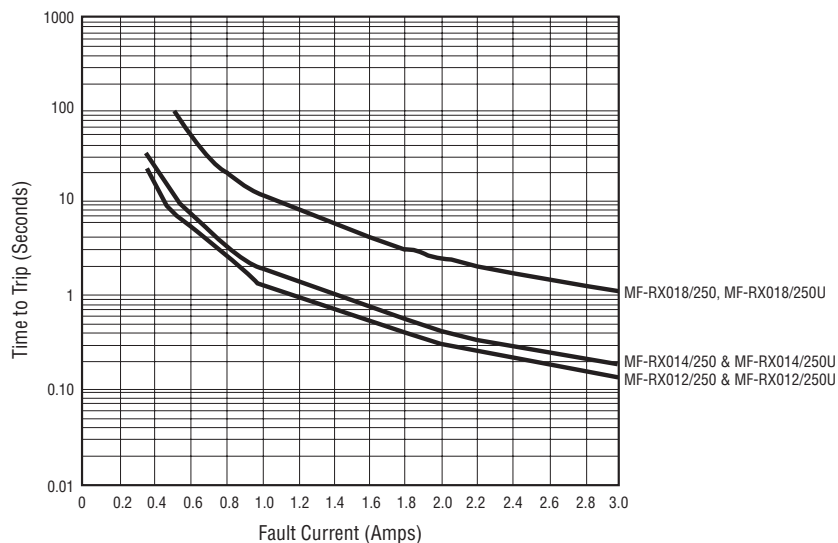

## Resistance Options

Model	Initial Resistance Values		R1max	Bin
	Ohms @ 23 ° C		Ohms @ 23 ° C	
	Min.	Max.	Max.	
MF-RX012/250	4.0	8.0	16.0	0.5
MF-RX012/250-A05	7.0	9.0	16.0	0.5
MF-RX012/250-C05	5.5	7.5	14.0	0.5
MF-RX012/250-F05	6.0	10.5	16.0	0.5
MF-RX012/250-105	6.0	9.0	16.0	0.5
MF-RX012/250-205	8.0	10.5	16.0	0.5
MF-RX012/250-T05	7.0	12.0	16.0	0.5
MF-RX012/250U	6.0	10.0	16.0	0.5
MF-RX014/250	3.0	6.0	14.0	0.5
MF-RX014/250-A05	3.0	5.5	12.0	0.5
MF-RX014/250-B05	4.5	6.0	14.0	0.5
MF-RX014/250U	3.5	6.5	12.0	0.5

MF-RX/250, REV. J, 05/11

Specifications are subject to change without notice.  
Customers should verify actual device performance in their specific applications.

# MF-R, MF-R/90, MF-R/600, MF-RX, MF-RX/72 & MF-RX/250 Series Tape and Reel Specifications

**BOURNS®**

Devices taped using EIA468-B/IEC286-2 standards. See table below and Figures 1 and 2 for details.

Dimension Description	IEC Mark	EIA Mark	Dimensions	
			Dimensions	Tolerance
Carrier tape width	$W$	$W$	$\frac{18}{(.709)}$	$\frac{-0.5/+1.0}{(-0.02/+0.039)}$
Hold down tape width	$W_0$	$W_4$	$\frac{11}{(.433)}$	min.
Hold down tape			No protrusion	
Top distance between tape edges	$W_2$	$W_6$	$\frac{3}{(.118)}$	max.
Sprocket hole position	$W_1$	$W_5$	$\frac{9}{(.354)}$	$\frac{-0.5/+0.75}{(-0.02/+0.03)}$
Sprocket hole diameter	$D_0$	$D_0$	$\frac{4}{(.157)}$	$\frac{\pm 0.2}{(\pm .0078)}$
Abscissa to plane (straight lead)	$H$	$H$	$\frac{18.5}{(.728)}$	$\frac{\pm 3.0}{(\pm .118)}$
Abscissa to plane (kinked lead)	$H_0$	$H_0$	$\frac{16}{(.63)}$	$\frac{\pm 0.5}{(\pm .02)}$
Abscissa to top (straight lead)	$H_1$	$H_1$	$\frac{38.0}{(1.496)}$	max.
Abscissa to top (kinked lead)	$H_1$	$H_1$	$\frac{32.2}{(1.268)}$	max.
Overall width w/lead protrusion (straight lead)		$C_1$	$\frac{55.0}{(2.165)}$	max.
Overall width w/lead protrusion (kinked lead)		$C_1$	$\frac{43.2}{(1.7)}$	max.
Overall width w/o lead protrusion (straight lead)		$C_2$	$\frac{54.0}{(2.126)}$	max.
Overall width w/o lead protrusion (kinked lead)		$C_2$	$\frac{42.5}{(1.673)}$	max.
Lead protrusion	$l_1$	$L_1$	$\frac{1.0}{(.039)}$	max.
Protrusion of cutout	$L$	$L$	$\frac{11}{(.433)}$	max.
Protrusion beyond hold-down tape	$l_2$	$l_2$	Not specified	
Sprocket hole pitch	$P_0$	$P_0$	$\frac{12.7}{(0.5)}$	$\frac{\pm 0.3}{(\pm .012)}$
Pitch tolerance			20 consecutive	$\frac{\pm 1}{(\pm .039)}$
Device pitch: MF-R005–MF-R160, MF-R/90, MF-RX110/72–MF-RX185/72			$\frac{12.7}{(0.5)}$	$\frac{\pm 0.3}{(\pm .012)}$
Device pitch: MF-R185–MF-R400, MF-RX110–MF-RX375 MF-R/600, MF-RX250/72–MF-RX375/72			$\frac{25.4}{(1.0)}$	$\frac{\pm 0.6}{(\pm .024)}$
Tape thickness	$t$	$t$	$\frac{0.9}{(.035)}$	max.
Tape thickness with splice: MF-R010–MF-R160, MF-RX110/72–MF-RX185/72		$t_1$	$\frac{1.5}{(.059)}$	max.
Tape thickness with splice: MF-R250–MF-R1100, MF-RX110–MF-RX375, MF-R/90, MF-RX250/72–MF-RX375/72		$t_1$	$\frac{2.3}{(.091)}$	max.
Splice sprocket hole alignment			0	$\frac{\pm 0.3}{(\pm .012)}$
Body lateral deviation	$\Delta_h$	$\Delta_h$	0	$\frac{\pm 1.0}{(\pm .039)}$
Body tape plane deviation	$\Delta_p$	$\Delta_p$	0	$\frac{\pm 1.3}{(\pm .051)}$

Specifications are subject to change without notice.  
Customers should verify actual device performance in their specific applications.

DIMENSIONS:  $\frac{\text{MM}}{\text{(INCHES)}}$

# MF-R, MF-R/90, MF-R/600, MF-RX, MF-RX/72 & MF-RX/250 Series Tape and Reel Specifications

**BOURNS®**

Dimension Description	IEC Mark	EIA Mark	Dimensions			
			Dimensions	Tolerance		
Lead spacing: MF-R, MF-R/90, MF-R/600, MF-RX, MF-RX/72	<i>F</i>	<i>F</i>	5.08 (0.2)	±0.2 (±0.008)		
Lead spacing: MF-RX/250	<i>F</i>	<i>F</i>	5.08 (0.2)	-0.5/+0.6 (-.020/+0.024)		
Reel width	<i>w</i>	<i>W</i> <sub>2</sub>	56.0 (2.205)	max.		
Reel diameter	<i>d</i>	<i>a</i>	370.0 (14.57)	max.		
Space between flanges less device	<i>W</i> <sub>1</sub>	<i>h</i>	4.75 (.187)	±3.25 (±.128)		
Arbor hole diameter	<i>f</i>	<i>c</i>	26.0 (1.024)	±12.0 (±.472)		
Core diameter: MF-R, MF-RX, MF-R/90	<i>h</i>	<i>n</i>	80 (3.15)	max.		
Core diameter: MF-RX/250, MF-R/600	<i>h</i>	<i>n</i>	91 (3.58)	max.		
Box: MF-R, MF-RX, MF-R/90			56 (2.2)	372 (14.6)	372 (14.6)	max.
Box: MF-RX/250			67 (2.64)	372 (14.6)	362 (14.25)	max.
Box: MF-R/600			64 (2.52)	372 (14.6)	362 (14.25)	max.
Consecutive missing places: MF-R, MF-RX, MF-R/90			3			max.
Consecutive missing places: MF-RX/250, MF-R/600			none			
Empty places per reel: MF-R, MF-RX, MF-R/90						Not specified
Empty places per reel: MF-RX/250, MF-R/600						0.1 %

**Taped Component Dimensions - Figure 1**

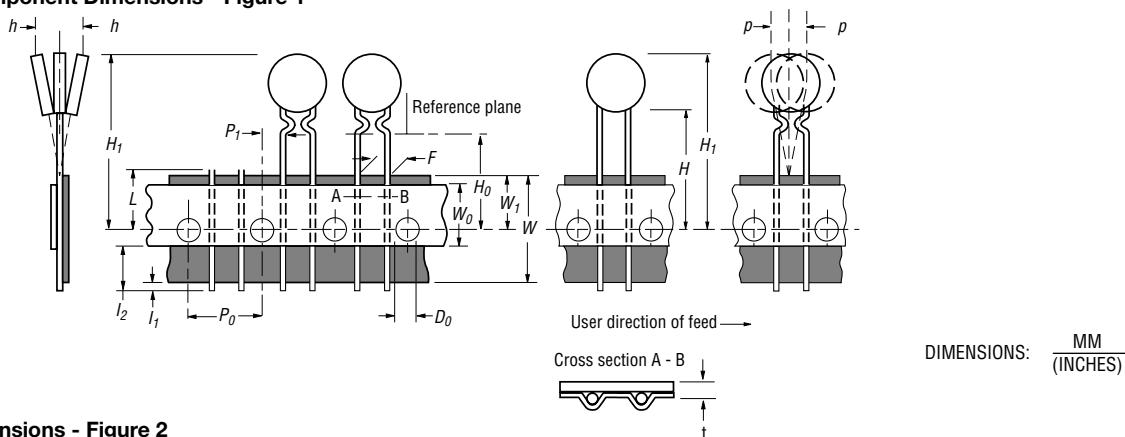

**Reel Dimensions - Figure 2**

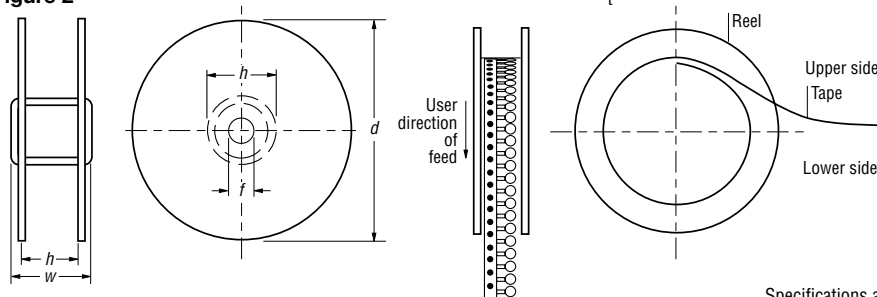

Specifications are subject to change without notice.  
Customers should verify actual device performance in their specific applications.



**Стандарт  
Электрон  
Связь**

Мы молодая и активно развивающаяся компания в области поставок электронных компонентов. Мы поставляем электронные компоненты отечественного и импортного производства напрямую от производителей и с крупнейших складов мира.

Благодаря сотрудничеству с мировыми поставщиками мы осуществляем комплексные и плановые поставки широчайшего спектра электронных компонентов.

Собственная эффективная логистика и склад в обеспечивает надежную поставку продукции в точно указанные сроки по всей России.

Мы осуществляем техническую поддержку нашим клиентам и предпродажную проверку качества продукции. На все поставляемые продукты мы предоставляем гарантию .

Осуществляем поставки продукции под контролем ВП МО РФ на предприятия военно-промышленного комплекса России , а также работаем в рамках 275 ФЗ с открытием отдельных счетов в уполномоченном банке. Система менеджмента качества компании соответствует требованиям ГОСТ ISO 9001.

Минимальные сроки поставки, гибкие цены, неограниченный ассортимент и индивидуальный подход к клиентам являются основой для выстраивания долгосрочного и эффективного сотрудничества с предприятиями радиоэлектронной промышленности, предприятиями ВПК и научно-исследовательскими институтами России.

С нами вы становитесь еще успешнее!

**Наши контакты:**

**Телефон:** +7 812 627 14 35

**Электронная почта:** [sales@st-electron.ru](mailto:sales@st-electron.ru)

**Адрес:** 198099, Санкт-Петербург,  
Промышленная ул, дом № 19, литера Н,  
помещение 100-Н Офис 331