



OeA4212-10.00M TCVCXO Oscillator

November 2010

- Pletronics' OeA4 is from the OeXO™ Series of temperature compensated voltage controlled crystal oscillator with a CMOS output.
- Tape and Reel packaging is available
- 5 x 7 mm LCC Ceramic Package
- Supply Voltage: 3.3V

Pletronics Inc. certifies this device is in accordance with the RoHS (2002/95/EC) and WEEE (2002/96/EC) directives.

Pletronics Inc. guarantees the device does not contain the following:
Cadmium, Hexavalent Chromium, Lead, Mercury, PBB's, PBDE's
Weight of the Device: 0.20 grams
Moisture Sensitivity Level: 1 As defined in J-STD-020D.1
Second Level Interconnect code: e4

Absolute Maximum Ratings:

Parameter	Unit
V _{CC} Supply Voltage	-0.5V to +6.5V
V _i Input Voltage	-0.5V to V _{CC} + 0.5V
V _o Output Voltage	-0.5V to V _{CC} + 0.5V



Thermal Characteristics

The maximum die or junction temperature is 155°C
The thermal resistance junction to board is 30 to 50°C/Watt depending on the solder pads, ground plane and construction of the PCB.

ESD Rating

Model	Minimum Voltage	Conditions
Human Body Model	1500	MIL-STD-883 Method 3115
Charged Device Model	1000	JESD 22-C101

Part Marking:

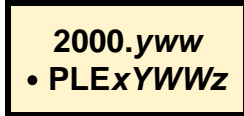

2000	=	20.00MHz, the crystal frequency
yww	=	Year and Week of the crystal manufacture
PLE	=	Pletronics
X	=	Model number, normally a "B"
YWW	=	Year and Week of assembly of the TCXO
Z	=	internal factory code

The actual part number is OEA4212-10.00M where the model number "212" is the specification number the part is made to. This is not included in the part marking. This is included on the label on the Tape and Reel.

Note that the crystal frequency is 2 times the specified frequency of 10.00MHz. The TCVCXO IC used divides the crystal frequency by 2 resulting in a 10.00MHz output





Reliability: Environmental Compliance

Parameter	Condition
Mechanical Shock	MIL-STD-883 Method 2002, Condition B
Vibration	MIL-STD-883 Method 2007, Condition A
Solderability	MIL-STD-883 Method 2003
Thermal Shock	MIL-STD-883 Method 1011, Condition A

Package Labeling

Label is 1" x 2.6" (25.4mm x 66.7mm)
 Font is Courier New
 Bar code is 39-Full ASCII
 The bar code will show the actual Part Number
 OEA4212-10.00M

Label is 1" x 2.6" (25.4mm x 66.7mm)
 Font is Arial

P/N: 	
OEA4xxx-ff.ffM	
Customer P/N: 	
123456	
Qty: 	D/C 
1000	0GD
MSL: 1	

<p>RoHS Compliant</p> <p>2nd Lvl Interconnect</p> <p>Category=e4</p> <p>Max Safe Temp=260C for 10s 2X Max</p>
--

Electrical Specification for specified $V_{CC}=3.30V \pm 5\%$ over the specified temperature range.

Item	Min	TYP	Max	Unit	Condition
Frequency Stability over temperature	-250	-	250	ppb	Over -40°C to 85°C at fixed supply voltage + load (reference to midpoint min/max frequency)
Holdover	-250 -125	0 0	250 125	ppb ppb	Over -40°C to 85°C for 24 hours Over $\pm 5^\circ\text{C}$ change for 24 hours
Frequency Calibration	-2.0	-	2.0	ppm	Frequency offset at 25°C, 60 minutes after reflow.
Supply voltage stability	-10	0	10	ppb	$\pm 2\%$ variation in supply voltage
Load sensitivity	-5	-	5	ppb	10K ohm $\pm 10\%$ 15 pF $\pm 10\%$
Warm Up	-	0.4	3.0	S	Time to reach specified frequency
Aging rate following reflow	- - -	± 10 ± 3 ± 1	- - -	ppb/day	1 day after reflow 7 days after reflow 30 days after reflow
Long term stability (Aging)	-1000 -1500 -4600	- - -	1000 1500 4600	ppb	after 1 year after 5 years after 15 years
Output Waveform	CMOS				
Output V_{HIGH}	90	-	-	%Vs	Load: 10K ohm $\pm 10\%$ 15 pF $\pm 10\%$ Vth: T_R and T_F 10% and 90% of amplitude Vth: D.C. 50% of amplitude
Output V_{LOW}	-	-	10	%Vs	
T_{RISE} and T_{FALL}	-	-	6.5	nS	
Duty Cycle	40	50	60	%	
Phase Noise 1 Hz 10 Hz 100 Hz 1 KHz 10 KHz 100 KHz	- - - - - -	-71 -93 -117 -138 -152 -155	- - - - - -	dBc/Hz	at 25°C
Jitter	-	-	0.6	pS	Frequency offset from carrier 12kHz to 20MHz
V Supply Range ¹ V_{CC}	3.13	3.30	3.47	Volts	
Supply Current I_{CC}	-	-	4.0	mA	
Vcontrol Range	0.5	-	2.50	Volts	1.50 volts nominal
Frequency Pullability	5	-	10	\pm ppm	Slope positive
Linearity	-	0.05	2.0	%	In accordance with MIL-PRF-55310
Operating Temperature	-40	-	+85	°C	Widest range allowed
Storage Temperature	-55	-	+95	°C	

Note: ¹ For correct operation a 10nF supply de-coupling capacitor should be placed next to the device.

Mechanical:

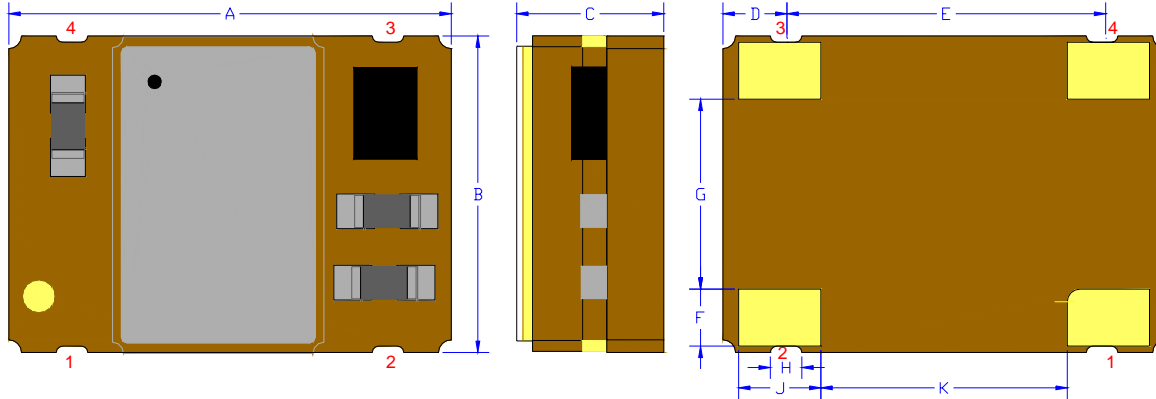

Not to Scale

Pad	Function	Note
1	Vcontrol Input	EFC, Electronic Frequency Control.
2	Ground (GND)	
3	Output	
4	Supply Voltage (V _{CC})	Recommend connecting appropriate power supply bypass capacitors as close as possible.

Contacts:

¹ Typical dimensions

Gold 11.8 to 39.4 μinches (0.3 to 1.0 μm) over
Nickel 50 to 350 μinches (1.27 to 8.89 μm)

	Inches	mm
A	0.276 ±0.006	7.00 ±0.15
B	0.197 ±0.006	5.00 ±0.15
C	0.099 max	2.50 max
D ¹	0.039	1.00
E ¹	0.197	5.00
F ¹	0.025	0.90
G ¹	0.118	3.00
H ¹	0.020	0.50
J ¹	0.051	1.30
K ¹	0.154	3.90

Layout and application information

There are additional pads on the package bottom, these are **not to be connected to any traces** on the PCB, solder masking on the PCB should be used to make sure no contact is made.

For Optimum Stability and Jitter Performance, Pletronics recommends:

- a ground plane under the device
- no large transient signals (both current and voltage) should be routed under the device
- do not layout near a large magnetic field such as a high frequency switching power supply
- minimize air flow across the device

Reflow Cycle (typical for lead free processing)



The part may be reflowed 2 times without degradation.

Tape and Reel: available for quantities of 250 to 1000 per reel, cut tape for < 250

Constant Dimensions Table 1								
Tape Size	D0	D1 Min	E1	P0	P2	S1 Min	T Max	T1 Max
8mm	1.5	1.0	1.75	4.0	2.0 ±0.05	0.6	0.6	0.1
12mm		1.5			2.0 ±0.1			
16mm		+0.1 -0.0			±0.1			
24mm		1.5			±0.1			

Variable Dimensions Table 2							
Tape Size	B1 Max	E2 Min	F	P1	T2 Max	W Max	Ao, Bo & Ko
16 mm	12.1	14.25	7.5 ±0.1	8.0 ±0.1	8.0	16.3	Note 1

Note 1: Embossed cavity to conform to EIA-481-B Dimensions in mm Not to scale

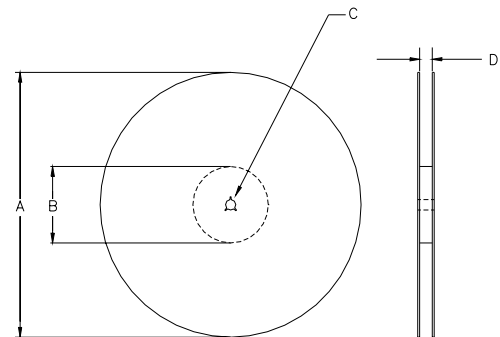

from the above

USER DIRECTION OF UNREELING →

REEL DIMENSIONS					
A	inches	7.0	10.0	13.0	Tape Width
	mm	177.8	254.0	330.2	
B	inches	2.50	4.00	3.75	Tape Width
	mm	63.5	101.6	95.3	
C	mm	13.0 +0.5 / -0.2			Tape Width
D	mm	16.4 +2.0 -0.0	16.4 +2.0 -0.0	16.4 +2.0 -0.0	

Reel dimensions may vary

IMPORTANT NOTICE

Pletronics Incorporated (PLE) reserves the right to make corrections, improvements, modifications and other changes to this product at anytime. PLE reserves the right to discontinue any product or service without notice. Customers are responsible for obtaining the latest relevant information before placing orders and should verify that such information is current and complete. All products are sold subject to PLE's terms and conditions of sale supplied at the time of order acknowledgment.

PLE warrants performance of this product to the specifications applicable at the time of sale in accordance with PLE's limited warranty. Testing and other quality control techniques are used to the extent PLE deems necessary to support this warranty. Except where mandated by specific contractual documents, testing of all parameters of each product is not necessarily performed.

PLE assumes no liability for application assistance or customer product design. Customers are responsible for their products and applications using PLE components. To minimize the risks associated with the customer products and applications, customers should provide adequate design and operating safeguards.

PLE products are not designed, intended, authorized or warranted to be suitable for use in life support applications, devices or systems or other critical applications that may involve potential risks of death, personal injury or severe property or environmental damage. Inclusion of PLE products in such applications is understood to be fully at the risk of the customer. Use of PLE products in such applications requires the written approval of an appropriate PLE officer. Questions concerning potential risk applications should be directed to PLE.

PLE does not warrant or represent that any license, either express or implied, is granted under any PLE patent right, copyright, artwork or other intellectual property right relating to any combination, machine or process which PLE product or services are used. Information published by PLE regarding third-party products or services does not constitute a license from PLE to use such products or services or a warranty or endorsement thereof. Use of such information may require a license from a third party under the patents or other intellectual property of the third party, or a license from PLE under the patents or other intellectual property of PLE.

Reproduction of information in PLE data sheets or web site is permissible only if the reproduction is without alteration and is accompanied by associated warranties, conditions, limitations and notices. Reproduction of this information with alteration is an unfair and deceptive business practice. PLE is not responsible or liable for such altered documents.

Resale of PLE products or services with statements different from or beyond the parameters stated by PLE for that product or service voids all express and implied warranties for the associated PLE product or service and is an unfair or deceptive business practice. PLE is not responsible for any such statements.

Contacting Pletronics Inc.

Pletronics Inc.
19013 36th Ave. West
Lynnwood, WA 98036-5761 USA

Tel: 425-776-1880
Fax: 425-776-2760
E-mail: ple-sales@pletronics.com
URL: www.pletronics.com

Copyright © 2010, Pletronics Inc.



Стандарт Электрон Связь

Мы молодая и активно развивающаяся компания в области поставок электронных компонентов. Мы поставляем электронные компоненты отечественного и импортного производства напрямую от производителей и с крупнейших складов мира.

Благодаря сотрудничеству с мировыми поставщиками мы осуществляем комплексные и плановые поставки широчайшего спектра электронных компонентов.

Собственная эффективная логистика и склад в обеспечивает надежную поставку продукции в точно указанные сроки по всей России.

Мы осуществляем техническую поддержку нашим клиентам и предпродажную проверку качества продукции. На все поставляемые продукты мы предоставляем гарантию .

Осуществляем поставки продукции под контролем ВП МО РФ на предприятия военно-промышленного комплекса России , а также работаем в рамках 275 ФЗ с открытием отдельных счетов в уполномоченном банке. Система менеджмента качества компании соответствует требованиям ГОСТ ISO 9001.

Минимальные сроки поставки, гибкие цены, неограниченный ассортимент и индивидуальный подход к клиентам являются основой для выстраивания долгосрочного и эффективного сотрудничества с предприятиями радиоэлектронной промышленности, предприятиями ВПК и научно-исследовательскими институтами России.

С нами вы становитесь еще успешнее!

Наши контакты:

Телефон: +7 812 627 14 35

Электронная почта: sales@st-electron.ru

Адрес: 198099, Санкт-Петербург,
Промышленная ул, дом № 19, литера Н,
помещение 100-Н Офис 331