

Features

- Epitaxial Planar Die Construction
- Low Collector-Emitter Saturation Resistance $R_{CE(SAT)} = 75m\Omega$ at 4A
- Complementary PNP Type Available (2DB1386)
- Ideally Suited for Automated Assembly Processes
- Ideal for Medium Power Switching or Amplification Applications
- **Lead Free By Design/RoHS Compliant (Note 1)**
- **"Green" Device (Note 2)**



SOT89-3L

Mechanical Data

- Case: SOT89-3L
- Case Material: Molded Plastic, "Green" Molding Compound. UL Flammability Classification Rating 94V-0
- Moisture Sensitivity: Level 1 per J-STD-020D
- Terminals: Finish — Matte Tin annealed over Copper leadframe (Lead Free Plating). Solderable per MIL-STD-202, Method 208
- Marking Information: See Page 3
- Ordering Information: See Page 3
- Weight: 0.072 grams (approximate)

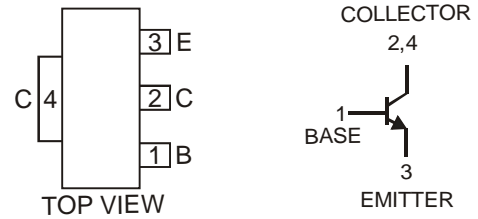

Schematic and Pin Configuration

Maximum Ratings @ $T_A = 25^\circ C$ unless otherwise specified

| Characteristic | Symbol | Value | Unit |
|------------------------------|-----------|-------|------|
| Collector-Base Voltage | V_{CBO} | 50 | V |
| Collector-Emitter Voltage | V_{CEO} | 20 | V |
| Emitter-Base Voltage | V_{EBO} | 6 | V |
| Peak Pulse Current | I_{CM} | 10 | A |
| Continuous Collector Current | I_C | 5 | A |

Thermal Characteristics

| Characteristic | Symbol | Value | Unit |
|---|-----------------|-------------|--------------|
| Power Dissipation (Note 3) @ $T_A = 25^\circ C$ | P_D | 1 | W |
| Thermal Resistance, Junction to Ambient Air (Note 3) @ $T_A = 25^\circ C$ | $R_{\theta JA}$ | 125 | $^\circ C/W$ |
| Operating and Storage Temperature Range | T_J, T_{STG} | -55 to +150 | $^\circ C$ |

Electrical Characteristics @ $T_A = 25^\circ C$ unless otherwise specified

| Characteristic | Symbol | Min | Typ | Max | Unit | Conditions |
|--------------------------------------|---------------|-----|-----|-----|---------|--|
| OFF CHARACTERISTICS (Note 4) | | | | | | |
| Collector-Base Breakdown Voltage | $V_{(BR)CBO}$ | 50 | — | — | V | $I_C = 50\mu A, I_E = 0$ |
| Collector-Emitter Breakdown Voltage | $V_{(BR)CEO}$ | 20 | — | — | V | $I_C = 1mA, I_B = 0$ |
| Emitter-Base Breakdown Voltage | $V_{(BR)EBO}$ | 6 | — | — | V | $I_E = 50\mu A, I_C = 0$ |
| Collector Cut-Off Current | I_{CBO} | — | — | 0.5 | μA | $V_{CB} = 40V, I_E = 0$ |
| Emitter Cut-Off Current | I_{EBO} | — | — | 0.5 | μA | $V_{EB} = 5V, I_C = 0$ |
| ON CHARACTERISTICS (Note 4) | | | | | | |
| Collector-Emitter Saturation Voltage | $V_{CE(SAT)}$ | — | 0.3 | 1.0 | V | $I_C = 4A, I_B = 0.1A$ |
| DC Current Gain | h_{FE} | 180 | — | 390 | — | $I_C = 0.5A, V_{CE} = 2V$ |
| SMALL SIGNAL CHARACTERISTICS | | | | | | |
| Transition Frequency | f_T | — | 220 | — | MHz | $V_{CE} = 6V, I_E = -50mA, f = 100MHz$ |
| Output Capacitance | C_{ob} | — | 14 | — | pF | $V_{CB} = 20V, I_E = 0, f = 1MHz$ |

- Notes:
1. No purposefully added lead.
 2. Diodes Inc.'s "Green" policy can be found on our website at http://www.diodes.com/products/lead_free/index.php.
 3. Device mounted on FR-4 PCB; pad layout as shown on page 4 or in Diodes Inc. suggested pad layout document AP02001, which can be found on our website at <http://www.diodes.com/datasheets/ap02001.pdf>.
 4. Measured under pulsed conditions. Pulse width = 300 μs . Duty cycle $\leq 2\%$.

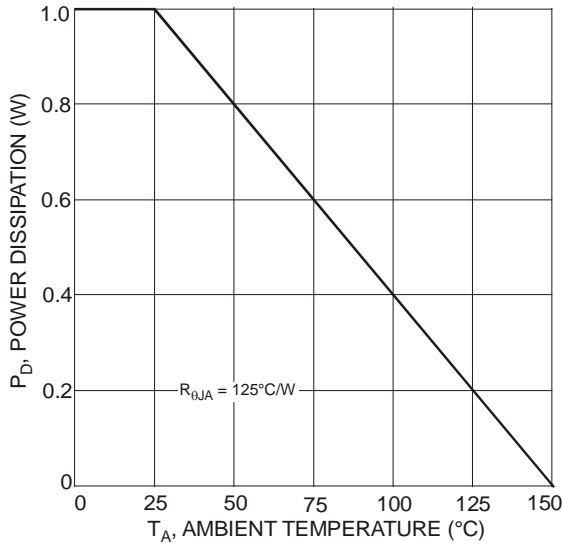

Fig. 1 Power Dissipation vs. Ambient Temperature (Note 3)

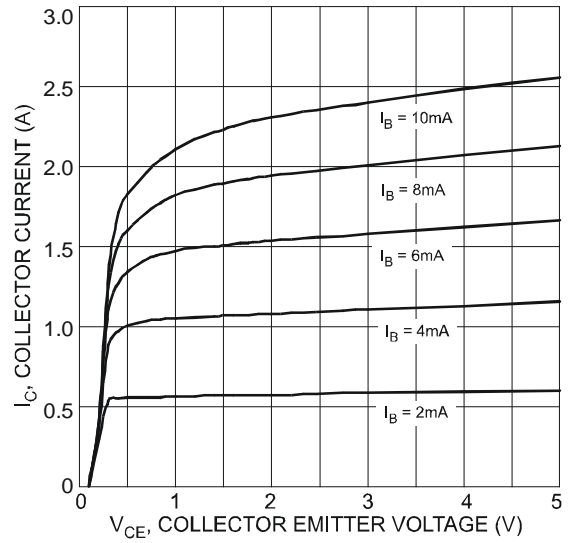

Fig. 2 Typical Collector Current vs. Collector-Emitter Voltage

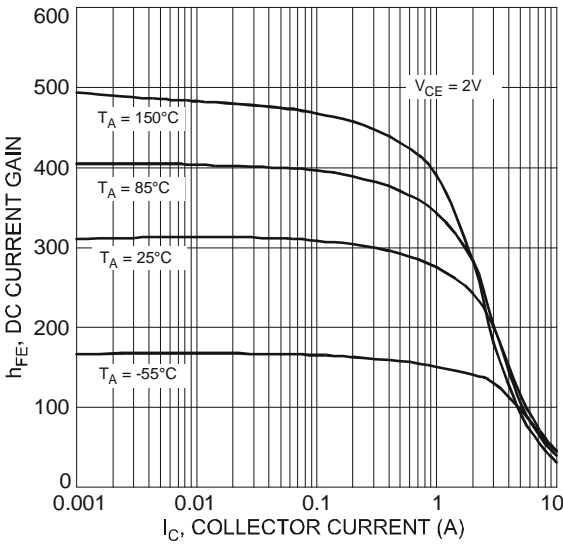

Fig. 3 Typical DC Current Gain vs. Collector Current

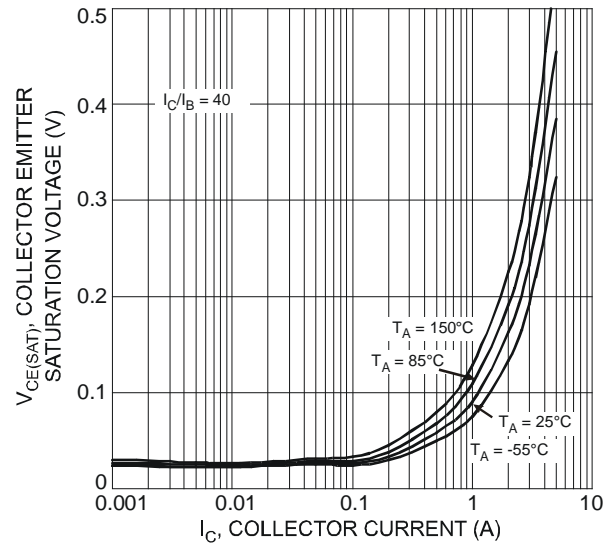

Fig. 4 Typical Collector-Emitter Saturation Voltage vs. Collector Current

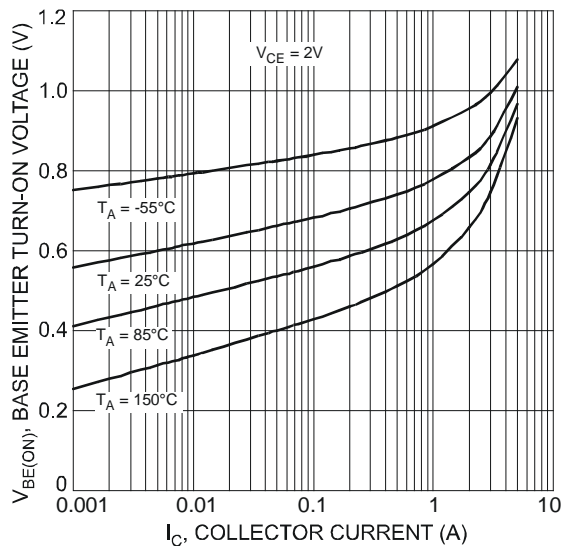

Fig. 5 Typical Base-Emitter Turn-On Voltage vs. Collector Current

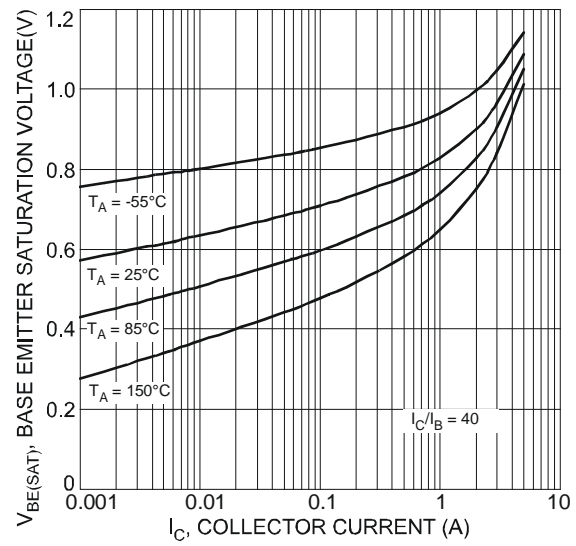

Fig. 6 Typical Base-Emitter Saturation Voltage vs. Collector Current

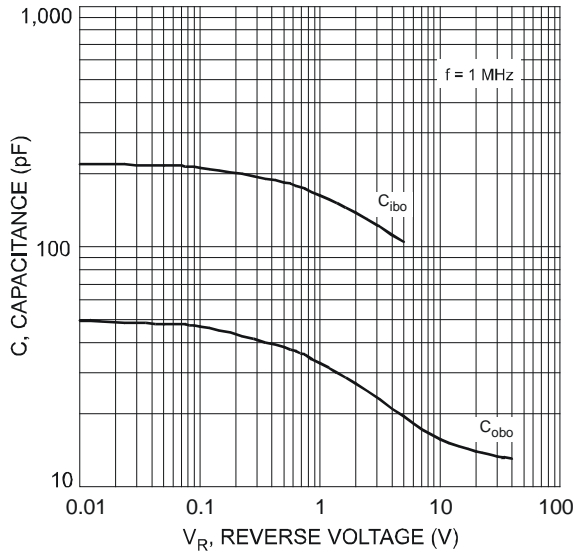

Fig. 7 Typical Junction Capacitance Characteristics

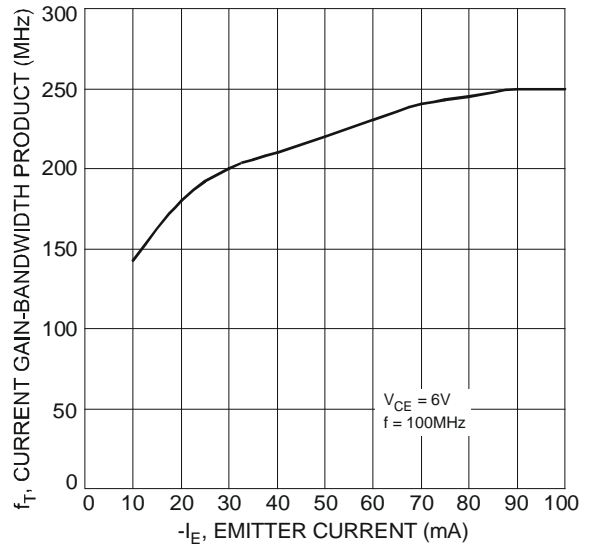

Fig. 8 Typical Gain-Bandwidth Product vs. Emitter Current

Ordering Information (Note 5)

| Device | Packaging | Shipping |
|-------------|-----------|------------------|
| 2DD2098R-13 | SOT89-3L | 2500/Tape & Reel |

Notes: 5. For packaging details, please see below or go to our website at <http://www.diodes.com/ap02007.pdf>.

Marking Information

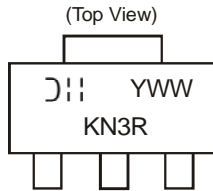

KN3R = Product Type Marking Code
 DII = Manufacturer's Marking Code
 YWW = Date Code Marking
 Y = Last digit of year ex: 7 = 2007
 WW = Week code 01 - 52

Package Outline Dimensions

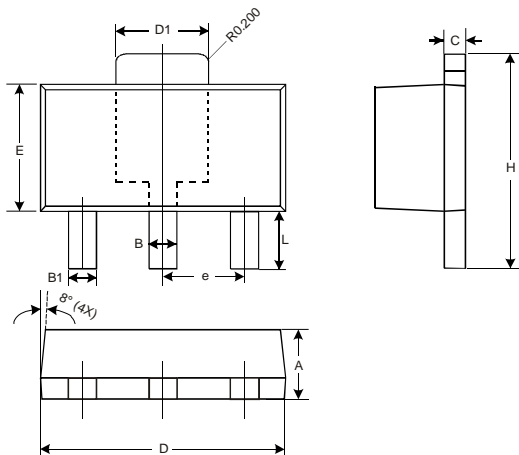

| SOT89-3L | | | |
|----------------------|------|------|------|
| Dim | Min | Max | Typ |
| A | 1.40 | 1.60 | 1.50 |
| B | 0.45 | 0.55 | 0.50 |
| B1 | 0.37 | 0.47 | 0.42 |
| C | 0.35 | 0.43 | 0.38 |
| D | 4.40 | 4.60 | 4.50 |
| D1 | 1.50 | 1.70 | 1.60 |
| E | 2.40 | 2.60 | 2.50 |
| e | — | — | 1.50 |
| H | 3.95 | 4.25 | 4.10 |
| L | 0.90 | 1.20 | 1.05 |
| All Dimensions in mm | | | |

Suggested Pad Layout

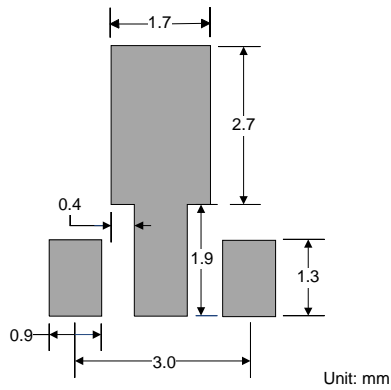

IMPORTANT NOTICE

Diodes Incorporated and its subsidiaries reserve the right to make modifications, enhancements, improvements, corrections or other changes without further notice to any product herein. Diodes Incorporated does not assume any liability arising out of the application or use of any product described herein; neither does it convey any license under its patent rights, nor the rights of others. The user of products in such applications shall assume all risks of such use and will agree to hold Diodes Incorporated and all the companies whose products are represented on our website, harmless against all damages.

LIFE SUPPORT

Diodes Incorporated products are not authorized for use as critical components in life support devices or systems without the expressed written approval of the President of Diodes Incorporated.



Стандарт Электрон Связь

Мы молодая и активно развивающаяся компания в области поставок электронных компонентов. Мы поставляем электронные компоненты отечественного и импортного производства напрямую от производителей и с крупнейших складов мира.

Благодаря сотрудничеству с мировыми поставщиками мы осуществляем комплексные и плановые поставки широчайшего спектра электронных компонентов.

Собственная эффективная логистика и склад в обеспечивает надежную поставку продукции в точно указанные сроки по всей России.

Мы осуществляем техническую поддержку нашим клиентам и предпродажную проверку качества продукции. На все поставляемые продукты мы предоставляем гарантию .

Осуществляем поставки продукции под контролем ВП МО РФ на предприятия военно-промышленного комплекса России , а также работаем в рамках 275 ФЗ с открытием отдельных счетов в уполномоченном банке. Система менеджмента качества компании соответствует требованиям ГОСТ ISO 9001.

Минимальные сроки поставки, гибкие цены, неограниченный ассортимент и индивидуальный подход к клиентам являются основой для выстраивания долгосрочного и эффективного сотрудничества с предприятиями радиоэлектронной промышленности, предприятиями ВПК и научно-исследовательскими институтами России.

С нами вы становитесь еще успешнее!

Наши контакты:

Телефон: +7 812 627 14 35

Электронная почта: sales@st-electron.ru

Адрес: 198099, Санкт-Петербург,
Промышленная ул, дом № 19, литера Н,
помещение 100-Н Офис 331