

Analog Sound Processors series

Sound Processor for car audio built-in High-Voltage function and 2nd order post filter

BD37068FV-M

General Description

It is built-in input selector of 6 stereo source and output to ADC after adjusting signal level. And built-in 2nd order post filter to reduce out of band noise and 6ch Volume circuit. It is possible to out until 5.2V_{RMS} at maximum output. (High Voltage function) Moreover, it is simple to design set by built-in TDMA noise reduction systems.

Features

- AEC-Q100 (Grade3) Qualified
- Built-in differential input selector that can select single-ended / differential input
- Reduce the pop noise when switching gain due to built-in advanced switch circuit
- Less out-of-band noise of DAC by built-in 2nd order post filter.
- Built-in buffered ground isolation amplifier to realize high CMRR characteristics
- Built-in TDMA noise reduction circuit reduces the additional components for external filter.
- It is possible to output 5.2V_{RMS} by High-Voltage function
- Package is SSOP-B40. Putting same direction input-terminals and output-terminals make PCB layout easier and PCB area smaller.
- Available to control by 3.3V/5V for I²C-bus controller

Key Specifications^(Note1)

- Total Harmonic Distortion : 0.003%(Typ)
- Maximum Input Voltage : 2.2V_{RMS}(Typ)
- Common Mode Rejection Ratio : 55dB(Min)
- Maximum Output Voltage : 5.2V_{RMS}(Typ)
- Output Noise Voltage : 23μV_{RMS}(Typ)
- Residual Output Noise Voltage : 10.5μV_{RMS}(Typ)
- Ripple Rejection: -70dB (Typ)
- Operating Temperature Range: -40°C to +85°C

(Note1) These specifications are condition of High-Voltage ON.

Package
SSOP-B40

W(Typ) x D(Typ) x H(Max)
13.60mm x 7.80mm x 2.00mm

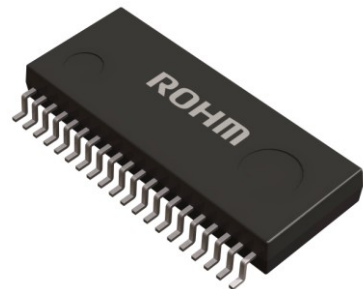

SSOP-B40

Applications

It is the optimal for the car audio. Besides, it is possible to use for the audio equipment of mini Compo, micro Compo.

Typical Application Circuit

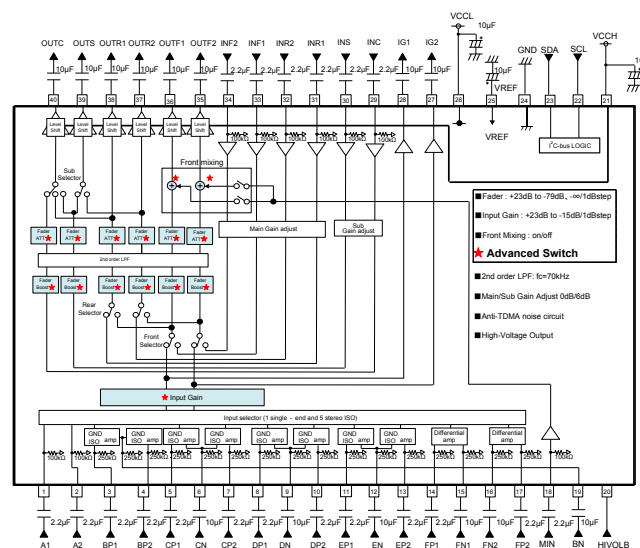

Figure 1. Typical Application Circuit

○Product structure : Silicon monolithic integrated circuit ○This product is not designed protection against radioactive rays.

Contents

General Description 1

Features 1

Applications 1

Key Specifications ^(Note1) 1

Package W(Typ) x D(Typ) x H(Max) 1

Typical Application Circuit 1

Contents 2

Pin Configuration 3

Pin Descriptions 3

Block Diagram 4

Absolute Maximum Ratings (Ta=25°C) 4

Operating Range 4

Electrical Characteristic 5

Typical Performance Curve(s) 7

I²C-bus Control Signal Specification 9

1. Electrical specifications and timing for bus lines and I/O stages 9

2. I²C-bus Format 10

3. I²C-bus Interface Protocol 10

4. Slave Address 10

5. Select Address & Data 11

6. About power on reset 17

7. About start-up and power off sequence on IC 17

Fader Volume Attenuation of the Detail 18

About bias voltage of output terminal(27,28,35 to 40pin) vs. VCC 19

About Advanced Switch Circuit 20

Application Circuit Diagram 26

Thermal Derating Curve 27

I/O Equivalence Circuit 28

Application Information 30

1. Absolute maximum rating voltage 30

2. About a signal input part 30

3. About output load characteristics 30

4. About HIVOLB terminal(20pin) when power supply is off 31

5. About signal input terminals 31

6. About changing gain of Input Gain and Fader Volume 31

7. About inter-pin short to VCCH 31

Operational Notes 32

1. Reverse Connection of Power Supply 32

2. Power Supply Lines 32

3. Ground Voltage 32

4. Ground Wiring Pattern 32

5. Thermal Consideration 32

6. Recommended Operating Conditions 32

7. Inrush Current 32

8. Operation Under Strong Electromagnetic Field 32

9. Testing on Application Boards 32

10. Inter-pin Short and Mounting Errors 33

11. Regarding the Input Pin of the IC 33

Ordering Name Selection 34

Physical Dimension Tape and Reel Information 34

Marking Diagram 34

Revision History 35

Pin Configuration

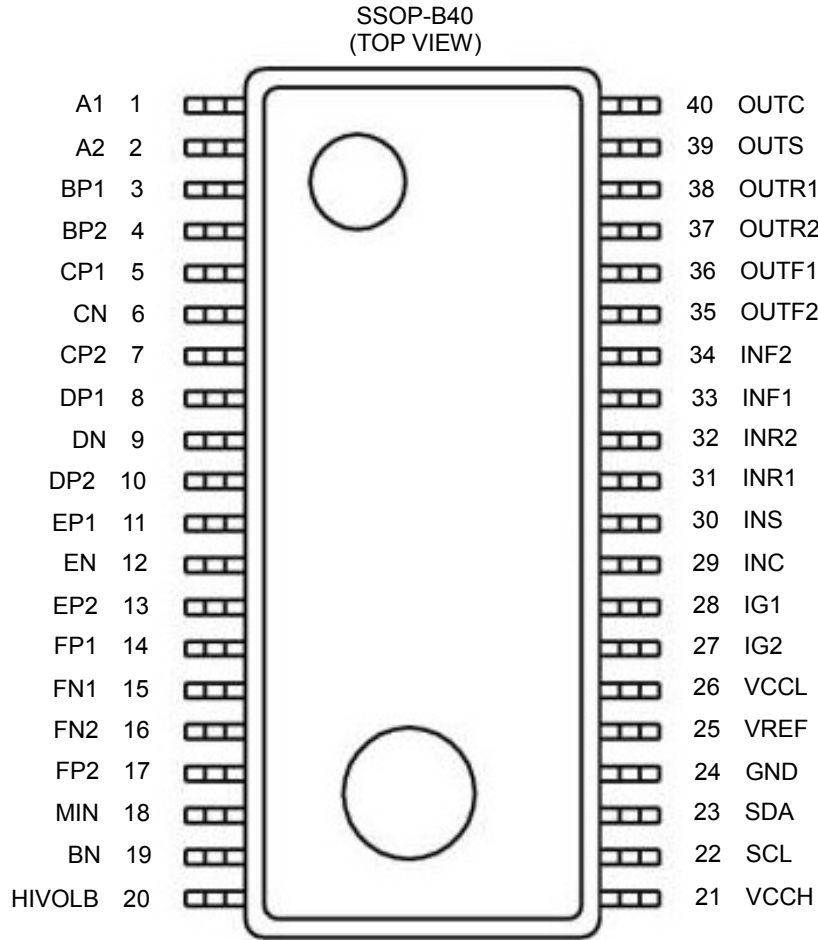

Figure 2. Pin configuration

Pin Descriptions

Pin No.	Pin Name	Description	Pin No.	Pin Name	Description
1	A1	A input terminal of 1ch	21	VCCH	VCCH terminal for power supply
2	A2	A input terminal of 2ch	22	SCL	I ² C Communication clock terminal
3	BP1	B positive input terminal of 1ch	23	SDA	I ² C Communication data terminal
4	BP2	B positive input terminal of 2ch	24	GND	GND terminal
5	CP1	C positive input terminal of 1ch	25	VREF	BIAS terminal
6	CN	C negative input terminal	26	VCCL	VCCL terminal for power supply
7	CP2	C positive input terminal of 2ch	27	IG2	Input Gain output terminal of 2ch
8	DP1	D positive input terminal of 1ch	28	IG1	Input Gain output terminal of 1ch
9	DN	D negative input terminal	29	INC	Center input terminal
10	DP2	D positive input terminal of 2ch	30	INS	Subwoofer input terminal
11	EP1	E positive input terminal of 1ch	31	INR1	Rear input terminal of 1ch
12	EN	E negative input terminal	32	INR2	Rear input terminal of 2ch
13	EP2	E positive input terminal of 2ch	33	INF1	Front input terminal of 1ch
14	FP1	F positive input terminal of 1ch	34	INF2	Front input terminal of 2ch
15	FN1	F negative input terminal of 1ch	35	OUTF2	Front output terminal of 2ch
16	FN2	F negative input terminal of 2ch	36	OUTF1	Front output terminal of 1ch
17	FP2	F positive input terminal of 2ch	37	OUTR2	Rear output terminal of 2ch
18	MIN	Mixing input terminal	38	OUTR1	Rear output terminal of 1ch
19	BN	B negative input terminal	39	OUTS	Subwoofer output terminal
20	HIVALB	Output Gain control terminal	40	OUTC	Center output terminal

Block Diagram

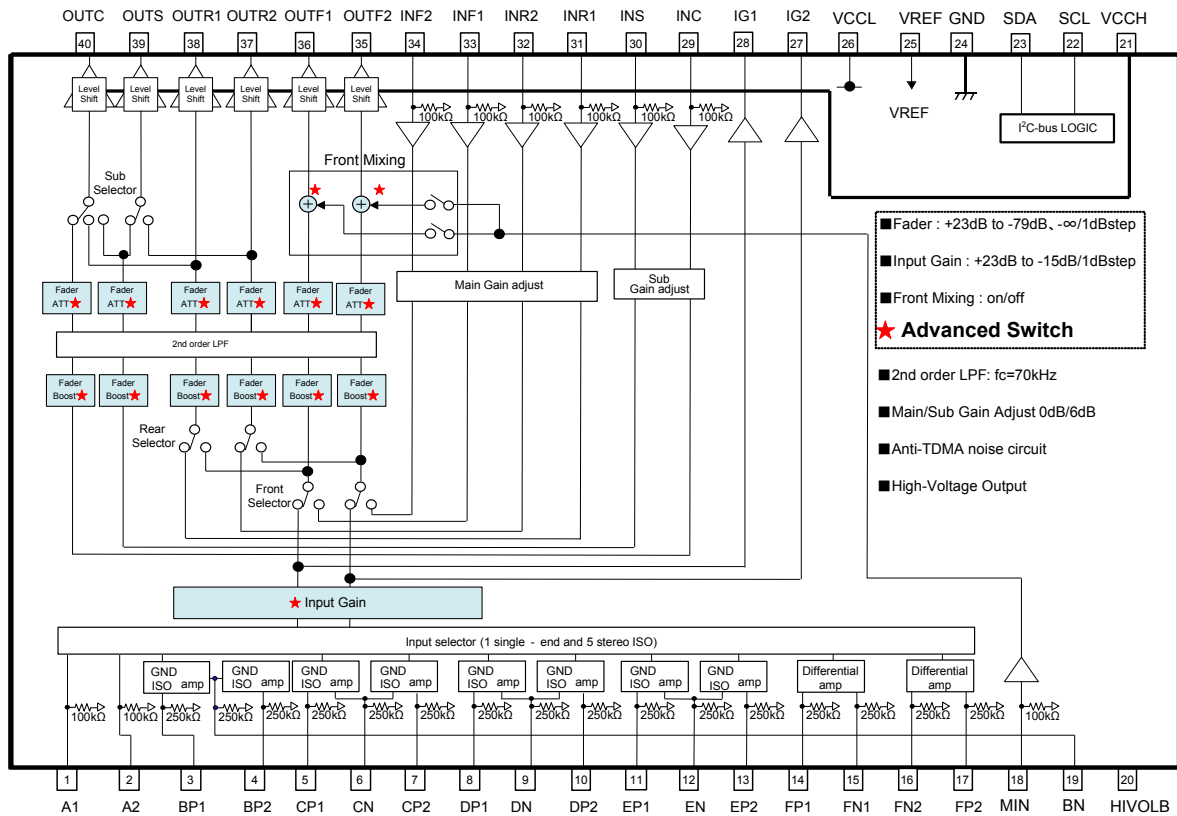

Figure 3. Block diagram and pin assign

Absolute Maximum Ratings (Ta=25°C)

Parameter	Symbol	Rating	Unit
Power Supply Voltage	VCCL	10	V
	VCCH	18	V
Input Voltage	V _{IN}	VCCL+0.3 to GND-0.3 Only SCL, SDA 7 to GND-0.3	V
Power Dissipation	P _d	1.12 ^(Note1)	W
Storage Temperature	T _{STG}	-55 to +150	°C

(Note1) This value decreases 9mW/°C for Ta=25°C or more.
 ROHM standard board shall be mounted. Thermal resistance θ_{ja} = 111.1(°C/W).
 ROHM Standard board size : 70x70x1.6(mm)
 material : A FR4 grass epoxy board(3% or less of copper foil area)

Operating Range

Parameter	Symbol	Min	Typ	Max	Unit
Power Supply Voltage	VCCL	7.0	8.5	9.5	V
	VCCH	VCCL	17	17.8	V
Temperature	Topr	-40	-	+85	°C

Electrical Characteristic

(Unless specified particularly, Ta=25°C, VCCL=8.5V, VCCH=17.0V, f=1kHz, VIN=1VRMS, RG=600Ω, RL=10kΩ, A input, Input Gain 0dB, Gain Adjust +6dB, High-Voltage ON, LPF ON, Fader 0dB, Input point=A1/A2, Monitor point=IG1/IG2)

Block	Parameter	Symbol	Limit			Unit	Conditions
			Min	Typ	Max		
General	Current upon no signal (VCCL)	I _{Q_VCC} L	—	30	43	mA	No signal
	Current upon no signal (VCCH)	I _{Q_VCC} H	-	7	10	mA	No signal
Input Selector	Input Impedance (A)	R _{IN_S}	70	100	130	kΩ	
	Input Impedance (B, C, D, E, F)	R _{IN_D}	175	250	325	kΩ	
	Voltage Gain	G _V	-1.5	+0	+1.5	dB	G _V =20log(V _{OUT} /V _{IN})
	Channel Balance	CB	-1.5	+0	+1.5	dB	CB = G _{V1} -G _{V2}
	Total Harmonic Distortion	THD+N	—	0.003	0.05	%	V _{OUT} =1V _{RMS} BW=400-30kHz
	Output Noise Voltage ^(Note1)	V _{NO1}	—	3.1	8.0	μV _{RMS}	R _G = 0Ω BW = IHF-A
	Maximum Input Voltage	V _{IM}	2.0	2.2	—	V _{RMS}	V _{IM} at THD+N(V _{OUT})=1% BW=400-30kHz
	Crosstalk Between Channels ^(Note1)	CTC	—	-100	-90	dB	R _G = 0Ω CTC=20log(V _{OUT} /V _{OUT'}) BW = IHF-A
	Crosstalk Between Selectors ^(Note1)	CTS	—	-100	-90	dB	R _G = 0Ω CTS=20log(V _{OUT} /V _{OUT'}) BW = IHF-A
Common Mode Rejection Ratio (B, C, D, E, F) ^(Note1)	CMRR	55	65	—	dB	XP1 and XN input XP2 and XN input CMRR=20log(V _{IN} /V _{OUT}) BW = IHF-A, [X=B,C,D,E,F]	
Input Gain	Minimum Input Gain	G _{IN MIN}	-17	-15	-13	dB	Input gain -15dB G _{IN} =20log(V _{OUT} /V _{IN})
	Maximum Input Gain	G _{IN MAX}	21	23	25	dB	Input gain 23dB V _{IN} =100mV _{RMS} G _{IN} =20log(V _{OUT} /V _{IN})
	Gain Set Error	G _{IN ERR}	-2	+0	+2	dB	GAIN=-15 to +23dB
	Output Impedance	R _{OUT}	-	—	50	Ω	V _{IN} =100mV _{RMS}
	Maximum Output Voltage	V _{OM}	2.0	2.2	—	V _{RMS}	THD+N=1% BW=400-30kHz

(Note1) VP-9690A (Average value detection, effective value display) filter by Panasonic is used for measurement. Input and output are in-phase.

(Unless specified particularly, Ta=25°C, VCCL=8.5V, VCCH=17.0V, f=1kHz, VIN=0.9VRMS, RG=600Ω, RL=10kΩ, A input, Input Gain 0dB, Gain Adjust +6dB, High-Voltage ON, LPF ON, Fader 0dB, Input point=INF1/INF2/INR1/INR2/INC/INS, Monitor point=OUTF1/OUTF2/OUTR1/OUTR2/OUTC/OUTS)

Block	Parameter	Symbol	Limit			Unit	Conditions
			Min	Typ	Max		
Output	Output Impedance	R _{OUT}	-	—	50	Ω	V _{IN} =100mV _{RMS}
	Maximum Output Voltage	V _{OM}	5.1	5.2	—	V _{RMS}	V _{IN} =1V _{RMS} THD+N=1% BW=400-30kHz
	Maximum Output Gain	G _{Hout}	6.3	8.3	10.3	dB	G _{Hout} =20log(V _{OUT} /V _{IN})

(Unless specified particularly, Ta=25°C, VCCL=8.5V, VCCH=17.0V, f=1kHz, VIN=0.9VRMS, RG=600Ω, RL=10kΩ, A input, Input Gain 0dB, Gain Adjust +6dB, High-Voltage ON, LPF ON, Fader 0dB, Input point=INF1/INF2/INR1/INR2/INC/INS, Monitor point=OUTF1/OUTF2/OUTR1/OUTR2/OUTC/OUTS)

Block	Parameter	Symbol	Limit			Unit	Conditions
			Min	Typ	Max		
Fader	Maximum Boost Gain	G _{F BST}	21	23	25	dB	Gain=23dB V _{IN} =100mV _{RMS} G _F =20log(V _{OUT} /V _{IN})-G _{Hout} Gain Adjust=0dB
	Channel Balance	CB	-1.5	+0	+1.5	dB	CB = G _{V1} -G _{V2}
	Total Harmonic Distortion	THD+N	—	0.003	0.05	%	BW=400-30kHz
	Output Noise Voltage ^(Note1)	V _{NO1}	—	23	40	μV _{RMS}	R _G = 0Ω BW = IHF-A
	Residual Output Noise Voltage ^(Note1)	V _{NOR}	—	10.5	20	μV _{RMS}	Fader = -∞dB R _G = 0Ω BW = IHF-A
	Maximum Input Voltage	V _{IM}	2.0	2.1	—	V _{RMS}	V _{IM} at THD+N(V _{OUT})=1% BW=400-30kHz Gain Adjust = 0dB
	Crosstalk Between Channels ^(Note1)	CTC	—	-100	-90	dB	R _G = 0Ω CTC=20log(V _{OUT} /V _{OUT'}) BW = IHF-A
	Maximum Attenuation ^(Note1)	G _{F MIN}	—	-100	-90	dB	Fader = -∞dB G _F =20log(V _{OUT} /V _{IN}) BW = IHF-A
	Gain Set Error	G _{F ERR}	-2	+0	+2	dB	Gain=+1 to +23dB
	Attenuation Set Error 1	G _{F ERR1}	-2	+0	+2	dB	Attenuation=0 to -15dB
	Attenuation Set Error 2	G _{F ERR2}	-3	+0	+3	dB	Attenuation=-16 to -47dB
	Attenuation Set Error 3	G _{F ERR3}	-4	+0	+4	dB	Attenuation=-48 to -79dB
Ripple Rejection	PSRR _{VCCL}	—	-70	-40	dB	f=1kHz V _{PSRL} =100mV _{RMS} PSRR _{VCCL} =20log(V _{OUT} /VCCL)	
	PSRR _{VCCH}	—	-70	-40	dB	f=1kHz V _{PSRH} =100mV _{RMS} PSRR _{VCCH} =20log(V _{OUT} /VCCH)	
Mixing	Input Impedance	R _{IN_M}	70	100	130	kΩ	
	Maximum Input voltage	V _{IM_M}	2.0	2.2	-	V _{RMS}	V _{IM} at THD+N(V _{OUT})=1% BW=400-30kHz MIN input
	Maximum Attenuation ^(Note1)	G _{MX MIN}	-	-100	-85	dB	Front Mixing OFF G _{MX} =20log(V _{OUT} /V _{IN}) BW=IHF-A MIN input
	Mixing Gain	G _{MX}	-2	+0	+2	dB	Front Mixing ON G _{MX} =20log(V _{OUT} /V _{IN})-G _{Hout}
Gain Adjust	Input Impedance	R _{IN_M}	70	100	130	kΩ	
	Boost Gain	G _{F BST}	4	6	8	dB	Gain=6dB V _{IN} =100mV _{RMS} G _F =20log(V _{OUT} /V _{IN})-G _{Hout}
	Channel Balance	CB	-1.5	+0	+1.5	dB	CB = G _{V1} -G _{V2}

(Note1) VP-9690A (Average value detection, effective value display) filter by Panasonic is used for measurement. Input and output are in-phase.

Typical Performance Curve(s)

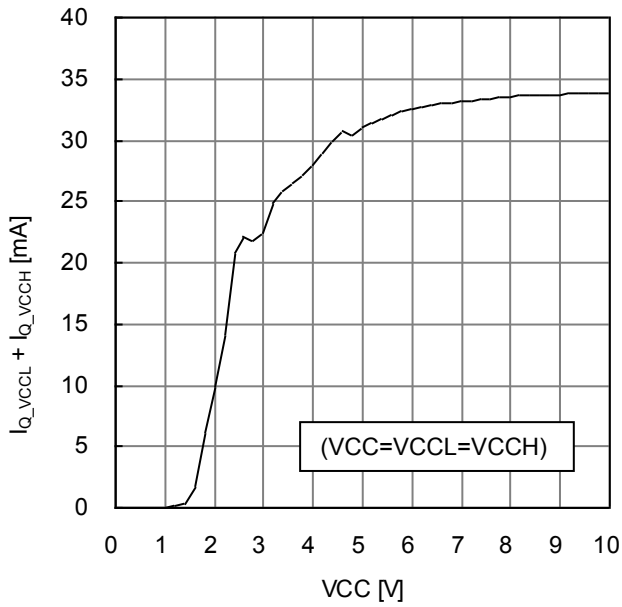

Figure 4. $I_{Q_VCCCL}+I_{Q_VCCH}$ vs VCC

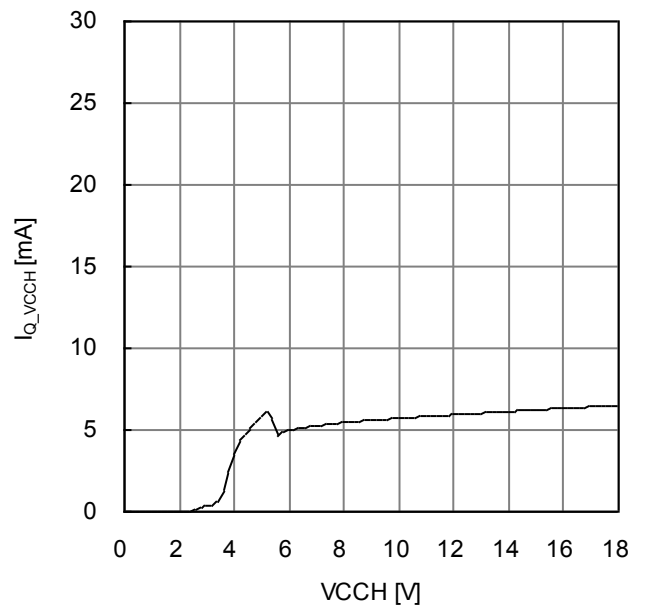

Figure 5. I_{Q_VCCH} vs VCCH (High-Voltage ON)

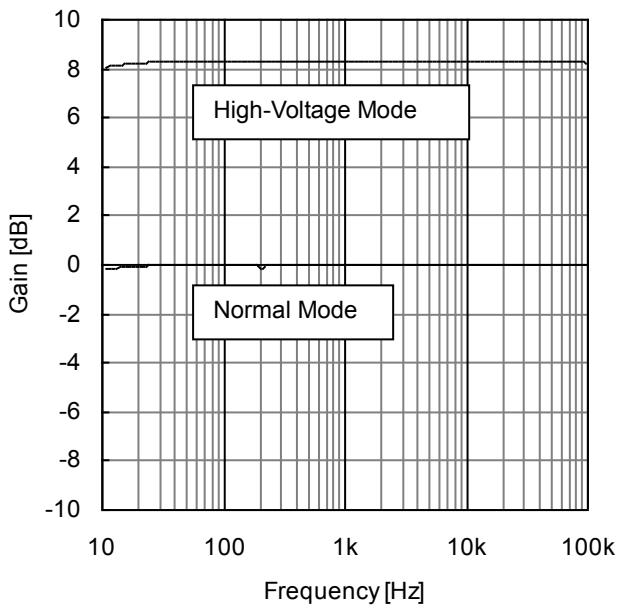

Figure 6. Gain vs Frequency (Normal / High-Voltage mode)

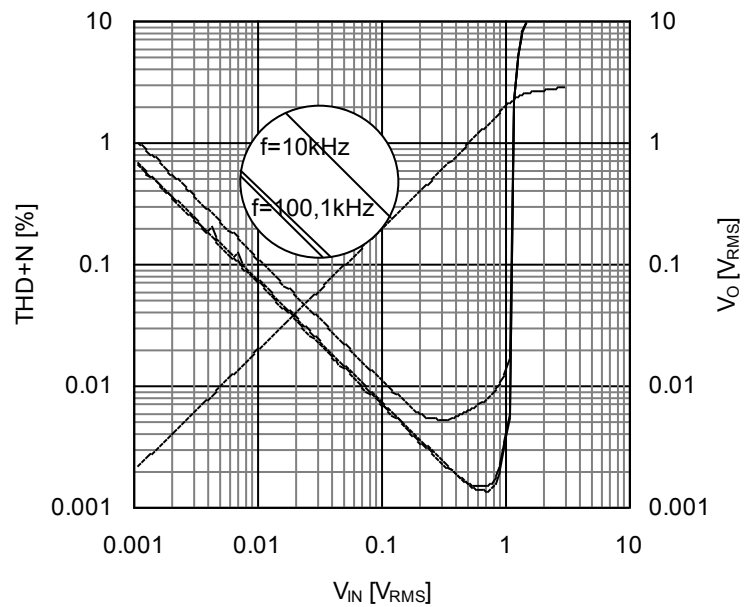

Figure 7. THD+N, V_O vs V_{IN} (Gain Adjust=+6dB)

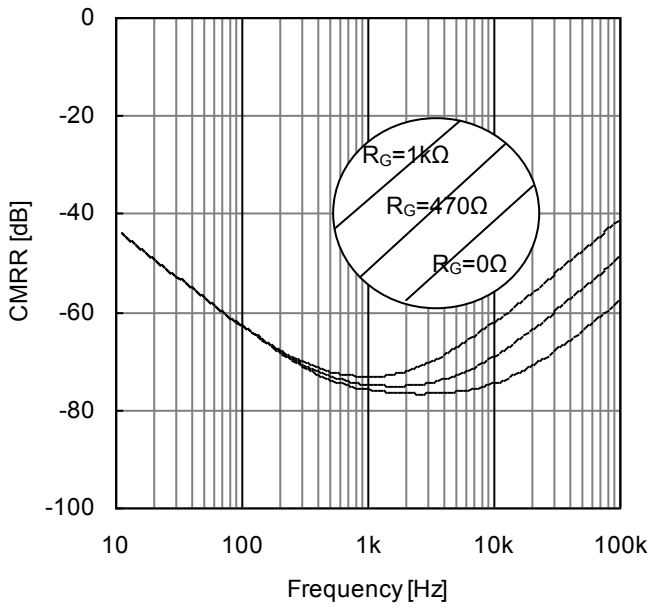

Figure 8. CMRR vs Frequency

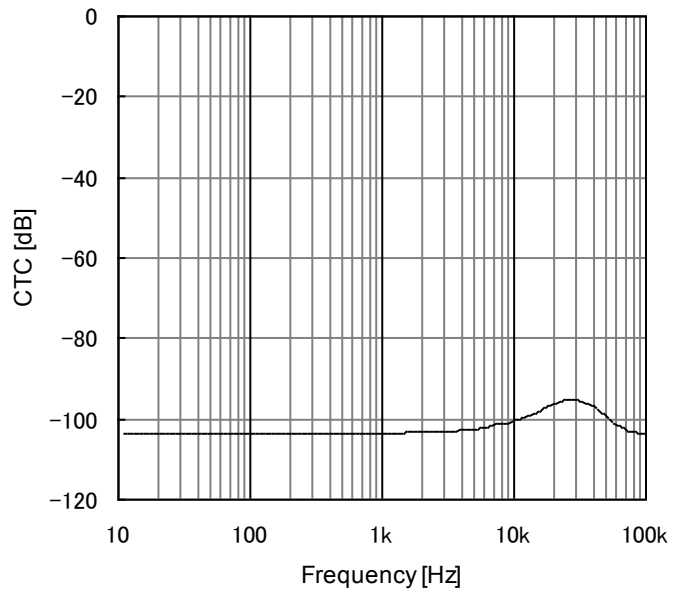

Figure 9. CTC vs Frequency

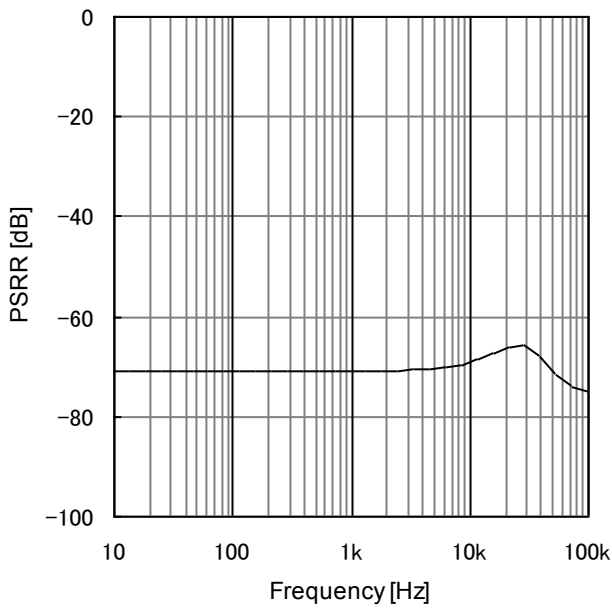

Figure 10. PSRR vs Frequency

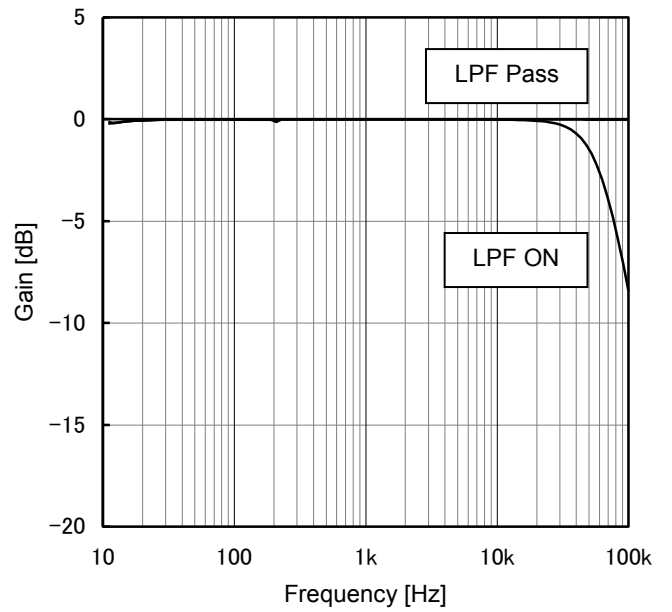

Figure 11. Gain vs Frequency (LPF ON/Pass)

I²C-bus Control Signal Specification

1. Electrical specifications and timing for bus lines and I/O stages

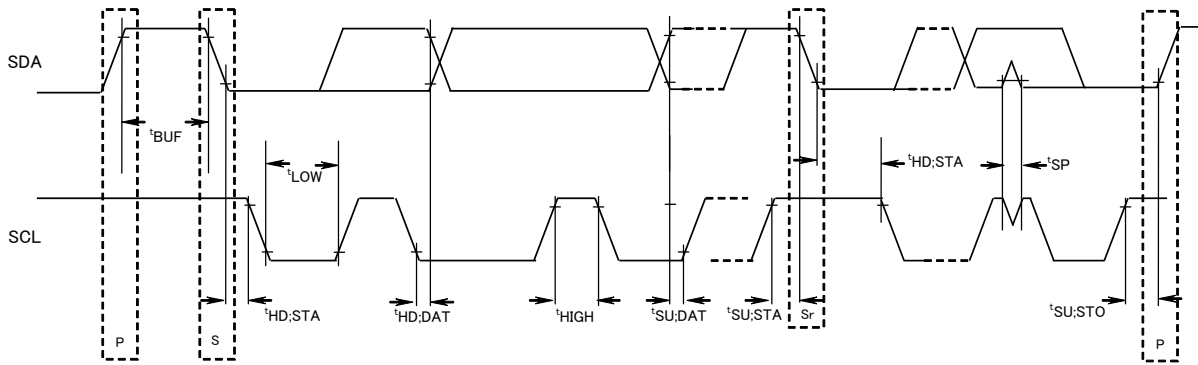

Figure 12. Definition of timing on the I²C-bus

Table 1 Characteristics of the SDA and SCL bus lines for I²C-bus devices

Parameter	Symbol	Fast-mode I ² C-bus		Unit
		Min	Max	
1 SCL Clock Frequency	fSCL	0	400	kHz
2 Bus Free time between a STOP and START condition	tBUF	1.3	—	μsec
3 Hold Time (repeated) START condition. After this period, the first clock pulse is generated	tHD;STA	0.6	—	μsec
4 LOW Period of the SCL Clock	tLOW	1.3	—	μsec
5 HIGH Period of the SCL Clock	tHIGH	0.6	—	μsec
6 Set-up time for a Repeated START Condition	tSU;STA	0.6	—	μsec
7 Data Hold Time	tHD;DAT	0*	—	μsec
8 Data set-up Time	tSU;DAT	100	—	nsec
9 Set-up Time for STOP Condition	tSU;STO	0.6	—	μsec

All values referred to VIH min. and VIL max. Levels (see Table 2).

Table 2 Characteristics of the SDA and SCL I/O stages for I²C-bus devices

Parameter	Symbol	Fast-mode I ² C-bus		Unit
		Min	Max	
10 LOW level input voltage: Fixed input levels	VIL	-0.5	+1	V
11 HIGH level input voltage: Fixed input levels	VIH	2.3	-	V
12 Pulse width of spikes, which must be suppressed by the input filter.	tSP	0	50	nsec
13 LOW level output voltage (open drain or open collector): At 3mA sink current	VOL1	0	0.4	V
14 Input current each I/O pin with an input voltage between 0.4V and 0.9 VDD max.	I _i	-10	+10	μA

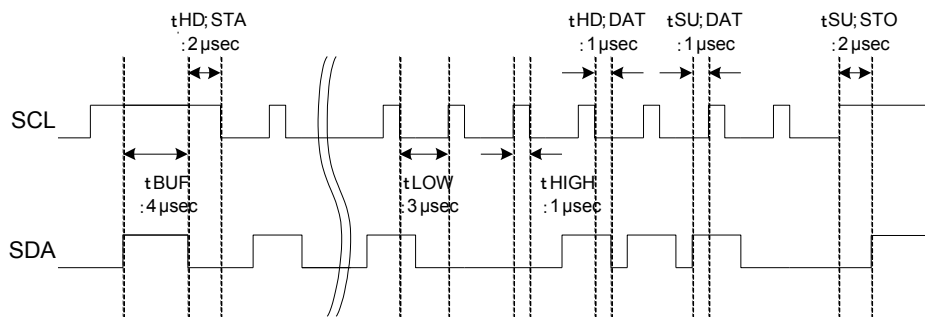

SCL clock frequency: 250kHz

Figure 13. I²C data transmission timing

2. I²C-bus Format

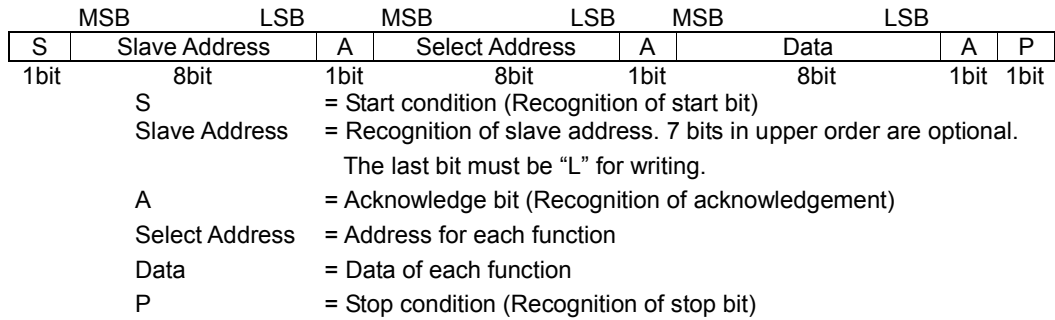

3. I²C-bus Interface Protocol

1) Basic form

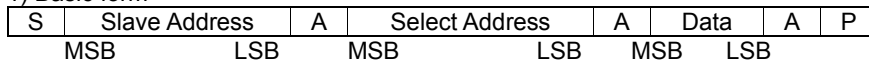

2) Automatic increment(Select Address increases (+1) according to the number of data)

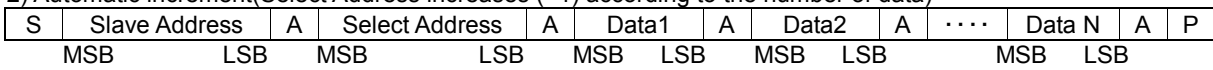

- (Example)①Data 1 shall be set as data of address specified by Select Address.
 ②Data 2 shall be set as data of address specified by Select Address +1.
 ③Data N shall be set as data of address specified by Select Address +(N-1).

3) Configuration unavailable for transmission (In this case, only Select Address 1 is set.)

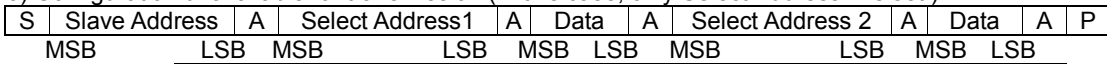

(Note)If any data is transmitted as Select Address 2 next to data, It is recognized as data, not as Select Address 2.

4. Slave Address

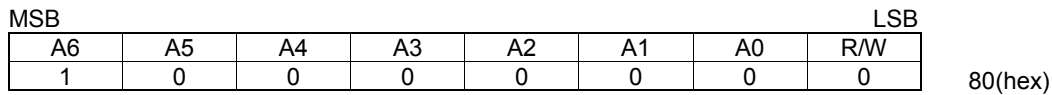

5. Select Address & Data

Items	Select Address (hex)	MSB	Data						LSB
		D7	D6	D5	D4	D3	D2	D1	D0
Initial Setup 1	01	Advanced switch ON/OFF	0	Advanced switch time of Input Gain/Fader		0	0	0	0
Initial Setup 2	02	0	0	Sub Selector		0	0	Rear Selector	Front Selector
Input Selector	05	0	0	0	0	Input Selector			
Input Gain	06	0	0	Input Gain					
Fader 1ch Front	28	Fader Gain / Attenuation							
Fader 2ch Front	29	Fader Gain / Attenuation							
Fader 1ch Rear	2A	Fader Gain / Attenuation							
Fader 2ch Rear	2B	Fader Gain / Attenuation							
Fader Center	2C	Fader Gain / Attenuation							
Fader Subwoofer	2D	Fader Gain / Attenuation							
LPF setup Mixing	30	Front Mixing ON/OFF	LPF fc	0	0	0	0	Sub Gain Adjust	Main Gain Adjust
System Reset	FE	1	0	0	0	0	0	0	1

 Advanced switch

Note) Set up bit (It is written with "0" by the above table) which hasn't been used in "0".

Notes on data format

1. "Advanced switch" function is available for the hatched parts on the above table.
2. In case of transferring data continuously, Select Address (hex) flows by Automatic increment function, as shown below.

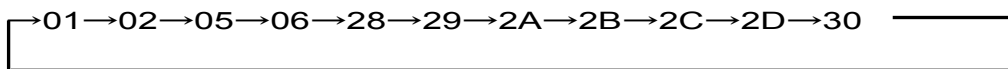

3. Input selector that is not corresponded for "Advanced switch" function, cannot reduce the noise caused when changing the input selector. Therefore, it is recommended to turn on mute when changing these settings.
4. In case of setting to infinite "-∞" by using Fader when input selector setting is changed, please consider "Advanced switch" time.

Select Address 01 (hex)

Mode	Advanced switch time of Input Gain/Fader							LSB
	D7	D6	D5	D4	D3	D2	D1	D0
4.7 msec	Advanced switch ON/OFF	0	0	0	0	0	0	0
7.1 msec			0	1				
11.2 msec			1	0				
14.4 msec			1	1				

Mode	Advanced switch ON/OFF							LSB
	D7	D6	D5	D4	D3	D2	D1	D0
OFF	0	0	Advanced switch time of Input Gain/Fader		0	0	0	0
ON	1		0	0	0	0	0	

Select Address 02 (hex)

Mode	Front Selector							LSB
	D7	D6	D5	D4	D3	D2	D1	D0
FRONT	0	0	Sub Selector		0	0	Rear Selector	0
INSIDE THROUGH			Rear Selector	1				

Mode	Rear Selector							LSB
	D7	D6	D5	D4	D3	D2	D1	D0
REAR	0	0	Sub Selector		0	0	0	Front Selector
FRONT COPY			1					

Mode ^(Note1)	Sub Selector							LSB
	D7	D6	D5	D4	D3	D2	D1	D0
OUTC(INS) OUTS(INS)	0	0	0	0	0	0	Rear Selector	Front Selector
OUTC(INR1) OUTS(INR2)			0	1				
OUTC (INC) OUTS(INS)			1	0				
Prohibition			1	1				

(Note1) xxx(INxx) : "xxx" means "Output terminal", "(INxx)" means "Output signal"

 : Initial condition

Select Address 05(hex)

Mode	MSB		Input Selector				LSB	
	D7	D6	D5	D4	D3	D2	D1	D0
A					0	0	0	0
B single					0	0	0	1
C single					0	0	1	0
D single					0	0	1	1
E single					0	1	0	0
F single					0	1	0	1
C diff	0	0	0	0	0	1	1	0
D diff					0	1	1	1
E diff					1	0	0	0
F full-diff					1	0	0	1
B diff					1	0	1	0
Prohibition					1	0	1	1
					:	:	:	:
					1	1	1	1

: Initial condition

List of active input terminal when set input selector

Mode	Lch positive input terminal	Lch negative input terminal	Rch positive input terminal	Rch negative input terminal
A	1pin(A1)	-	2pin(A2)	-
B single	3pin(BP1)	-	4pin(BP2)	-
C single	5pin(CP1)	-	7pin(CP2)	-
D single	8pin(DP1)	-	10pin(DP2)	-
E single	11pin(EP1)	-	13pin(EP2)	-
F single	14pin(FP1)	-	17pin(FP2)	-
B diff	3pin(BP1)	19pin(BN)	4pin(BP2)	19pin(BN)
C diff	5pin(CP1)	6pin(CN)	7pin(CP2)	6pin(CN)
D diff	8pin(DP1)	9pin(DN)	10pin(DP2)	9pin(DN)
E diff	11pin(EP1)	12pin(EN)	13pin(EP2)	12pin(EN)
F full-diff	14pin(FP1)	15pin(FN1)	17pin(FP2)	16pin(FN2)

[About Ground Isolation Amplifier]

Ground Isolation Amplifier : B diff to E diff

Please select this mode when you use them as a ground isolation amplifier.

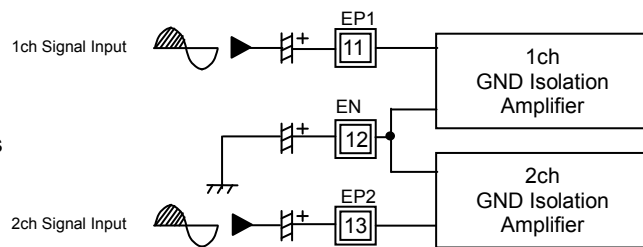

Full Differential Amplifier : F full-diff

Please select this mode when you use it as a differential amplifier

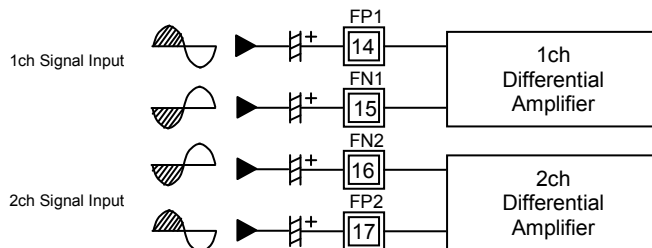

Figure 14. About Ground Isolation Amplifier

Select Address 06 (hex)

Mode	MSB		Input Gain					LSB
	D7	D6	D5	D4	D3	D2	D1	D0
Prohibition	0	0	0	0	0	0	0	0
			:	:	:	:	:	:
0			0	1	0	0	0	
+23dB			0	0	1	0	0	1
+22dB			0	0	1	0	1	0
+21dB			0	0	1	0	1	1
+20dB			0	0	1	1	0	0
+19dB			0	0	1	1	0	1
+18dB			0	0	1	1	1	0
+17dB			0	0	1	1	1	1
+16dB			0	1	0	0	0	0
+15dB			0	1	0	0	0	1
+14dB			0	1	0	0	1	0
+13dB			0	1	0	0	1	1
+12dB			0	1	0	1	0	0
+11dB			0	1	0	1	0	1
+10dB			0	1	0	1	1	0
+9dB			0	1	0	1	1	1
+8dB			0	1	1	0	0	0
+7dB			0	1	1	0	0	1
+6dB			0	1	1	0	1	0
+5dB			0	1	1	0	1	1
+4dB			0	1	1	1	0	0
+3dB			0	1	1	1	0	1
+2dB			0	1	1	1	1	0
+1dB			0	1	1	1	1	1
0dB			1	0	0	0	0	0
-1dB			1	0	0	0	0	1
-2dB			1	0	0	0	1	0
-3dB			1	0	0	0	1	1
-4dB			1	0	0	1	0	0
-5dB			1	0	0	1	0	1
-6dB	1	0	0	1	1	0		
-7dB	1	0	0	1	1	1		
-8dB	1	0	1	0	0	0		
-9dB	1	0	1	0	0	1		
-10dB	1	0	1	0	1	0		
-11dB	1	0	1	0	1	1		
-12dB	1	0	1	1	0	0		
-13dB	1	0	1	1	0	1		
-14dB	1	0	1	1	1	0		
-15dB	1	0	1	1	1	1		
Prohibition	1	1	0	0	0	0		
	:	:	:	:	:	:		
	1	1	1	1	1	1		

: Initial condition

Select Address 28, 29, 2A, 2B, 2C, 2D (hex)

Gain & ATT	MSB		Fader Gain / Attenuation					LSB	
	D7	D6	D5	D4	D3	D2	D1	D0	
Prohibition	0	0	0	0	0	0	0	0	
	0	0	0	0	0	0	0	1	
	:	:	:	:	:	:	:	:	
	0	1	1	0	1	0	0	0	
+23dB	0	1	1	0	1	0	0	1	
+22dB	0	1	1	0	1	0	1	0	
+21dB	0	1	1	0	1	0	1	1	
⋮	⋮	⋮	⋮	⋮	⋮	⋮	⋮	⋮	
⋮	⋮	⋮	⋮	⋮	⋮	⋮	⋮	⋮	
⋮	⋮	⋮	⋮	⋮	⋮	⋮	⋮	⋮	
+10dB	0	1	1	1	0	1	1	0	
+9dB	0	1	1	1	0	1	1	1	
+8dB	0	1	1	1	1	0	0	0	
+7dB	0	1	1	1	1	0	0	1	
+6dB	0	1	1	1	1	0	1	0	
+5dB	0	1	1	1	1	0	1	1	
+4dB	0	1	1	1	1	1	0	0	
+3dB	0	1	1	1	1	1	0	1	
+2dB	0	1	1	1	1	1	1	0	
+1dB	0	1	1	1	1	1	1	1	
0dB	1	0	0	0	0	0	0	0	
-1dB	1	0	0	0	0	0	0	1	
-2dB	1	0	0	0	0	0	1	0	
-3dB	1	0	0	0	0	0	1	1	
⋮	⋮	⋮	⋮	⋮	⋮	⋮	⋮	⋮	
⋮	⋮	⋮	⋮	⋮	⋮	⋮	⋮	⋮	
-78dB	1	1	0	0	1	1	1	0	
-79dB	1	1	0	0	1	1	1	1	
Prohibition	1	1	0	1	0	0	0	0	
	:	:	:	:	:	:	:	:	
	1	1	1	1	1	1	1	0	
-∞dB	1	1	1	1	1	1	1	1	

 : Initial condition

Select Address 30(hex)

Mode	Main Gain Adjust							LSB	
	D7	D6	D5	D4	D3	D2	D1	D0	
0dB	Front Mixing	LPF fc	0	0	0	0	Sub Gain Adjust	0	
+6dB								1	

Mode	Sub Gain Adjust							LSB	
	D7	D6	D5	D4	D3	D2	D1	D0	
0dB	Front Mixing	LPF fc	0	0	0	0	0	Main Gain Adjust	
+6dB							1		

Mode	LPF fc							LSB	
	D7	D6	D5	D4	D3	D2	D1	D0	
70kHz	Front Mixing	0	0	0	0	0	Sub Gain Adjust	Main Gain Adjust	
PASS		1							

Mode	Front Mixing ON/OFF							LSB	
	D7	D6	D5	D4	D3	D2	D1	D0	
OFF	0	LPF fc	0	0	0	0	Sub Gain Adjust	Main Gain Adjust	
ON	1								

 : Initial condition

6. About power on reset

It is possible for the reset circuit inside the IC to initialize when supply voltage is turned on. Please send data to all address as initial data when the supply is turned on, and turn on mute until all initial data are sent.

Item	Symbol	Limit			Unit	Condition
		Min	Typ	Max		
Rise time of VCC	t_{RISE}	33	—	—	μsec	VCC rise time from 0V to 5V
VCC voltage of release power on reset	V_{POR}	—	4.1	—	V	

7. About start-up and power off sequence on IC

By setting the terminal voltage of HIVOLB, it is possible to change the output gain. At the same time, output DC voltage will also be changed at each mode.

HIVOLB terminal voltage	High-Voltage
GND to 1.0V	ON
2.3V to VCCL	OFF

Please set HIVOLB terminal voltage between the ranges showed by the above tables. If HIVOLB terminal is open, the terminal voltage will be set to 5V due to the pull-up voltage inside the IC. In this case, the IC will be set to "High-Voltage OFF" mode.

The relationship between DC Bias and Output Gain to the configuration of HIVOLB terminal shows as the following table.

VCCH Supplied Voltage	8.5 V	17 V
HIVOLB Terminal Voltage	Open (5 V) (High-Voltage OFF)	0 V (High-Voltage ON)
Output DC Bias Voltage	4.15 V	8.35 V
Output Gain	0 dB	8.3 dB

If HIVOLB terminal voltage is changed during its operation, Output DC voltage will be also changed shown as above. For reducing these variations, turn the power on after setting the status of the HIVOLB terminal according to the output gain. The start-up and power off sequence is shown next.

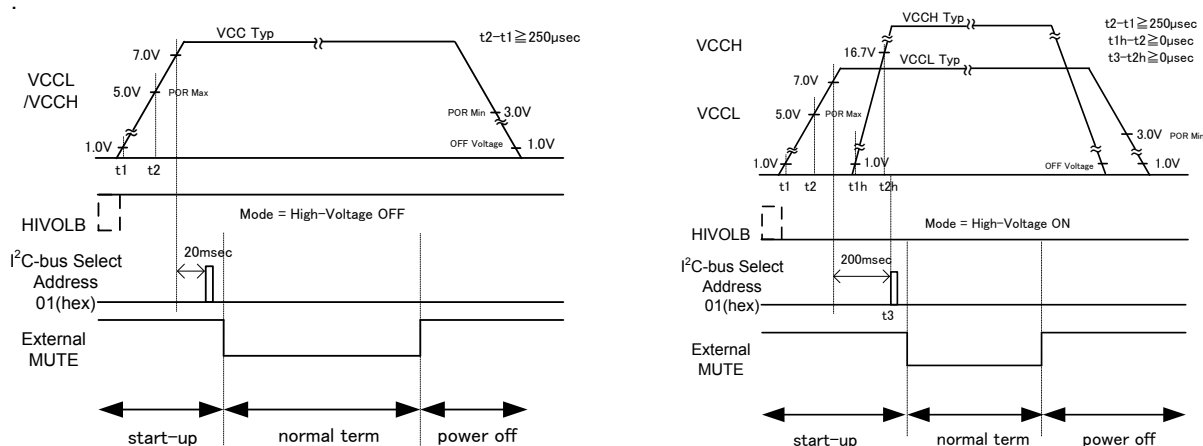

Normal mode operation (HIVOLB terminal = OPEN)

High-Voltage mode operation

Figure 15. Power off and start-up sequence in each mode

This IC will become active-state by sending data of Select Address 01(hex) on I²C-bus. Therefore, this command must always send in start-up sequence. In addition, External MUTE means recommended period that the muting outside IC. In addition, the starting sequence of VCCL and VCCH does not have the limit, but please start VCCL earlier to reduce a pop noise.

About HIVOLB terminal, but measures have been made spike removal, please note that the IC may accept when receiving input more than 50nsec.

Fader Volume Attenuation of the Detail

(dB)	D7	D6	D5	D4	D3	D2	D1	D0	(dB)	D7	D6	D5	D4	D3	D2	D1	D0
+23	0	1	1	0	1	0	0	1	-29	1	0	0	1	1	1	0	1
+22	0	1	1	0	1	0	1	0	-30	1	0	0	1	1	1	1	0
+21	0	1	1	0	1	0	1	1	-31	1	0	0	1	1	1	1	1
+20	0	1	1	0	1	1	0	0	-32	1	0	1	0	0	0	0	0
+19	0	1	1	0	1	1	0	1	-33	1	0	1	0	0	0	0	1
+18	0	1	1	0	1	1	1	0	-34	1	0	1	0	0	0	1	0
+17	0	1	1	0	1	1	1	1	-35	1	0	1	0	0	0	1	1
+16	0	1	1	1	0	0	0	0	-36	1	0	1	0	0	1	0	0
+15	0	1	1	1	0	0	0	1	-37	1	0	1	0	0	1	0	1
+14	0	1	1	1	0	0	1	0	-38	1	0	1	0	0	1	1	0
+13	0	1	1	1	0	0	1	1	-39	1	0	1	0	0	1	1	1
+12	0	1	1	1	0	1	0	0	-40	1	0	1	0	1	0	0	0
+11	0	1	1	1	0	1	0	1	-41	1	0	1	0	1	0	0	1
+10	0	1	1	1	0	1	1	0	-42	1	0	1	0	1	0	1	0
+9	0	1	1	1	0	1	1	1	-43	1	0	1	0	1	0	1	1
+8	0	1	1	1	1	0	0	0	-44	1	0	1	0	1	1	0	0
+7	0	1	1	1	1	0	0	1	-45	1	0	1	0	1	1	0	1
+6	0	1	1	1	1	0	1	0	-46	1	0	1	0	1	1	1	0
+5	0	1	1	1	1	0	1	1	-47	1	0	1	0	1	1	1	1
+4	0	1	1	1	1	1	0	0	-48	1	0	1	1	0	0	0	0
+3	0	1	1	1	1	1	0	1	-49	1	0	1	1	0	0	0	1
+2	0	1	1	1	1	1	1	0	-50	1	0	1	1	0	0	1	0
+1	0	1	1	1	1	1	1	1	-51	1	0	1	1	0	0	1	1
0	1	0	0	0	0	0	0	0	-52	1	0	1	1	0	1	0	0
-1	1	0	0	0	0	0	0	1	-53	1	0	1	1	0	1	0	1
-2	1	0	0	0	0	0	1	0	-54	1	0	1	1	0	1	1	0
-3	1	0	0	0	0	0	1	1	-55	1	0	1	1	0	1	1	1
-4	1	0	0	0	0	1	0	0	-56	1	0	1	1	1	0	0	0
-5	1	0	0	0	0	1	0	1	-57	1	0	1	1	1	0	0	1
-6	1	0	0	0	0	1	1	0	-58	1	0	1	1	1	0	1	0
-7	1	0	0	0	0	1	1	1	-59	1	0	1	1	1	0	1	1
-8	1	0	0	0	1	0	0	0	-60	1	0	1	1	1	1	0	0
-9	1	0	0	0	1	0	0	1	-61	1	0	1	1	1	1	0	1
-10	1	0	0	0	1	0	1	0	-62	1	0	1	1	1	1	1	0
-11	1	0	0	0	1	0	1	1	-63	1	0	1	1	1	1	1	1
-12	1	0	0	0	1	1	0	0	-64	1	1	0	0	0	0	0	0
-13	1	0	0	0	1	1	0	1	-65	1	1	0	0	0	0	0	1
-14	1	0	0	0	1	1	1	0	-66	1	1	0	0	0	0	1	0
-15	1	0	0	0	1	1	1	1	-67	1	1	0	0	0	0	1	1
-16	1	0	0	1	0	0	0	0	-68	1	1	0	0	0	1	0	0
-17	1	0	0	1	0	0	0	1	-69	1	1	0	0	0	1	0	1
-18	1	0	0	1	0	0	1	0	-70	1	1	0	0	0	1	1	0
-19	1	0	0	1	0	0	1	1	-71	1	1	0	0	0	1	1	1
-20	1	0	0	1	0	1	0	0	-72	1	1	0	0	1	0	0	0
-21	1	0	0	1	0	1	0	1	-73	1	1	0	0	1	0	0	1
-22	1	0	0	1	0	1	1	0	-74	1	1	0	0	1	0	1	0
-23	1	0	0	1	0	1	1	1	-75	1	1	0	0	1	0	1	1
-24	1	0	0	1	1	0	0	0	-76	1	1	0	0	1	1	0	0
-25	1	0	0	1	1	0	0	1	-77	1	1	0	0	1	1	0	1
-26	1	0	0	1	1	0	1	0	-78	1	1	0	0	1	1	1	0
-27	1	0	0	1	1	0	1	1	-79	1	1	0	0	1	1	1	1
-28	1	0	0	1	1	1	0	0	-∞	1	1	1	1	1	1	1	1

 : Initial condition

About bias voltage of output terminal(27,28,35 to 40pin) vs. VCC

Bias voltage of output terminal (27,28,35 to 40pin) keep fixed voltage in operational range of VCC.

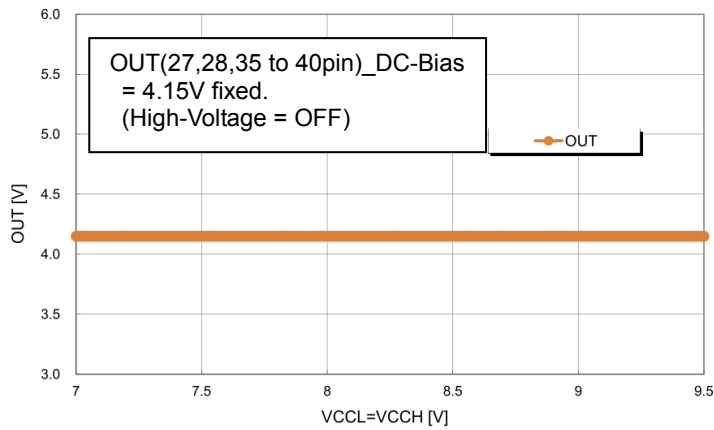

Figure 16. OUT(27,28,35 to 40pin)_DC-Bias = 4.15V fixed. (High-Voltage Mode = OFF)

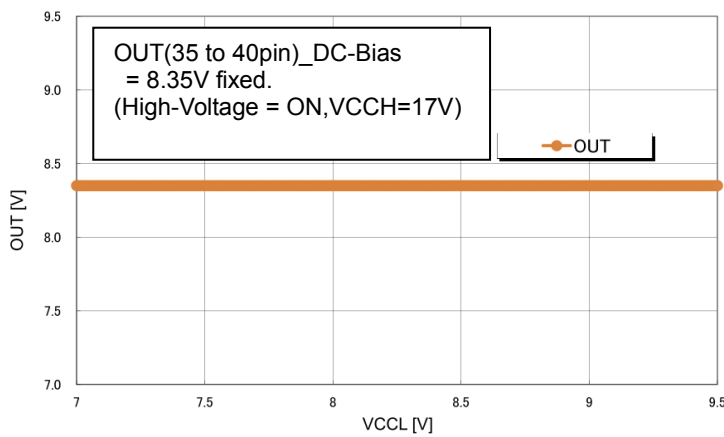

Figure 17. OUT(35 to 40pin)_DC-Bias = 8.35V fixed. (High-Voltage Mode = ON, VCCH=17V)

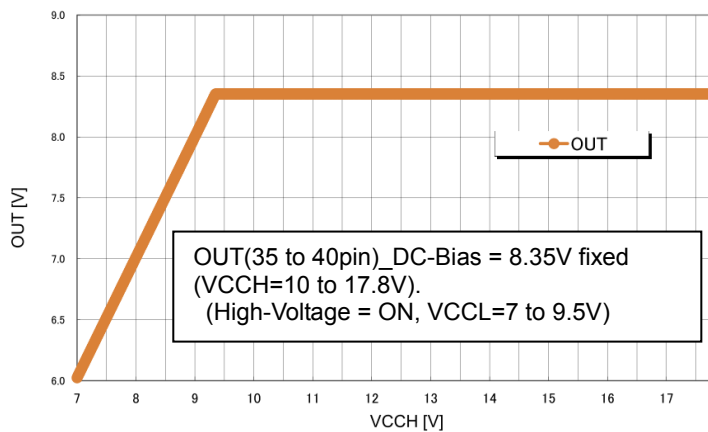

Figure 18. OUT(35 to 40pin)_DC-Bias = 8.35V fixed(VCCH=10 to 17.8V). (High-Voltage Mode = ON, VCCL=7 to 9.5V)

About Advanced Switch Circuit

[1] Advanced switch technology
 1-1. Advanced switch effects

Advanced switch technology is ROHM original technology that can prevent from switching pop noise. If changing the gain setting (for example Fader) immediately, the audible signal will become discontinuously and pop noise will be occurred. This Advanced switch technology will prevent this discontinuous signal by completing the signal waveform and will significantly reduce the noise.

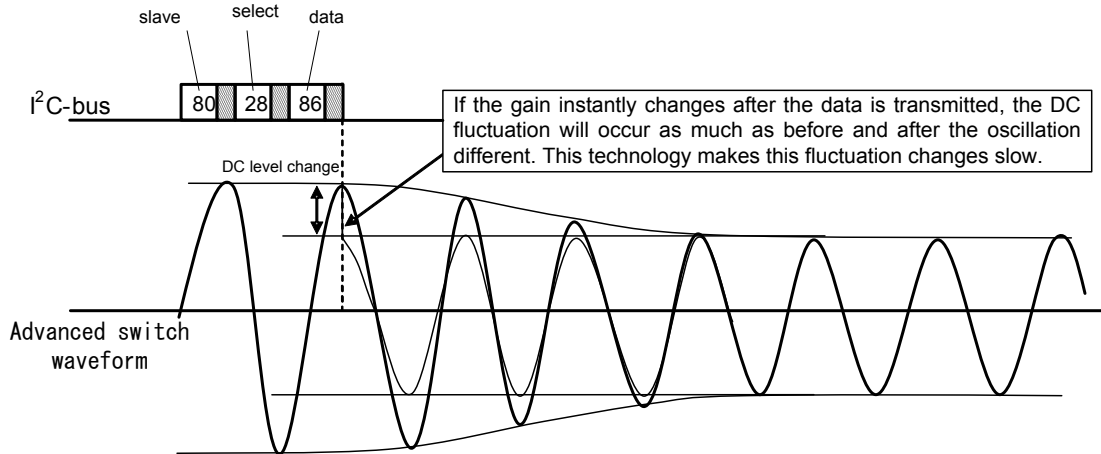

Figure 17. The explanation of advanced switch waveform

This Advanced switch circuit will start operating when the data is transmitted from microcontroller. Advanced switch waveform is shown as the figure above. For preventing switching noise, this IC will operate optimally by internal processing after the data is transmitted from microcontroller.

However, sometimes the switching waveform is not like the intended form depends on the transmission timing. Therefore, below is the example of the relationship between the transmission timing and actual switching time. Please consider this relationship for the setting.

1-2. The kind of the Transferring Data

- Data setting that is not corresponded to Advanced switch
 (Page11 Select Address & Data Data format without hatching)
 There is no particular rule about transferring data.
- Data setting that is corresponded to Advanced switch
 (Page11 Select Address & Data Data format with hatching)
 There is no particular rule about transferring data, but Advanced switch must follow the switching sequence as mentioned in **[2]** as follows.

[2] Data transmission that is corresponded to Advanced switch

2-1. Switching time of Advanced switch

Switching time includes [t_{WAIT}(Wait time)], [t_{SFT}(A→B switching time)] and [t_{SFT}(B→A switching time)].
 25msec is needed per 1 switching. (t_{SOFT} = t_{WAIT} + 2 * t_{SFT}, t_{WAIT} = 2.3msec, t_{SFT} = 11.2msec)

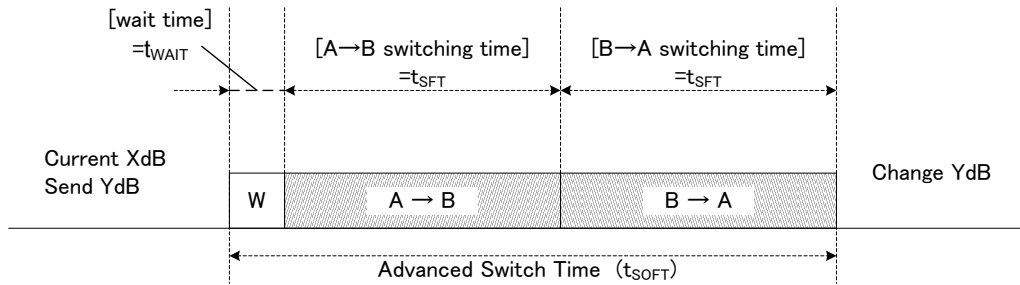

In the figure above, Start/Stop state is expressed as “A” and temporary state is expressed as “B”.
 The switching sequence of Advanced switch consists of the cycle “A(start)→B(temporary)→A(stop)”. Therefore, switching sequence will not stop at B state.

For example, switching is performed from A(Initial gain)→B(set gain)→A(set gain) when switching from initial gain to set gain. And switching time (t_{SFT}) of A→B or B→A are equal.

2-2. About the data transmission's timing in same block state and switching operation

■ Transmitting example 1

This is an example when transmitting data in same block with “enough interval for data transmission”.
 (enough interval for data transmission : 1.4 x t_{SOFT} * ”1.4” includes tolerance margin.)

Definition of example expression :

F1=Fader 1ch Front, F2=Fader 2ch Front, R1=Fader 1ch Rear, R2=Fader 2ch Rear
 C=Fader Center, S=Fader Subwoofer, MIX=Front Mixing

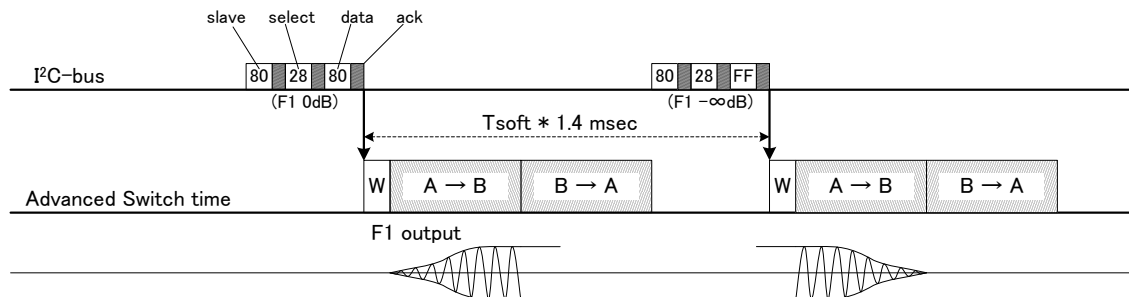

■ Transmitting example 2

This is an example when the transmission interval is not enough (smaller than “Transmission example 1”). When the data is transmitted during first switching operation, the second data will be reflected after the first switching operation. In this case, there is no wait time (t_{WAIT}) before the second switching operation.

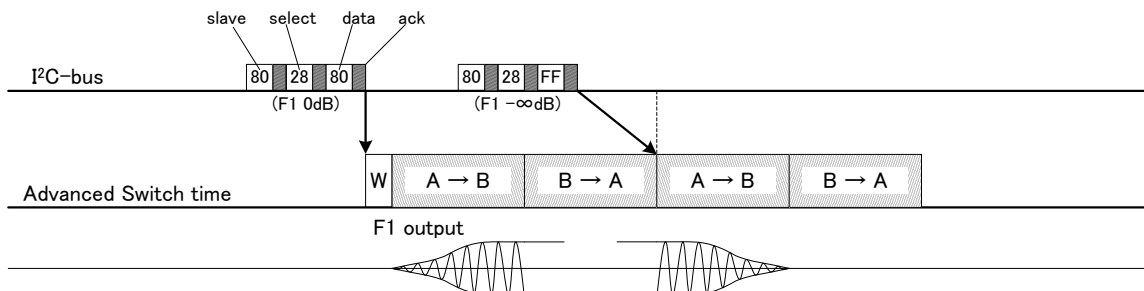

■ Transmitting example 3

This is an example of switching operation when transmission interval is smaller than “Transmission example 2”). When the data is transmitted during the first switching operation, and transmission timing is just during A→B switching operation, the second data will be reflected at B→A switching term.

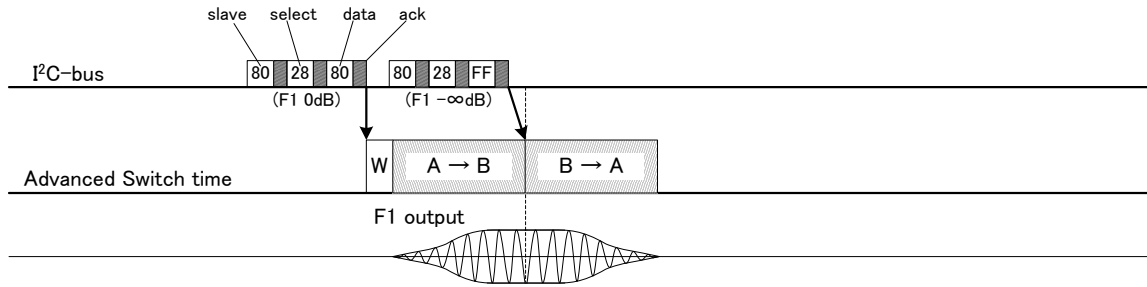

■ Transmitting example 4

The below figure shows an example of switching operation that the data are transmitted serially with smaller transmission interval than “Transmission example 3”. IC has internal data-storage buffer and buffer transmitted data as storage data constantly. However, only the latest data is kept so, in this example, +4dB data transmitted secondly is ignored.

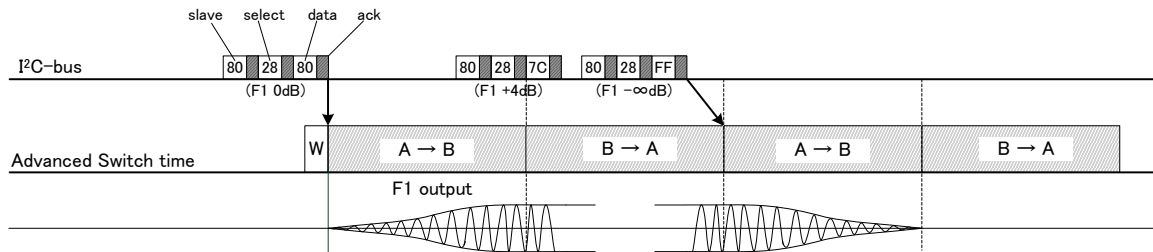

■ Transmitting example 5

Transmitted data is firstly buffered and written to setting data which set gain. However, when there is no difference between transmitted data and setting data such as refresh data, advanced switch operation doesn't start.

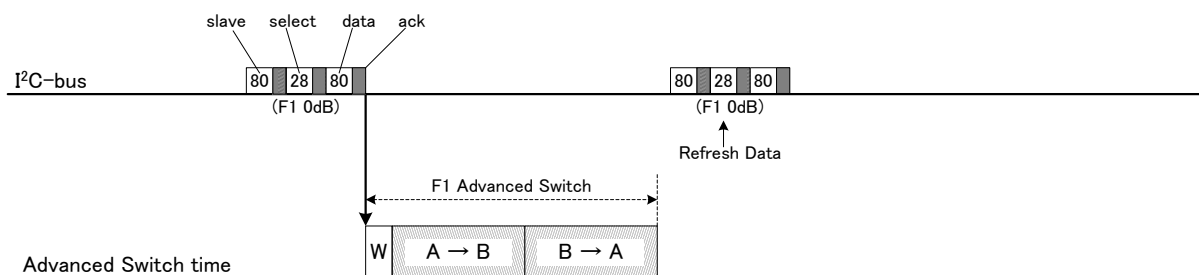

2-3. Mixing ON/OFF switching operation of Front mixing

The action of the Mixing switching waveform is different in OFF to ON or ON to OFF.

■ Transmission example 1

This is an example of Mixing OFF to ON state.

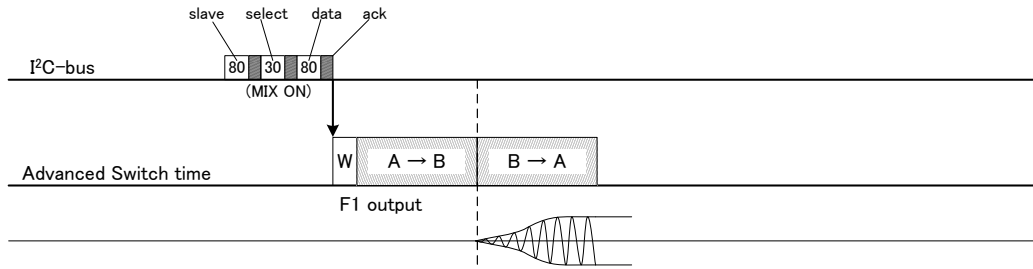

This is an example of Mixing ON to OFF state

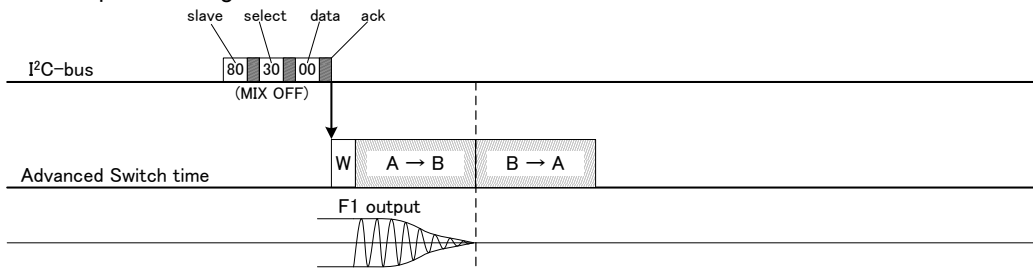

■ Transmission example 2

This is an example when transmission ON to OFF in short interval during to Mixing switching operation.

This is an example of in case of transmitted data of another status(MIX OFF) in during A→B transmission timing.

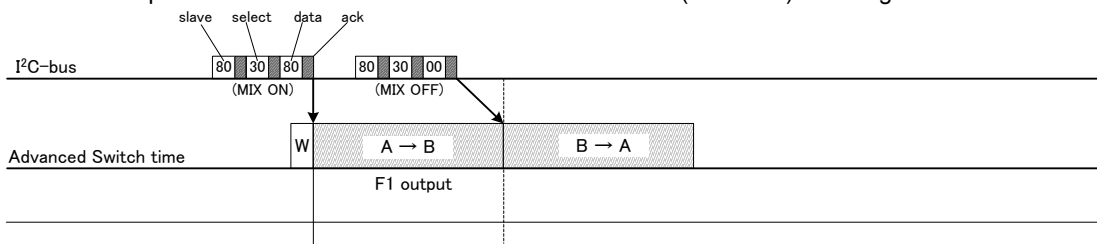

This is an example of in case of transmitted data of another status(MIX OFF) in during B→A transmission timing.

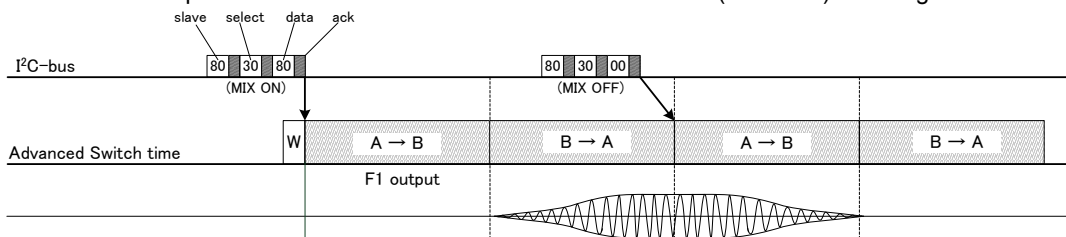

■ Transmission example 3

This is an example when transmission OFF to ON in short interval during to Mixing switching operation.

This is an example of in case of transmitted data of another status(MIX ON) in during A→B transmission timing.

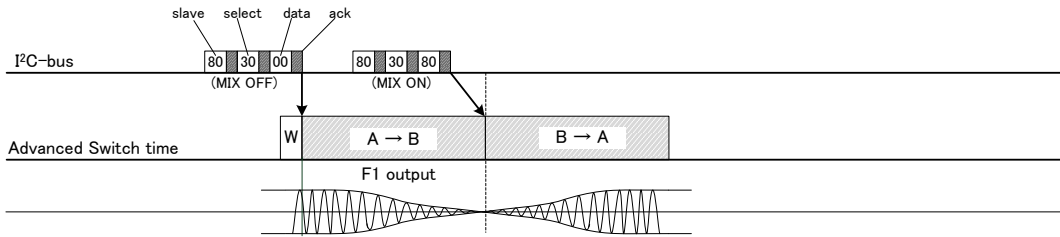

This is an example of in case of transmitted data of another status(MIX ON) in during B→A transmission timing.

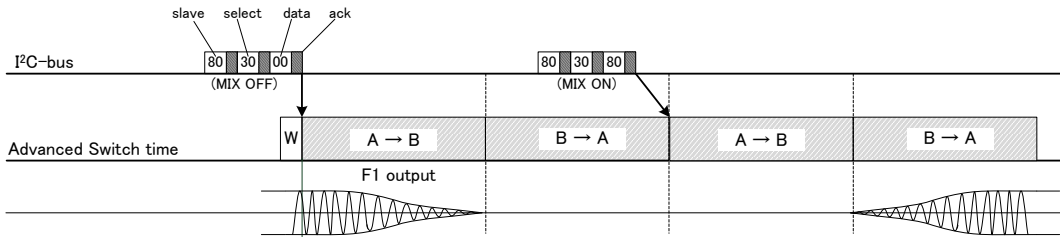

2-3. About the data transmitting timing and the switching movement in several block state

When data are transmitted to several blocks, treatment in the BS (block state) unit is carried out inside the IC. The order of advanced switch movement start is decided in advance dependent on BS.

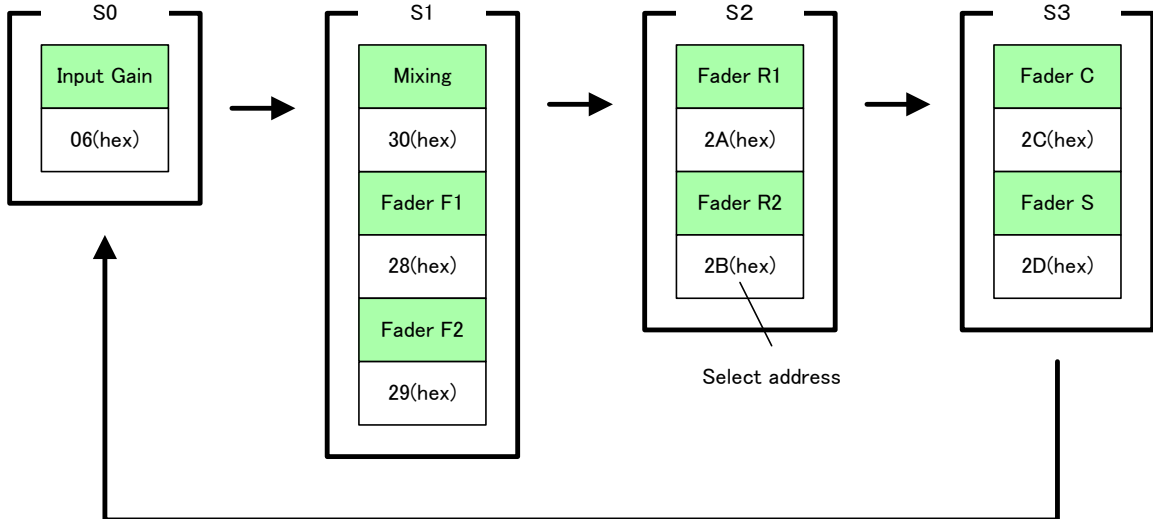

The order of advanced switch start

Note) It is possible that blocks in the same BS start switching at the same timing.

■ Transmitting example 1

About the transmission to several blocks also, as explained in the previous section, though there is no restriction of the I²C-bus data transmitting timing, the start timing of switching follows the figure of previous page, The order of advanced switch start.

Therefore, it isn't based on the data transmitting order, and an actual switching order becomes as the figure of previous page, "The order of advanced switch start".

Each block data is being transmitted separately in the transmitting example 5, but it becomes the same result even if data are transmitted by automatic increment.

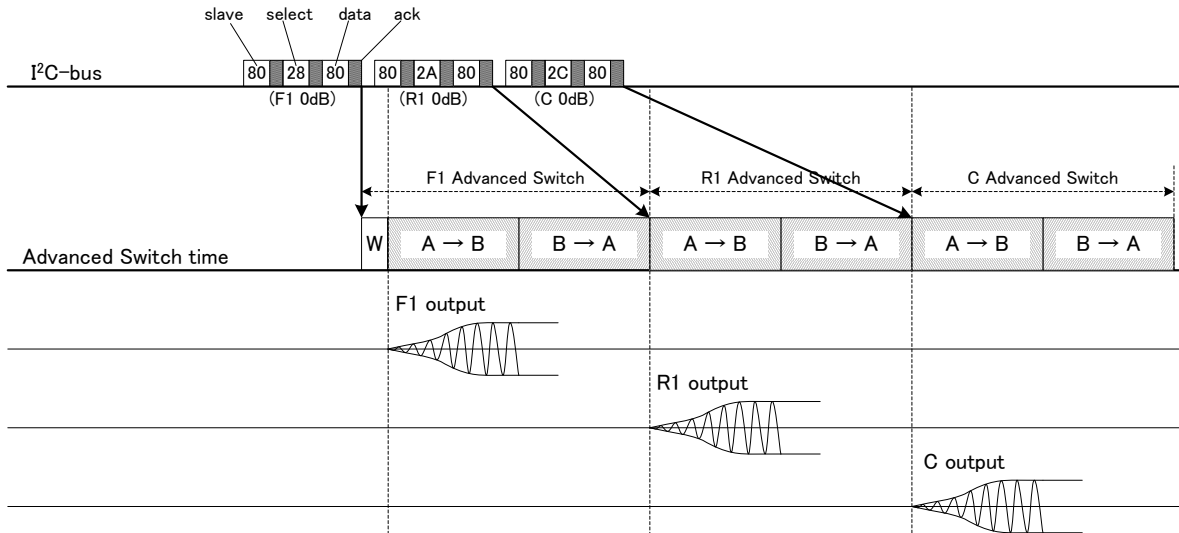

■ Transmitting example 2

In the case that data transmission order and actual switching order is different, or data is transmitted to the block in other BS before the advanced switch operation finished, switching of next BS starts after current switching.

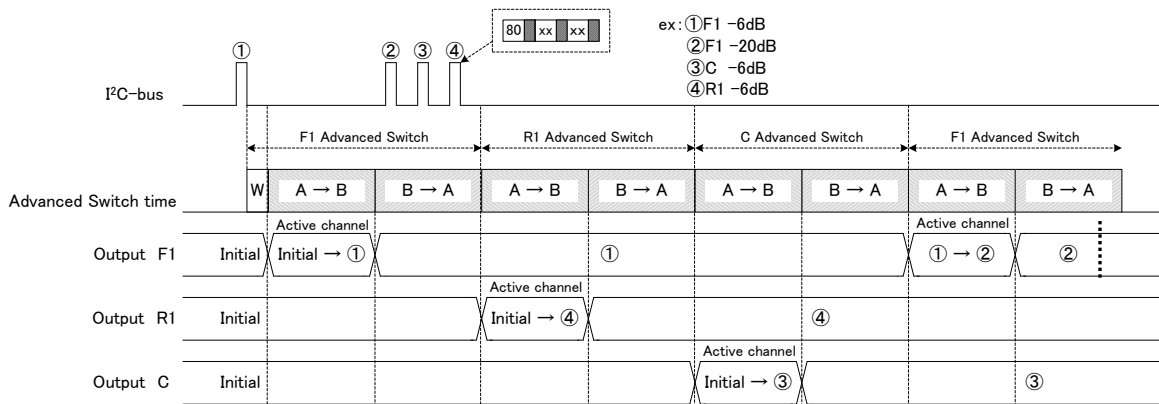

Application Circuit Diagram

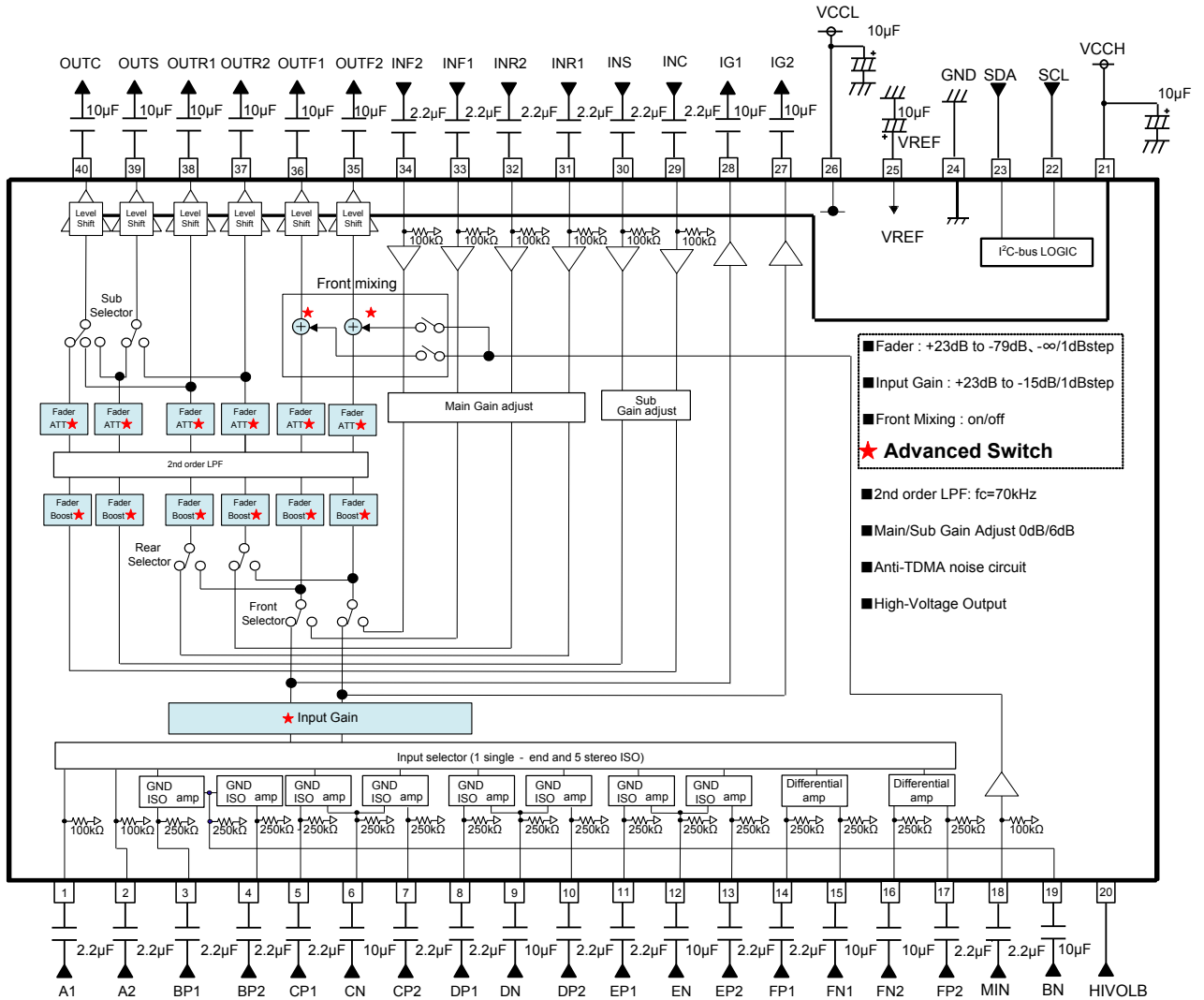

Figure 20. Application Circuit Diagram

Notes on wiring

- ① Please connect the decoupling capacitor of a power supply as close as possible to GND.
- ② Lines of GND shall be one-point connected.
- ③ Wiring pattern of Digital shall be away from that of analog unit and cross-talk shall not be acceptable.
- ④ Lines of SCL and SDA of I²C-bus shall not be parallel if possible. The lines shall be shielded, if they are adjacent to each other.
- ⑤ Lines of analog input shall not be parallel if possible. The lines shall be shielded, if they are adjacent to each other.

Thermal Derating Curve

About the thermal design by the IC

Characteristics of an IC have a great deal to do with the temperature at which it is used, and exceeding absolute maximum ratings may degrade and destroy elements. Careful consideration must be given to the heat of the IC from the two standpoints of immediate damage and long-term reliability of operation.

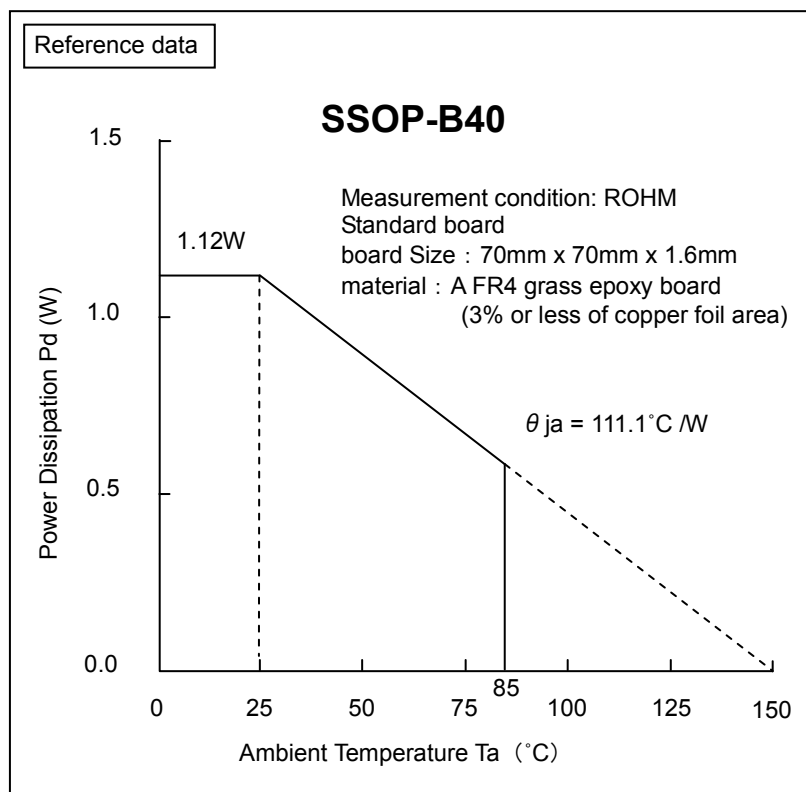

Figure 21. Temperature Derating Curve

Note) Values are actual measurements and are not guaranteed.

Note) Power dissipation values vary according to the board on which the IC is mounted.

I/O Equivalence Circuit

Terminal No	Terminal Name	Terminal Voltage	Equivalent Circuit	Terminal Description
1 2 29 30 31 32 33 34 18	A1 A2 INC INS INR1 INR2 INF1 INF2 MIN	4.15V		Terminal for signal input The input impedance is 100kΩ(Typ).
3 4 5 6 7 8 9 10 11 12 13 14 15 16 17 19	BP1 BP2 CP1 CN CP2 DP1 DN DP2 EP1 EN EP2 FP1 FN1 FN2 FP2 BN	4.15V		Input terminal Single/Differential mode is selectable. The input impedance is 250kΩ(Typ).
27 28	IG2 IG1	4.15V		Input Gain output terminal
35 36 37 38 39 40	OUTF2 OUTF1 OUTR2 OUTR1 OUTS OUTC	8.35/4.15V		Fader output terminal High-Voltage OFF : 4.15V High-Voltage ON : 8.35V

The figures in the pin explanation and input/output equivalent circuit is designed value, it doesn't guarantee the value.

Terminal No	Terminal Name	Terminal Voltage	Equivalent Circuit	Terminal Description
20	HIVOLB	5V		<p>Output gain control terminal</p> <p>Low(0V supply) : High-Voltage ON High(terminal open) : High-Voltage OFF</p>
21 26	VCCH VCCL	17/8.5V 8.5V		Power supply terminal
22	SCL	—		<p>Terminal for clock input of I²C-bus communication</p> <p>Note: When this pin is shorted to next pin(VCCH), it may result in property degradation and destruction of the device.</p>
23	SDA	—		Terminal for data input of I ² C- bus communication
24	GND	0V		Ground terminal
25	VREF	4.15V		<p>BIAS terminal</p> <p>Voltage for reference bias of analog signal system. The simple precharge circuit and simple discharge circuit for an external capacitor are built in.</p>

The figures in the pin explanation and input/output equivalent circuit is designed value, it doesn't guarantee the value.

Application Information

1. Absolute maximum rating voltage

When voltage is impressed to VCCL/VCCH exceeding absolute-maximum-rating voltage, circuit current increase rapidly, and it may result in property degradation and destruction of a device.

When impressed by a VCCL terminal (26pin) especially by surge examination etc., even if it includes an of operation voltage +surge pulse component, be careful not to impress voltage (about 14V VCCL terminal) greatly more than absolute-maximum-rating voltage. And, be careful that there is no more than 18V VCCH terminal (21pin) also one.

2. About a signal input part

In the signal input terminal, the value of the input coupling capacitor C(F) should be sufficient to match the value of input impedance $R_{IN}(\Omega)$ inside the IC. The first HPF characteristic of CR is as shown below.

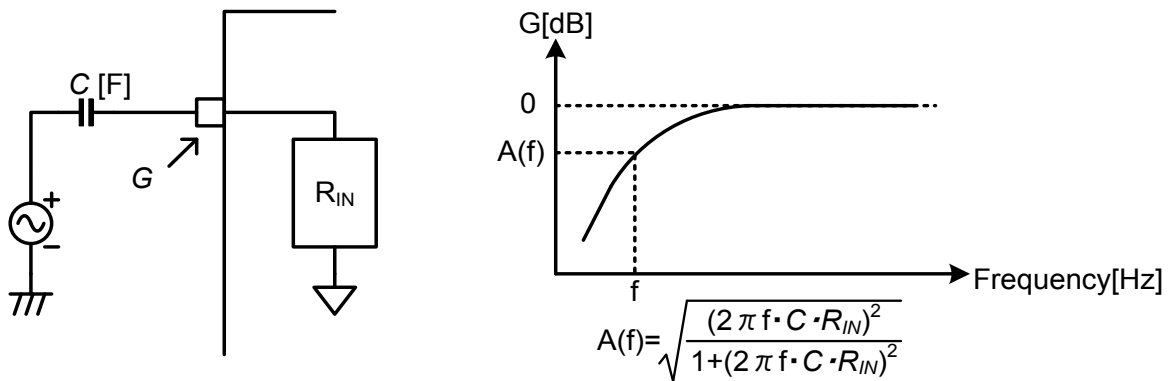

Figure 22. Input Equivalent Circuit

3. About output load characteristics

The usages of load for output are below (reference). Please use the load more than 10 k Ω (Typ).

Output terminal

Terminal No.	Terminal Name	Terminal No.	Terminal Name	Terminal No.	Terminal Name	Terminal No.	Terminal Name
28	IG1	36	OUTF1	38	OUTR1	40	OUTC
27	IG2	35	OUTF2	37	OUTR2	39	OUTS

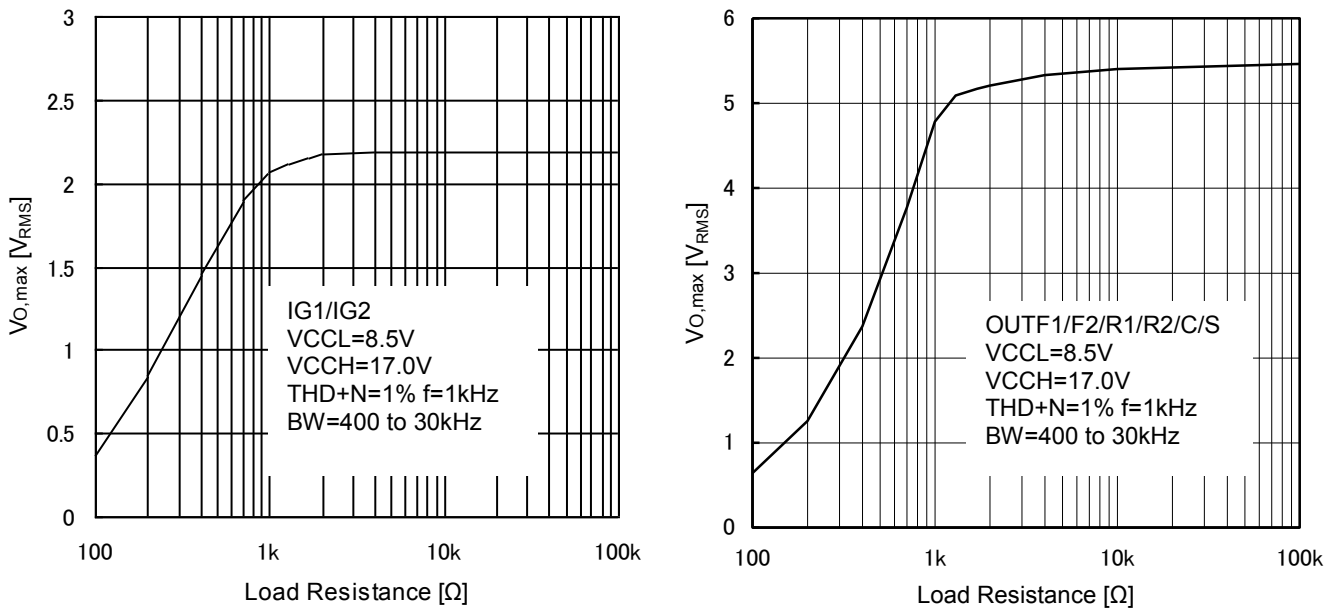

Figure 23. Output load characteristic at VCCL=8.5V, VCCH=17.0V(Reference)

Application Information - continued

4. About HIVOLB terminal(20pin) when power supply is off
Any voltage shall not be supplied to HIVOLB terminal (20pin) when power-supply is off.
Please insert a resistor (about 2.2k Ω) to HIVOLB terminal in series, if voltage is supplied to HIVOLB terminal in case.
5. About signal input terminals
Because the inner impedance of the terminal becomes 100 k Ω or 250 k Ω when the signal input terminal makes a terminal open, the plunge noise from outside sometimes becomes a problem. When there is an unused signal input terminal, design so it is shorted to ground.
6. About changing gain of Input Gain and Fader Volume
In case of the boost of the input gain and fader volume when changing to the high gain which exceeds 20 dB especially, the switching pop noise sometimes becomes big.
In this case, we recommend changing every 1 dB step without changing a gain at once.
Also, the pop noise sometimes can reduce by making advanced switch time long, too.
7. About inter-pin short to VCCH
VCCH terminal(21pin) is assumed that applied high voltage(17.8V_{MAX}) for realization of 5.2V_{RMS} (MAX) output.
And so, avoid short between VCCH and SCL, other. When Inter-pin shorts, circuit current increase rapidly, and it may result in property degradation and destruction of a device.

Operational Notes

- 1. Reverse Connection of Power Supply**
Connecting the power supply in reverse polarity can damage the IC. Take precautions against reverse polarity when connecting the power supply, such as mounting an external diode between the power supply and the IC's power supply pins.
- 2. Power Supply Lines**
Design the PCB layout pattern to provide low impedance supply lines. Separate the ground and supply lines of the digital and analog blocks to prevent noise in the ground and supply lines of the digital block from affecting the analog block. Furthermore, connect a capacitor to ground at all power supply pins. Consider the effect of temperature and aging on the capacitance value when using electrolytic capacitors.
- 3. Ground Voltage**
Ensure that no pins are at a voltage below that of the ground pin at any time, even during transient condition.
- 4. Ground Wiring Pattern**
When using both small-signal and large-current ground traces, the two ground traces should be routed separately but connected to a single ground at the reference point of the application board to avoid fluctuations in the small-signal ground caused by large currents. Also ensure that the ground traces of external components do not cause variations on the ground voltage. The ground lines must be as short and thick as possible to reduce line impedance.
- 5. Thermal Consideration**
Should by any chance the maximum junction temperature rating be exceeded the rise in temperature of the chip may result in deterioration of the properties of the chip. In case of exceeding this absolute maximum rating, increase the board size and copper area to prevent exceeding the maximum junction temperature rating.
- 6. Recommended Operating Conditions**
These conditions represent a range within which the expected characteristics of the IC can be approximately obtained. The electrical characteristics are guaranteed under the conditions of each parameter.
- 7. Inrush Current**
When power is first supplied to the IC, it is possible that the internal logic may be unstable and inrush current may flow instantaneously due to the internal powering sequence and delays, especially if the IC has more than one power supply. Therefore, give special consideration to power coupling capacitance, power wiring, width of ground wiring, and routing of connections.
- 8. Operation Under Strong Electromagnetic Field**
Operating the IC in the presence of a strong electromagnetic field may cause the IC to malfunction.
- 9. Testing on Application Boards**
When testing the IC on an application board, connecting a capacitor directly to a low-impedance output pin may subject the IC to stress. Always discharge capacitors completely after each process or step. The IC's power supply should always be turned off completely before connecting or removing it from the test setup during the inspection process. To prevent damage from static discharge, ground the IC during assembly and use similar precautions during transport and storage.

Operational Notes – continued

10. Inter-pin Short and Mounting Errors

Ensure that the direction and position are correct when mounting the IC on the PCB. Incorrect mounting may result in damaging the IC. Avoid nearby pins being shorted to each other especially to ground, power supply and output pin. Inter-pin shorts could be due to many reasons such as metal particles, water droplets (in very humid environment) and unintentional solder bridge deposited in between pins during assembly to name a few.

11. Regarding the Input Pin of the IC

This monolithic IC contains P+ isolation and P substrate layers between adjacent elements in order to keep them isolated. P-N junctions are formed at the intersection of the P layers with the N layers of other elements, creating a parasitic diode or transistor. For example (refer to figure below):

When $GND > Pin A$ and $GND > Pin B$, the P-N junction operates as a parasitic diode.
 When $GND > Pin B$, the P-N junction operates as a parasitic transistor.

Parasitic diodes inevitably occur in the structure of the IC. The operation of parasitic diodes can result in mutual interference among circuits, operational faults, or physical damage. Therefore, conditions that cause these diodes to operate, such as applying a voltage lower than the GND voltage to an input pin (and thus to the P substrate) should be avoided.

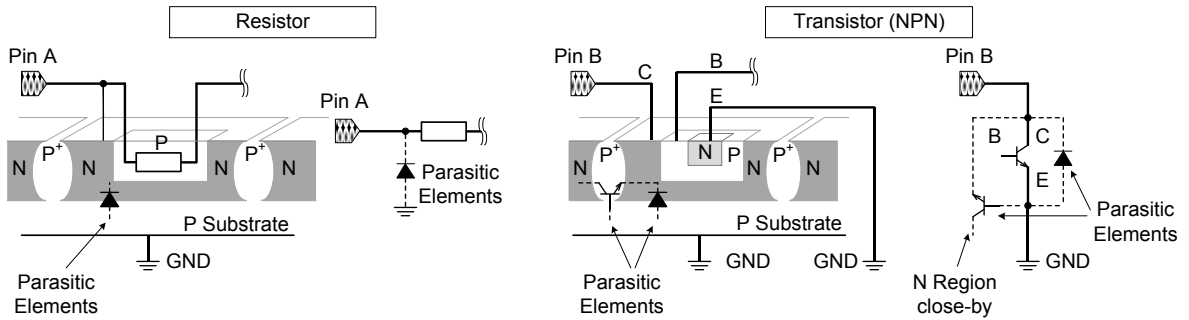
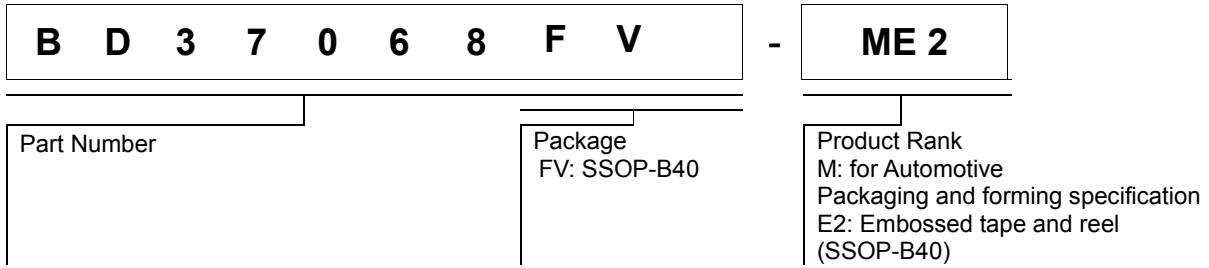

Figure 24. Example of monolithic IC structure

Ordering Name Selection



Physical Dimension Tape and Reel Information

SSOP-B40

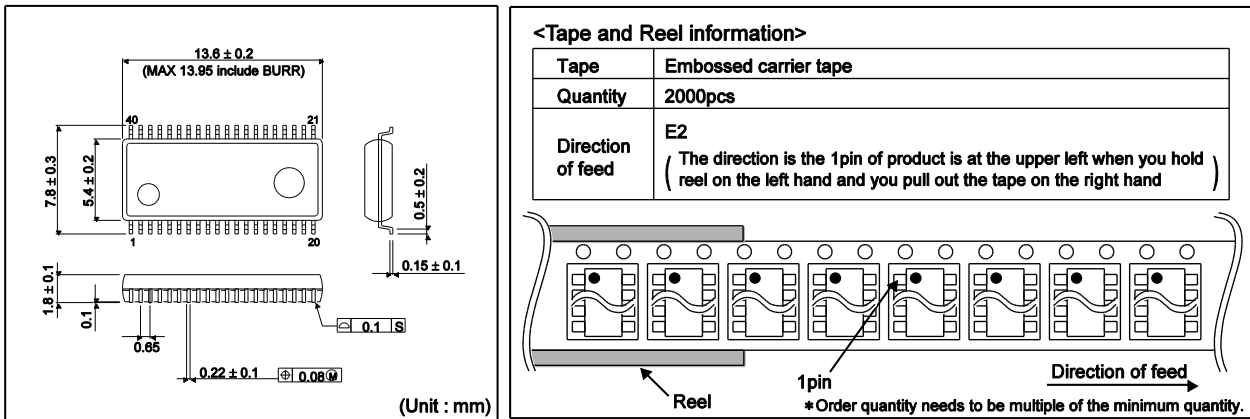

Marking Diagram

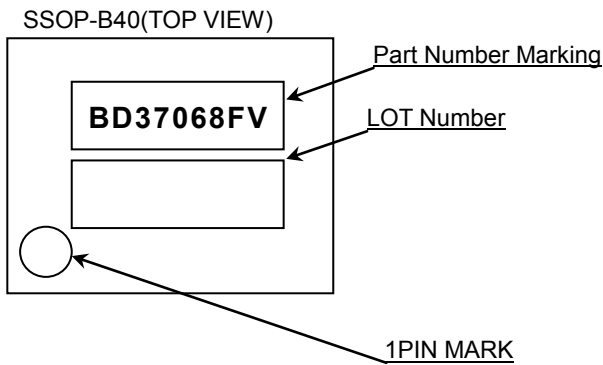

Revision History

Date	Revision	Changes
13.MAR.2014	001	New Release
14.NOV.2016	002	<ul style="list-style-type: none">• Additional specification about advanced switch operation• Additional specification of power supply sequence• Change document style of specification

Notice

Precaution on using ROHM Products

1. If you intend to use our Products in devices requiring extremely high reliability (such as medical equipment ^(Note 1), aircraft/spacecraft, nuclear power controllers, etc.) and whose malfunction or failure may cause loss of human life, bodily injury or serious damage to property ("Specific Applications"), please consult with the ROHM sales representative in advance. Unless otherwise agreed in writing by ROHM in advance, ROHM shall not be in any way responsible or liable for any damages, expenses or losses incurred by you or third parties arising from the use of any ROHM's Products for Specific Applications.

(Note1) Medical Equipment Classification of the Specific Applications

JAPAN	USA	EU	CHINA
CLASS III	CLASS III	CLASS II b	CLASS III
CLASS IV		CLASS III	

2. ROHM designs and manufactures its Products subject to strict quality control system. However, semiconductor products can fail or malfunction at a certain rate. Please be sure to implement, at your own responsibilities, adequate safety measures including but not limited to fail-safe design against the physical injury, damage to any property, which a failure or malfunction of our Products may cause. The following are examples of safety measures:
 - [a] Installation of protection circuits or other protective devices to improve system safety
 - [b] Installation of redundant circuits to reduce the impact of single or multiple circuit failure
3. Our Products are not designed under any special or extraordinary environments or conditions, as exemplified below. Accordingly, ROHM shall not be in any way responsible or liable for any damages, expenses or losses arising from the use of any ROHM's Products under any special or extraordinary environments or conditions. If you intend to use our Products under any special or extraordinary environments or conditions (as exemplified below), your independent verification and confirmation of product performance, reliability, etc. prior to use, must be necessary:
 - [a] Use of our Products in any types of liquid, including water, oils, chemicals, and organic solvents
 - [b] Use of our Products outdoors or in places where the Products are exposed to direct sunlight or dust
 - [c] Use of our Products in places where the Products are exposed to sea wind or corrosive gases, including Cl₂, H₂S, NH₃, SO₂, and NO₂
 - [d] Use of our Products in places where the Products are exposed to static electricity or electromagnetic waves
 - [e] Use of our Products in proximity to heat-producing components, plastic cords, or other flammable items
 - [f] Sealing or coating our Products with resin or other coating materials
 - [g] Use of our Products without cleaning residue of flux (even if you use no-clean type fluxes, cleaning residue of flux is recommended); or Washing our Products by using water or water-soluble cleaning agents for cleaning residue after soldering
 - [h] Use of the Products in places subject to dew condensation
4. The Products are not subject to radiation-proof design.
5. Please verify and confirm characteristics of the final or mounted products in using the Products.
6. In particular, if a transient load (a large amount of load applied in a short period of time, such as pulse. is applied, confirmation of performance characteristics after on-board mounting is strongly recommended. Avoid applying power exceeding normal rated power; exceeding the power rating under steady-state loading condition may negatively affect product performance and reliability.
7. De-rate Power Dissipation depending on ambient temperature. When used in sealed area, confirm that it is the use in the range that does not exceed the maximum junction temperature.
8. Confirm that operation temperature is within the specified range described in the product specification.
9. ROHM shall not be in any way responsible or liable for failure induced under deviant condition from what is defined in this document.

Precaution for Mounting / Circuit board design

1. When a highly active halogenous (chlorine, bromine, etc.) flux is used, the residue of flux may negatively affect product performance and reliability.
2. In principle, the reflow soldering method must be used on a surface-mount products, the flow soldering method must be used on a through hole mount products. If the flow soldering method is preferred on a surface-mount products, please consult with the ROHM representative in advance.

For details, please refer to ROHM Mounting specification

Precautions Regarding Application Examples and External Circuits

1. If change is made to the constant of an external circuit, please allow a sufficient margin considering variations of the characteristics of the Products and external components, including transient characteristics, as well as static characteristics.
2. You agree that application notes, reference designs, and associated data and information contained in this document are presented only as guidance for Products use. Therefore, in case you use such information, you are solely responsible for it and you must exercise your own independent verification and judgment in the use of such information contained in this document. ROHM shall not be in any way responsible or liable for any damages, expenses or losses incurred by you or third parties arising from the use of such information.

Precaution for Electrostatic

This Product is electrostatic sensitive product, which may be damaged due to electrostatic discharge. Please take proper caution in your manufacturing process and storage so that voltage exceeding the Products maximum rating will not be applied to Products. Please take special care under dry condition (e.g. Grounding of human body / equipment / solder iron, isolation from charged objects, setting of Ionizer, friction prevention and temperature / humidity control).

Precaution for Storage / Transportation

1. Product performance and soldered connections may deteriorate if the Products are stored in the places where:
 - [a] the Products are exposed to sea winds or corrosive gases, including Cl₂, H₂S, NH₃, SO₂, and NO₂
 - [b] the temperature or humidity exceeds those recommended by ROHM
 - [c] the Products are exposed to direct sunshine or condensation
 - [d] the Products are exposed to high Electrostatic
2. Even under ROHM recommended storage condition, solderability of products out of recommended storage time period may be degraded. It is strongly recommended to confirm solderability before using Products of which storage time is exceeding the recommended storage time period.
3. Store / transport cartons in the correct direction, which is indicated on a carton with a symbol. Otherwise bent leads may occur due to excessive stress applied when dropping of a carton.
4. Use Products within the specified time after opening a humidity barrier bag. Baking is required before using Products of which storage time is exceeding the recommended storage time period.

Precaution for Product Label

A two-dimensional barcode printed on ROHM Products label is for ROHM's internal use only.

Precaution for Disposition

When disposing Products please dispose them properly using an authorized industry waste company.

Precaution for Foreign Exchange and Foreign Trade act

Since concerned goods might be fallen under listed items of export control prescribed by Foreign exchange and Foreign trade act, please consult with ROHM in case of export.

Precaution Regarding Intellectual Property Rights

1. All information and data including but not limited to application example contained in this document is for reference only. ROHM does not warrant that foregoing information or data will not infringe any intellectual property rights or any other rights of any third party regarding such information or data.
2. ROHM shall not have any obligations where the claims, actions or demands arising from the combination of the Products with other articles such as components, circuits, systems or external equipment (including software).
3. No license, expressly or implied, is granted hereby under any intellectual property rights or other rights of ROHM or any third parties with respect to the Products or the information contained in this document. Provided, however, that ROHM will not assert its intellectual property rights or other rights against you or your customers to the extent necessary to manufacture or sell products containing the Products, subject to the terms and conditions herein.

Other Precaution

1. This document may not be reprinted or reproduced, in whole or in part, without prior written consent of ROHM.
2. The Products may not be disassembled, converted, modified, reproduced or otherwise changed without prior written consent of ROHM.
3. In no event shall you use in any way whatsoever the Products and the related technical information contained in the Products or this document for any military purposes, including but not limited to, the development of mass-destruction weapons.
4. The proper names of companies or products described in this document are trademarks or registered trademarks of ROHM, its affiliated companies or third parties.

General Precaution

1. Before you use our Products, you are requested to carefully read this document and fully understand its contents. ROHM shall not be in any way responsible or liable for failure, malfunction or accident arising from the use of any ROHM's Products against warning, caution or note contained in this document.
2. All information contained in this document is current as of the issuing date and subject to change without any prior notice. Before purchasing or using ROHM's Products, please confirm the latest information with a ROHM sales representative.
3. The information contained in this document is provided on an "as is" basis and ROHM does not warrant that all information contained in this document is accurate and/or error-free. ROHM shall not be in any way responsible or liable for any damages, expenses or losses incurred by you or third parties resulting from inaccuracy or errors of or concerning such information.

Mouser Electronics

Authorized Distributor

Click to View Pricing, Inventory, Delivery & Lifecycle Information:

[ROHM Semiconductor:](#)

[BD37068FV-ME2](#)



Стандарт Электрон Связь

Мы молодая и активно развивающаяся компания в области поставок электронных компонентов. Мы поставляем электронные компоненты отечественного и импортного производства напрямую от производителей и с крупнейших складов мира.

Благодаря сотрудничеству с мировыми поставщиками мы осуществляем комплексные и плановые поставки широчайшего спектра электронных компонентов.

Собственная эффективная логистика и склад в обеспечивает надежную поставку продукции в точно указанные сроки по всей России.

Мы осуществляем техническую поддержку нашим клиентам и предпродажную проверку качества продукции. На все поставляемые продукты мы предоставляем гарантию .

Осуществляем поставки продукции под контролем ВП МО РФ на предприятия военно-промышленного комплекса России , а также работаем в рамках 275 ФЗ с открытием отдельных счетов в уполномоченном банке. Система менеджмента качества компании соответствует требованиям ГОСТ ISO 9001.

Минимальные сроки поставки, гибкие цены, неограниченный ассортимент и индивидуальный подход к клиентам являются основой для выстраивания долгосрочного и эффективного сотрудничества с предприятиями радиоэлектронной промышленности, предприятиями ВПК и научно-исследовательскими институтами России.

С нами вы становитесь еще успешнее!

Наши контакты:

Телефон: +7 812 627 14 35

Электронная почта: sales@st-electron.ru

Адрес: 198099, Санкт-Петербург,
Промышленная ул, дом № 19, литера Н,
помещение 100-Н Офис 331