

### Typical Applications

The HMC611LP4(E) is ideal for IF and RF applications in:

- Cellular/PCS/3G
- WiMAX, WiBro, WLAN, Fixed Wireless & Radar
- Power Monitoring & Control Circuitry
- Receiver Signal Strength Indication (RSSI)
- Automatic Gain & Power Control

### Features

- Wide Dynamic Range: Up to 63 dB
- High Accuracy:  $\pm 1$  dB with 54 dB Range Up to 8 GHz
- Supply Voltage: +5V
- Excellent Stability over Temperature
- Buffered Temperature Sensor Output
- Compact 4x4mm Leadless SMT Package

### Functional Diagram

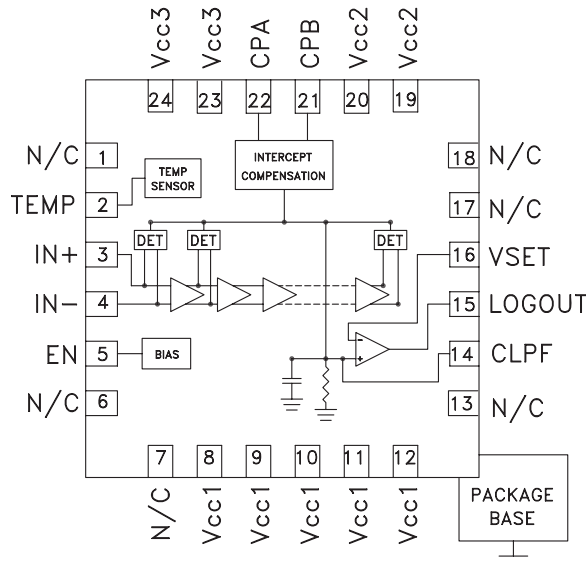

### General Description

The HMC611LP4(E) Logarithmic Detector/Controller converts RF signals at its input, to a proportional DC voltage at its output. The HMC611LP4(E) employs a successive compression topology which delivers extremely high dynamic range and conversion accuracy over a wide input frequency range. As the input power is increased, successive amplifiers move into saturation one by one creating an accurate approximation of the logarithm function. The output of a series of square law detectors is summed, converted into voltage domain and buffered to drive the LOGOUT output. For detection mode, the LOGOUT pin is shorted to the VSET input, and will provide a nominal logarithmic slope of -25mV/dB and an intercept of 12 dBm (20 dBm for  $f \geq 5.8$  GHz). The HMC611LP4(E) can also be used in the controller mode where an external voltage is applied to the VSET pin, to create an AGC or APC feedback loop.

### Electrical Specifications, $T_A = +25C^{[1]}$

Parameter	Typ.	Typ.	Typ.	Typ.	Typ.	Typ.	Typ.	Typ.	Typ.	Typ.	Typ.	Units
Input Frequency	50	100	900	1900	2200	3600	5800	7000	7500	8000	10000	MHz
$\pm 3$ dB Dynamic Range	70	70	71	72	72	66	69	65	63	62	47	dB
$\pm 3$ dB Dynamic Range Center	-30	-30	-35.5	-37	-36	-36	-24.5	-22.5	-22.5	-22	-19.5	dBm
$\pm 1$ dB Dynamic Range	61	61	63	63	62	60	61	59	56	54	39	dB
Output Slope	-25.8	-25.8	-25.5	-25.0	-24.9	-24.4	-24.9	-26.5	-27.1	-27.8	-28.5	mV/dB
Output Intercept	12.5	12.6	12.7	12.2	11.9	12.9	20.1	20.5	19.9	17.2	15.8	dBm
Temperature Sensitivity @ -10 dBm Input <sup>[2]</sup>	2	2	1.1	-0.8	-0.8	7	-3	-3	-3	0	-1	mdB/ $^{\circ}C$

[1] Detector mode measurements; LOGOUT (Pin 15) is shorted to VSET (Pin 16).

[2] Measured from  $T_A = -45C$  to  $T_A = +85C$

### Electrical Specifications, (continued)

Parameter	Conditions	Min.	Typ.	Max.	Units
<b>LOGOUT Interface</b>					
Output Voltage Range		0		Vcc -1.0	V
Output Rise Time/Fall Time	From 0% to 90%		21/9		ns
<b>VSET Interface</b>					
Input Impedance			30		kΩ
Input Voltage Range			0.25 to 1.35		V
Low Frequency Gain	VSET to LOGOUT		56		dB
Open Loop Corner Frequency			700		kHz
<b>Power Down (EN) Interface</b>					
Voltage Range for Normal Mode		0.8 x Vcc [1]		Vcc [1]	V
Voltage Range for Powerdown Mode		0		0.2 x Vcc [1]	V
Threshold Voltage			Vcc [1]/2		V
<b>Power Supply (Vcc1, Vcc2, Vcc3)</b>					
Operating Voltage Range		4.5		5.5	V
Supply Current in Normal Mode			106		mA
Supply Current in Power Down Mode			1		mA

[1] Vcc = Vcc1 = Vcc2 = Vcc3 = +5V

### Test Conditions

Parameter	Condition
Vcc1 = Vcc2 = Vcc3	+5V
Input Zo - w/ 68 Ω Term Resistor at IN+	50 Ω
T <sub>A</sub>	+25 C
Fin	900 MHz
IN- Port connected to ground through a 1000pF capacitor	

### Component Values Used at Key Application Frequencies with Vcc = +5V

Component	Frequency (MHz)										
	50	100	900	1900	2200	3600	5800	7000	7500	8000	10000
R8	3900Ω	3900Ω	3900Ω	3900Ω	3900Ω	1100Ω	3900Ω	3900Ω	3900Ω	0Ω	0Ω
C1	100nF	100nF	1000pF	1000pF	1000pF	1000pF	1000pF	1000pF	1000pF	1000pF	1000pF
C2	100nF	100nF	1000pF	1000pF	1000pF	1000pF	1000pF	1000pF	1000pF	1000pF	1000pF

### LOGOUT Voltage & Error vs. Input Power, Fin = 50 MHz

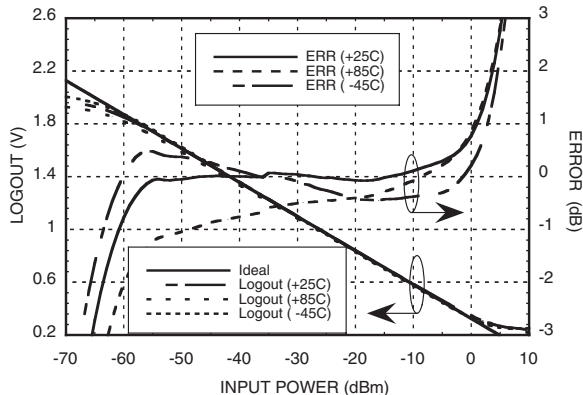

### LOGOUT Voltage & Error vs. Input Power, Fin = 100 MHz

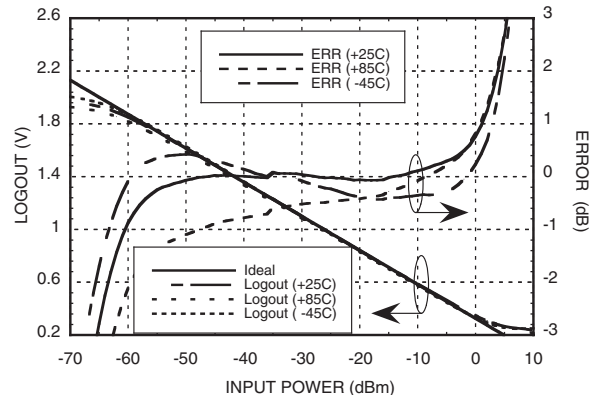

Unless otherwise noted: Vcc1, Vcc2, Vcc3 = +5V, T<sub>A</sub> = +25C

For price, delivery, and to place orders, please contact Hittite Microwave Corporation:  
20 Alpha Road, Chelmsford, MA 01824 Phone: 978-250-3343 Fax: 978-250-3373  
Order On-line at [www.hittite.com](http://www.hittite.com)

**LOGOUT Voltage & Error vs. Input Power,  $f_{in} = 900$  MHz**

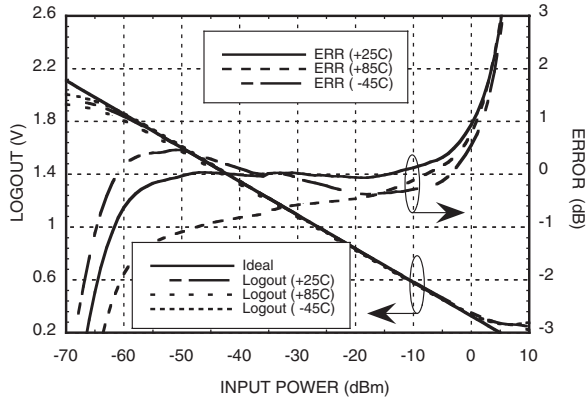

**LOGOUT Voltage & Error vs. Input Power,  $f_{in} = 1900$  MHz**

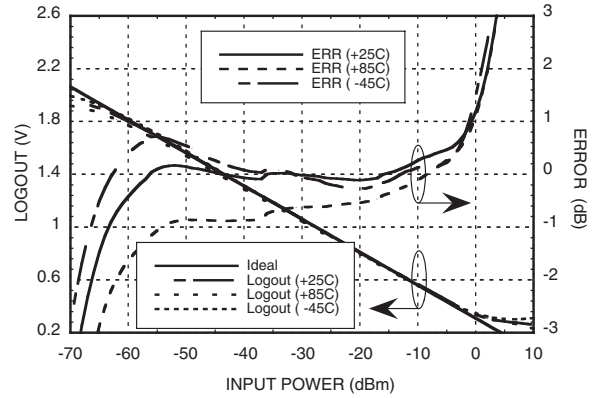

**LOGOUT Voltage & Error vs. Input Power,  $f_{in} = 2200$  MHz**

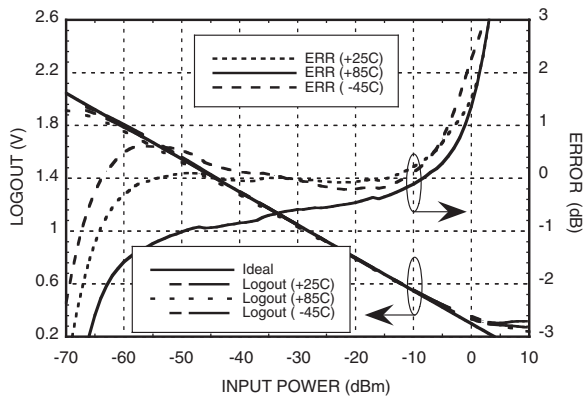

**LOGOUT Voltage & Error vs. Input Power,  $f_{in} = 3600$  MHz**

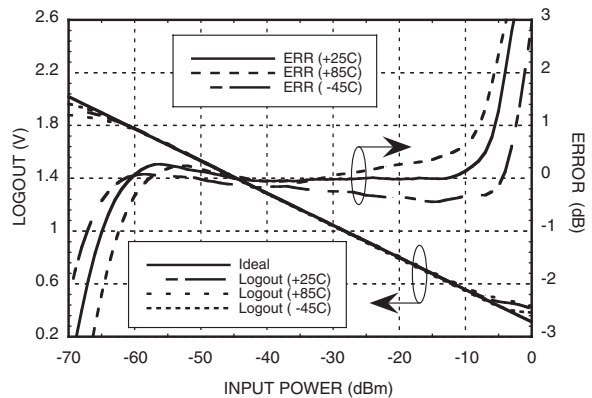

**LOGOUT Voltage & Error vs. Input Power,  $f_{in} = 5800$  MHz**

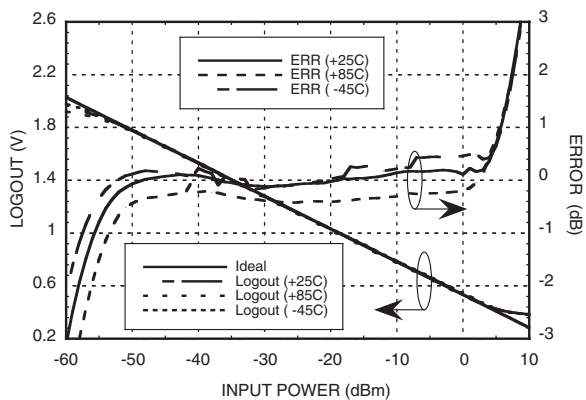

**LOGOUT Voltage & Error vs. Input Power,  $f_{in} = 7000$  MHz**

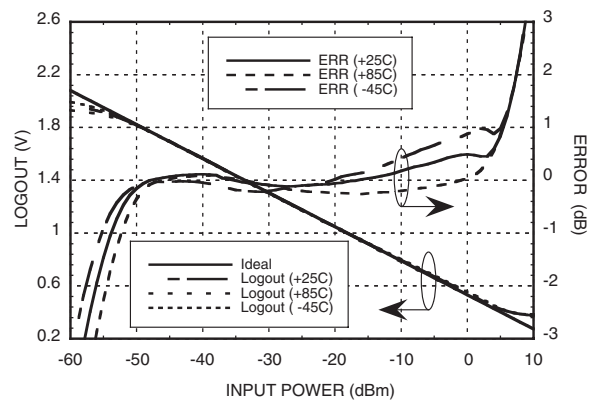

Unless otherwise noted:  $V_{cc1}, V_{cc2}, V_{cc3} = +5V, T_A = +25C$

For price, delivery, and to place orders, please contact Hittite Microwave Corporation:  
 20 Alpha Road, Chelmsford, MA 01824 Phone: 978-250-3343 Fax: 978-250-3373  
 Order On-line at [www.hittite.com](http://www.hittite.com)

**LOGOUT Voltage & Error vs. Input Power,  $f_{in} = 7500$  MHz**

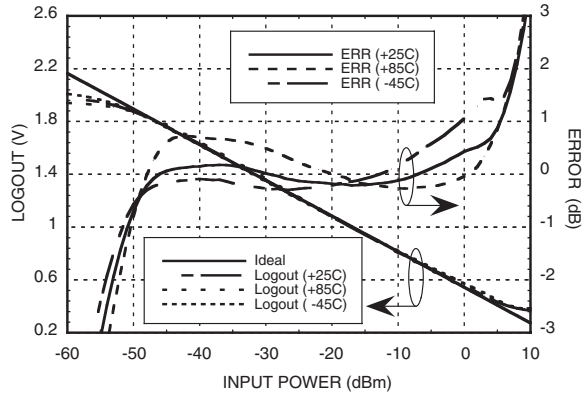

**LOGOUT Voltage & Error vs. Input Power,  $f_{in} = 8000$  MHz**

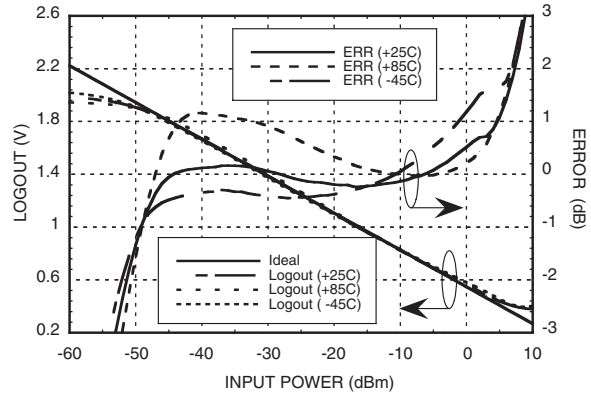

**LOGOUT Voltage & Error vs. Input Power,  $f_{in} = 10000$  MHz**

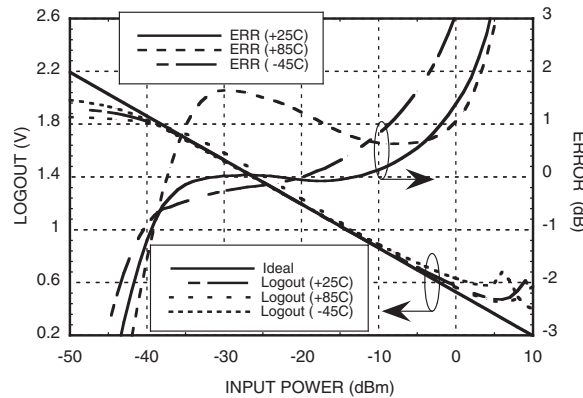

**LOGOUT Slope vs. Frequency**

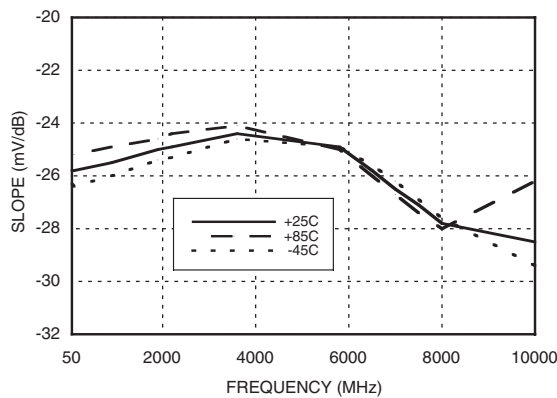

**LOGOUT Slope vs. Supply Voltage**

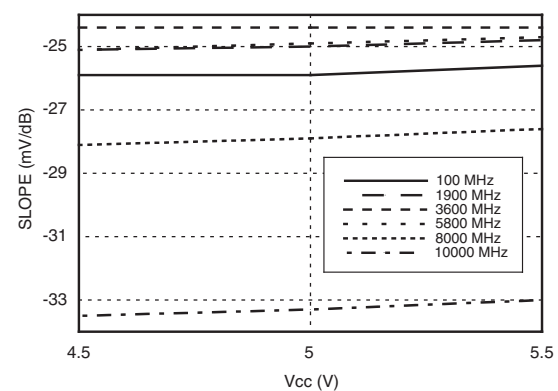

Unless otherwise noted:  $V_{cc1}, V_{cc2}, V_{cc3} = +5V, T_A = +25C$

For price, delivery, and to place orders, please contact Hittite Microwave Corporation:  
 20 Alpha Road, Chelmsford, MA 01824 Phone: 978-250-3343 Fax: 978-250-3373  
 Order On-line at [www.hittite.com](http://www.hittite.com)



**LOGOUT Intercept vs. Frequency**

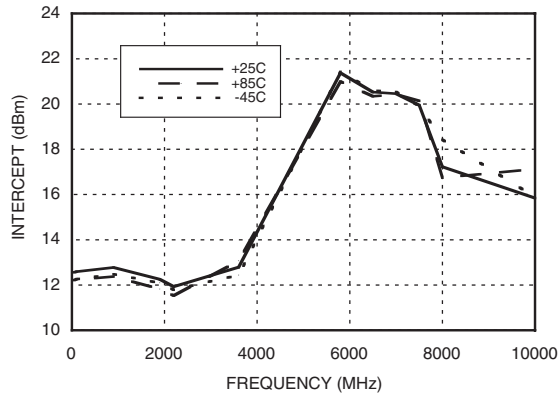

**LOGOUT Intercept vs. Supply Voltage**

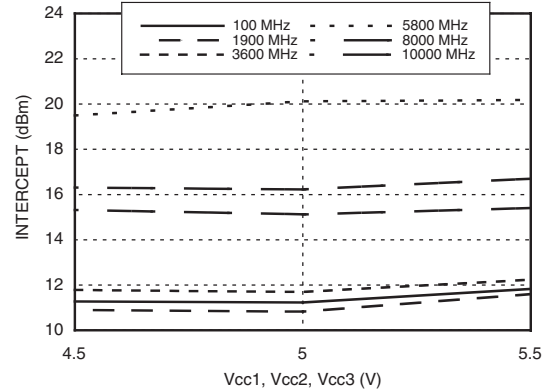

**LOGOUT Error vs. Input Power, Normalized [2], Fin= 1900 MHz**

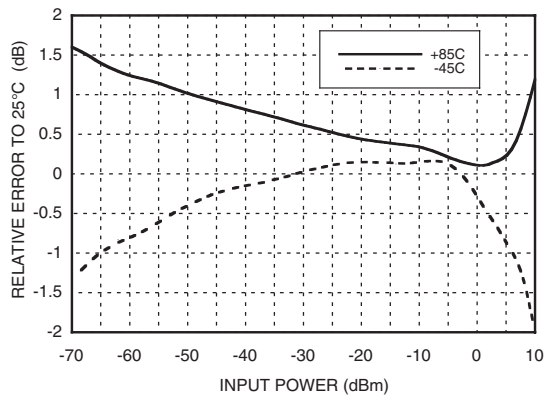

**Input Impedance vs Frequency [3]**

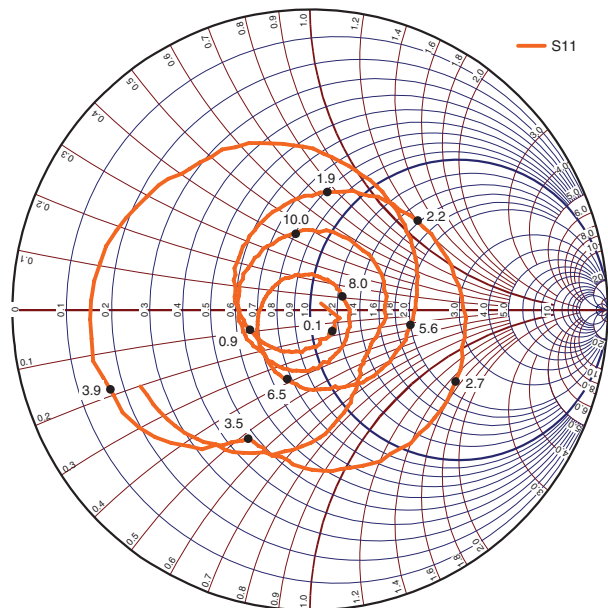

**LOGOUT Voltage vs. Input Power & Frequency**

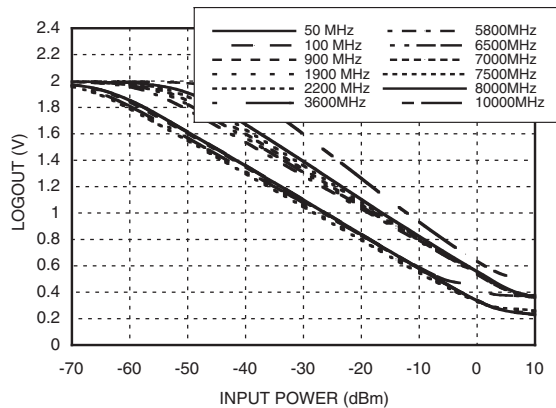

[1] Unless otherwise noted: Vcc1, Vcc2, Vcc3 = +5V, TA = +25C  
 [2] This data is relative to the room temperature performance of the HMC611LP4(E)  
 [3] Reference plane at J1 connector on eval board

### Absolute Maximum Ratings

Vcc1, Vcc2, Vcc3	+5.6V
EN	+5.6V
VSET Input Voltage	+5.6V
LOGOUT Output Current	3 mA
RF Input Power	+15 dBm
Junction Temperature	125 °C
Continuous Pdiss (T = 85°C) (Derate 7.95 mW/°C above 85°C)	1.55 Watts
Thermal Resistance (R <sub>th</sub> ) (junction to lead)	42 °C/W
Storage Temperature	-65 to +150 °C
Operating Temperature	-40 to +85 °C



ELECTROSTATIC SENSITIVE DEVICE  
OBSERVE HANDLING PRECAUTIONS

### Outline Drawing

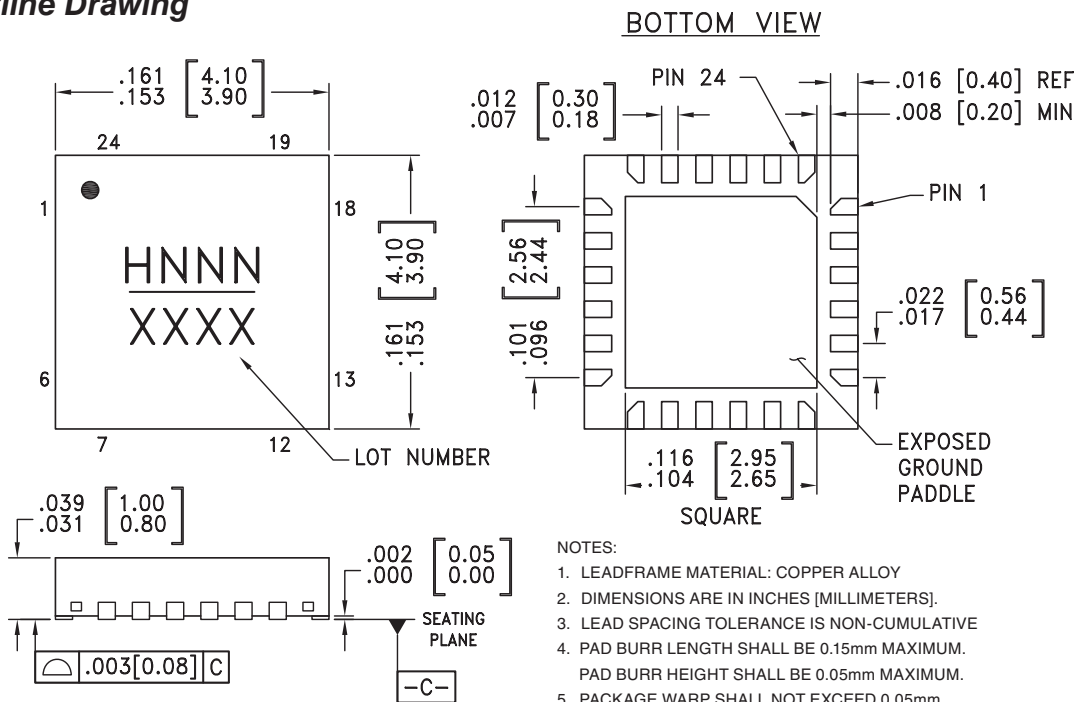

NOTES:

- LEADFRAME MATERIAL: COPPER ALLOY
- DIMENSIONS ARE IN INCHES [MILLIMETERS].
- LEAD SPACING TOLERANCE IS NON-CUMULATIVE
- PAD BURR LENGTH SHALL BE 0.15mm MAXIMUM.  
PAD BURR HEIGHT SHALL BE 0.05mm MAXIMUM.
- PACKAGE WARP SHALL NOT EXCEED 0.05mm.
- ALL GROUND LEADS AND GROUND PADDLE MUST BE SOLDERED TO PCB RF GROUND.
- REFER TO HMC APPLICATION NOTE FOR SUGGESTED PCB LAND PATTERN.

### Package Information

Part Number	Package Body Material	Lead Finish	MSL Rating	Package Marking <sup>[3]</sup>
HMC611LP4	Low Stress Injection Molded Plastic	Sn/Pb Solder	MSL1 <sup>[1]</sup>	H611 XXXX
HMC611LP4E	RoHS-compliant Low Stress Injection Molded Plastic	100% matte Sn	MSL1 <sup>[2]</sup>	H611 XXXX

[1] Max peak reflow temperature of 235 °C

[2] Max peak reflow temperature of 260 °C

[3] 4-Digit lot number XXXX



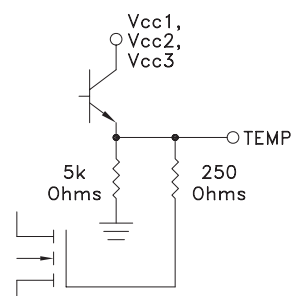
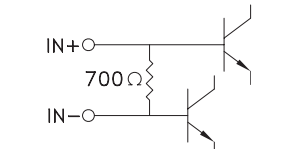
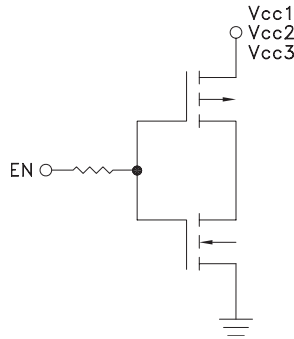
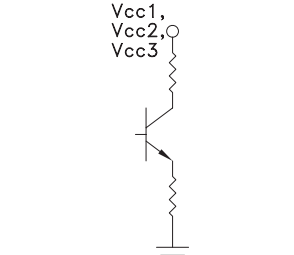
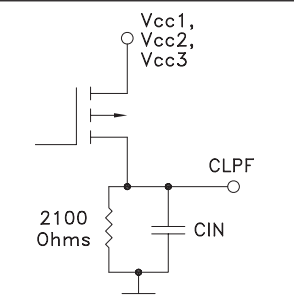

**Pin Descriptions**

Pin Number	Function	Description	Interface Schematic
1, 6, 7, 13, 17, 18	N/C	These pins are not connected internally; however, this product is specified with these pins connected to RF/DC ground.	
2	TEMP	Temperature sensor output pin	
3, 4	IN+, IN-	RF Input pins. Connect RF to IN+, and AC couple IN- to ground for single-ended operation.	
5	EN	Enable pin, connect to Vcc1, Vcc2, Vcc3 for normal operation. Applying voltage $<0.2 \times (V_{cc1}, V_{cc2}, V_{cc3})$ will initiate power saving mode.	
8 - 12, 19, 20, 23, 24	Vcc1, Vcc2, Vcc3	Bias supply. Connect supply voltage to these pins with appropriate filtering.	
14	CLPF	Loop filter capacitor for output ripple filtering.	

For price, delivery, and to place orders, please contact Hittite Microwave Corporation:  
20 Alpha Road, Chelmsford, MA 01824 Phone: 978-250-3343 Fax: 978-250-3373  
Order On-line at [www.hittite.com](http://www.hittite.com)

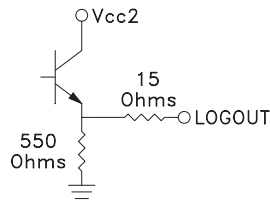
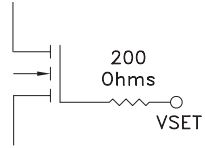
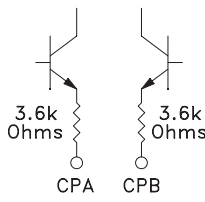

### Pin Descriptions (Continued)

Pin Number	Function	Description	Interface Schematic
15	LOGOUT	Logarithmic output that converts the input power to a DC level in detector mode. Short this pin to VSET for detector mode.	
16	VSET	VSET input in controller mode. Short this pin to LOGOUT for detector mode.	
21, 22	CPB, CPA	Temperature compensation pins.	
Package Base	GND	Exposed paddle must be connected to RF and DC ground.	



### Application & Evaluation PCB Schematic

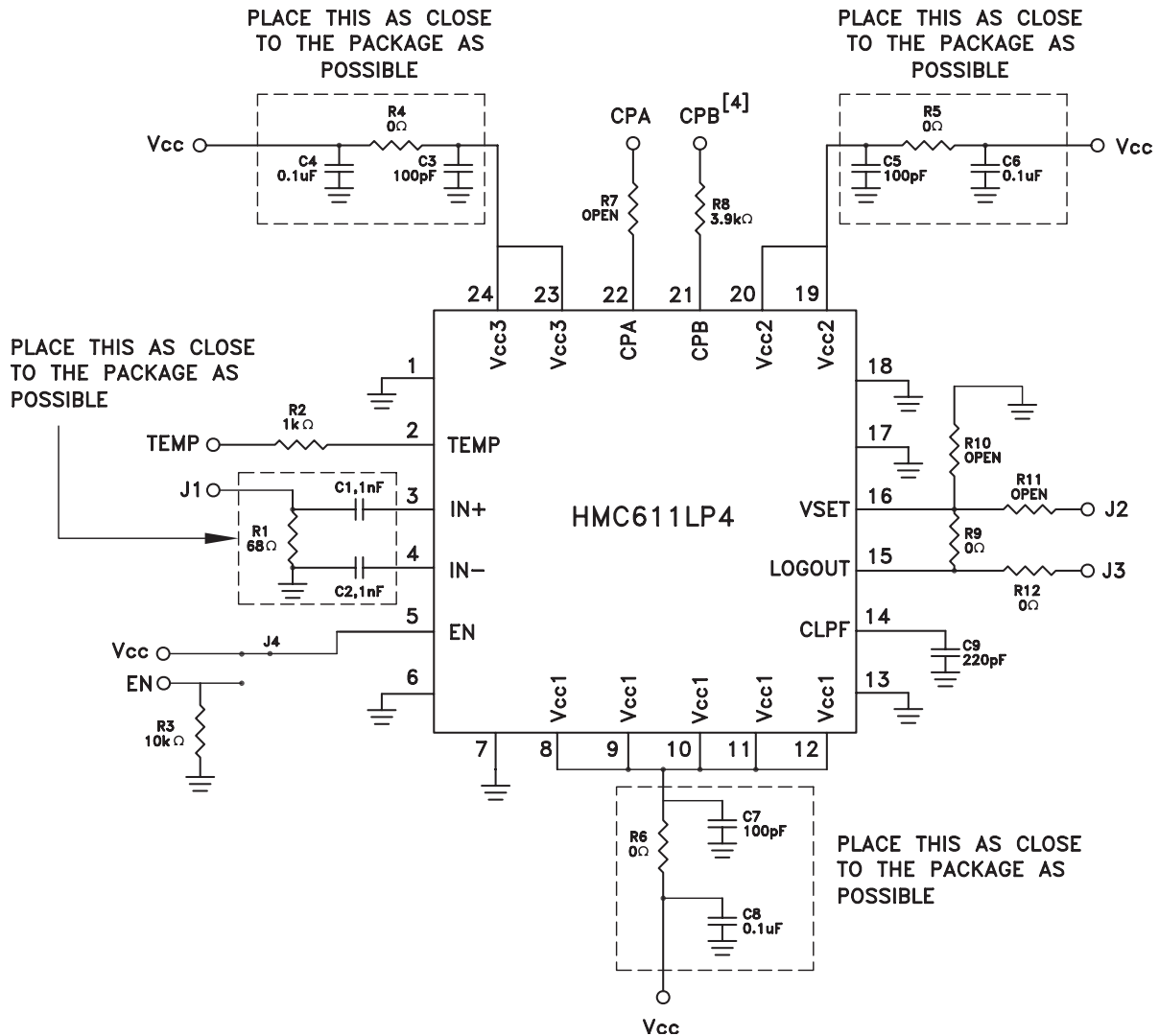

**Notes**

- Note 1: The HMC611LP4 & HMC611LP4E evaluation boards are pre-assembled for single-ended input, and detector/RSSI mode.
- Note 2: For detector mode, connect high impedance volt meter to the LOGOUT port, and make no connection to VSET. LOGOUT is shorted to VSET by R9, as required for detector mode.
- Note 3: For controller mode, remove R9 and install 0 ohm resistor (R11), then make appropriate connection to LOGOUT and VSET. In controller mode, the LOGOUT output can be used to drive a variable gain amplifier, or a variable attenuator, either directly or through a buffer or microcontroller. VSET should be connected to an external supply, typically between +0.6 and +1.9V.
- Note 4: Terminal CPB must be connected to ground for proper operation.

For price, delivery, and to place orders, please contact Hittite Microwave Corporation:  
 20 Alpha Road, Chelmsford, MA 01824 Phone: 978-250-3343 Fax: 978-250-3373  
 Order On-line at [www.hittite.com](http://www.hittite.com)

### Evaluation PCB

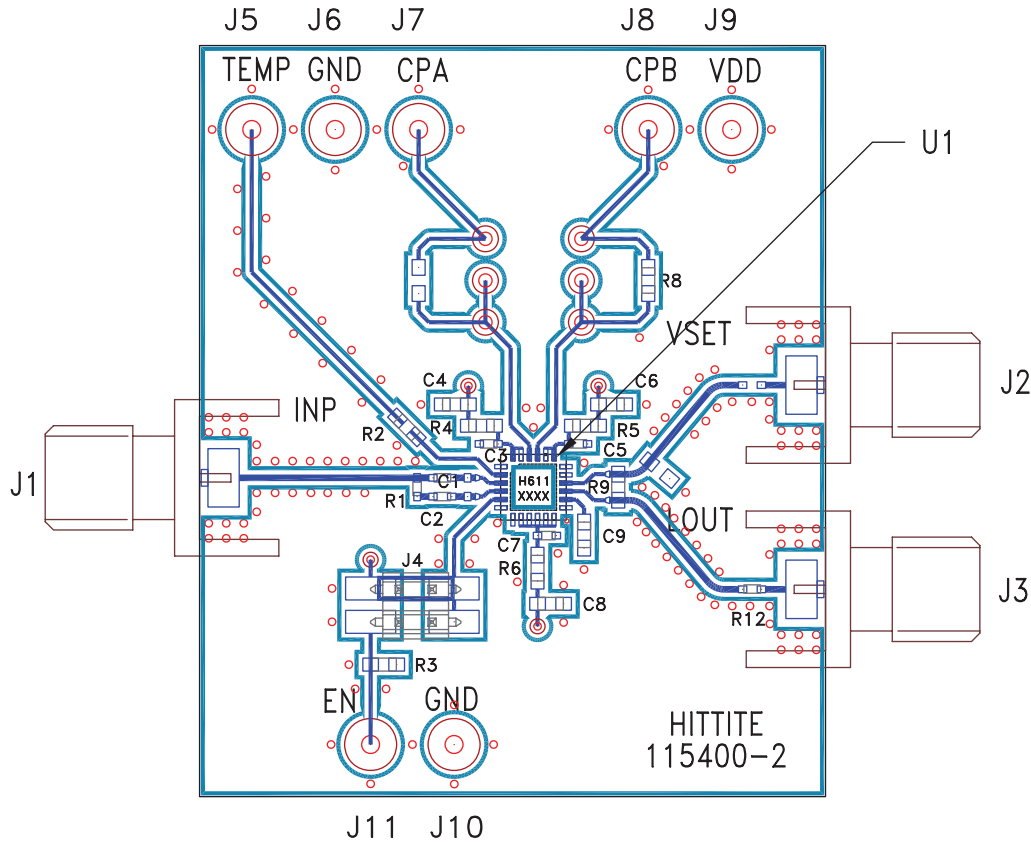

### List of Materials for Evaluation PCB 118154 [1]

Item	Description
J1 - J3	PC Mount SMA Connector
J4	Molex Connector Header
J5 - J11	DC Pin
C1, C2	1000 pF Capacitor, 0402 Pkg.
C3, C5, C7	100 pF Capacitor, 0402 Pkg.
C4, C6, C8	0.1µF Capacitor, 0603 Pkg.
C9	220 pF Capacitor, 0603 Pkg.
R1	68Ω Resistor, 0603 Pkg.
R2	1k Ω Resistor, 0603 Pkg.
R3	10k Ω Resistor, 0603 Pkg.
R4 - R6, R9	0Ω Resistor, 0603 Pkg.
R8	3.9KΩ Resistor, 0603 Pkg.
R12	0Ω Resistor, 0402 Pkg.
U1	HMC602LP4 / HMC602LP4E Logarithmic Detector / Controller
PCB [2]	115400 Eval Board

[1] Reference this number when ordering complete evaluation PCB

[2] Circuit Board Material: Rogers 4350

The circuit board used in the final application should use RF circuit design techniques. Signal lines should have 50 ohm impedance while the package ground leads and exposed paddle should be connected directly to the ground plane similar to that shown. A sufficient number of via holes should be used to connect the top and bottom ground planes. The evaluation circuit board shown is available from Hittite upon request.



## Стандарт Электрон Связь

Мы молодая и активно развивающаяся компания в области поставок электронных компонентов. Мы поставляем электронные компоненты отечественного и импортного производства напрямую от производителей и с крупнейших складов мира.

Благодаря сотрудничеству с мировыми поставщиками мы осуществляем комплексные и плановые поставки широчайшего спектра электронных компонентов.

Собственная эффективная логистика и склад в обеспечивает надежную поставку продукции в точно указанные сроки по всей России.

Мы осуществляем техническую поддержку нашим клиентам и предпродажную проверку качества продукции. На все поставляемые продукты мы предоставляем гарантию .

Осуществляем поставки продукции под контролем ВП МО РФ на предприятия военно-промышленного комплекса России , а также работаем в рамках 275 ФЗ с открытием отдельных счетов в уполномоченном банке. Система менеджмента качества компании соответствует требованиям ГОСТ ISO 9001.

Минимальные сроки поставки, гибкие цены, неограниченный ассортимент и индивидуальный подход к клиентам являются основой для выстраивания долгосрочного и эффективного сотрудничества с предприятиями радиоэлектронной промышленности, предприятиями ВПК и научно-исследовательскими институтами России.

С нами вы становитесь еще успешнее!

### Наши контакты:

**Телефон:** +7 812 627 14 35

**Электронная почта:** [sales@st-electron.ru](mailto:sales@st-electron.ru)

**Адрес:** 198099, Санкт-Петербург,  
Промышленная ул, дом № 19, литера Н,  
помещение 100-Н Офис 331