

Utilizing the latest Field Stop and Trench Gate technologies, these IGBTs have ultra low $V_{CE(ON)}$ and are ideal for low frequency applications that require absolute minimum conduction loss. Easy paralleling is a result of very tight parameter distribution and a slightly positive $V_{CE(ON)}$ temperature coefficient. A built-in gate resistor ensures extremely reliable operation, even in the event of a short circuit fault. Low gate charge simplifies gate drive design and minimizes losses.

- **600V Field Stop**
- **Trench Gate: Low $V_{CE(on)}$**
- **Easy Paralleling**
- **10 μ s Short Circuit Capability**
- **Intergrated Gate Resistor: Low EMI, High Reliability**

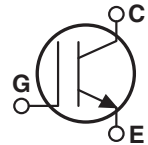

Applications: welding, inductive heating, solar inverters, motor drives, UPS, pass transistor

MAXIMUM RATINGS

All Ratings: $T_C = 25^\circ\text{C}$ unless otherwise specified.

Symbol	Parameter	APT200GN60J	UNIT
V_{CES}	Collector-Emitter Voltage	600	Volts
V_{GE}	Gate-Emitter Voltage	± 20	
I_{C1}	Continuous Collector Current @ $T_C = 25^\circ\text{C}$	250	Amps
I_{C2}	Continuous Collector Current @ $T_C = 110^\circ\text{C}$	110	
I_{CM}	Pulsed Collector Current ^① @ $T_C = 150^\circ\text{C}$	600	
SSOA	Switching Safe Operating Area @ $T_J = 150^\circ\text{C}$	600A @ 600V	
P_D	Total Power Dissipation	568	Watts
T_J, T_{STG}	Operating and Storage Junction Temperature Range	-55 to 150	$^\circ\text{C}$

STATIC ELECTRICAL CHARACTERISTICS

Symbol	Characteristic / Test Conditions	MIN	TYP	MAX	UNIT
$V_{(BR)CES}$	Collector-Emitter Breakdown Voltage ($V_{GE} = 0\text{V}, I_C = 4\text{mA}$)	600			Volts
$V_{GE(TH)}$	Gate Threshold Voltage ($V_{CE} = V_{GE}, I_C = 3.2\text{mA}, T_J = 25^\circ\text{C}$)	5	5.8	6.5	
$V_{CE(ON)}$	Collector-Emitter On Voltage ($V_{GE} = 15\text{V}, I_C = 200\text{A}, T_J = 25^\circ\text{C}$)	1.05	1.45	1.85	
	Collector-Emitter On Voltage ($V_{GE} = 15\text{V}, I_C = 200\text{A}, T_J = 125^\circ\text{C}$)		1.65		
	Collector-Emitter On Voltage ($V_{GE} = 15\text{V}, I_C = 100\text{A}, T_J = 25^\circ\text{C}$)		1.15		
	Collector-Emitter On Voltage ($V_{GE} = 15\text{V}, I_C = 100\text{A}, T_J = 125^\circ\text{C}$)		1.19		
I_{CES}	Collector Cut-off Current ($V_{CE} = 600\text{V}, V_{GE} = 0\text{V}, T_J = 25^\circ\text{C}$) ^②			4	mA
	Collector Cut-off Current ($V_{CE} = 600\text{V}, V_{GE} = 0\text{V}, T_J = 125^\circ\text{C}$) ^②			TBD	
I_{GES}	Gate-Emitter Leakage Current ($V_{GE} = \pm 20\text{V}$)			600	nA
R_{GINT}	Intergrated Gate Resistor		2		Ω

 **CAUTION:** These Devices are Sensitive to Electrostatic Discharge. Proper Handling Procedures Should Be Followed.

APT Website - <http://www.advancedpower.com>

DYNAMIC CHARACTERISTICS

APT200GN60J

Symbol	Characteristic	Test Conditions	MIN	TYP	MAX	UNIT
C _{ies}	Input Capacitance	Capacitance V _{GE} = 0V, V _{CE} = 25V f = 1 MHz		14100		pF
C _{oes}	Output Capacitance			4610		
C _{res}	Reverse Transfer Capacitance			4000		
V _{GEP}	Gate-to-Emitter Plateau Voltage	Gate Charge		8.2		V
Q _g	Total Gate Charge ^③	V _{GE} = 15V		1180		nC
Q _{ge}	Gate-Emitter Charge	V _{CE} = 300V		85		
Q _{gc}	Gate-Collector ("Miller") Charge	I _C = 100A		660		
SSOA	Switching Safe Operating Area	T _J = 150°C, R _G = 5Ω ^⑦ , V _{GE} = 15V, L = 100μH, V _{CE} = 600V	600			A
SCSOA	Short Circuit Safe Operating Area	V _{CC} = 480V, V _{GE} = 15V, T _J = 125°C, R _G = 5Ω ^⑦	10			μs
t _{d(on)}	Turn-on Delay Time	Inductive Switching (25°C) V _{CC} = 400V V _{GE} = 15V I _C = 100A R _G = 5Ω ^⑦ T _J = +25°C		55		ns
t _r	Current Rise Time			20		
t _{d(off)}	Turn-off Delay Time			1050		
t _f	Current Fall Time			50		μJ
E _{on1}	Turn-on Switching Energy ^④			TBD		
E _{on2}	Turn-on Switching Energy (Diode) ^⑤			1720		
E _{off}	Turn-off Switching Energy ^⑥		2810			
t _{d(on)}	Turn-on Delay Time	Inductive Switching (125°C) V _{CC} = 400V V _{GE} = 15V I _C = 100A R _G = 5Ω ^⑦ T _J = +125°C		55		ns
t _r	Current Rise Time			20		
t _{d(off)}	Turn-off Delay Time			1150		
t _f	Current Fall Time			60		μJ
E _{on1}	Turn-on Switching Energy ^④			TBD		
E _{on2}	Turn-on Switching Energy (Diode) ^⑤			1955		
E _{off}	Turn-off Switching Energy ^⑥		2865			

THERMAL AND MECHANICAL CHARACTERISTICS

Symbol	Characteristic	MIN	TYP	MAX	UNIT
R _{θJC}	Junction to Case (IGBT)			.22	°C/W
R _{θJC}	Junction to Case (DIODE)			N/A	
V _{Isolation}	RMS Voltage (50-60Hz Sinusoidal Waveform from Terminals to Mounting Base for 1 Min.)	2500			Volts
W _T	Package Weight		1.03		oz
			29.2		gm
Torque	Maximum Terminal & Mounting Torque			10	lb•in
				1.1	N•m

- ① Repetitive Rating: Pulse width limited by maximum junction temperature.
- ② For Combi devices, I_{CES} includes both IGBT and FRED leakage.
- ③ See MIL-STD-750 Method 3471.
- ④ E_{on1} is the clamped inductive turn-on energy of the IGBT only, without the effect of a commutating diode reverse recovery current adding to the IGBT turn-on loss. (See Figure 24)
- ⑤ E_{on2} is the clamped inductive turn-on energy that includes a commutating diode reverse recovery current in the IGBT turn-on switching loss. (See Figures 21, 22)
- ⑥ E_{off} is the clamped inductive turn-off energy measured in accordance with JEDEC standard JESD24-1. (See Figures 21, 23)
- ⑦ R_G is external gate resistance, not including R_{Gint} nor gate driver impedance. (MIC4452)

APT Reserves the right to change, without notice, the specifications and information contained herein.

TYPICAL PERFORMANCE CURVES

APT200GN60J

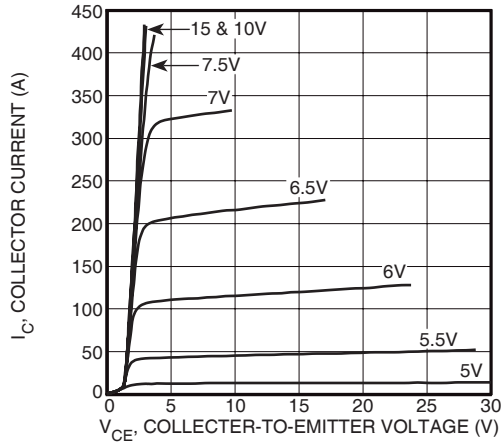

FIGURE 1, Output Characteristics ($T_J = 25^\circ\text{C}$)

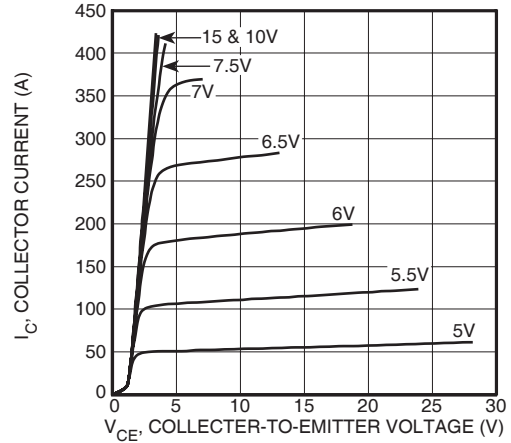

FIGURE 2, Output Characteristics ($T_J = 125^\circ\text{C}$)

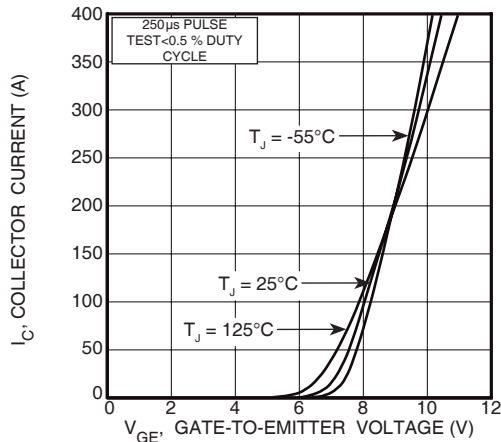

FIGURE 3, Transfer Characteristics

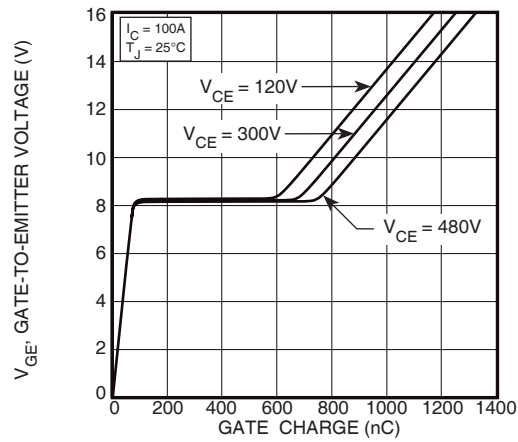

FIGURE 4, Gate Charge

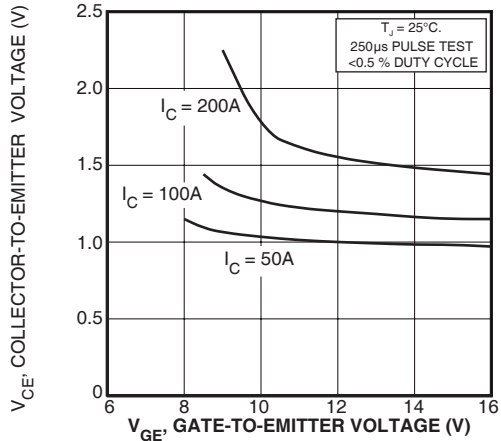

FIGURE 5, On State Voltage vs Gate-to-Emitter Voltage

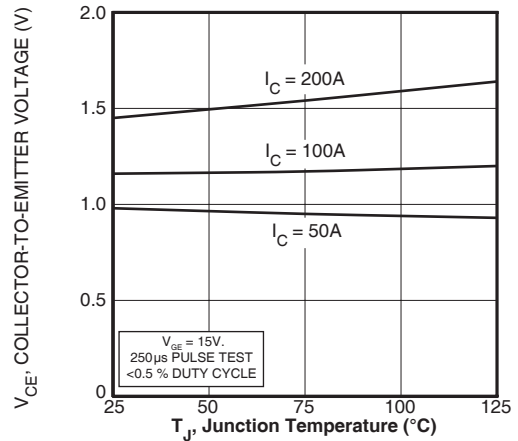

FIGURE 6, On State Voltage vs Junction Temperature

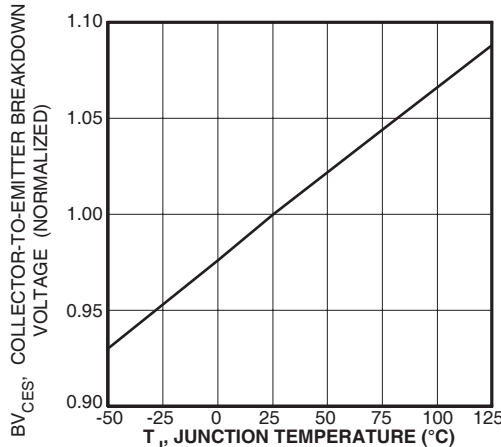

FIGURE 7, Breakdown Voltage vs. Junction Temperature

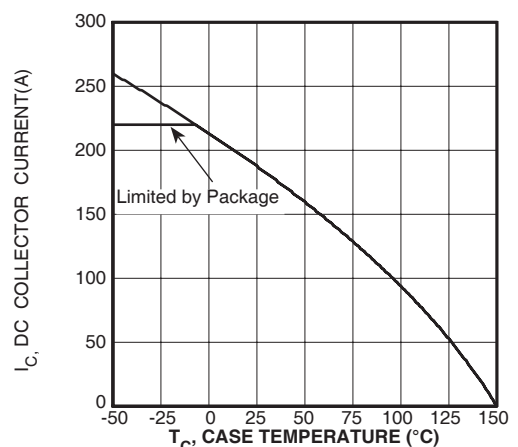

FIGURE 8, DC Collector Current vs Case Temperature

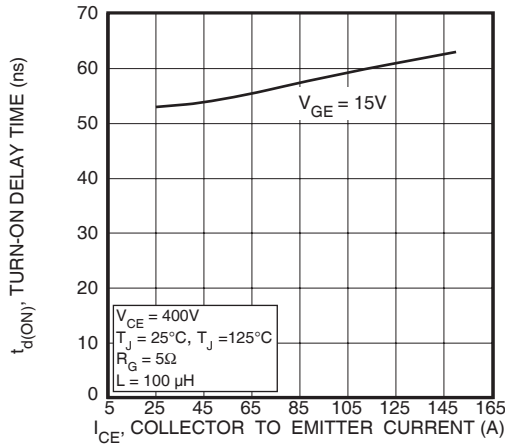

FIGURE 9, Turn-On Delay Time vs Collector Current

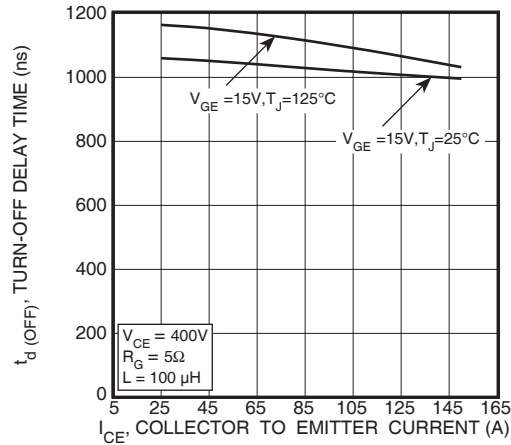

FIGURE 10, Turn-Off Delay Time vs Collector Current

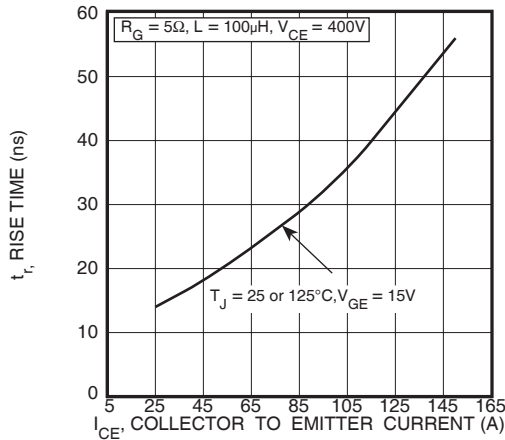

FIGURE 11, Current Rise Time vs Collector Current

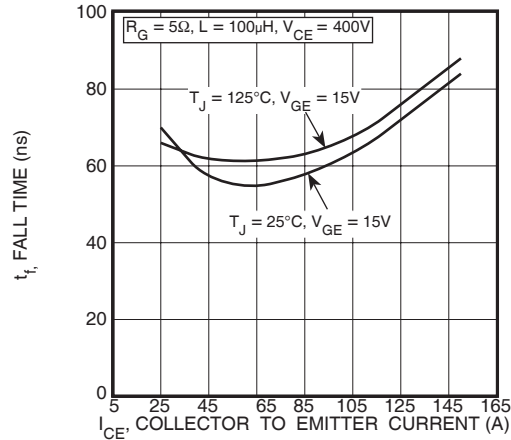

FIGURE 12, Current Fall Time vs Collector Current

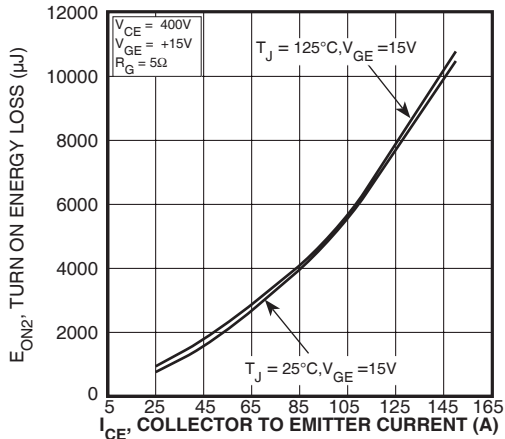

FIGURE 13, Turn-On Energy Loss vs Collector Current

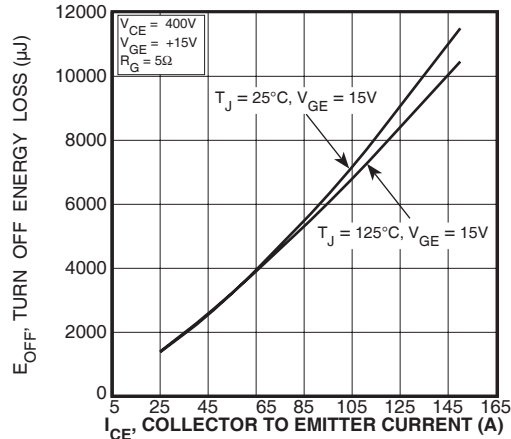

FIGURE 14, Turn Off Energy Loss vs Collector Current

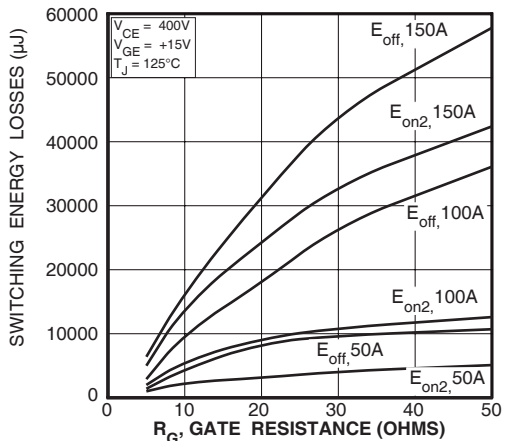

FIGURE 15, Switching Energy Losses vs. Gate Resistance

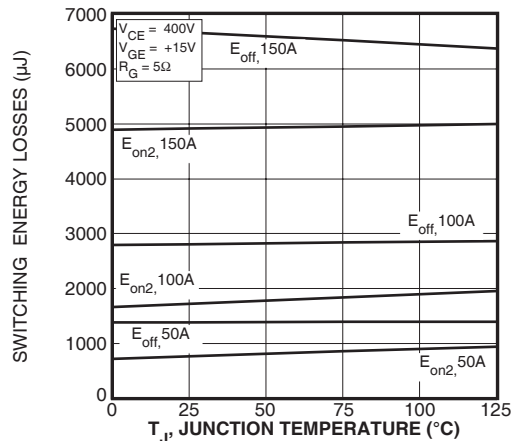

FIGURE 16, Switching Energy Losses vs Junction Temperature

TYPICAL PERFORMANCE CURVES

APT200GN60J

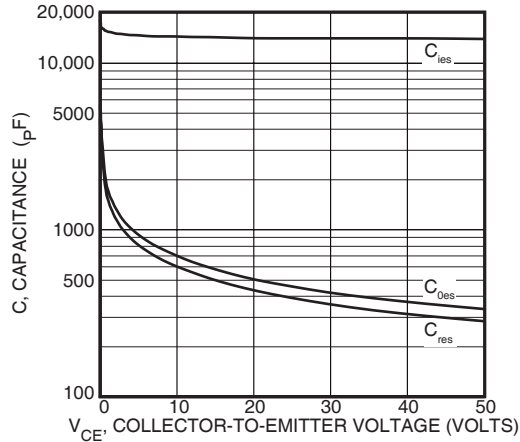

Figure 17, Capacitance vs Collector-To-Emitter Voltage

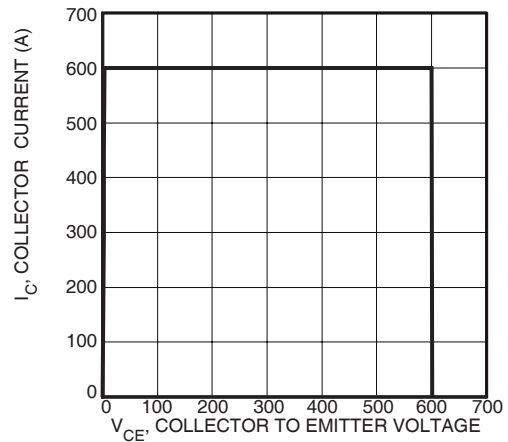

Figure 18, Minimum Switching Safe Operating Area

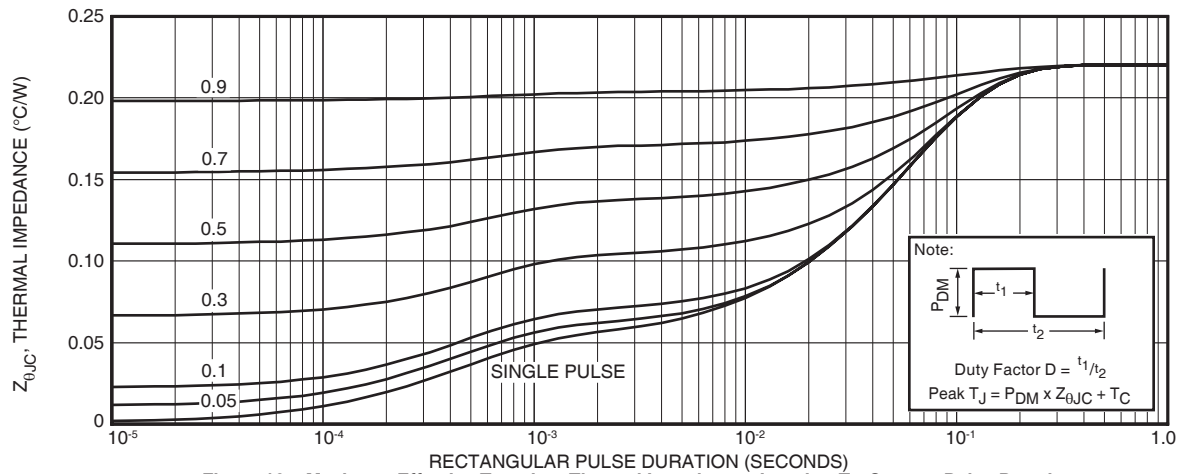

Figure 19a, Maximum Effective Transient Thermal Impedance, Junction-To-Case vs Pulse Duration

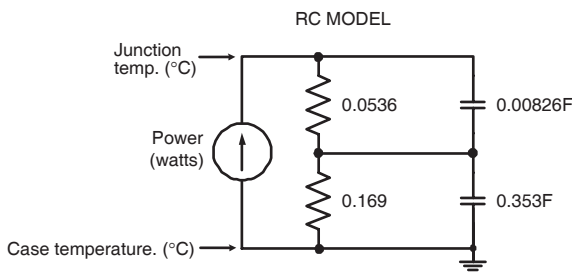

FIGURE 19b, TRANSIENT THERMAL IMPEDANCE MODEL

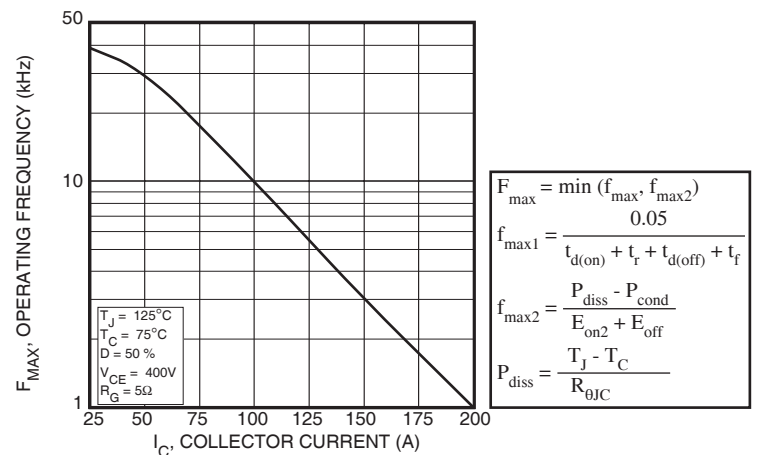

Figure 20, Operating Frequency vs Collector Current

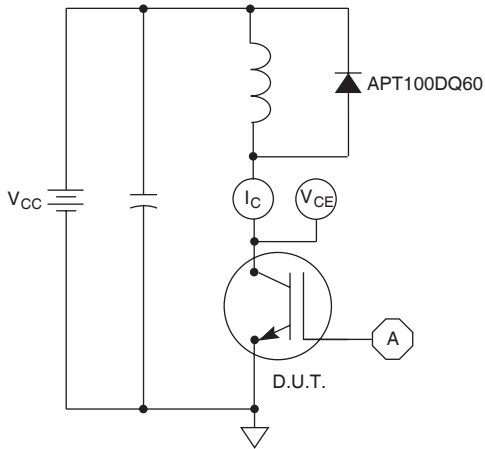

Figure 21, Inductive Switching Test Circuit

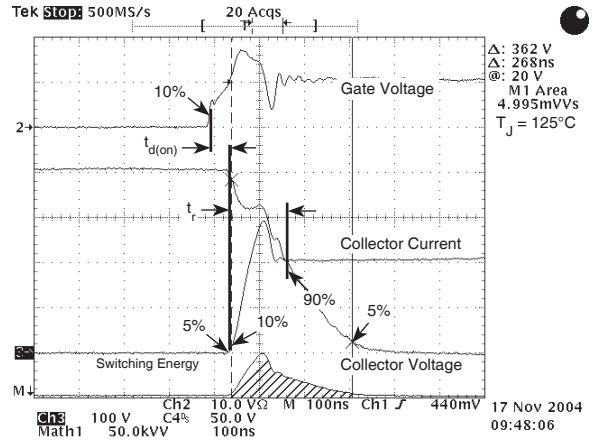

Figure 22, Turn-on Switching Waveforms and Definitions

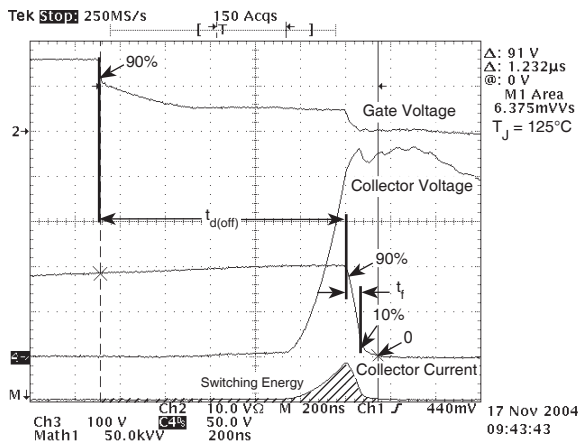

Figure 23, Turn-off Switching Waveforms and Definitions

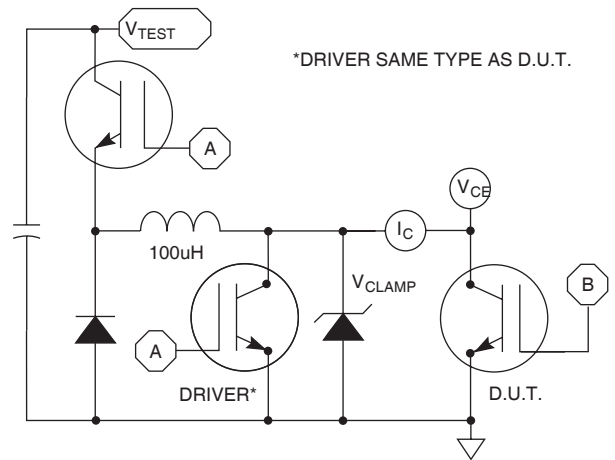
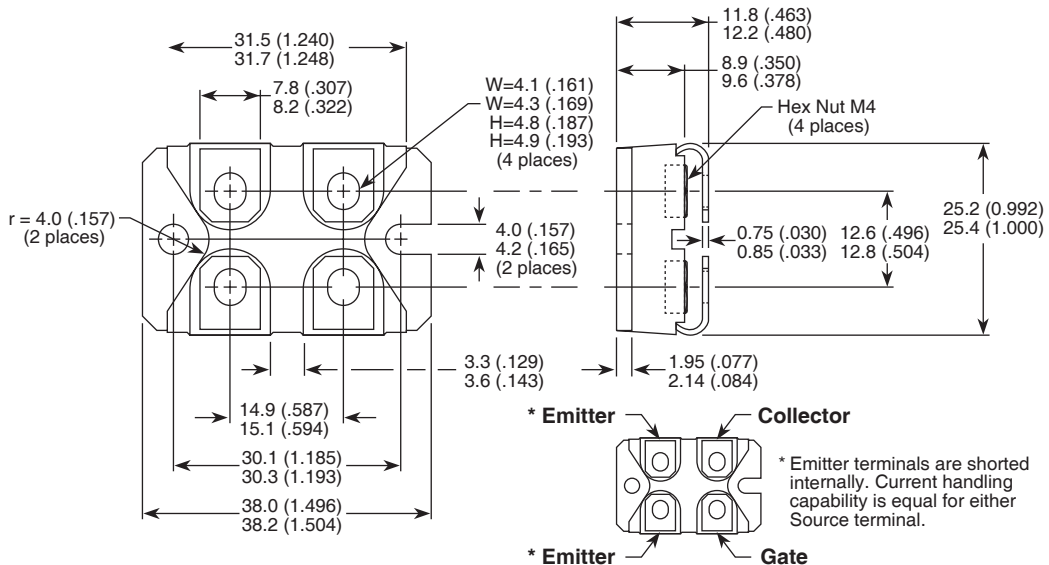

Figure 24, EON1 Test Circuit

SOT-227 (ISOTOP®) Package Outline



Dimensions in Millimeters and (Inches)



Стандарт Электрон Связь

Мы молодая и активно развивающаяся компания в области поставок электронных компонентов. Мы поставляем электронные компоненты отечественного и импортного производства напрямую от производителей и с крупнейших складов мира.

Благодаря сотрудничеству с мировыми поставщиками мы осуществляем комплексные и плановые поставки широчайшего спектра электронных компонентов.

Собственная эффективная логистика и склад в обеспечивает надежную поставку продукции в точно указанные сроки по всей России.

Мы осуществляем техническую поддержку нашим клиентам и предпродажную проверку качества продукции. На все поставляемые продукты мы предоставляем гарантию .

Осуществляем поставки продукции под контролем ВП МО РФ на предприятия военно-промышленного комплекса России , а также работаем в рамках 275 ФЗ с открытием отдельных счетов в уполномоченном банке. Система менеджмента качества компании соответствует требованиям ГОСТ ISO 9001.

Минимальные сроки поставки, гибкие цены, неограниченный ассортимент и индивидуальный подход к клиентам являются основой для выстраивания долгосрочного и эффективного сотрудничества с предприятиями радиоэлектронной промышленности, предприятиями ВПК и научно-исследовательскими институтами России.

С нами вы становитесь еще успешнее!

Наши контакты:

Телефон: +7 812 627 14 35

Электронная почта: sales@st-electron.ru

Адрес: 198099, Санкт-Петербург,
Промышленная ул, дом № 19, литера Н,
помещение 100-Н Офис 331