

Trimmer Potentiometers



Lead Sealed Type Multi-turns PV12/PV37/PV23/PV22/PV36 Series

PV12 Series

■ Features

1. The unique inner gear system recognizes the position of the center of the shaft of the potentiometer.
2. Sealed construction protects the interior from dust and liquid, which achieves stable performance.
3. Available for ultrasonic cleaning after soldering
4. Clutch mechanism prevents excessive wiper rotation.

■ Applications

1. HDTVs
2. Professional cameras
3. CATV
4. FAX
5. Printers
6. Sensors
7. Switching power supplies



PV12H



PV12P



PV12S



PV12T



Part Number	Power Rating	Soldering Method	Number of Turns (Effective Rotation Angle)	Total Resistance Value	TCR
PV12□100A01	0.5W(70°C)	Flow/Soldering Iron	4	10ohm ±10%	±100ppm/°C
PV12□200A01	0.5W(70°C)	Flow/Soldering Iron	4	20ohm ±10%	±100ppm/°C
PV12□500A01	0.5W(70°C)	Flow/Soldering Iron	4	50ohm ±10%	±100ppm/°C
PV12□101A01	0.5W(70°C)	Flow/Soldering Iron	4	100ohm ±10%	±100ppm/°C
PV12□201A01	0.5W(70°C)	Flow/Soldering Iron	4	200ohm ±10%	±100ppm/°C
PV12□501A01	0.5W(70°C)	Flow/Soldering Iron	4	500ohm ±10%	±100ppm/°C
PV12□102A01	0.5W(70°C)	Flow/Soldering Iron	4	1k ohm ±10%	±100ppm/°C
PV12□202A01	0.5W(70°C)	Flow/Soldering Iron	4	2k ohm ±10%	±100ppm/°C
PV12□502A01	0.5W(70°C)	Flow/Soldering Iron	4	5k ohm ±10%	±100ppm/°C
PV12□103A01	0.5W(70°C)	Flow/Soldering Iron	4	10k ohm ±10%	±100ppm/°C

Continued on the following page.

Continued from the preceding page.

Part Number	Power Rating	Soldering Method	Number of Turns (Effective Rotation Angle)	Total Resistance Value	TCR
PV12□203A01	0.5W(70°C)	Flow/Soldering Iron	4	20k ohm ±10%	±100ppm/°C
PV12□503A01	0.5W(70°C)	Flow/Soldering Iron	4	50k ohm ±10%	±100ppm/°C
PV12□104A01	0.5W(70°C)	Flow/Soldering Iron	4	100k ohm ±10%	±100ppm/°C
PV12□204A01	0.5W(70°C)	Flow/Soldering Iron	4	200k ohm ±10%	±100ppm/°C
PV12□504A01	0.5W(70°C)	Flow/Soldering Iron	4	500k ohm ±10%	±100ppm/°C
PV12□105A01	0.5W(70°C)	Flow/Soldering Iron	4	1M ohm ±10%	±100ppm/°C
PV12□205A01	0.5W(70°C)	Flow/Soldering Iron	4	2M ohm ±10%	±100ppm/°C

Operating Temperature Range: -55 to 125 °C

The blank column is filled with the code of adjustment direction and lead type (H, P, T and S).

The order quantity should be an integral multiple of the "Minimum Quantity".

Construction



Mounting Holes

PV12H



(Tolerance:±0.1
in mm)

PV12P/PV12S



(Tolerance:±0.1
in mm)

PV12T



(Tolerance:±0.1
in mm)

■ Characteristics

Temperature Cycle	Δ TR	$\pm 2\%$
	Δ V.S.S.	$\pm 1\%$
Humidity	Δ TR	$\pm 2\%$
	IR	100Mohm min.
Vibration (20G)	Δ TR	$\pm 1\%$
	Δ V.S.S.	$\pm 1\%$
Shock (100G)	Δ TR	$\pm 1\%$
	Δ V.S.S.	$\pm 1\%$
Temperature Load Life	Δ TR	$\pm 3\%$
	Δ V.S.S.	$\pm 2\%$
Low Temperature Exposure	Δ TR	$\pm 3\%$
	Δ V.S.S.	$\pm 1.5\%$
High Temperature Exposure	Δ TR	$\pm 3\%$
	Δ V.S.S.	$\pm 1.5\%$
Rotational Life (200 cycles)	Δ TR	$\pm 3\%$

Δ TR : Total Resistance Change
 Δ V.S.S. : Voltage Setting Stability
 IR : Insulation Resistance

PV37 Series

■ Features

1. Smaller volume (about one-third) than 25-turns potentiometer
2. Sealed construction protects the interior from dust and liquid, which achieves stable performance.
3. Available for ultrasonic cleaning after soldering
4. Clutch mechanism prevents excessive wiper rotation.
5. 5 standard terminal styles
6. Both Top and side adjustment directions
7. To be complied with RoHS directive by new Cd free cermet resistive material. Pb free terminals with Sn plating.

■ Applications

1. Measuring instruments
2. OA equipment
3. Medical equipment
4. Power supply
5. Base station for cellular phone



PV37P



PV37W



PV37X



PV37Y



PV37Z



Part Number	Power Rating	Soldering Method	Number of Turns (Effective Rotation Angle)	Total Resistance Value	TCR
PV37□100C01	0.25W(85°C)	Flow/Soldering Iron	12	10ohm ±10%	±150ppm/°C
PV37□200C01	0.25W(85°C)	Flow/Soldering Iron	12	20ohm ±10%	±150ppm/°C
PV37□500C01	0.25W(85°C)	Flow/Soldering Iron	12	50ohm ±10%	±150ppm/°C

Continued on the following page.

Continued from the preceding page.

Part Number	Power Rating	Soldering Method	Number of Turns (Effective Rotation Angle)	Total Resistance Value	TCR
PV37□101C01	0.25W(85°C)	Flow/Soldering Iron	12	100ohm ±10%	±150ppm/°C
PV37□201C01	0.25W(85°C)	Flow/Soldering Iron	12	200ohm ±10%	±150ppm/°C
PV37□501C01	0.25W(85°C)	Flow/Soldering Iron	12	500ohm ±10%	±150ppm/°C
PV37□102C01	0.25W(85°C)	Flow/Soldering Iron	12	1k ohm ±10%	±150ppm/°C
PV37□202C01	0.25W(85°C)	Flow/Soldering Iron	12	2k ohm ±10%	±150ppm/°C
PV37□502C01	0.25W(85°C)	Flow/Soldering Iron	12	5k ohm ±10%	±150ppm/°C
PV37□103C01	0.25W(85°C)	Flow/Soldering Iron	12	10k ohm ±10%	±150ppm/°C
PV37□203C01	0.25W(85°C)	Flow/Soldering Iron	12	20k ohm ±10%	±150ppm/°C
PV37□253C01	0.25W(85°C)	Flow/Soldering Iron	12	25k ohm ±10%	±150ppm/°C
PV37□503C01	0.25W(85°C)	Flow/Soldering Iron	12	50k ohm ±10%	±150ppm/°C
PV37□104C01	0.25W(85°C)	Flow/Soldering Iron	12	100k ohm ±10%	±150ppm/°C
PV37□204C01	0.25W(85°C)	Flow/Soldering Iron	12	200k ohm ±10%	±150ppm/°C
PV37□254C01	0.25W(85°C)	Flow/Soldering Iron	12	250k ohm ±10%	±150ppm/°C
PV37□504C01	0.25W(85°C)	Flow/Soldering Iron	12	500k ohm ±10%	±150ppm/°C
PV37□105C01	0.25W(85°C)	Flow/Soldering Iron	12	1M ohm ±10%	±150ppm/°C
PV37□205C01	0.25W(85°C)	Flow/Soldering Iron	12	2M ohm ±10%	±150ppm/°C
PV37□100C31	0.25W(85°C)	Flow/Soldering Iron	12	10ohm ±10%	±150ppm/°C
PV37□200C31	0.25W(85°C)	Flow/Soldering Iron	12	20ohm ±10%	±150ppm/°C
PV37□500C31	0.25W(85°C)	Flow/Soldering Iron	12	50ohm ±10%	±150ppm/°C
PV37□101C31	0.25W(85°C)	Flow/Soldering Iron	12	100ohm ±10%	±150ppm/°C
PV37□201C31	0.25W(85°C)	Flow/Soldering Iron	12	200ohm ±10%	±150ppm/°C
PV37□501C31	0.25W(85°C)	Flow/Soldering Iron	12	500ohm ±10%	±150ppm/°C
PV37□102C31	0.25W(85°C)	Flow/Soldering Iron	12	1k ohm ±10%	±150ppm/°C
PV37□202C31	0.25W(85°C)	Flow/Soldering Iron	12	2k ohm ±10%	±150ppm/°C
PV37□502C31	0.25W(85°C)	Flow/Soldering Iron	12	5k ohm ±10%	±150ppm/°C
PV37□103C31	0.25W(85°C)	Flow/Soldering Iron	12	10k ohm ±10%	±150ppm/°C
PV37□203C31	0.25W(85°C)	Flow/Soldering Iron	12	20k ohm ±10%	±150ppm/°C
PV37□253C31	0.25W(85°C)	Flow/Soldering Iron	12	25k ohm ±10%	±150ppm/°C
PV37□503C31	0.25W(85°C)	Flow/Soldering Iron	12	50k ohm ±10%	±150ppm/°C
PV37□104C31	0.25W(85°C)	Flow/Soldering Iron	12	100k ohm ±10%	±150ppm/°C
PV37□204C31	0.25W(85°C)	Flow/Soldering Iron	12	200k ohm ±10%	±150ppm/°C
PV37□254C31	0.25W(85°C)	Flow/Soldering Iron	12	250k ohm ±10%	±150ppm/°C
PV37□504C31	0.25W(85°C)	Flow/Soldering Iron	12	500k ohm ±10%	±150ppm/°C
PV37□105C31	0.25W(85°C)	Flow/Soldering Iron	12	1M ohm ±10%	±150ppm/°C
PV37□205C31	0.25W(85°C)	Flow/Soldering Iron	12	2M ohm ±10%	±150ppm/°C

Operating Temperature Range: -55 to 125 °C

The blank column is filled with the code of adjustment direction and lead type (P, X, Y, W and Z).

The order quantity should be an integral multiple of the "Minimum Quantity".

The last three digits express the individual specification codes. C01 for standard type and C31 for radial taping type (PV37Y/PV37Z series only).

Part Number	Power Rating (W)	Soldering Method	Number of Turns (Effective Rotation Angle)	Total Resistance Value	TCR (ppm/°C)	Remarks
PV37□100A01	0.25(85°C)	Flow/Soldering Iron	12	10 ohm±10%	±100	Non Standard Product (Cd included)
PV37□200A01	0.25(85°C)	Flow/Soldering Iron	12	20 ohm±10%	±100	
PV37□500A01	0.25(85°C)	Flow/Soldering Iron	12	50 ohm±10%	±100	
PV37□101A01	0.25(85°C)	Flow/Soldering Iron	12	100 ohm±10%	±100	
PV37□201A01	0.25(85°C)	Flow/Soldering Iron	12	200 ohm±10%	±100	
PV37□501A01	0.25(85°C)	Flow/Soldering Iron	12	500 ohm±10%	±100	
PV37□102A01	0.25(85°C)	Flow/Soldering Iron	12	1k ohm±10%	±100	
PV37□202A01	0.25(85°C)	Flow/Soldering Iron	12	2k ohm±10%	±100	
PV37□502A01	0.25(85°C)	Flow/Soldering Iron	12	5k ohm±10%	±100	
PV37□103A01	0.25(85°C)	Flow/Soldering Iron	12	10k ohm±10%	±100	
PV37□203A01	0.25(85°C)	Flow/Soldering Iron	12	20k ohm±10%	±100	
PV37□253A01	0.25(85°C)	Flow/Soldering Iron	12	25k ohm±10%	±100	
PV37□503A01	0.25(85°C)	Flow/Soldering Iron	12	50k ohm±10%	±100	
PV37□104A01	0.25(85°C)	Flow/Soldering Iron	12	100k ohm±10%	±100	
PV37□204A01	0.25(85°C)	Flow/Soldering Iron	12	200k ohm±10%	±100	
PV37□254A01	0.25(85°C)	Flow/Soldering Iron	12	250k ohm±10%	±100	
PV37□504A01	0.25(85°C)	Flow/Soldering Iron	12	500k ohm±10%	±100	
PV37□105A01	0.25(85°C)	Flow/Soldering Iron	12	1M ohm±10%	±100	
PV37□205A01	0.25(85°C)	Flow/Soldering Iron	12	2M ohm±10%	±100	
PV37□100A31	0.25(85°C)	Flow/Soldering Iron	12	10 ohm±10%	±100	
PV37□200A31	0.25(85°C)	Flow/Soldering Iron	12	20 ohm±10%	±100	
PV37□500A31	0.25(85°C)	Flow/Soldering Iron	12	50 ohm±10%	±100	
PV37□101A31	0.25(85°C)	Flow/Soldering Iron	12	100 ohm±10%	±100	
PV37□201A31	0.25(85°C)	Flow/Soldering Iron	12	200 ohm±10%	±100	
PV37□501A31	0.25(85°C)	Flow/Soldering Iron	12	500 ohm±10%	±100	
PV37□102A31	0.25(85°C)	Flow/Soldering Iron	12	1k ohm±10%	±100	
PV37□202A31	0.25(85°C)	Flow/Soldering Iron	12	2k ohm±10%	±100	
PV37□502A31	0.25(85°C)	Flow/Soldering Iron	12	5k ohm±10%	±100	
PV37□103A31	0.25(85°C)	Flow/Soldering Iron	12	10k ohm±10%	±100	
PV37□203A31	0.25(85°C)	Flow/Soldering Iron	12	20k ohm±10%	±100	
PV37□253A31	0.25(85°C)	Flow/Soldering Iron	12	25k ohm±10%	±100	
PV37□503A31	0.25(85°C)	Flow/Soldering Iron	12	50k ohm±10%	±100	
PV37□104A31	0.25(85°C)	Flow/Soldering Iron	12	100k ohm±10%	±100	
PV37□204A31	0.25(85°C)	Flow/Soldering Iron	12	200k ohm±10%	±100	
PV37□254A31	0.25(85°C)	Flow/Soldering Iron	12	250k ohm±10%	±100	
PV37□504A31	0.25(85°C)	Flow/Soldering Iron	12	500k ohm±10%	±100	
PV37□105A31	0.25(85°C)	Flow/Soldering Iron	12	1M ohm±10%	±100	
PV37□205A31	0.25(85°C)	Flow/Soldering Iron	12	2M ohm±10%	±100	

■ Construction

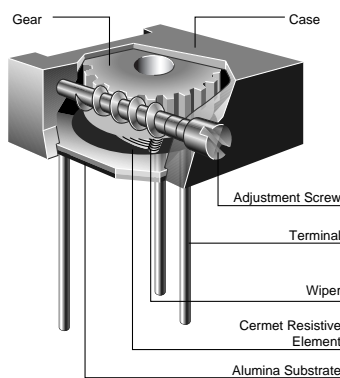

■ Mounting Holes

PV37P



(Tolerance:±0.1
in mm)

PV37W/PV37X



(Tolerance ±0.1
in mm)

PV37Y/PV37Z



(Tolerance:±0.1
in mm)

■ Characteristics

Temperature Cycle	ΔTR	±1%
	$\Delta V.S.S.$	±1%
Humidity	ΔTR	±2%
	IR	100Mohm min.
Vibration (20G)	ΔTR	±1%
	$\Delta V.S.S.$	±1%
Shock (100G)	ΔTR	±1%
	$\Delta V.S.S.$	±1%
Temperature Load Life	ΔTR	±2%
	$\Delta V.S.S.$	±1%
Low Temperature Exposure	ΔTR	±1%
	$\Delta V.S.S.$	±1%
High Temperature Exposure	ΔTR	±2%
	$\Delta V.S.S.$	±1%
Rotational Life (200 cycles)	ΔTR	R≤100ohm ... ±3%
		R>100ohm ... ±2%

ΔTR : Total Resistance Change
 $\Delta V.S.S.$: Voltage Setting Stability
 IR : Insulation Resistance
 R : Standard Total Resistance

PV23 Series

■ Features

1. Small size (4.6x6.4x19.1mm) and high power rating (0.75W at 70deg.C)
2. Sealed construction protects the interior from dust and liquid, which achieves stable performance.
3. Available for ultrasonic cleaning after soldering
4. Clutch mechanism prevents excessive wiper rotation.
5. To be complied with RoHS directive by new Cd free cermet resistive material. Pb free terminals with Sn plating.

■ Applications

1. Measuring instruments
2. FAX
3. Copier
4. Printers
5. Sensors



PV23P



PV23Y



Part Number	Power Rating	Soldering Method	Number of Turns (Effective Rotation Angle)	Total Resistance Value	TCR
PV23□100C01	0.75W(70°C)	Flow/Soldering Iron	15	10ohm ±10%	±150ppm/°C
PV23□200C01	0.75W(70°C)	Flow/Soldering Iron	15	20ohm ±10%	±150ppm/°C
PV23□500C01	0.75W(70°C)	Flow/Soldering Iron	15	50ohm ±10%	±150ppm/°C
PV23□101C01	0.75W(70°C)	Flow/Soldering Iron	15	100ohm ±10%	±150ppm/°C
PV23□201C01	0.75W(70°C)	Flow/Soldering Iron	15	200ohm ±10%	±100ppm/°C
PV23□501C01	0.75W(70°C)	Flow/Soldering Iron	15	500ohm ±10%	±100ppm/°C
PV23□102C01	0.75W(70°C)	Flow/Soldering Iron	15	1k ohm ±10%	±100ppm/°C
PV23□202C01	0.75W(70°C)	Flow/Soldering Iron	15	2k ohm ±10%	±100ppm/°C
PV23□502C01	0.75W(70°C)	Flow/Soldering Iron	15	5k ohm ±10%	±100ppm/°C
PV23□103C01	0.75W(70°C)	Flow/Soldering Iron	15	10k ohm ±10%	±100ppm/°C
PV23□203C01	0.75W(70°C)	Flow/Soldering Iron	15	20k ohm ±10%	±100ppm/°C
PV23□503C01	0.75W(70°C)	Flow/Soldering Iron	15	50k ohm ±10%	±100ppm/°C
PV23□104C01	0.75W(70°C)	Flow/Soldering Iron	15	100k ohm ±10%	±100ppm/°C
PV23□204C01	0.75W(70°C)	Flow/Soldering Iron	15	200k ohm ±10%	±100ppm/°C
PV23□504C01	0.75W(70°C)	Flow/Soldering Iron	15	500k ohm ±10%	±100ppm/°C
PV23□105C01	0.75W(70°C)	Flow/Soldering Iron	15	1M ohm ±10%	±100ppm/°C
PV23□205C01	0.75W(70°C)	Flow/Soldering Iron	15	2M ohm ±10%	±100ppm/°C

Operating Temperature Range: -55 to 125 °C

The blank column is filled with the code of adjustment direction and lead type (P and Y).

The order quantity should be an integral multiple of the "Minimum Quantity".

Part Number	Power Rating (W)	Soldering Method	Number of Turns (Effective Rotation Angle)	Total Resistance Value	TCR (ppm/°C)	Remarks
PV23□100A01	0.75(70°C)	Flow/Soldering Iron	15	10 ohm±10%	±100	Non Standard Product (Cd included)
PV23□200A01	0.75(70°C)	Flow/Soldering Iron	15	20 ohm±10%	±100	
PV23□500A01	0.75(70°C)	Flow/Soldering Iron	15	50 ohm±10%	±100	
PV23□101A01	0.75(70°C)	Flow/Soldering Iron	15	100 ohm±10%	±100	
PV23□201A01	0.75(70°C)	Flow/Soldering Iron	15	200 ohm±10%	±100	
PV23□501A01	0.75(70°C)	Flow/Soldering Iron	15	500 ohm±10%	±100	
PV23□102A01	0.75(70°C)	Flow/Soldering Iron	15	1k ohm±10%	±100	
PV23□202A01	0.75(70°C)	Flow/Soldering Iron	15	2k ohm±10%	±100	
PV23□502A01	0.75(70°C)	Flow/Soldering Iron	15	5k ohm±10%	±100	
PV23□103A01	0.75(70°C)	Flow/Soldering Iron	15	10k ohm±10%	±100	
PV23□203A01	0.75(70°C)	Flow/Soldering Iron	15	20k ohm±10%	±100	
PV23□503A01	0.75(70°C)	Flow/Soldering Iron	15	50k ohm±10%	±100	
PV23□104A01	0.75(70°C)	Flow/Soldering Iron	15	100k ohm±10%	±100	
PV23□204A01	0.75(70°C)	Flow/Soldering Iron	15	200k ohm±10%	±100	
PV23□504A01	0.75(70°C)	Flow/Soldering Iron	15	500k ohm±10%	±100	
PV23□105A01	0.75(70°C)	Flow/Soldering Iron	15	1M ohm±10%	±100	
PV23□205A01	0.75(70°C)	Flow/Soldering Iron	15	2M ohm±10%	±100	

■ Construction



■ Mounting Holes

PV23P



(Tolerance:±0.1 in mm)

PV23Y



(Tolerance:±0.1 in mm)

■ Characteristics

Temperature Cycle	Δ TR	$\pm 2\%$
	Δ V.S.S.	$\pm 1\%$
Humidity	Δ TR	$\pm 2\%$
	IR	100Mohm min.
Vibration (20G)	Δ TR	$\pm 1\%$
	Δ V.S.S.	$\pm 1\%$
Shock (50G)	Δ TR	$\pm 1\%$
	Δ V.S.S.	$\pm 1\%$
Temperature Load Life	Δ TR	$\pm 3\%$
	Δ V.S.S.	$\pm 1\%$
Low Temperature Exposure	Δ TR	$\pm 1\%$
	Δ V.S.S.	$\pm 1\%$
High Temperature Exposure	Δ TR	$\pm 2\%$
	Δ V.S.S.	$\pm 1\%$
Rotational Life (200 cycles)	Δ TR	$\pm 3\%$

Δ TR : Total Resistance Change
 Δ V.S.S. : Voltage Setting Stability
 IR : Insulation Resistance

PV22 Series

■ Features

1. High power rating (1W at 70 deg.C)
2. Sealed construction protects the interior from dust and liquid, which achieves stable performance.
3. Available for ultrasonic cleaning after soldering
4. Clutch mechanism prevents excessive wiper rotation.
5. To be complied with RoHS directive by new Cd free cermet resistive material. Pb free terminals with Sn plating.

■ Applications

1. Measuring instruments
2. FAX
3. Copier
4. Printers
5. Sensors



PV22L

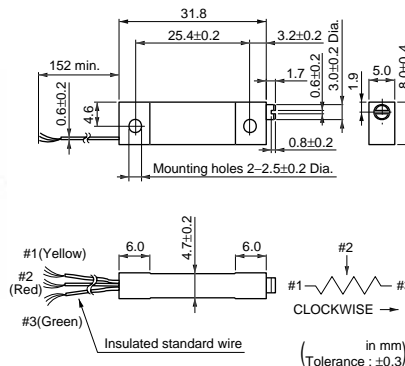

PV22S

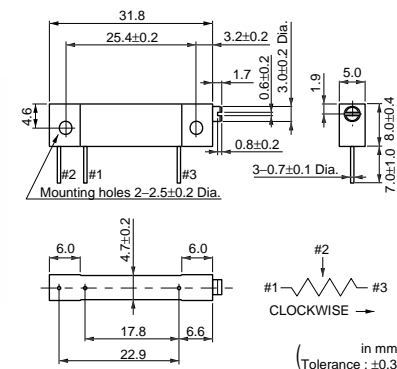

PV22Y

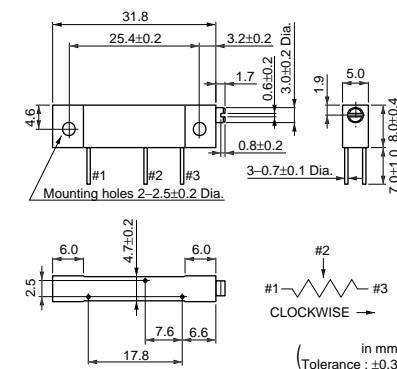

Part Number	Power Rating	Soldering Method	Number of Turns (Effective Rotation Angle)	Total Resistance Value	TCR
PV22□100C01	1.0W(70°C)	Flow/Soldering Iron	22	10ohm ±10%	±100ppm/°C
PV22□200C01	1.0W(70°C)	Flow/Soldering Iron	22	20ohm ±10%	±100ppm/°C
PV22□500C01	1.0W(70°C)	Flow/Soldering Iron	22	50ohm ±10%	±100ppm/°C
PV22□101C01	1.0W(70°C)	Flow/Soldering Iron	22	100ohm ±10%	±100ppm/°C
PV22□201C01	1.0W(70°C)	Flow/Soldering Iron	22	200ohm ±10%	±100ppm/°C
PV22□501C01	1.0W(70°C)	Flow/Soldering Iron	22	500ohm ±10%	±100ppm/°C
PV22□102C01	1.0W(70°C)	Flow/Soldering Iron	22	1k ohm ±10%	±100ppm/°C
PV22□202C01	1.0W(70°C)	Flow/Soldering Iron	22	2k ohm ±10%	±100ppm/°C
PV22□502C01	1.0W(70°C)	Flow/Soldering Iron	22	5k ohm ±10%	±100ppm/°C
PV22□103C01	1.0W(70°C)	Flow/Soldering Iron	22	10k ohm ±10%	±100ppm/°C
PV22□203C01	1.0W(70°C)	Flow/Soldering Iron	22	20k ohm ±10%	±100ppm/°C
PV22□503C01	1.0W(70°C)	Flow/Soldering Iron	22	50k ohm ±10%	±100ppm/°C
PV22□104C01	1.0W(70°C)	Flow/Soldering Iron	22	100k ohm ±10%	±100ppm/°C
PV22□204C01	1.0W(70°C)	Flow/Soldering Iron	22	200k ohm ±10%	±100ppm/°C
PV22□504C01	1.0W(70°C)	Flow/Soldering Iron	22	500k ohm ±10%	±100ppm/°C
PV22□105C01	1.0W(70°C)	Flow/Soldering Iron	22	1M ohm ±10%	±100ppm/°C

Continued on the following page. ↗

Continued from the preceding page.

Part Number	Power Rating	Soldering Method	Number of Turns (Effective Rotation Angle)	Total Resistance Value	TCR
PV22□205C01	1.0W(70°C)	Flow/Soldering Iron	22	2M ohm ±10%	±100ppm/°C

Operating Temperature Range: -55 to 150 °C

The blank column is filled with the code of adjustment direction and lead type (L, S and Y).

The order quantity should be an integral multiple of the "Minimum Quantity".

Part Number	Power Rating (W)	Soldering Method	Number of Turns (Effective Rotation Angle)	Total Resistance Value	TCR (ppm/°C)	Remarks
PV22□100A01	1.0(70°C)	Flow/Soldering Iron	22	10 ohm±10%	±100	Non Standard Product (Cd included)
PV22□200A01	1.0(70°C)	Flow/Soldering Iron	22	20 ohm±10%	±100	
PV22□500A01	1.0(70°C)	Flow/Soldering Iron	22	50 ohm±10%	±100	
PV22□101A01	1.0(70°C)	Flow/Soldering Iron	22	100 ohm±10%	±100	
PV22□201A01	1.0(70°C)	Flow/Soldering Iron	22	200 ohm±10%	±100	
PV22□501A01	1.0(70°C)	Flow/Soldering Iron	22	500 ohm±10%	±100	
PV22□102A01	1.0(70°C)	Flow/Soldering Iron	22	1k ohm±10%	±100	
PV22□202A01	1.0(70°C)	Flow/Soldering Iron	22	2k ohm±10%	±100	
PV22□502A01	1.0(70°C)	Flow/Soldering Iron	22	5k ohm±10%	±100	
PV22□103A01	1.0(70°C)	Flow/Soldering Iron	22	10k ohm±10%	±100	
PV22□203A01	1.0(70°C)	Flow/Soldering Iron	22	20k ohm±10%	±100	
PV22□503A01	1.0(70°C)	Flow/Soldering Iron	22	50k ohm±10%	±100	
PV22□104A01	1.0(70°C)	Flow/Soldering Iron	22	100k ohm±10%	±100	
PV22□204A01	1.0(70°C)	Flow/Soldering Iron	22	200k ohm±10%	±100	
PV22□504A01	1.0(70°C)	Flow/Soldering Iron	22	500k ohm±10%	±100	
PV22□105A01	1.0(70°C)	Flow/Soldering Iron	22	1M ohm±10%	±100	
PV22□205A01	1.0(70°C)	Flow/Soldering Iron	22	2M ohm±10%	±100	

■ Construction



■ Mounting Holes

PV22S



(Tolerance:±0.1 in mm)

PV22Y



(Tolerance:±0.1 in mm)

Continued on the following page. ↗

↳ Continued from the preceding page.

■ Characteristics

Temperature Cycle	Δ TR	$\pm 2\%$
	Δ V.S.S.	$\pm 1\%$
Humidity	Δ TR	$\pm 2\%$
	IR	100Mohm min.
Vibration (20G)	Δ TR	$\pm 1\%$
	Δ V.S.S.	$\pm 1\%$
Shock (50G)	Δ TR	$\pm 1\%$
	Δ V.S.S.	$\pm 1\%$
Temperature Load Life	Δ TR	$\pm 3\%$
	Δ V.S.S.	$\pm 1\%$
Low Temperature Exposure	Δ TR	$\pm 1\%$
	Δ V.S.S.	$\pm 1\%$
High Temperature Exposure	Δ TR	$\pm 2\%$
	Δ V.S.S.	$\pm 1\%$
Rotational Life (200 cycles)	Δ TR	$\pm 2\%$

Δ TR : Total Resistance Change
 Δ V.S.S. : Voltage Setting Stability
 IR : Insulation Resistance

PV36 Series

■ Features

1. High resolution 25-turns enables precision adjustment easily.
2. Sealed construction protects the interior from dust and liquid, which achieves stable performance.
3. Available for ultrasonic cleaning after soldering
4. Clutch mechanism prevents excessive wiper rotation.
5. 5 standard terminal styles
6. Both Top and side adjustment directions.
7. To be complied with RoHS directive by new Cd free cermet resistive material. Pb free terminals with Sn plating.

■ Applications

1. Measuring instruments
2. OA equipment
3. Medical equipment
4. Power supply
5. Base station for cellular phone



PV36P



PV36W



PV36X

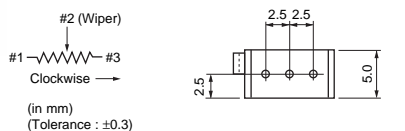
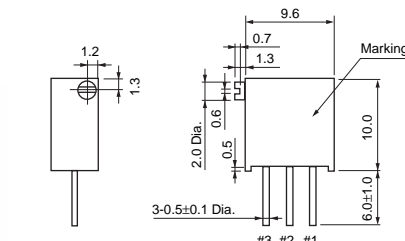

PV36Y



PV36Z



Part Number	Power Rating	Soldering Method	Number of Turns (Effective Rotation Angle)	Total Resistance Value	TCR
PV36□100C01	0.5W(70°C)	Flow/Soldering Iron	25	10ohm ±10%	±150ppm/°C
PV36□200C01	0.5W(70°C)	Flow/Soldering Iron	25	20ohm ±10%	±150ppm/°C
PV36□500C01	0.5W(70°C)	Flow/Soldering Iron	25	50ohm ±10%	±150ppm/°C

Continued on the following page.

Continued from the preceding page.

Part Number	Power Rating	Soldering Method	Number of Turns (Effective Rotation Angle)	Total Resistance Value	TCR
PV36□101C01	0.5W(70°C)	Flow/Soldering Iron	25	100ohm ±10%	±150ppm/°C
PV36□201C01	0.5W(70°C)	Flow/Soldering Iron	25	200ohm ±10%	±100ppm/°C
PV36□501C01	0.5W(70°C)	Flow/Soldering Iron	25	500ohm ±10%	±100ppm/°C
PV36□102C01	0.5W(70°C)	Flow/Soldering Iron	25	1k ohm ±10%	±100ppm/°C
PV36□202C01	0.5W(70°C)	Flow/Soldering Iron	25	2k ohm ±10%	±100ppm/°C
PV36□502C01	0.5W(70°C)	Flow/Soldering Iron	25	5k ohm ±10%	±100ppm/°C
PV36□103C01	0.5W(70°C)	Flow/Soldering Iron	25	10k ohm ±10%	±100ppm/°C
PV36□203C01	0.5W(70°C)	Flow/Soldering Iron	25	20k ohm ±10%	±100ppm/°C
PV36□253C01	0.5W(70°C)	Flow/Soldering Iron	25	25k ohm ±10%	±100ppm/°C
PV36□503C01	0.5W(70°C)	Flow/Soldering Iron	25	50k ohm ±10%	±100ppm/°C
PV36□104C01	0.5W(70°C)	Flow/Soldering Iron	25	100k ohm ±10%	±100ppm/°C
PV36□204C01	0.5W(70°C)	Flow/Soldering Iron	25	200k ohm ±10%	±100ppm/°C
PV36□254C01	0.5W(70°C)	Flow/Soldering Iron	25	250k ohm ±10%	±100ppm/°C
PV36□504C01	0.5W(70°C)	Flow/Soldering Iron	25	500k ohm ±10%	±100ppm/°C
PV36□105C01	0.5W(70°C)	Flow/Soldering Iron	25	1M ohm ±10%	±100ppm/°C
PV36□205C01	0.5W(70°C)	Flow/Soldering Iron	25	2M ohm ±10%	±100ppm/°C
PV36□100C31	0.5W(70°C)	Flow/Soldering Iron	25	10ohm ±10%	±150ppm/°C
PV36□200C31	0.5W(70°C)	Flow/Soldering Iron	25	20ohm ±10%	±150ppm/°C
PV36□500C31	0.5W(70°C)	Flow/Soldering Iron	25	50ohm ±10%	±150ppm/°C
PV36□101C31	0.5W(70°C)	Flow/Soldering Iron	25	100ohm ±10%	±150ppm/°C
PV36□201C31	0.5W(70°C)	Flow/Soldering Iron	25	200ohm ±10%	±100ppm/°C
PV36□501C31	0.5W(70°C)	Flow/Soldering Iron	25	500ohm ±10%	±100ppm/°C
PV36□102C31	0.5W(70°C)	Flow/Soldering Iron	25	1k ohm ±10%	±100ppm/°C
PV36□202C31	0.5W(70°C)	Flow/Soldering Iron	25	2k ohm ±10%	±100ppm/°C
PV36□502C31	0.5W(70°C)	Flow/Soldering Iron	25	5k ohm ±10%	±100ppm/°C
PV36□103C31	0.5W(70°C)	Flow/Soldering Iron	25	10k ohm ±10%	±100ppm/°C
PV36□203C31	0.5W(70°C)	Flow/Soldering Iron	25	20k ohm ±10%	±100ppm/°C
PV36□253C31	0.5W(70°C)	Flow/Soldering Iron	25	25k ohm ±10%	±100ppm/°C
PV36□503C31	0.5W(70°C)	Flow/Soldering Iron	25	50k ohm ±10%	±100ppm/°C
PV36□104C31	0.5W(70°C)	Flow/Soldering Iron	25	100k ohm ±10%	±100ppm/°C
PV36□204C31	0.5W(70°C)	Flow/Soldering Iron	25	200k ohm ±10%	±100ppm/°C
PV36□254C31	0.5W(70°C)	Flow/Soldering Iron	25	250k ohm ±10%	±100ppm/°C
PV36□504C31	0.5W(70°C)	Flow/Soldering Iron	25	500k ohm ±10%	±100ppm/°C
PV36□105C31	0.5W(70°C)	Flow/Soldering Iron	25	1M ohm ±10%	±100ppm/°C
PV36□205C31	0.5W(70°C)	Flow/Soldering Iron	25	2M ohm ±10%	±100ppm/°C

Operating Temperature Range: -55 to 125 °C

The blank column is filled with the code of adjustment direction and lead type (P, X, Y, W and Z).

The order quantity should be an integral multiple of the "Minimum Quantity".

The last three digits express the individual specification codes. C01 for standard type and C31 for radial taping type (PV36W/PV36X series only).

Part Number	Power Rating (W)	Soldering Method	Number of Turns (Effective Rotation Angle)	Total Resistance Value	TCR (ppm/°C)	Remarks
PV36□100A01	0.5(70°C)	Flow/Soldering Iron	25	10 ohm±10%	±100	Non Standard Product (Cd included)
PV36□200A01	0.5(70°C)	Flow/Soldering Iron	25	20 ohm±10%	±100	
PV36□500A01	0.5(70°C)	Flow/Soldering Iron	25	50 ohm±10%	±100	
PV36□101A01	0.5(70°C)	Flow/Soldering Iron	25	100 ohm±10%	±100	
PV36□201A01	0.5(70°C)	Flow/Soldering Iron	25	200 ohm±10%	±100	
PV36□501A01	0.5(70°C)	Flow/Soldering Iron	25	500 ohm±10%	±100	
PV36□102A01	0.5(70°C)	Flow/Soldering Iron	25	1k ohm±10%	±100	
PV36□202A01	0.5(70°C)	Flow/Soldering Iron	25	2k ohm±10%	±100	
PV36□502A01	0.5(70°C)	Flow/Soldering Iron	25	5k ohm±10%	±100	
PV36□103A01	0.5(70°C)	Flow/Soldering Iron	25	10k ohm±10%	±100	
PV36□203A01	0.5(70°C)	Flow/Soldering Iron	25	20k ohm±10%	±100	
PV36□253A01	0.5(70°C)	Flow/Soldering Iron	25	25k ohm±10%	±100	
PV36□503A01	0.5(70°C)	Flow/Soldering Iron	25	50k ohm±10%	±100	
PV36□104A01	0.5(70°C)	Flow/Soldering Iron	25	100k ohm±10%	±100	
PV36□204A01	0.5(70°C)	Flow/Soldering Iron	25	200k ohm±10%	±100	
PV36□254A01	0.5(70°C)	Flow/Soldering Iron	25	250k ohm±10%	±100	
PV36□504A01	0.5(70°C)	Flow/Soldering Iron	25	500k ohm±10%	±100	
PV36□105A01	0.5(70°C)	Flow/Soldering Iron	25	1M ohm±10%	±100	
PV36□205A01	0.5(70°C)	Flow/Soldering Iron	25	2M ohm±10%	±100	
PV36□100A31	0.5(70°C)	Flow/Soldering Iron	25	10 ohm±10%	±100	
PV36□200A31	0.5(70°C)	Flow/Soldering Iron	25	20 ohm±10%	±100	
PV36□500A31	0.5(70°C)	Flow/Soldering Iron	25	50 ohm±10%	±100	
PV36□101A31	0.5(70°C)	Flow/Soldering Iron	25	100 ohm±10%	±100	
PV36□201A31	0.5(70°C)	Flow/Soldering Iron	25	200 ohm±10%	±100	
PV36□501A31	0.5(70°C)	Flow/Soldering Iron	25	500 ohm±10%	±100	
PV36□102A31	0.5(70°C)	Flow/Soldering Iron	25	1k ohm±10%	±100	
PV36□202A31	0.5(70°C)	Flow/Soldering Iron	25	2k ohm±10%	±100	
PV36□502A31	0.5(70°C)	Flow/Soldering Iron	25	5k ohm±10%	±100	
PV36□103A31	0.5(70°C)	Flow/Soldering Iron	25	10k ohm±10%	±100	
PV36□203A31	0.5(70°C)	Flow/Soldering Iron	25	20k ohm±10%	±100	
PV36□253A31	0.5(70°C)	Flow/Soldering Iron	25	25k ohm±10%	±100	
PV36□503A31	0.5(70°C)	Flow/Soldering Iron	25	50k ohm±10%	±100	
PV36□104A31	0.5(70°C)	Flow/Soldering Iron	25	100k ohm±10%	±100	
PV36□204A31	0.5(70°C)	Flow/Soldering Iron	25	200k ohm±10%	±100	
PV36□254A31	0.5(70°C)	Flow/Soldering Iron	25	250k ohm±10%	±100	
PV36□504A31	0.5(70°C)	Flow/Soldering Iron	25	500k ohm±10%	±100	
PV36□105A31	0.5(70°C)	Flow/Soldering Iron	25	1M ohm±10%	±100	
PV36□205A31	0.5(70°C)	Flow/Soldering Iron	25	2M ohm±10%	±100	

■ Construction



■ Mounting Holes

PV36P



(Tolerance:±0.1
in mm)

PV36W/X



(Tolerance:±0.1
in mm)

PV36Y/Z

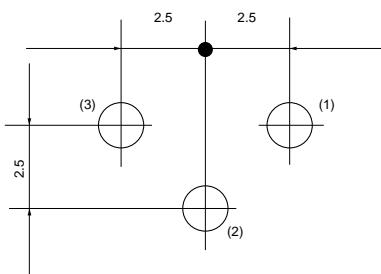

(Tolerance:±0.1
in mm)

■ Characteristics

Temperature Cycle	ΔTR	±2%
	$\Delta V.S.S.$	±1%
Humidity	ΔTR	±2%
	IR	100Mohm min.
Vibration (20G)	ΔTR	±1%
	$\Delta V.S.S.$	±1%
Shock (100G)	ΔTR	±1%
	$\Delta V.S.S.$	±1%
Temperature Load Life	ΔTR	±3%
	$\Delta V.S.S.$	±1%
Low Temperature Exposure	ΔTR	±2%
	$\Delta V.S.S.$	±1%
High Temperature Exposure	ΔTR	±3%
	$\Delta V.S.S.$	±1%
Rotational Life (200 cycles)	ΔTR	$R \leq 1\text{kohm}, R \geq 500\text{kohm} \dots \pm 5\%$ $1\text{kohm} < R < 500\text{kohm} \dots \pm 3\%$

ΔTR : Total Resistance Change
 $\Delta V.S.S.$: Voltage Setting Stability
 IR : Insulation Resistance
 R : Standard Total Resistance

PV12/PV37/PV23/PV22/PV36 Series Notice

■ Notice (Operating and Storage Conditions)

1. Store in temperatures of -10 to +40 deg. C and relative humidity of 30-85%RH.
2. Do not store in or near corrosive gases.
3. Use within six months after delivery.
4. Open the package just before using.
5. Do not store under direct sunlight.
6. If you use the trimmer potentiometer in an environment other than listed below, please consult with a Murata factory representative prior to using.
The trimmer potentiometer should not be used under

- the following environmental conditions:
- (1) Corrosive gaseous atmosphere
(Ex. Chlorine gas, Hydrogen sulfide gas, Ammonia gas, Sulfuric acid gas, Nitric oxide gas, etc.)
 - (2) In liquid
(Ex. Oil, Medical liquid, Organic solvent, etc.)
 - (3) Dusty / dirty atmosphere
 - (4) Direct sunlight
 - (5) Static voltage nor electric/magnetic fields
 - (6) Direct sea breeze
 - (7) Other variations of the above

■ Notice (Rating)

1. When using with partial load (rheostat), minimize the power depending on the resistance value.
2. The maximum input voltage to a trimmer potentiometer should not exceed $(P.R)^{1/2}$ or the maximum operating voltage, whichever is smaller.
3. The maximum input current to a trimmer potentiometer should not exceed $(P/R)^{1/2}$ or the allowable wiper current, whichever is smaller.

■ Notice (Soldering and Mounting)

1. Soldering
 - (1) Standard soldering condition
 - (a) Flow soldering :
 - >Pre-heating temp. 80-100 deg. C
 - >Soldering temp. 260 deg. C max.
 - >Soldering time 3 sec. max.
 - (b) Soldering iron :
 - >Temperature of tip 300 deg. C max.
 - >Soldering time 3 sec. max.
 - >Wattage of iron 40W max.

Before using other soldering conditions than those listed above, please consult with Murata factory representative prior to using. If the soldering conditions are not suitable, e.g., excessive time and/or excessive temperature, the trimmer potentiometer may deviate from the specified characteristics.

 - (2) To minimize mechanical stress when adjusting, the trimmer potentiometer should be mounted onto PCB without gap.
 - (3) The soldering iron should not come in contact with the case of the trimmer potentiometer. If such contact does occur, the trimmer potentiometer may be damaged.
2. Mounting
 - (1) Use PCB hole to meet the pin of the trimmer potentiometer. If the trimmer potentiometer installs into insufficient PCB hole, the

- trimmer potentiometer may be damaged by mechanical stress.
- (2) Do not apply excessive force (preferably 9.8N (Ref.: 1kgf) max.), when the trimmer potentiometer is mounted to the PCB.
3. Cleaning
 - (1) Isopropyl-alcohol and Ethyl-alcohol are applicable solvents for cleaning. If you use any other types of solvents, please consult with a Murata factory representative prior to using.
 - (2) The total cleaning time by cold dipping, vapor and ultrasonic washing (conditions as below) method should be less than 3 minutes.
 - (3) For ultra-sonic cleaning, the available condition is as follows.
 - >Power: 600W (67 liter) max.
 - >Frequency: 28kHz
 - >Temperature: Ambient temperature

Due to the ultra-sonic cleaning equipment's peculiar self-resonance point and that the cleaning compatibility usually depends on the jig construction and/or the cleaning condition such as the depth of immersion, please check the cleaning equipment to determine the suitable conditions.

If the trimmer potentiometer is cleaned by other conditions, the trimmer potentiometer may be damaged.

PV12/PV37/PV23/PV22/PV36 Series Notice

■ Notice (Handling)

1. Use suitable screwdrivers that fit comfortably in driver slot. We recommend the screwdrivers below.

* Recommended screwdriver for manual adjustment
ENGINEER INC. : DA-40

(Murata P/N : KMDR180)

We can supply the screwdrivers above.

If you place order, please specify the Murata P/N.

2. Don't apply more than 9.8N (Ref.; 1kgf) of twist and stress after mounting onto PCB to prevent contact intermittence. If excessive force is

applied, the trimmer potentiometer may not function.

3. When adjusting with an adjustment tool, the applied force to the adjustment screw should not exceed 4.9N (Ref.; 500gf). If excessive force is applied, the trimmer potentiometer may not function due to damage.

4. When using a lock paint to fix slot position, please use adhesive resin without chlorine or sulfur (Three-bond "1401 series").

■ Notice (Other)

1. Please make sure that your product has been evaluated and confirmed against your specifications when our product is mounted to your product.

2. Murata cannot guarantee trimmer potentiometer integrity when used under conditions other than those specified in this document.

SMD Sealed Type/Lead Sealed Type Specifications and Test Methods

The following describes trimmer potentiometer testing conducted by Murata Manufacturing Co., Ltd. in accordance with MIL-R-22097 (Military specification for variable resistors, non-wirewound) and MIL-STD-202 (Test methods for electronic and electrical component parts).

No.	Item	Test Methods																				
1	Total Resistance	<p>Measure total resistance between the resistance element and terminals (#1 and #3) with the contact arm positioned against a stop. The positioning of the contact arm and terminal should be the same for subsequent total resistance measurements on the same device. Use the test voltage specified in Table 1 for total resistance measurements. This voltage should be used for all subsequent total resistance measurements.</p> <table border="1" style="margin-left: auto; margin-right: auto; border-collapse: collapse;"> <thead> <tr style="background-color: #f2f2f2;"> <th>Total Resistance, Nominal (ohm)</th> <th>Maximum Test Voltage (V)</th> </tr> </thead> <tbody> <tr> <td>10 ≤ R ≤ 100</td> <td>1.0</td> </tr> <tr> <td>100 < R ≤ 1k</td> <td>3.0</td> </tr> <tr> <td>1k < R ≤ 10k</td> <td>10.0</td> </tr> <tr> <td>10k < R ≤ 100k</td> <td>30.0</td> </tr> <tr> <td>100k < R</td> <td>100.0</td> </tr> </tbody> </table> <p style="text-align: center;">Table 1: Total resistance test voltage</p>	Total Resistance, Nominal (ohm)	Maximum Test Voltage (V)	10 ≤ R ≤ 100	1.0	100 < R ≤ 1k	3.0	1k < R ≤ 10k	10.0	10k < R ≤ 100k	30.0	100k < R	100.0								
Total Resistance, Nominal (ohm)	Maximum Test Voltage (V)																					
10 ≤ R ≤ 100	1.0																					
100 < R ≤ 1k	3.0																					
1k < R ≤ 10k	10.0																					
10k < R ≤ 100k	30.0																					
100k < R	100.0																					
2	Residual Resistance	<p>Position the contact arm at the extreme counterclockwise limit of mechanical travel and measure the resistance between the contact arm and the corresponding end terminal. Then, position the contact arm at the extreme clockwise limit of mechanical travel and measure the resistance between the contact arm and the corresponding end terminal. During this test, take suitable precautions to ensure that the rated current of the resistance element is not exceeded.</p>																				
3	Contact Resistance Variation	<p>Contact resistance variation should be measured with the measuring circuit shown in Figure 1, or its equivalent. The adjustment rotor (screw) should be rotated in both directions through 90% of the actual effective-electrical rotational angle (number of turns) for a total of 6 cycles. Only the last 3 cycles should count in determining whether or not a contact resistance variation is observed at least twice in the same location, exclusive of the roll-on or roll-off points where the contact arm moves from the termination, on or off, the resistance element. The rate of rotation of the adjustment rotor (screw) should be such that the adjustment rotor (screw) completes 1 cycle for 5 seconds minimum to 2 minutes maximum. The test current used should follow the value given in Table 2 unless otherwise limited by power rating.</p> <table border="1" style="margin-left: auto; margin-right: auto; border-collapse: collapse;"> <thead> <tr style="background-color: #f2f2f2;"> <th>Standard Total Resistance R (ohm)</th> <th>Test Current</th> </tr> </thead> <tbody> <tr> <td>R ≤ 100</td> <td>20mA</td> </tr> <tr> <td>100 < R < 500</td> <td>10mA</td> </tr> <tr> <td>500 ≤ R < 1k</td> <td>4mA</td> </tr> <tr> <td>1k ≤ R < 2k</td> <td>2mA</td> </tr> <tr> <td>2k ≤ R < 50k</td> <td>1mA</td> </tr> <tr> <td>50k ≤ R < 200k</td> <td>200µA</td> </tr> <tr> <td>200k ≤ R < 1M</td> <td>100µA</td> </tr> <tr> <td>1M ≤ R < 2M</td> <td>50µA</td> </tr> <tr> <td>2M ≤ R</td> <td>30µA</td> </tr> </tbody> </table> <div style="text-align: right; margin-top: 10px;">  <p style="font-size: small;">Rx : Trimmer Potentiometer Oscilloscope bandwidth : 100Hz to 50kHz</p> <p style="text-align: center;">Figure 1: CRV measuring circuit</p> </div> <p style="text-align: center;">Table 2: Test current for CRV</p>	Standard Total Resistance R (ohm)	Test Current	R ≤ 100	20mA	100 < R < 500	10mA	500 ≤ R < 1k	4mA	1k ≤ R < 2k	2mA	2k ≤ R < 50k	1mA	50k ≤ R < 200k	200µA	200k ≤ R < 1M	100µA	1M ≤ R < 2M	50µA	2M ≤ R	30µA
Standard Total Resistance R (ohm)	Test Current																					
R ≤ 100	20mA																					
100 < R < 500	10mA																					
500 ≤ R < 1k	4mA																					
1k ≤ R < 2k	2mA																					
2k ≤ R < 50k	1mA																					
50k ≤ R < 200k	200µA																					
200k ≤ R < 1M	100µA																					
1M ≤ R < 2M	50µA																					
2M ≤ R	30µA																					
4	Temperature Coefficient of Resistance	<p>The trimmer potentiometer should be subjected to each of the following temperatures (see Table 3) for 30-45 minutes. Temperature coefficient of resistance should be applied to the following formula.</p> $TCR = \frac{R_2 - R_1}{R_1 (T_2 - T_1)} \times 10^6 \text{ (ppm/°C)}$ <p style="margin-left: 20px;"> T_1 : Reference temperature in degrees celsius T_2 : Test temperature in degrees celsius R_1 : Resistance at reference temperature ohm R_2 : Resistance at test temperature in ohm </p> <table border="1" style="margin-left: auto; margin-right: auto; border-collapse: collapse; text-align: center;"> <thead> <tr style="background-color: #f2f2f2;"> <th>Sequence</th> <th>1*</th> <th>2</th> <th>3</th> <th>4*</th> <th>5</th> <th>6</th> </tr> </thead> <tbody> <tr> <td>Temperature (°C)</td> <td>+25</td> <td>-15</td> <td>Min. operating Temperature</td> <td>+25</td> <td>+65</td> <td>Max. operating Temperature</td> </tr> </tbody> </table> <p style="font-size: x-small;">Note*: Reference temperature</p> <p style="text-align: center;">Table 3: Test temperatures</p>	Sequence	1*	2	3	4*	5	6	Temperature (°C)	+25	-15	Min. operating Temperature	+25	+65	Max. operating Temperature						
Sequence	1*	2	3	4*	5	6																
Temperature (°C)	+25	-15	Min. operating Temperature	+25	+65	Max. operating Temperature																
5	Voltage Setting Stability	<p>The wiper should be set at approximately 40% of the actual effective-electrical rotational angle (number of turns). An adequate DC test potential should be applied between terminal #1 and terminal #3. The voltage between terminal #1 and terminal #3, and the voltage between terminal #1 and terminal #2, should be measured and applied to the following formula.</p> $\text{Voltage setting stability} = \left(\frac{e'}{E} - \frac{e}{E} \right) \times 100 \text{ (\%)}$ <p style="margin-left: 20px;"> e : Before test (The voltage between terminal #1 and terminal #2) e' : After test (The voltage between terminal #1 and terminal #2) E : The voltage between terminal #1 and terminal #3 </p> <div style="text-align: right; margin-top: 10px;">  <p style="text-align: center;">Figure 2</p> </div>																				

Continued on the following page.

SMD Sealed Type/Lead Sealed Type Specifications and Test Methods

☐ Continued from the preceding page.

No.	Item	Test Methods																								
6	Temperature Cycle	<p>The trimmer potentiometer should be subjected to Table 4 temperature for 5 cycles. The trimmer potentiometer should be removed from the chamber, and maintained at a temperature of 25±5°C for 1–2 hours.</p> <table border="1" style="margin-left: auto; margin-right: auto; border-collapse: collapse;"> <thead> <tr> <th style="text-align: left;">Sequence</th> <th style="width: 10%;">1</th> <th style="width: 10%;">2</th> <th style="width: 10%;">3</th> <th style="width: 10%;">4</th> </tr> </thead> <tbody> <tr> <td rowspan="3" style="text-align: center;">Temp. (°C)</td> <td>PV□□ series</td> <td>-55±3</td> <td>+25±2</td> <td>+125±3</td> </tr> <tr> <td>PV22 series</td> <td></td> <td></td> <td>+25±2</td> </tr> <tr> <td>PVF2 series</td> <td>-25±3</td> <td></td> <td>+60±3</td> </tr> <tr> <td colspan="2" style="text-align: left;">Time (min.)</td> <td>30</td> <td>5 max.</td> <td>30</td> <td>5 max.</td> </tr> </tbody> </table> <p style="text-align: center;">Table 4: One cycle of temperature cycle.</p>	Sequence	1	2	3	4	Temp. (°C)	PV□□ series	-55±3	+25±2	+125±3	PV22 series			+25±2	PVF2 series	-25±3		+60±3	Time (min.)		30	5 max.	30	5 max.
Sequence	1	2	3	4																						
Temp. (°C)	PV□□ series	-55±3	+25±2	+125±3																						
	PV22 series			+25±2																						
	PVF2 series	-25±3		+60±3																						
Time (min.)		30	5 max.	30	5 max.																					
7	Humidity	<p>1) PVC6, PV12, PV32, PV34 PVM4A□□□D01 series The trimmer potentiometer should be placed in a chamber at a temperature of 40±2°C and a humidity of 90–95% without loading for 250±8 hours (500±12 hours for PVM4A□□□D01 series). The trimmer potentiometer should be removed from the chamber, and maintained at a temperature of 25±5°C for 5±1/6 hours.</p> <p>2) PVF2 series The trimmer potentiometer should be placed in a chamber at 60±2°C and 90–95% without loading for 1000±12 hours. The trimmer potentiometer should be removed from the chamber, and maintained at a temperature of 25±5°C for 5±1/6 hours</p> <p>2) PVG3, PVG5, PV01, PV22, PV23, PV36, PV37 series The trimmer potentiometer should be subjected Figure-3 the programmed humidity environment for 10 cycle. The trimmer potentiometer should be removed from the chamber, and maintained at a temperature of 25±5°C for 1.5±1/2 hours.</p> <div style="text-align: right; font-size: small; margin-bottom: 5px;">MIL-STD-202 METHOD 106</div> <p style="text-align: center;">Figure 3</p>																								
8	Vibration	<p>1) PV□□ series The trimmer potentiometer should be vibrated throughout the frequency range at the 20G level. A complete frequency range, 10Hz to 2000Hz and back, should be made within 15 minutes for a total of 4 sweeps in each of the three axis direction for a total of 12 sweeps.</p> <p>2) PVF2 series The trimmer potentiometer should be subjected to vibration at 0.3 inch amplitude. The frequency should be varied uniformly between the approximate limits of 10Hz and 55Hz. This motion should be applied for period of 2 hours in each of 3 mutually perpendicular directions (total of 6 hours).</p>																								
9	Shock	<p>1) PV□□ series The trimmer potentiometer should be shocked at the 100G (50G for PV22 and PV23 series) level and should be subjected to 4 shocks in each of the three axis directions for a total of 12 shocks.</p> <p>2) PVM4A□□□D01 series The trimmer potentiometer should be shocked at the 100G level and should be subjected to 3 shocks in each of the six axis directions for a total of 18 shocks.</p>																								
10	Temperature Road Life	Full rated continuous working voltage not exceeding the maximum rated voltage should be applied intermittently between terminal #1 and terminal #3 of the trimmer potentiometer, 1.5 hours on and 0.5 hours off, for a total of 1000±12 hours, at a temperature of 70±2°C (85±2°C for PV01 and PV37 series, 50±2°C for PVF2 series). The trimmer potentiometer should be removed from the chamber, and maintained at a temperature of 25±5°C for 1 to 2 hours.																								
11	High Temperature Exposure (Except for PVF2)	The trimmer potentiometer should be placed in a chamber at a temperature of 125±3°C (150±3°C for PV22 series) 250±8 hours without loading. The trimmer potentiometer should be removed from the chamber, and maintained at a temperature of 25±5°C for 1 to 2 hours.																								
12	Low Temperature Exposure (Except for PVF2 and PVM4A□□□D01)	The trimmer potentiometer should be placed in a chamber at a temperature of -55±3°C for 1 hours without loading. Full rated continuous working voltage not exceeding the maximum rated voltage should be applied for 45 minutes. The trimmer potentiometer should be removed from the chamber, and maintained at a temperature of 25±5°C for approximately 24 hours.																								

Continued on the following page. ☐

SMD Sealed Type/Lead Sealed Type Specifications and Test Methods

☐ Continued from the preceding page.

No.	Item	Test Methods
13	Low Temperature Operation (Only for PVF2 and PVM4A□□□D01)	The trimmer potentiometer should be placed in a chamber at a temperature of $-25\pm 3^{\circ}\text{C}$ ($-55\pm 3^{\circ}\text{C}$ for PVM4A□□□D01 series) 48 ± 4 hours without loading. The trimmer potentiometer should be removed from the chamber, and maintained at a temperature of $25\pm 5^{\circ}\text{C}$ for 1-2 hours
14	Rotational Life	<p>1) PV□□ series Full rated continuous working voltage not exceeding the maximum rated voltage should be applied with the circuit shown in the figure. The adjustment rotor (screw) should be continuously cycled through not less than 90% of effective-electrical rotational angle (number of turns), at the rate of 1 cycle for 5 seconds minimum to 2.5 minutes maximum for total of 200 cycles.</p> <div style="text-align: center;">  <p>Figure 4</p> </div> <p>2) PVG3, PVG5 series The adjustment rotor (screw) should be continuously cycled though not less than 90% of effective-electrical rotational angle (number of turns), at the rate of 1 cycle for 5 seconds minimum to 2.5 minutes maximum for a total of 50 (100 for PVG5) cycles, without loading.</p> <p>3) PVF2, PVM4A□□□D01 series The wiper should be rotated over 90% of the effective rotational angle without loading at a speed of 10 cycles per minute, for 100 cycles continuously.</p>



Стандарт Электрон Связь

Мы молодая и активно развивающаяся компания в области поставок электронных компонентов. Мы поставляем электронные компоненты отечественного и импортного производства напрямую от производителей и с крупнейших складов мира.

Благодаря сотрудничеству с мировыми поставщиками мы осуществляем комплексные и плановые поставки широчайшего спектра электронных компонентов.

Собственная эффективная логистика и склад в обеспечивает надежную поставку продукции в точно указанные сроки по всей России.

Мы осуществляем техническую поддержку нашим клиентам и предпродажную проверку качества продукции. На все поставляемые продукты мы предоставляем гарантию .

Осуществляем поставки продукции под контролем ВП МО РФ на предприятия военно-промышленного комплекса России , а также работаем в рамках 275 ФЗ с открытием отдельных счетов в уполномоченном банке. Система менеджмента качества компании соответствует требованиям ГОСТ ISO 9001.

Минимальные сроки поставки, гибкие цены, неограниченный ассортимент и индивидуальный подход к клиентам являются основой для выстраивания долгосрочного и эффективного сотрудничества с предприятиями радиоэлектронной промышленности, предприятиями ВПК и научно-исследовательскими институтами России.

С нами вы становитесь еще успешнее!

Наши контакты:

Телефон: +7 812 627 14 35

Электронная почта: sales@st-electron.ru

Адрес: 198099, Санкт-Петербург,
Промышленная ул, дом № 19, литера Н,
помещение 100-Н Офис 331