

Single 9-A High-Speed, Low-Side Gate Driver

FAN3121, FAN3122

Description

The FAN3121 and FAN3122 MOSFET drivers are designed to drive N-channel enhancement MOSFETs in low-side switching applications by providing high peak current pulses. The drivers are available with either TTL input thresholds (FAN312xT) or V_{DD} -proportional CMOS input thresholds (FAN312xC). Internal circuitry provides an under-voltage lockout function by holding the output low until the supply voltage is within the operating range.

FAN312x drivers incorporate the MillerDrive™ architecture for the final output stage. This bipolar / MOSFET combination provides the highest peak current during the Miller plateau stage of the MOSFET turn-on / turn-off process.

The FAN3121 and FAN3122 drivers implement an enable function on pin 3 (EN), previously unused in the industry-standard pin-out. The pin is internally pulled up to V_{DD} for active HIGH logic and can be left open for standard operation.

The commercial FAN3121/22 is available in a 3x3 mm 8-lead thermally-enhanced MLP package or an 8-lead SOIC package with the option for an exposed pad.

Features

- Industry-Standard Pin-out with Enable Input
- 4.5-V to 18-V Operating Range
- 11.4 A Peak Sink at $V_{DD} = 12$ V
- 9.7-A Sink / 7.1-A Source at $V_{OUT} = 6$ V
- Inverting Configuration (FAN3121) and Non-Inverting Configuration (FAN3122)
- Internal Resistors Turn Driver Off if No Inputs
- 23-ns / 19-ns Typical Rise/Fall Times (10 nF Load)
- 18 ns to 23 ns Typical Propagation Delay Time
- Choice of TTL or CMOS Input Thresholds
- MillerDrive Technology
- Available in Thermally Enhanced 3x3 mm 8-Lead MLP or 8-Lead SOIC Package (Pb-Free Finish)
- Rated from -40°C to $+125^{\circ}\text{C}$
- These are Pb-Free Devices

Applications

- Synchronous Rectifier Circuits
- High-Efficiency MOSFET Switching
- Switch-Mode Power Supplies
- DC-to-DC Converters
- Motor Control



ON Semiconductor®

www.onsemi.com



WDFN8 3x3, 0.65P
CASE 511CD



SOIC8
CASE 751EB

MARKING DIAGRAM

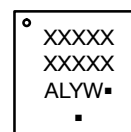

WDFN8

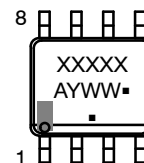

SOIC8

- A = Assembly Location
- L = Wafer Lot
- Y = Year
- W = Work Week
- = Pb-Free Package

(Note: Microdot may be in either location)

*This information is generic. Please refer to device data sheet for actual part marking. Pb-Free indicator, "G" or microdot "▪", may or may not be present.

ORDERING INFORMATION

See detailed ordering and shipping information on page 17 of this data sheet.

FAN3121, FAN3122

PIN CONFIGURATIONS

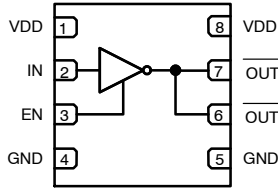

Figure 1. FAN3121 Pin Configuration

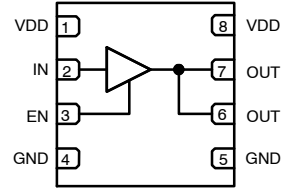

Figure 2. FAN3122 Pin Configuration

PACKAGE OUTLINES

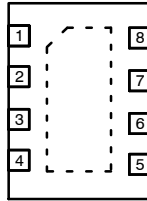

Figure 3. 3x3 mm MLP-8 (Top View)

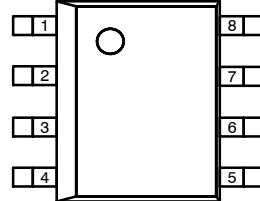

Figure 4. SOIC-8 (Top View)

THERMAL CHARACTERISTICS (Note 1)

Package	θ_{JL} (Note 2)	θ_{JT} (Note 3)	θ_{JA} (Note 4)	Ψ_{JB} (Note 5)	Ψ_{JT} (Note 6)	Unit
8-Lead 3x3 mm Molded Leadless Package (MLP)	1.2	64	42	2.8	0.7	°C/W
8-Pin Small Outline Integrated Circuit (SOIC)	38	29	87	41	2.3	°C/W

1. Estimates derived from thermal simulation; actual values depend on the application.
2. θ_{JL} (θ_{JL}): Thermal resistance between the semiconductor junction and the bottom surface of all the leads (including any thermal pad) that are typically soldered to a PCB.
3. θ_{JT} (θ_{JT}): Thermal resistance between the semiconductor junction and the top surface of the package, assuming it is held at a uniform temperature by a top-side heatsink.
4. θ_{JA} (θ_{JA}): Thermal resistance between junction and ambient, dependent on the PCB design, heat sinking, and airflow. The value given is for natural convection with no heatsink using a 2S2P board, as specified in JEDEC standards JESD51-2, JESD51-5, and JESD51-7, as appropriate.
5. Ψ_{JB} (Ψ_{JB}): Thermal characterization parameter providing correlation between semiconductor junction temperature and an application circuit board reference point for the thermal environment defined in Note 4. For the MLP-8 package, the board reference is defined as the PCB copper connected to the thermal pad and protruding from either end of the package. For the SOIC-8 package, the board reference is defined as the PCB copper adjacent to pin 6.
6. Ψ_{JT} (Ψ_{JT}): Thermal characterization parameter providing correlation between the semiconductor junction temperature and the center of the top of the package for the thermal environment defined in Note 4.

FAN3121, FAN3122

PIN DEFINITIONS

FAN3121	FAN3122	Name	Description
3	3	EN	<i>Enable Input.</i> Pull pin LOW to inhibit driver. EN has logic thresholds for both TTL and CMOS IN thresholds.
4, 5	4, 5	GND	<i>Ground.</i> Common ground reference for input and output circuits.
2	2	IN	<i>Input.</i>
	6, 7	OUT	<i>Gate Drive Output.</i> Held LOW unless required input is present and V_{DD} is above the UVLO threshold.
6, 7		$\overline{\text{OUT}}$	<i>Gate Drive Output (inverted from the input).</i> Held LOW unless required input is present and V_{DD} is above the UVLO threshold.
1, 8	1, 8	V_{DD}	<i>Supply Voltage.</i> Provides power to the IC.
		P1	<i>Thermal Pad (MLP only).</i> Exposed metal on the bottom of the package; it is recommended to connect externally on the PCB the Exposed Pad together with the Ground. NOT suitable for carrying current.

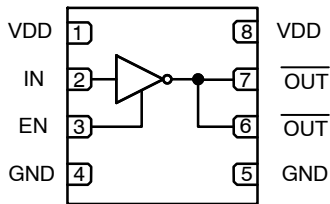

Figure 5. FAN3121 Pin Assignments (Repeated)

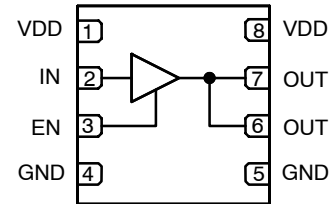

Figure 6. FAN3122 Pin Assignments (Repeated)

OUTPUT LOGIC

FAN3121		
EN	IN	OUT
0	0	0
0	1 (Note 7)	0
1 (Note 7)	0	1
1 (Note 7)	1 (Note 7)	0

FAN3122		
EN	IN	OUT
0	0 (Note 7)	0
0	1	0
1 (Note 7)	0 (Note 7)	0
1 (Note 7)	1	1

7. Default input signal if no external connection is made.

FAN3121, FAN3122

BLOCK DIAGRAM

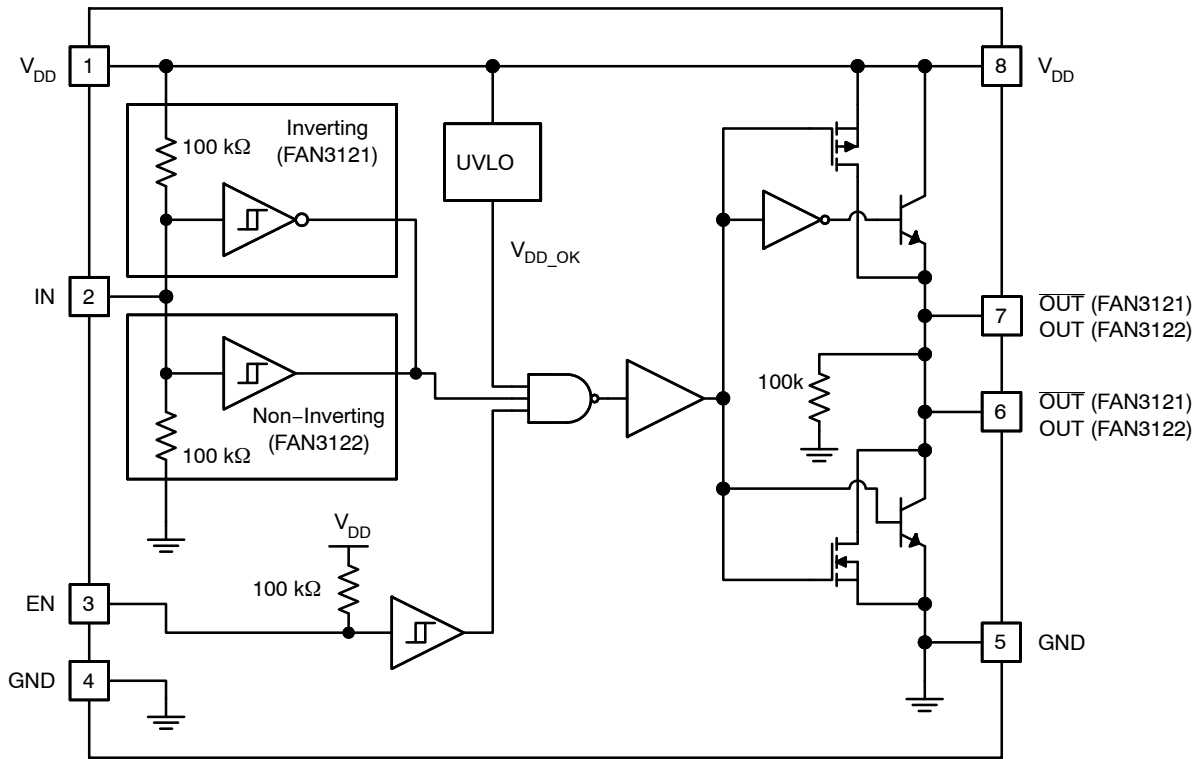

Figure 7. Block Diagram

ABSOLUTE MAXIMUM RATINGS

Symbol	Parameter	Min	Max	Unit
V_{DD}	V_{DD} to GND	-0.3	20.0	V
V_{EN}	EN to GND	GND - 0.3	$V_{DD} + 0.3$	V
V_{IN}	IN to GND	GND - 0.3	$V_{DD} + 0.3$	V
V_{OUT}	OUT to GND	GND - 0.3	$V_{DD} + 0.3$	V
T_L	Lead Soldering Temperature (10 Seconds)	-	+260	°C
T_J	Junction Temperature	-55	+150	°C
T_{STG}	Storage Temperature	-65	+150	°C

Stresses exceeding those listed in the Maximum Ratings table may damage the device. If any of these limits are exceeded, device functionality should not be assumed, damage may occur and reliability may be affected.

RECOMMENDED OPERATING CONDITIONS

Symbol	Parameter	Min	Max	Unit
V_{DD}	Supply Voltage Range	4.5	18.0	V
V_{EN}	Enable Voltage EN	0	V_{DD}	V
V_{IN}	Input Voltage IN	0	V_{DD}	V
T_A	Operating Ambient Temperature	-40	+125	°C

Functional operation above the stresses listed in the Recommended Operating Ranges is not implied. Extended exposure to stresses beyond the Recommended Operating Ranges limits may affect device reliability.

FAN3121, FAN3122

ELECTRICAL CHARACTERISTICS ($V_{DD} = 12\text{ V}$ and $T_J = -40^\circ\text{C}$ to $+125^\circ\text{C}$ unless otherwise noted. Currents are defined as positive into the device and negative out of the device.)

Symbol	Parameter	Test Condition	Min	Typ	Max	Unit
--------	-----------	----------------	-----	-----	-----	------

SUPPLY

V_{DD}	Operating Range		4.5	–	18.0	V
I_{DD}	Supply Current, Inputs / EN Not Connected	TTL	–	0.65	0.90	mA
		CMOS (Note 8)	–	0.58	0.85	
V_{ON}	Device Turn-On Voltage (UVLO)		3.5	4.0	4.3	V
V_{OFF}	Device Turn-Off Voltage (UVLO)		3.30	3.75	4.10	V

INPUTS (TTL, FAN312XT) (Note 9)

V_{IL_T}	INx Logic Low Threshold		0.8	1.0	–	V
V_{IH_T}	INx Logic High Threshold		–	1.7	2.0	V
V_{HYS_T}	TTL Logic Hysteresis Voltage		0.40	0.70	0.85	V

FAN3121TMX, FAN3122TMX

I_{IN+}	Non-Inverting Input Current	IN from 0 to V_{DD}	–1	–	175	μA
I_{IN-}	Inverting Input Current	IN from 0 to V_{DD}	–175	–	1	μA

INPUTS (CMOS, FAN312xC) (Note 9)

V_{IL_C}	INx Logic Low Threshold		30	38	–	$\%V_{DD}$
V_{IH_C}	INx Logic High Threshold		–	55	70	$\%V_{DD}$
V_{HYS_C}	CMOS Logic Hysteresis Voltage		12	17	24	$\%V_{DD}$

FAN3121CMX, FAN3122CMX

I_{IN+}	Non-Inverting Input Current	IN from 0 to V_{DD}	–1	–	175	μA
I_{IN-}	Inverting Input Current	IN from 0 to V_{DD}	–175	–	1	μA

ENABLE (FAN3121, FAN3122)

V_{ENL}	Enable Logic Low Threshold	EN from 5 V to 0 V	1.2	1.6	2.0	V
V_{ENH}	Enable Logic High Threshold	EN from 0 V to 5 V	1.8	2.2	2.6	V
V_{HYS_T}	TTL Logic Hysteresis Voltage		0.2	0.6	0.8	V
R_{PU}	Enable Pull-up Resistance		68	100	134	$\text{k}\Omega$
t_{D1}, t_{D2}	Propagation Delay, CMOS EN (Note 10)		8	17	27	ns
t_{D1}, t_{D2}	Propagation Delay, TTL EN (Note 10)		14	21	33	ns

OUTPUTS

I_{SINK}	OUT Current, Mid-Voltage, Sinking (Note 11)	OUT at $V_{DD} / 2$, $C_{LOAD} = 1.0\ \mu\text{F}$, $f = 1\ \text{kHz}$	–	9.7	–	A
I_{SOURCE}	OUT Current, Mid-Voltage, Sourcing (Note 11)	OUT at $V_{DD} / 2$, $C_{LOAD} = 1.0\ \mu\text{F}$, $f = 1\ \text{kHz}$	–	7.1	–	A
I_{PK_SINK}	OUT Current, Peak, Sinking (Note 11)	$C_{LOAD} = 1.0\ \mu\text{F}$, $f = 1\ \text{kHz}$	–	11.4	–	A
I_{PK_SOURCE}	OUT Current, Peak, Sourcing (Note 11)	$C_{LOAD} = 1.0\ \mu\text{F}$, $f = 1\ \text{kHz}$	–	10.6	–	A
t_{RISE}	Output Rise Time (Note 10)	$C_{LOAD} = 10\ \text{nF}$	18	23	29	ns
t_{FALL}	Output Fall Time (Note 10)	$C_{LOAD} = 10\ \text{nF}$	11	19	27	ns
t_{D1}, t_{D2}	Output Propagation Delay, CMOS Inputs (Note 10)	0 – 12 V_{IN} , 1 V/ns Slew Rate	9	18	28	ns
t_{D1}, t_{D2}	Output Propagation Delay, TTL Inputs (Note 10)	0 – 5 V_{IN} , 1 V/ns Slew Rate	9	23	35	ns
I_{RVS}	Output Reverse Current Withstand (Note 11)		1500	–	–	mA

8. Lower supply current due to inactive TTL circuitry.

9. EN inputs have modified TTL thresholds; refer to the ENABLE section.

10. See Timing Diagrams of Figure 8 and Figure 9.

11. Not tested in production.

FAN3121, FAN3122

TIMING DIAGRAMS

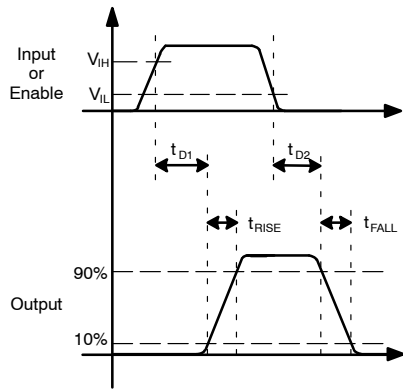

Figure 8. Non-Inverting

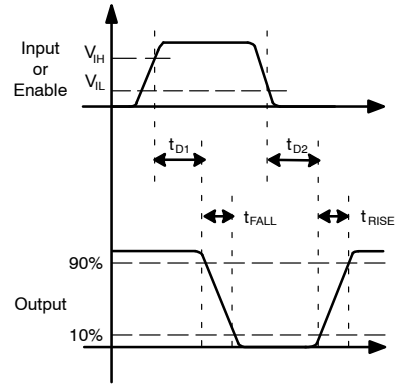

Figure 9. Inverting

FAN3121, FAN3122

TYPICAL PERFORMANCE CHARACTERISTICS

(Typical characteristics are provided at 25°C and V_{DD} = 12 V unless otherwise noted)

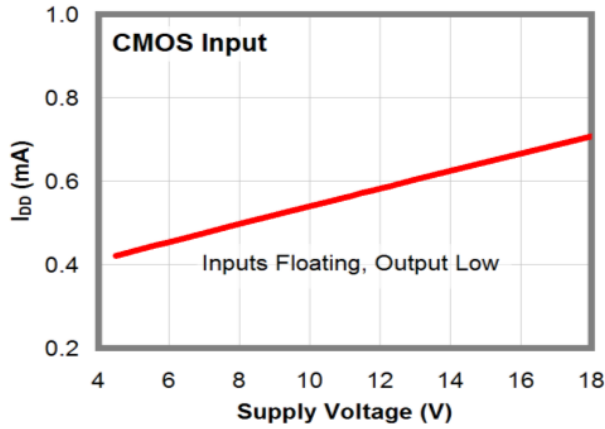

Figure 10. I_{DD} (Static) vs. Supply Voltage (Note 12)

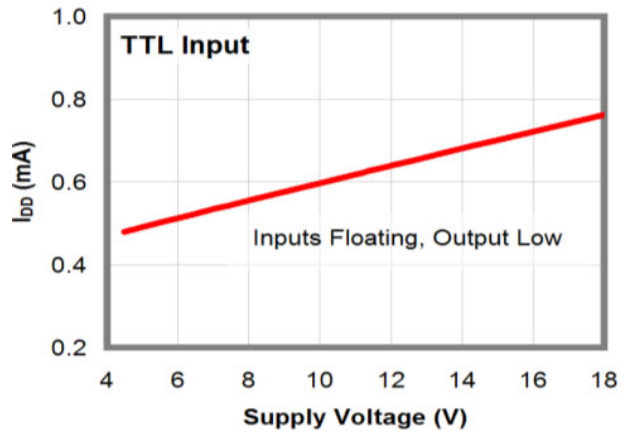

Figure 11. I_{DD} (Static) vs. Supply Voltage (Note 12)

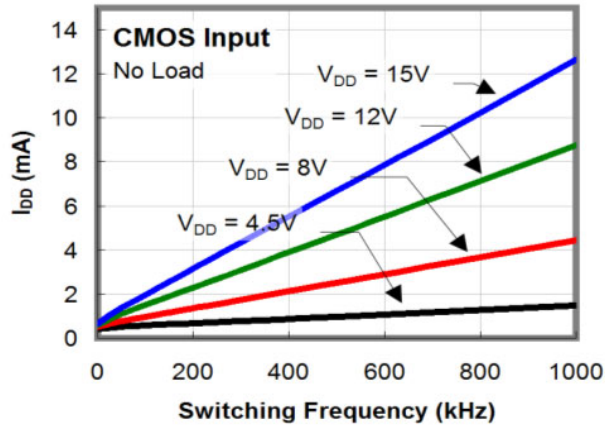

Figure 12. I_{DD} (No-Load) vs. Frequency

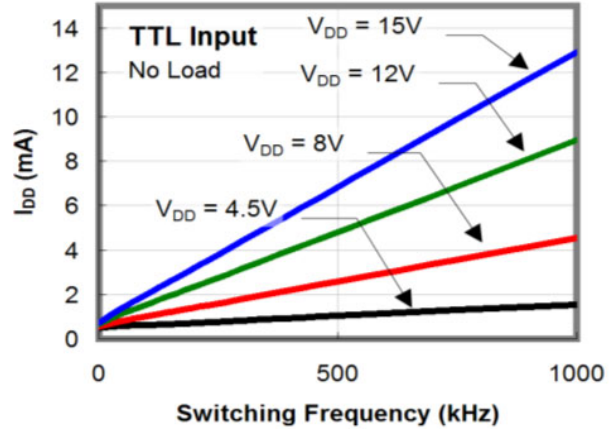

Figure 13. I_{DD} (No-Load) vs. Frequency

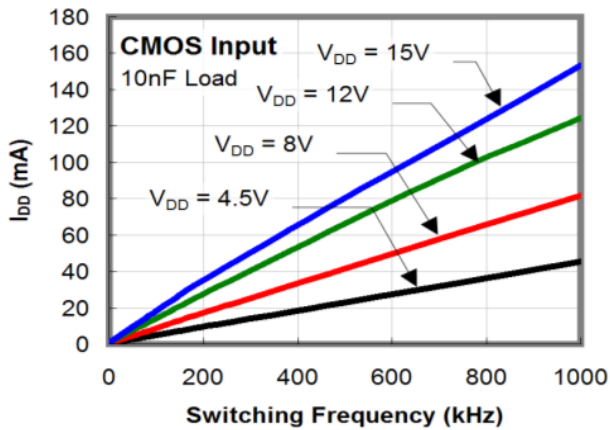

Figure 14. I_{DD} (10 nF Load) vs. Frequency

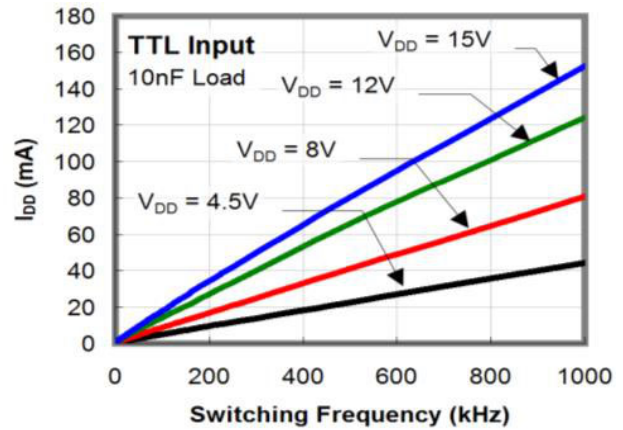

Figure 15. I_{DD} (10 nF Load) vs. Frequency

TYPICAL PERFORMANCE CHARACTERISTICS

(Typical characteristics are provided at 25°C and VDD = 12 V unless otherwise noted) (continued)

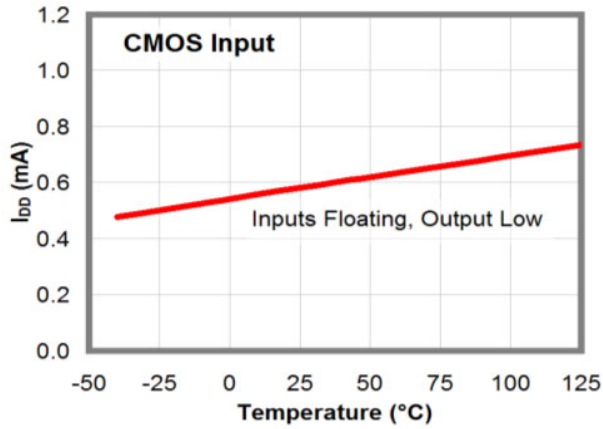

Figure 16. I_{DD} (Static) vs. Temperature (Note 12)

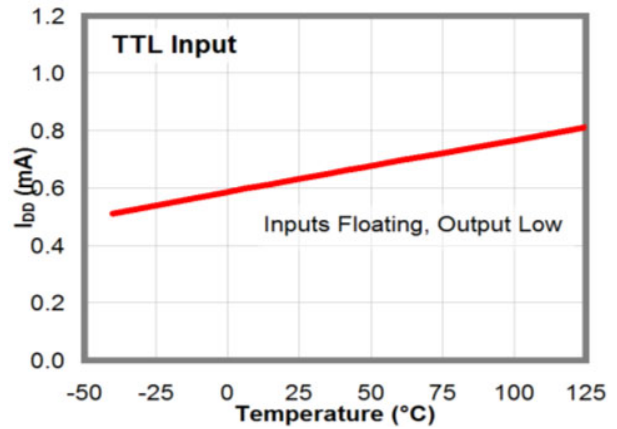

Figure 17. I_{DD} (Static) vs. Temperature (Note 12)

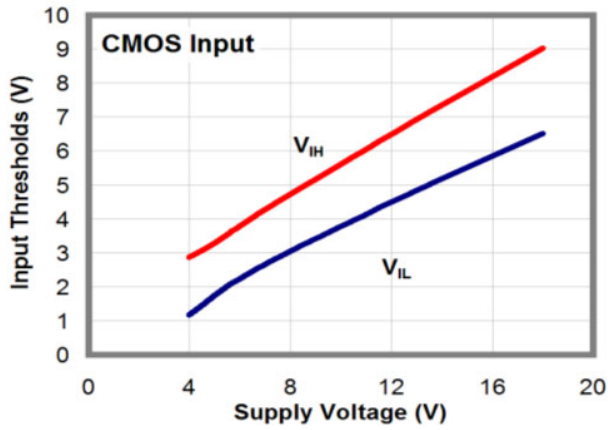

Figure 18. Input Thresholds vs. Supply Voltage

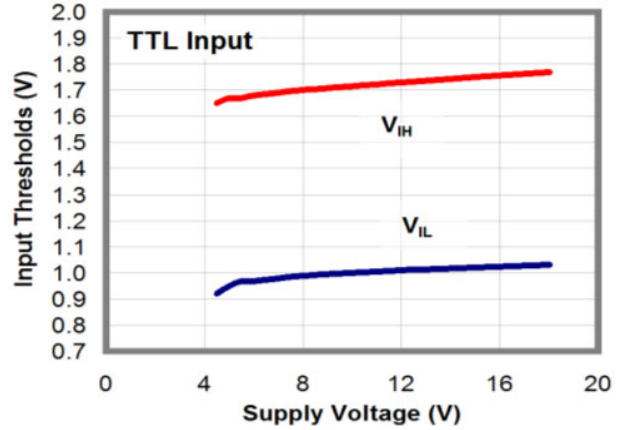

Figure 19. Input Thresholds vs. Supply Voltage

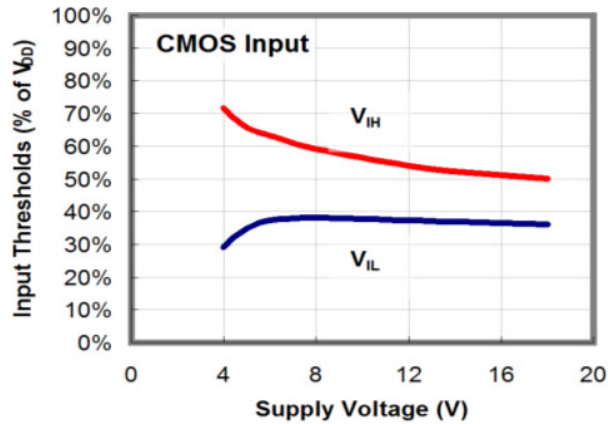

Figure 20. Input Thresholds % vs. Supply Voltage

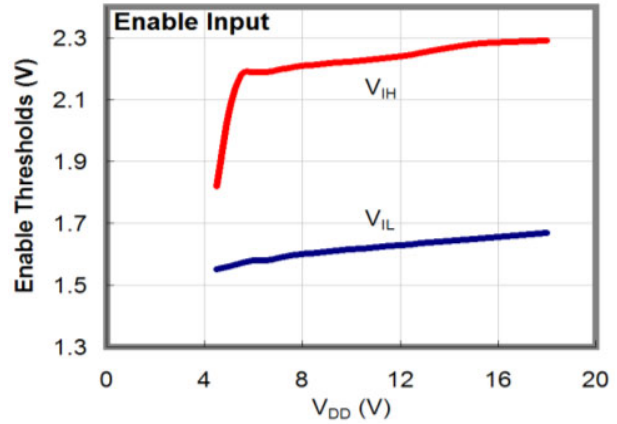

Figure 21. Enable Thresholds vs. Supply Voltage

TYPICAL PERFORMANCE CHARACTERISTICS

(Typical characteristics are provided at 25°C and VDD = 12 V unless otherwise noted) (continued)

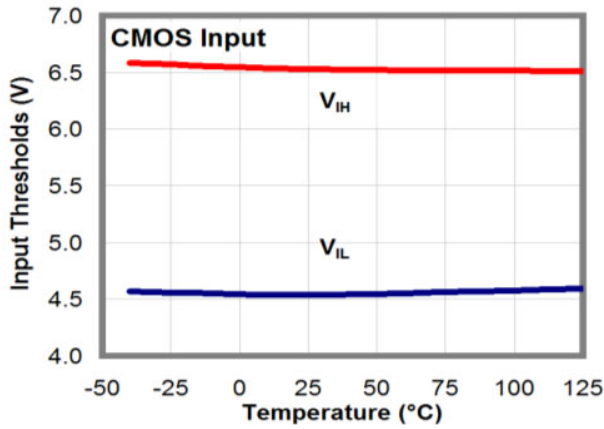

Figure 22. CMOS Input Thresholds vs. Temperature

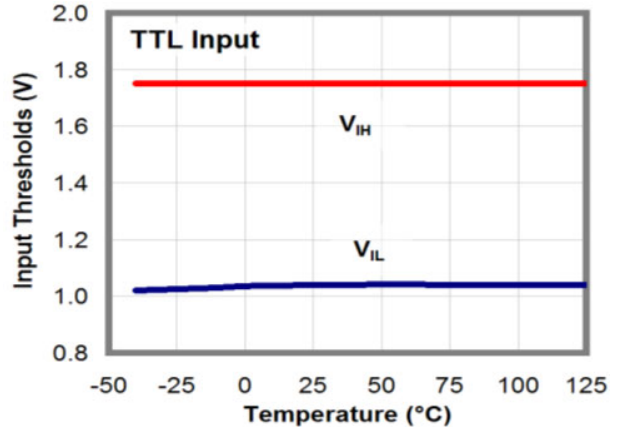

Figure 23. TTL Input Thresholds vs. Temperature

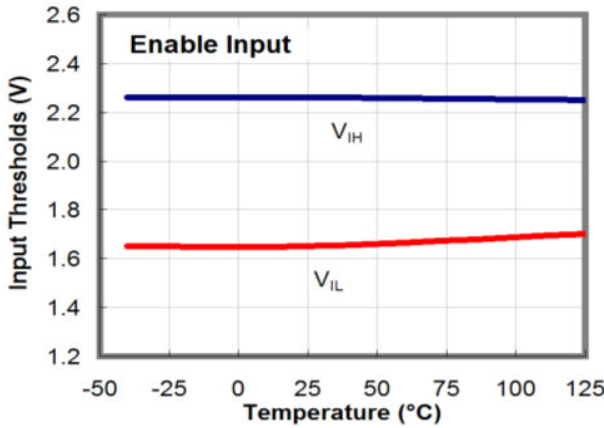

Figure 24. TTL Input Thresholds vs. Temperature

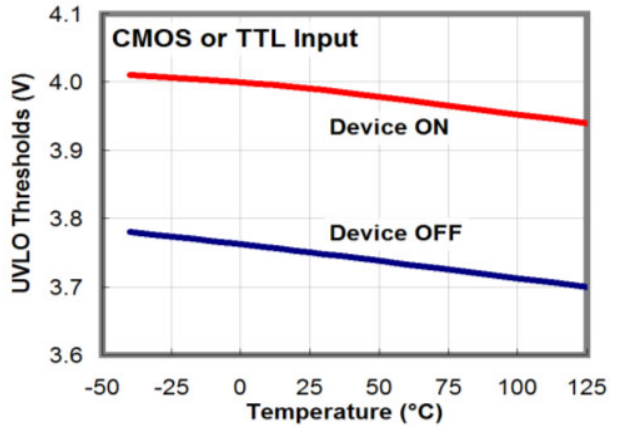

Figure 25. UVLO Thresholds vs. Temperature

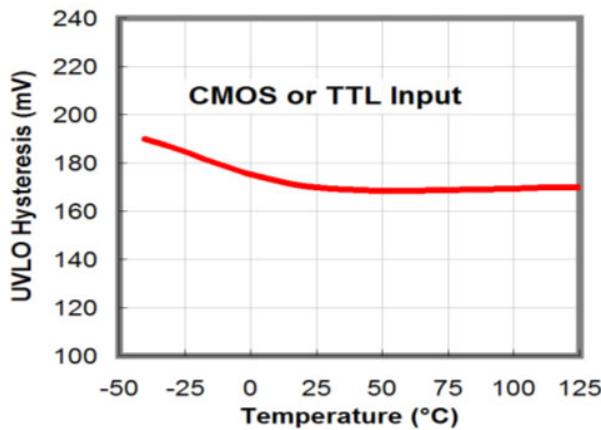

Figure 26. UVLO Hysteresis vs. Temperature

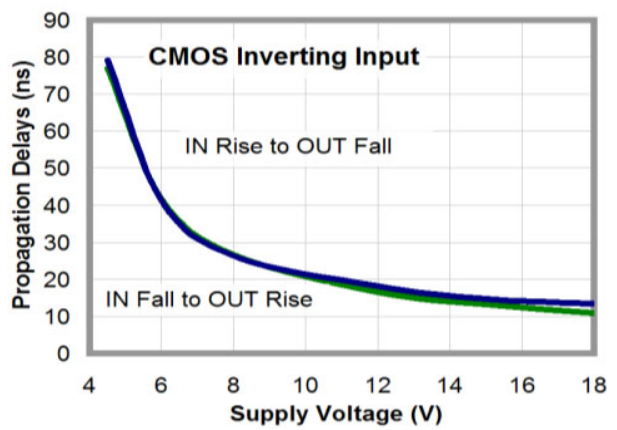

Figure 27. Propagation Delay vs. Supply Voltage

TYPICAL PERFORMANCE CHARACTERISTICS

(Typical characteristics are provided at 25°C and VDD = 12 V unless otherwise noted) (continued)

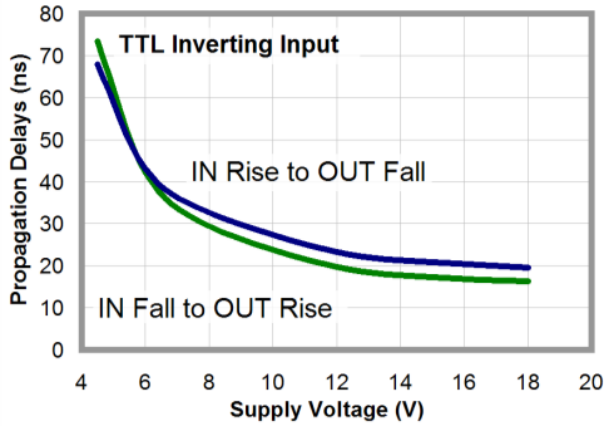

Figure 28. Propagation Delay vs. Supply Voltage

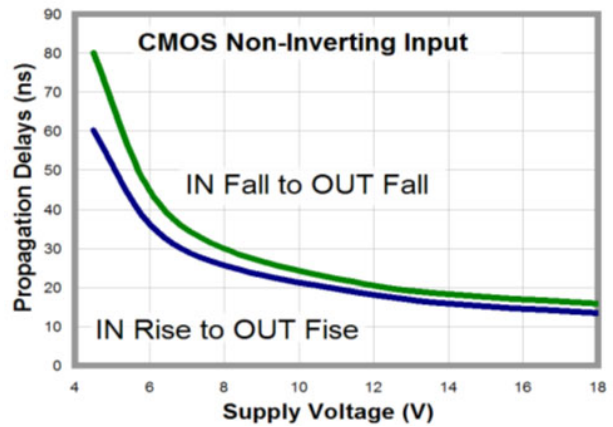

Figure 29. Propagation Delay vs. Supply Voltage

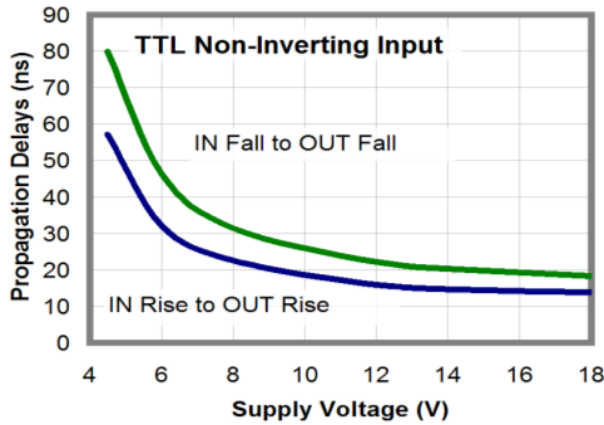

Figure 30. Propagation Delay vs. Supply Voltage

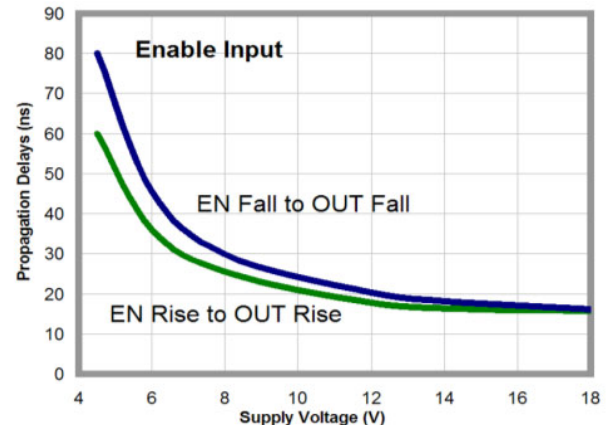

Figure 31. Propagation Delay vs. Supply Voltage

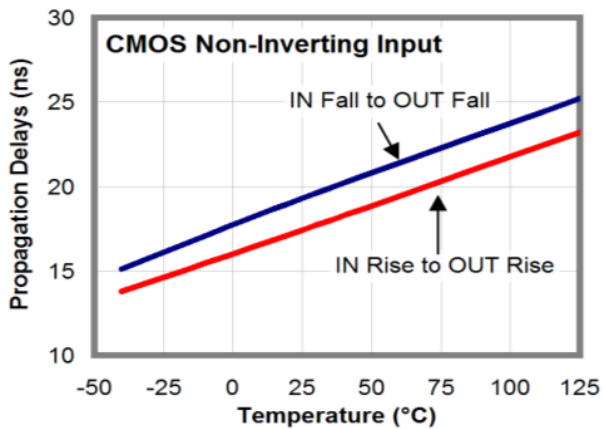

Figure 32. Propagation Delays vs. Temperature

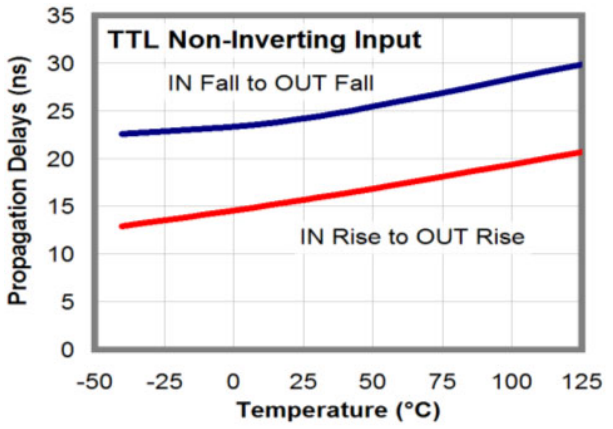

Figure 33. Propagation Delays vs. Temperature

FAN3121, FAN3122

TYPICAL PERFORMANCE CHARACTERISTICS

(Typical characteristics are provided at 25°C and VDD = 12 V unless otherwise noted) (continued)

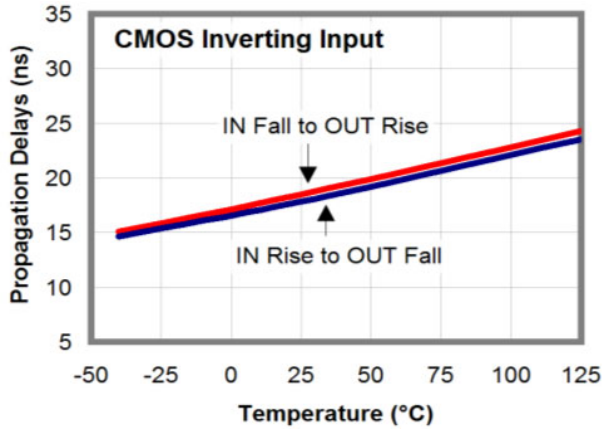

Figure 34. Propagation Delays vs. Temperature

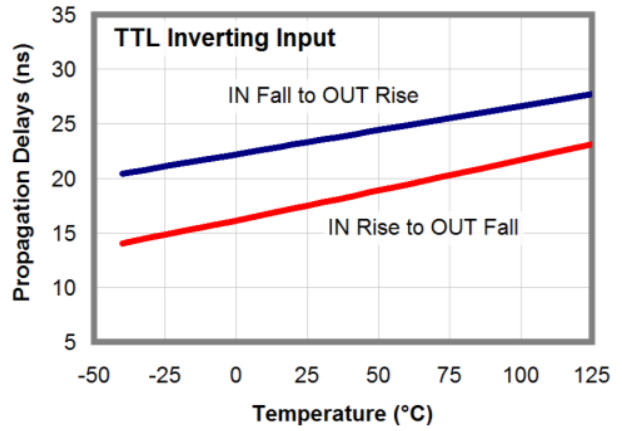

Figure 35. Propagation Delays vs. Temperature

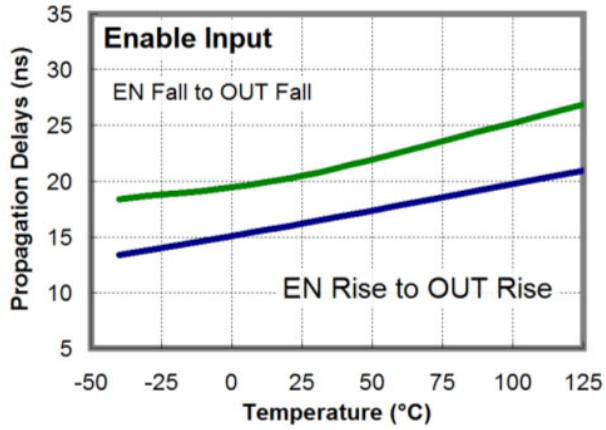

Figure 36. Propagation Delays vs. Temperature

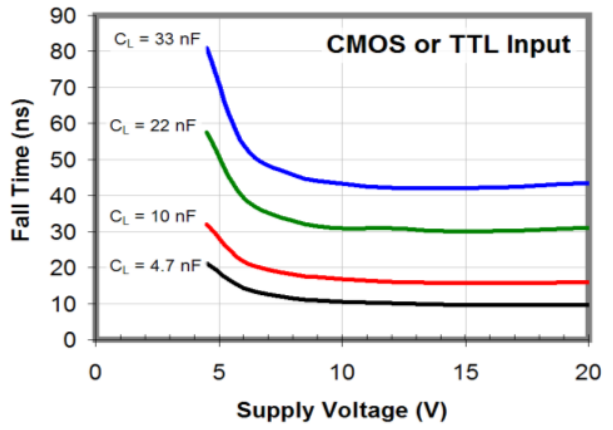

Figure 37. Fall Time vs. Supply Voltage

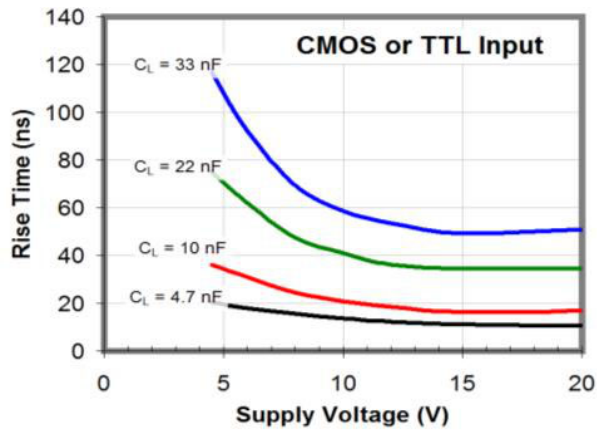

Figure 38. Rise Time vs. Supply Voltage

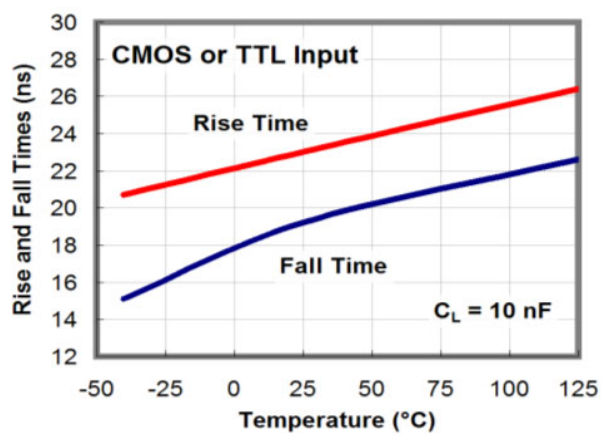

Figure 39. Rise and Fall Time vs. Temperature

FAN3121, FAN3122

TYPICAL PERFORMANCE CHARACTERISTICS

(Typical characteristics are provided at 25°C and V_{DD} = 12 V unless otherwise noted) (continued)

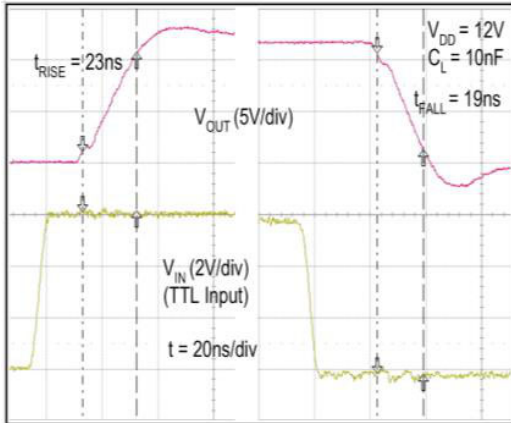

Figure 40. Rise / Fall Waveforms with 10 nF Load

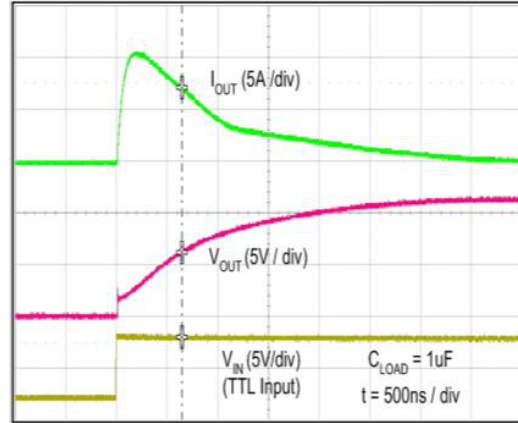

Figure 41. Quasi-Static Source Current with V_{DD} = 12 V (Note 13)

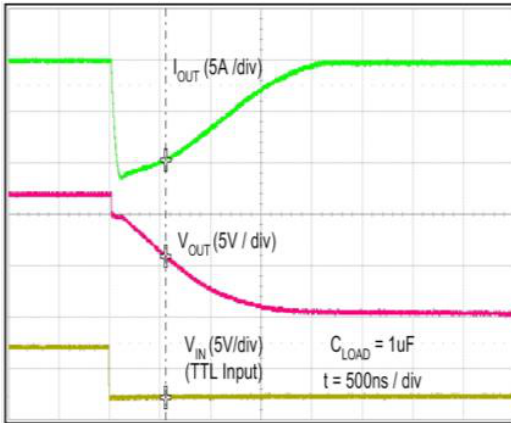

Figure 42. Quasi-Static Sink Current with V_{DD} = 12 V (Note 13)

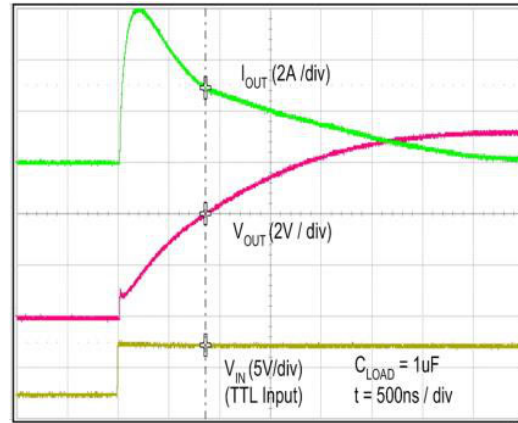

Figure 43. Quasi-Static Source Current with V_{DD} = 8 V (Note 13)

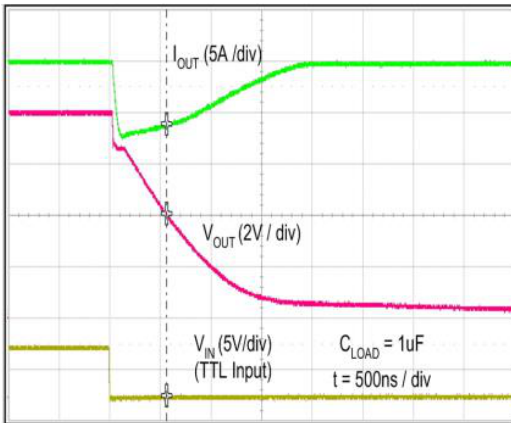

Figure 44. Quasi-Static Sink Current with V_{DD} = 8 V (Note 13)

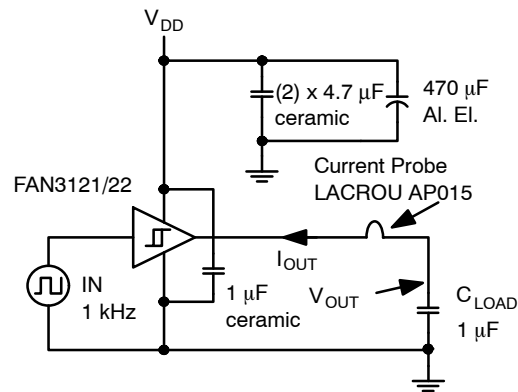

Figure 45. Quasi-Static I_{OUT} / V_{OUT} Test Circuit

12. For any inverting inputs pulled LOW, non-inverting inputs pulled HIGH, or outputs driven HIGH; static I_{DD} increases by the current flowing through the corresponding pull-up/down resistor, shown in Figure 7.

13. The initial spike in each current waveform is a measurement artifact caused by the stray inductance of the current-measurement loop.

APPLICATIONS INFORMATION

The FAN3121 and FAN3122 family offers versions in either TTL or CMOS input configuration. In the FAN3121T and FAN3122T, the input thresholds meet industry-standard TTL-logic thresholds independent of the V_{DD} voltage, and there is a hysteresis voltage of approximately 0.7 V. These levels permit the inputs to be driven from a range of input logic signal levels for which a voltage over 2 V is considered logic HIGH. The driving signal for the TTL inputs should have fast rising and falling edges with a slew rate of 6 V/ μ s or faster, so the rise time from 0 to 3.3 V should be 550 ns or less.

The FAN3121 and FAN3122 output can be enabled or disabled using the EN pin with a very rapid response time. If EN is not externally connected, an internal pull-up resistor enables the driver by default. The EN pin has logic thresholds for parts with either TTL or CMOS IN thresholds.

In the FAN3121C and FAN3122C, the logic input thresholds are dependent on the V_{DD} level and, with V_{DD} of 12 V, the logic rising edge threshold is approximately 55% of V_{DD} and the input falling edge threshold is approximately 38% of V_{DD} . The CMOS input configuration offers a hysteresis voltage of approximately 17% of V_{DD} . The CMOS inputs can be used with relatively slow edges (approaching DC) if good decoupling and bypass techniques are incorporated in the system design to prevent noise from violating the input voltage hysteresis window. This allows setting precise timing intervals by fitting an R-C circuit between the controlling signal and the IN pin of the driver. The slow rising edge at the IN pin of the driver introduces a delay between the controlling signal and the OUT pin of the driver.

Static Supply Current

In the I_{DD} (static) Typical Performance Characteristics, the curves are produced with all inputs / enables floating (OUT is LOW) and indicates the lowest static I_{DD} current for the tested configuration. For other states, additional current flows through the 100 k Ω resistors on the inputs and outputs, as shown in the block diagram (see Figure 7). In these cases, the actual static I_{DD} current is the value obtained from the curves, plus this additional current.

MillerDrive Gate-Drive Technology

FAN312x gate drivers incorporate the MillerDrive architecture shown in Figure 46. For the output stage, a combination of bipolar and MOS devices provide large currents over a wide range of supply voltage and temperature variations. The bipolar devices carry the bulk of the current as OUT swings between 1/3 to 2/3 V_{DD} and the MOS devices pull the output to the HIGH or LOW rail.

The purpose of the Miller Drive architecture is to speed up switching by providing high current during the Miller plateau region when the gate-drain capacitance of the MOSFET is being charged or discharged as part of the turn-on / turn-off process.

For applications with zero voltage switching during the MOSFET turn-on or turn-off interval, the driver supplies high peak current for fast switching, even though the Miller plateau is not present. This situation often occurs in synchronous rectifier applications because the body diode is generally conducting before the MOSFET is switched on.

The output pin slew rate is determined by V_{DD} voltage and the load on the output. It is not user adjustable, but a series resistor can be added if a slower rise or fall time at the MOSFET gate is needed.

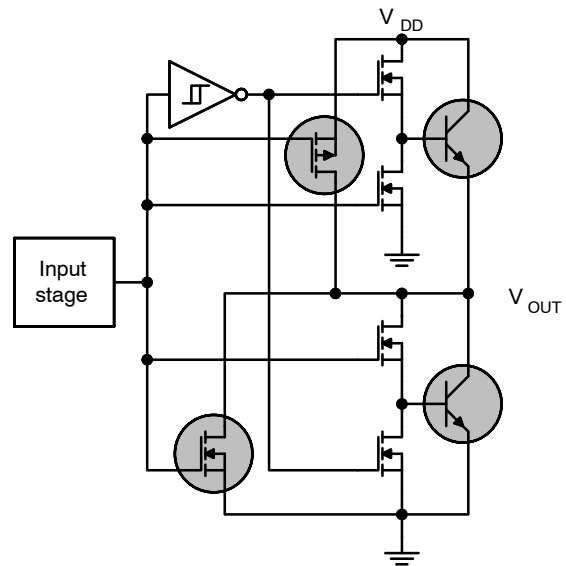

Figure 46. Miller Drive Output Architecture

Under-Voltage Lockout (UVLO)

The FAN312x startup logic is optimized to drive ground-referenced N-channel MOSFETs with an under-voltage lockout (UVLO) function to ensure that the IC starts in an orderly fashion. When V_{DD} is rising, yet below the 4.0 V operational level, this circuit holds the output low, regardless of the status of the input pins. After the part is active, the supply voltage must drop 0.25 V before the part shuts down. This hysteresis helps prevent chatter when low V_{DD} supply voltages have noise from the power switching. This configuration is not suitable for driving high-side P-channel MOSFETs because the low output voltage of the driver would turn the P-channel MOSFET on with V_{DD} below 4.0 V.

V_{DD} Bypassing and Layout Considerations

The FAN3121 and FAN3122 are available in either 8-lead SOIC or MLP packages. In either package, the V_{DD} pins 1 and 8 and the GND pins 4 and 5 should be connected together on the PCB.

In typical FAN312x gate-driver applications, high-current pulses are needed to charge and discharge the gate of a power MOSFET in time intervals of 50 ns or less. A bypass capacitor with low ESR and ESL should be connected directly between the V_{DD} and GND pins to provide these large current pulses without causing unacceptable ripple on the V_{DD} supply. To meet these requirements in a small size, a ceramic capacitor of 1 μF or larger is typically used, with a dielectric material such as X7R, to limit the change in capacitance over the temperature and / or voltage application ranges.

Figure 47 shows the pulsed gate drive current path when the gate driver is supplying gate charge to turn the MOSFET on. The current is supplied from the local bypass capacitor C_{BYP} and flows through the driver to the MOSFET gate and to ground. To reach the high peak currents possible with the FAN312x family, the resistance and inductance in the path should be minimized. The localized C_{BYP} acts to contain the high peak current pulses within this driver-MOSFET circuit, preventing them from disturbing the sensitive analog circuitry in the PWM controller.

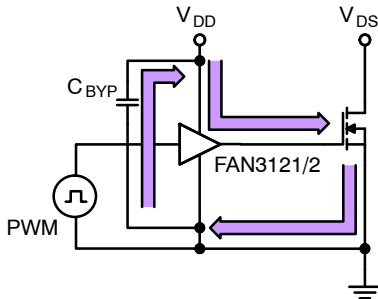

Figure 47. Current Path for MOSFET Turn-On

Figure 48 shows the path the current takes when the gate driver turns the MOSFET off. Ideally, the driver shunts the current directly to the source of the MOSFET in a small circuit loop. For fast turn-off times, the resistance and inductance in this path should be minimized.

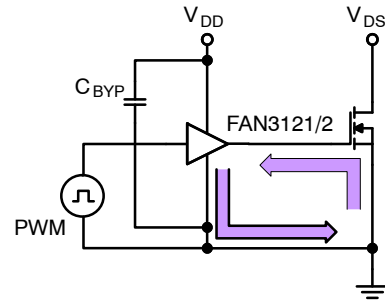

Figure 48. Current Path for MOSFET Turn-Off

Operational Waveforms

At power up, the FAN3121 inverting driver shown in Figure 49 holds the output LOW until the V_{DD} voltage reaches the UVLO turn-on threshold, as indicated in Figure 50. This facilitates proper startup control of low-side N-channel MOSFETs.

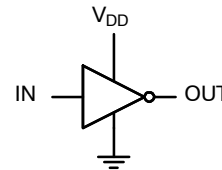

Figure 49. Inverting Configuration

The OUT pulses' magnitude follows V_{DD} magnitude with the output polarity inverted from the input until steady-state V_{DD} is reached.

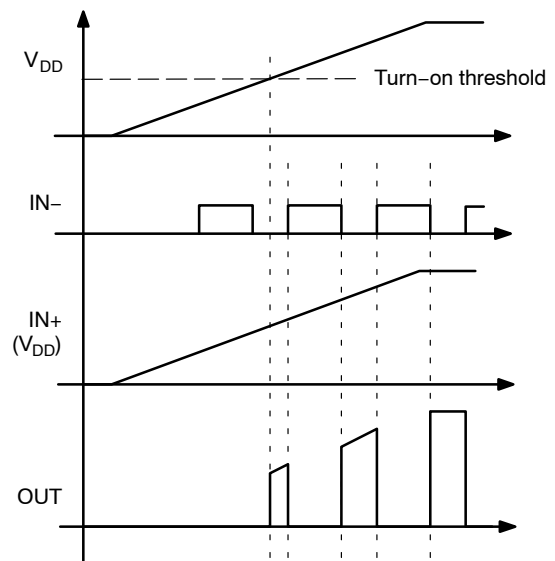

Figure 50. Inverting Startup Waveforms

At power up, the FAN3122 non-inverting driver, shown in Figure 51, holds the output LOW until the V_{DD} voltage reaches the UVLO turn-on threshold, as indicated in Figure 52. The OUT pulses magnitude follow V_{DD} magnitude until steady-state V_{DD} is reached.

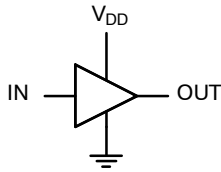

Figure 51. Non-Inverting Driver

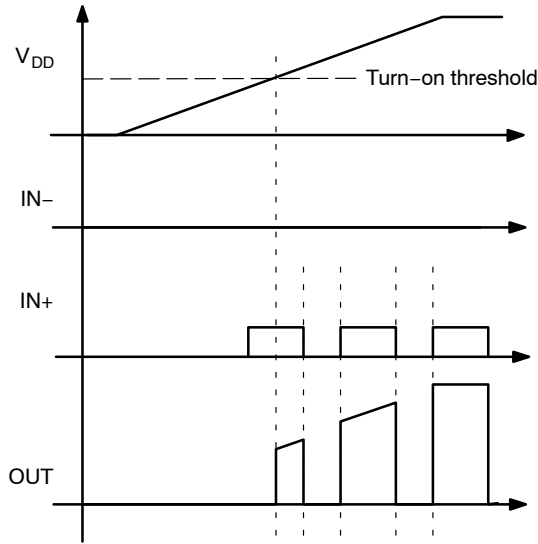

Figure 52. Non-Inverting Startup Waveforms

Thermal Guidelines

Gate drivers used to switch MOSFETs and IGBTs at high frequencies can dissipate significant amounts of power. It is important to determine the driver power dissipation and the resulting junction temperature in the application to ensure that the part is operating within acceptable temperature limits.

The total power dissipation in a gate driver is the sum of two components, P_{GATE} and $P_{DYNAMIC}$:

$$P_{TOTAL} = P_{GATE} + P_{DYNAMIC} \quad (eq. 1)$$

Gate Driving Loss: The most significant power loss results from supplying gate current (charge per unit time) to switch the load MOSFET on and off at the switching frequency. The power dissipation that results from driving a MOSFET at a specified gate-source voltage, V_{GS} , with gate charge, Q_G , at switching frequency, f_{SW} , is determined by:

$$P_{GATE} = Q_G \cdot V_{GS} \cdot f_{SW} \quad (eq. 2)$$

Dynamic Pre-drive / Shoot-through Current: A power loss resulting from internal current consumption under

dynamic operating conditions, including pin pull-up / pull-down resistors, can be obtained using graphs in Typical Performance Characteristics to determine the current $I_{DYNAMIC}$ drawn from V_{DD} under actual operating conditions:

$$P_{DYNAMIC} = I_{DYNAMIC} \cdot V_{DD} \quad (eq. 3)$$

Once the power dissipated in the driver is determined, the driver junction rise with respect to circuit board can be evaluated using the following thermal equation, assuming ψ_{JB} was determined for a similar thermal design (heat sinking and air flow):

$$T_J = P_{TOTAL} \cdot \psi_{JB} + T_B \quad (eq. 4)$$

where:

T_J = driver junction temperature;

ψ_{JB} = (psi) thermal characterization parameter relating temperature rise to total power dissipation; and

T_B = board temperature in location as defined in the [Thermal Characteristics](#) table.

In a full-bridge synchronous rectifier application, shown in Figure 53, each FAN3122 drives a parallel combination of two high-current MOSFETs, (such as FDMS8660S). The typical gate charge for each SR MOSFET is 70 nC with $V_{GS} = V_{DD} = 9$ V. At a switching frequency of 300 kHz, the total power dissipation is:

$$P_{GATE} = 2 \cdot 70 \text{ nC} \cdot 9 \text{ V} \cdot 300 \text{ kHz} = 0.378 \text{ W} \quad (eq. 5)$$

$$P_{DYNAMIC} = 2 \text{ mA} \cdot 9 \text{ V} = 18 \text{ mW} \quad (eq. 6)$$

$$P_{TOTAL} = 0.396 \text{ W} \quad (eq. 7)$$

The SOIC-8 has a junction-to-board thermal characterization parameter of $\psi_{JB} = 42^\circ\text{C/W}$. In a system application, the localized temperature around the device is a function of the layout and construction of the PCB along with airflow across the surfaces. To ensure reliable operation, the maximum junction temperature of the device must be prevented from exceeding the maximum rating of 150°C ; with 80% derating, T_J would be limited to 120°C . Rearranging Equation 4 determines the board temperature required to maintain the junction temperature below 120°C :

$$T_{B,MAX} = T_J - P_{TOTAL} \cdot \psi_{JB} \quad (eq. 8)$$

$$T_{B,MAX} = 120^\circ\text{C} - 0.396 \text{ W} \cdot 42^\circ\text{C/W} = 104^\circ\text{C} \quad (eq. 9)$$

For comparison, replace the SOIC-8 used in the previous example with the 3x3 mm MLP package with $\psi_{JB} = 2.8^\circ\text{C/W}$. The 3x3 mm MLP package can operate at a PCB temperature of 118°C , while maintaining the junction temperature below 120°C . This illustrates that the physically smaller MLP package with thermal pad offers a more conductive path to remove the heat from the driver. Consider tradeoffs between reducing overall circuit size with junction temperature reduction for increased reliability.

Typical Application Diagrams

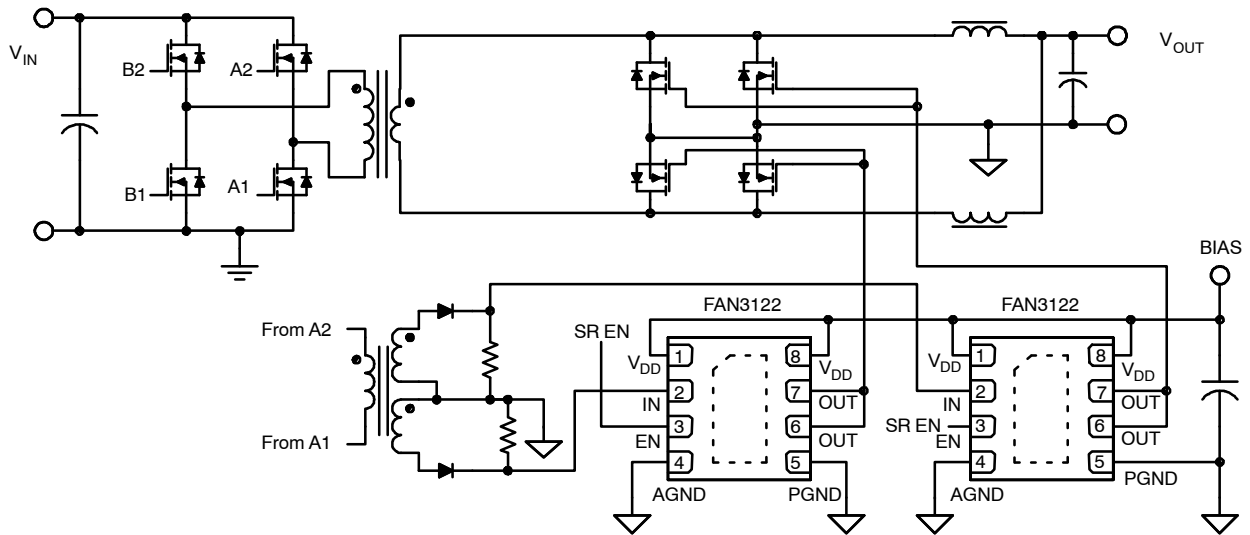

Figure 53. Full-Bridge Synchronous Rectification

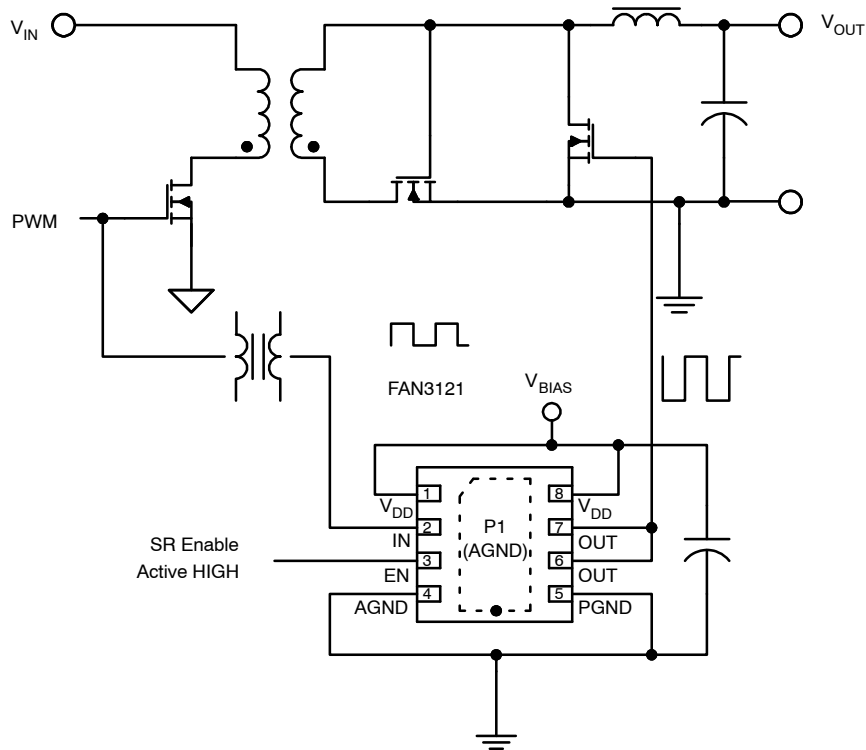

Figure 54. Hybrid Synchronous Rectification in a Forward Converter

FAN3121, FAN3122

ORDERING INFORMATION

Part Number	Logic	Input Threshold	Package	Shipping [†]
FAN3121CMPX	Inverting Channels + Enable	CMOS	3x3 mm MLP-8	3,000 / Tape & Reel
FAN3121CMX			SOIC-8	2,500 / Tape & Reel
FAN3121TMPX		TTL	3x3 mm MLP-8	3,000 / Tape & Reel
FAN3121TMX			SOIC-8	2,500 / Tape & Reel
FAN3122CMPX	Non-Inverting Channels + Enable	CMOS	3x3 mm MLP-8	3,000 / Tape & Reel
FAN3122CMX			SOIC-8	2,500 / Tape & Reel
FAN3122TMPX		TTL	3x3 mm MLP-8	3,000 / Tape & Reel
FAN3122TMX			SOIC-8	2,500 / Tape & Reel

†For information on tape and reel specifications, including part orientation and tape sizes, please refer to our Tape and Reel Packaging Specifications Brochure, BRD8011/D.

FAN3121, FAN3122

Table 1. RELATED PRODUCTS

Part Number	Type	Gate Drive (Note 14) (Sink/Src)	Input Threshold	Logic	Package
FAN3111C	Single 1 A	+1.1 A / -0.9 A	CMOS	Single Channel of Dual-Input / Single-Output	SOT23-5, MLP6
FAN3111E	Single 1 A	+1.1 A / -0.9 A	External	Single Non-Inverting Channel with External Reference	SOT23-5, MLP6
FAN3100C	Single 2 A	+2.5 A / -1.8 A	CMOS	Single Channel of Two-Input / One-Output	SOT23-5, MLP6
FAN3100T	Single 2 A	+2.5 A / -1.8 A	TTL	Single Channel of Two-Input / One-Output	SOT23-5, MLP6
FAN3180	Single 2 A	+2.4 A / -1.6 A	TTL	Single Non-Inverting Channel + 3.3 V LDO	SOT23-5
FAN3216T	Dual 2 A	+2.4 A / -1.6 A	TTL	Dual Inverting Channels	SOIC8
FAN3217T	Dual 2 A	+2.4 A / -1.6 A	TTL	Dual Non-Inverting Channels	SOIC8
FAN3226C	Dual 2 A	+2.4 A / -1.6 A	CMOS	Dual Inverting Channels + Dual Enable	SOIC8, MLP8
FAN3226T	Dual 2 A	+2.4 A / -1.6 A	TTL	Dual Inverting Channels + Dual Enable	SOIC8, MLP8
FAN3227C	Dual 2 A	+2.4 A / -1.6 A	CMOS	Dual Non-Inverting Channels + Dual Enable	SOIC8, MLP8
FAN3227T	Dual 2 A	+2.4 A / -1.6 A	TTL	Dual Non-Inverting Channels + Dual Enable	SOIC8, MLP8
FAN3228C	Dual 2 A	+2.4 A / -1.6 A	CMOS	Dual Channels of Two-Input / One-Output	SOIC8, MLP8
FAN3228T	Dual 2A	+2.4 A / -1.6 A	TTL	Dual Channels of Two-Input / One-Output	SOIC8, MLP8
FAN3229C	Dual 2 A	+2.4 A / -1.6 A	CMOS	Dual Channels of Two-Input / One-Output	SOIC8, MLP8
FAN3229T	Dual 2 A	+2.4 A / -1.6 A	TTL	Dual Channels of Two-Input / One-Output	SOIC8, MLP8
FAN3268T	Dual 2 A	+2.4 A / -1.6 A	TTL	20 V Non-Inverting Channel (NMOS) and Inverting Channel (PMOS) + Dual Enables	SOIC8
FAN3278T	Dual 2 A	+2.4 A / -1.6 A	TTL	30 V Non-Inverting Channel (NMOS) and Inverting Channel (PMOS) + Dual Enables	SOIC8
FAN3223C	Dual 4 A	+4.3 A / -2.8 A	CMOS	Dual Inverting Channels + Dual Enable	SOIC8, MLP8
FAN3213T	Dual 4 A	+4.3 A / -2.8 A	TTL	Dual Inverting Channels	SOIC8
FAN3214T	Dual 4 A	+4.3 A / -2.8 A	TTL	Dual Non-Inverting Channels	SOIC8
FAN3223T	Dual 4 A	+4.3 A / -2.8 A	TTL	Dual Inverting Channels + Dual Enable	SOIC8, MLP8
FAN3224C	Dual 4 A	+4.3 A / -2.8 A	CMOS	Dual Non-Inverting Channels + Dual Enable	SOIC8, MLP8
FAN3224T	Dual 4 A	+4.3 A / -2.8 A	TTL	Dual Non-Inverting Channels + Dual Enable	SOIC8, MLP8
FAN3225C	Dual 4 A	+4.3 A / -2.8 A	CMOS	Dual Channels of Two-Input / One-Output	SOIC8, MLP8
FAN3225T	Dual 4 A	+4.3 A / -2.8 A	TTL	Dual Channels of Two-Input / One-Output	SOIC8, MLP8
FAN3121C	Single 9 A	+9.7 A / -7.1 A	CMOS	Single Inverting Channel + Enable	SOIC8, MLP8
FAN3121T	Single 9 A	+9.7 A / -7.1 A	TTL	Single Inverting Channel + Enable	SOIC8, MLP8
FAN3122C	Single 9 A	+9.7 A / -7.1 A	CMOS	Single Non-Inverting Channel + Enable	SOIC8, MLP8
FAN3122T	Single 9 A	+9.7 A / -7.1 A	TTL	Single Non-Inverting Channel + Enable	SOIC8, MLP8
FAN3240	Dual 12 A	> +12.0 A	TTL	Dual-Coil Relay Driver, Timing Config. 0	SOIC8
FAN3241	Dual 12 A	> +12.0 A	TTL	Dual-Coil Relay Driver, Timing Config. 1	SOIC8

14. Typical currents with OUT at 6 V and $V_{DD} = 12$ V.

15. Thresholds proportional to an externally supplied reference voltage.

FAN3121, FAN3122

PACKAGE DIMENSIONS

SOIC8
CASE 751EB
ISSUE A

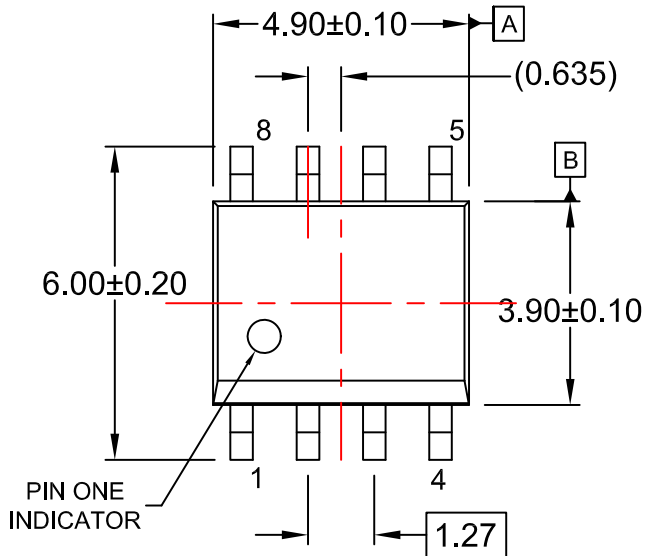

\varnothing	0.25(M)	C	B	A
---------------	---------	---	---	---

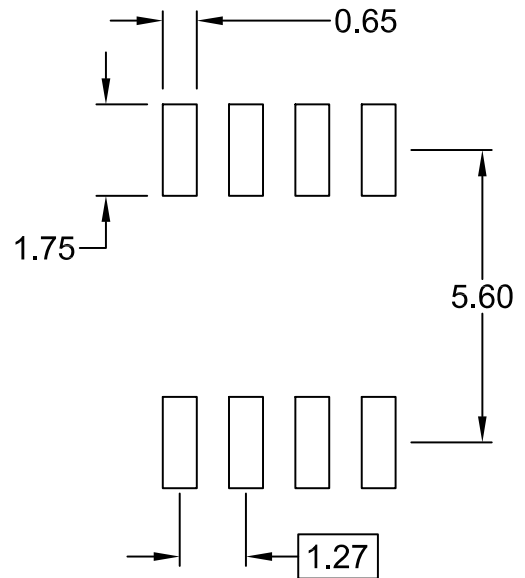

LAND PATTERN RECOMMENDATION

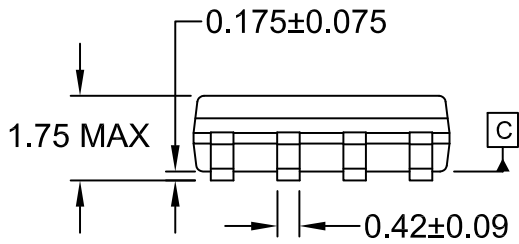

$\frac{1}{2}$	0.10
---------------	------

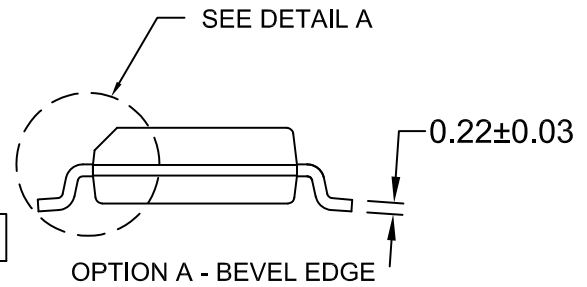

OPTION A - BEVEL EDGE

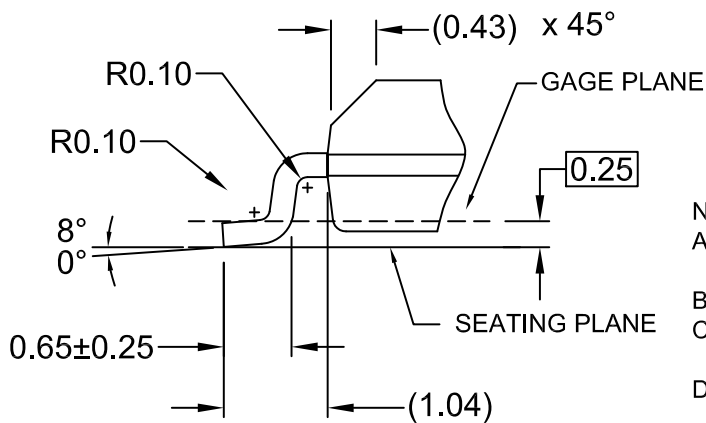

DETAIL A
SCALE: 2:1

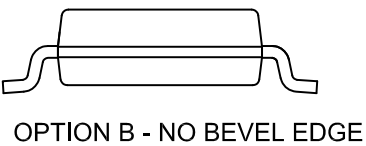

OPTION B - NO BEVEL EDGE

NOTES:

- A) THIS PACKAGE CONFORMS TO JEDEC MS-012, VARIATION AA.
- B) ALL DIMENSIONS ARE IN MILLIMETERS.
- C) DIMENSIONS DO NOT INCLUDE MOLD FLASH OR BURRS.
- D) LANDPATTERN STANDARD: SOIC127P600X175-8M

FAN3121, FAN3122

PACKAGE DIMENSIONS

WDFN8 3x3, 0.65P
CASE 511CD
ISSUE O

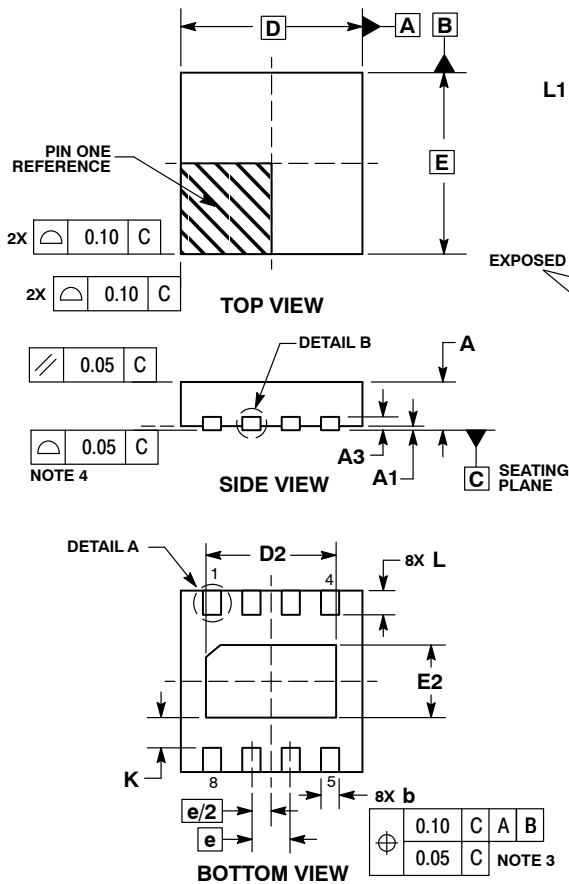

NOTES:

1. DIMENSIONING AND TOLERANCING PER ASME Y14.5M, 1994.
2. CONTROLLING DIMENSION: MILLIMETERS.
3. DIMENSION b APPLIES TO PLATED TERMINAL AND IS MEASURED BETWEEN 0.15 AND 0.30 MM FROM TERMINAL TIP.
4. COPLANARITY APPLIES TO THE EXPOSED PAD AS WELL AS THE TERMINALS.

MILLIMETERS		
DIM	MIN	MAX
A	0.70	0.80
A1	0.00	0.05
A3	0.20	REF
b	0.25	0.35
D	3.00	BSC
D2	2.05	2.25
E	3.00	BSC
E2	1.10	1.30
e	0.65	BSC
K	0.20	---
L	0.30	0.50
L1	0.00	0.15

RECOMMENDED SOLDERING FOOTPRINT*

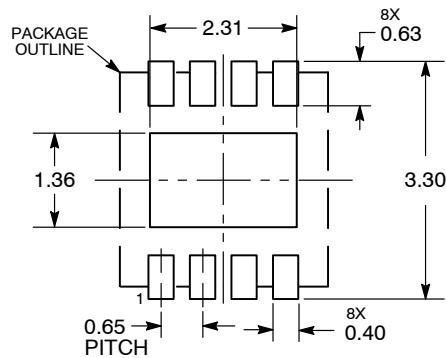

DIMENSIONS: MILLIMETERS

*For additional information on our Pb-Free strategy and soldering details, please download the ON Semiconductor Soldering and Mounting Techniques Reference Manual, SOLDERRM/D.

MillerDrive is trademark of Semiconductor Components Industries, LLC (SCILLC) or its subsidiaries in the United States and/or other countries.

ON Semiconductor and are trademarks of Semiconductor Components Industries, LLC dba ON Semiconductor or its subsidiaries in the United States and/or other countries. ON Semiconductor owns the rights to a number of patents, trademarks, copyrights, trade secrets, and other intellectual property. A listing of ON Semiconductor's product/patent coverage may be accessed at www.onsemi.com/site/pdf/Patent-Marking.pdf. ON Semiconductor reserves the right to make changes without further notice to any products herein. ON Semiconductor makes no warranty, representation or guarantee regarding the suitability of its products for any particular purpose, nor does ON Semiconductor assume any liability arising out of the application or use of any product or circuit, and specifically disclaims any and all liability, including without limitation special, consequential or incidental damages. Buyer is responsible for its products and applications using ON Semiconductor products, including compliance with all laws, regulations and safety requirements or standards, regardless of any support or applications information provided by ON Semiconductor. "Typical" parameters which may be provided in ON Semiconductor data sheets and/or specifications can and do vary in different applications and actual performance may vary over time. All operating parameters, including "Typicals" must be validated for each customer application by customer's technical experts. ON Semiconductor does not convey any license under its patent rights nor the rights of others. ON Semiconductor products are not designed, intended, or authorized for use as a critical component in life support systems or any FDA Class 3 medical devices or medical devices with a same or similar classification in a foreign jurisdiction or any devices intended for implantation in the human body. Should Buyer purchase or use ON Semiconductor products for any such unintended or unauthorized application, Buyer shall indemnify and hold ON Semiconductor and its officers, employees, subsidiaries, affiliates, and distributors harmless against all claims, costs, damages, and expenses, and reasonable attorney fees arising out of, directly or indirectly, any claim of personal injury or death associated with such unintended or unauthorized use, even if such claim alleges that ON Semiconductor was negligent regarding the design or manufacture of the part. ON Semiconductor is an Equal Opportunity/Affirmative Action Employer. This literature is subject to all applicable copyright laws and is not for resale in any manner.

PUBLICATION ORDERING INFORMATION

LITERATURE FULFILLMENT:
Email Requests to: orderlit@onsemi.com

TECHNICAL SUPPORT
North American Technical Support:
Voice Mail: 1 800-282-9855 Toll Free USA/Canada
Phone: 011 421 33 790 2910

Europe, Middle East and Africa Technical Support:
Phone: 00421 33 790 2910
For additional information, please contact your local Sales Representative



Стандарт Электрон Связь

Мы молодая и активно развивающаяся компания в области поставок электронных компонентов. Мы поставляем электронные компоненты отечественного и импортного производства напрямую от производителей и с крупнейших складов мира.

Благодаря сотрудничеству с мировыми поставщиками мы осуществляем комплексные и плановые поставки широчайшего спектра электронных компонентов.

Собственная эффективная логистика и склад в обеспечивает надежную поставку продукции в точно указанные сроки по всей России.

Мы осуществляем техническую поддержку нашим клиентам и предпродажную проверку качества продукции. На все поставляемые продукты мы предоставляем гарантию .

Осуществляем поставки продукции под контролем ВП МО РФ на предприятия военно-промышленного комплекса России , а также работаем в рамках 275 ФЗ с открытием отдельных счетов в уполномоченном банке. Система менеджмента качества компании соответствует требованиям ГОСТ ISO 9001.

Минимальные сроки поставки, гибкие цены, неограниченный ассортимент и индивидуальный подход к клиентам являются основой для выстраивания долгосрочного и эффективного сотрудничества с предприятиями радиоэлектронной промышленности, предприятиями ВПК и научно-исследовательскими институтами России.

С нами вы становитесь еще успешнее!

Наши контакты:

Телефон: +7 812 627 14 35

Электронная почта: sales@st-electron.ru

Адрес: 198099, Санкт-Петербург,
Промышленная ул, дом № 19, литера Н,
помещение 100-Н Офис 331