

### FEATURES

- High common-mode transient immunity: 100 kV/μs**
- High robustness to radiated and conducted noise**
- Low propagation delay**
  - 13 ns maximum for 5 V operation
  - 15 ns maximum for 1.8 V operation
- 150 Mbps maximum guaranteed data rate**
- Safety and regulatory approvals (pending)**
  - UL recognition: 3000 V rms for 1 minute per UL 1577
  - CSA Component Acceptance Notice 5A
  - VDE certificate of conformity
  - DIN V VDE V 0884-10 (VDE V 0884-10):2006-12
  - $V_{IORM} = 565$  V peak
  - CQC certification per GB4943.1-2011
- Low dynamic power consumption**
- 1.8 V to 5 V level translation**
- High temperature operation: 125°C**
- Fail-safe high or low options**
- 16-lead, RoHS compliant, narrow-body SOIC package**

### APPLICATIONS

- General-purpose multichannel isolation
- Serial peripheral interface (SPI)/data converter isolation
- Industrial field bus isolation

### GENERAL DESCRIPTION

The ADuM150N/ADuM151N/ADuM152N<sup>1</sup> are 5-channel digital isolators based on Analog Devices, Inc., *iCoupler*<sup>®</sup> technology. Combining high speed, complementary metal-oxide semiconductor (CMOS) and monolithic air core transformer technology, these isolation components provide outstanding performance characteristics superior to alternatives such as optocoupler devices and other integrated couplers. The maximum propagation delay is 13 ns with a pulse width distortion of less than 4.5 ns at 5 V operation. Channel to channel matching of propagation delay is tight at 4.0 ns maximum.

The ADuM150N/ADuM151N/ADuM152N data channels are independent and are available in a variety of configurations with a withstand voltage rating of 3.0 kV rms (see the Ordering Guide). The devices operate with the supply voltage on either side ranging from 1.7 V to 5.5 V, providing compatibility with lower voltage systems as well as enabling voltage translation functionality across the isolation barrier.

### FUNCTIONAL BLOCK DIAGRAMS

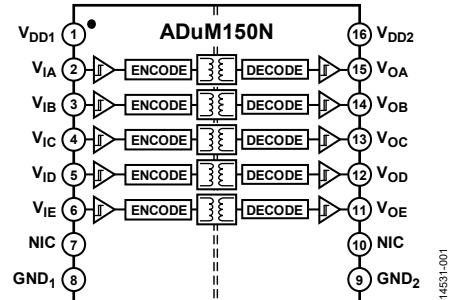

Figure 1. ADuM150N Functional Block Diagram

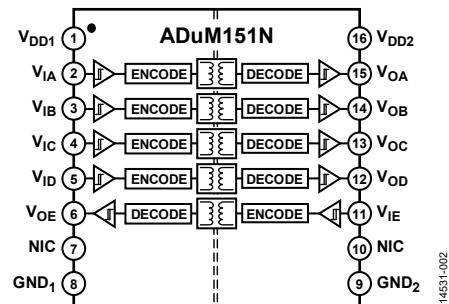

Figure 2. ADuM151N Functional Block Diagram

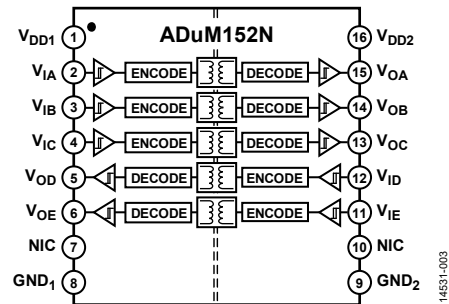

Figure 3. ADuM152N Functional Block Diagram

Unlike other optocoupler alternatives, dc correctness is ensured in the absence of input logic transitions. Two different fail-safe options are available by which the outputs transition to a predetermined state when the input power supply is not applied.

<sup>1</sup> Protected by U.S. Patents 5,952,849; 6,873,065; 6,903,578; and 7,075,329. Other patents are pending.

## TABLE OF CONTENTS

|  |    |  |    |
|--|----|--|----|
| Features .....                                     | 1  | Recommended Operating Conditions .....             | 12 |
| Applications.....                                  | 1  | Absolute Maximum Ratings .....                     | 13 |
| General Description .....                          | 1  | ESD Caution.....                                   | 13 |
| Functional Block Diagrams.....                     | 1  | Pin Configurations and Function Descriptions ..... | 14 |
| Revision History .....                             | 2  | Typical Performance Characteristics .....          | 17 |
| Specifications.....                                | 3  | Theory of Operation .....                          | 19 |
| Electrical Characteristics—5 V Operation.....      | 3  | Applications Information .....                     | 20 |
| Electrical Characteristics—3.3 V Operation .....   | 5  | PCB Layout .....                                   | 20 |
| Electrical Characteristics—2.5 V Operation .....   | 7  | Propagation Delay Related Parameters .....         | 20 |
| Electrical Characteristics—1.8 V Operation .....   | 9  | Jitter Measurement .....                           | 20 |
| Insulation and Safety Related Specifications ..... | 11 | Insulation Lifetime .....                          | 20 |
| Package Characteristics .....                      | 11 | Outline Dimensions .....                           | 22 |
| Regulatory Information.....                        | 11 | Ordering Guide .....                               | 22 |
| DIN V VDE V 0884-10 (VDE V 0884-10) Insulation     |    |  |    |
| Characteristics .....                              | 12 |  |    |

## REVISION HISTORY

### 7/2019—Rev. 0 to Rev. A

Changes to Table 11..... 11

### 8/2016—Revision 0: Initial Version

## SPECIFICATIONS

## ELECTRICAL CHARACTERISTICS—5 V OPERATION

All typical specifications are at  $T_A = 25^\circ\text{C}$ ,  $V_{DD1} = V_{DD2} = 5\text{ V}$ . Minimum/maximum specifications apply over the entire recommended operation range of  $4.5\text{ V} \leq V_{DD1} \leq 5.5\text{ V}$ ,  $4.5\text{ V} \leq V_{DD2} \leq 5.5\text{ V}$ , and  $-40^\circ\text{C} \leq T_A \leq +125^\circ\text{C}$ , unless otherwise noted. Switching specifications are tested with  $C_L = 15\text{ pF}$  and CMOS signal levels, unless otherwise noted. Supply currents are specified with 50% duty cycle signals.

Table 1.

| Parameter                 | Symbol                | Min                  | Typ             | Max                  | Unit          | Test Conditions/Comments   |
|---------------------------|-----------------------|----------------------|-----------------|----------------------|---------------|--|
| SWITCHING SPECIFICATIONS  |                       |                      |                 |                      |               |  |
| Pulse Width               | PW                    | 6.6                  |                 |                      | ns            | Within pulse width distortion (PWD) limit                        |
| Data Rate <sup>1</sup>    |                       | 150                  |                 |                      | Mbps          | Within PWD limit   |
| Propagation Delay         | $t_{PHL}$ , $t_{PLH}$ | 4.8                  | 7.2             | 13                   | ns            | 50% input to 50% output  |
| Pulse Width Distortion    | PWD                   |                      | 0.5             | 4.5                  | ns            | $ t_{PLH} - t_{PHL} $  |
| Change vs. Temperature    |                       |                      | 1.5             |                      | ps/°C         |  |
| Propagation Delay Skew    | $t_{PSK}$             |                      |                 | 6.1                  | ns            | Between any two units at the same temperature, voltage, and load |
| Channel Matching          |                       |                      |                 |                      |               |  |
| Codirectional             | $t_{PSKCD}$           |                      | 0.5             | 4.0                  | ns            |  |
| Opposing Direction        | $t_{PSKOD}$           |                      | 0.5             | 4.5                  | ns            |  |
| Jitter                    |                       |                      | 490             |                      | ps p-p        | See the Jitter Measurement section                               |
|                           |                       |                      | 70              |                      | ps rms        | See the Jitter Measurement section                               |
| DC SPECIFICATIONS         |                       |                      |                 |                      |               |  |
| Input Threshold Voltage   |                       |                      |                 |                      |               |  |
| Logic High                | $V_{IH}$              | $0.7 \times V_{DDx}$ |                 |                      | V             |  |
| Logic Low                 | $V_{IL}$              |                      |                 | $0.3 \times V_{DDx}$ | V             |  |
| Output Voltage            |                       |                      |                 |                      |               |  |
| Logic High                | $V_{OH}$              | $V_{DDx} - 0.1$      | $V_{DDx}$       |                      | V             | $I_{Ox}^2 = -20\text{ }\mu\text{A}$ , $V_{Ix} = V_{IxH}^3$       |
|                           |                       | $V_{DDx} - 0.4$      | $V_{DDx} - 0.2$ |                      | V             | $I_{Ox}^2 = -4\text{ mA}$ , $V_{Ix} = V_{IxH}^3$                 |
| Logic Low                 | $V_{OL}$              |                      | 0.0             | 0.1                  | V             | $I_{Ox}^2 = 20\text{ }\mu\text{A}$ , $V_{Ix} = V_{IxL}^4$        |
|                           |                       |                      | 0.2             | 0.4                  | V             | $I_{Ox}^2 = 4\text{ mA}$ , $V_{Ix} = V_{IxL}^4$                  |
| Input Current per Channel | $I_I$                 | -10                  | +0.01           | +10                  | $\mu\text{A}$ | $0\text{ V} \leq V_{Ix} \leq V_{DDx}$                            |
| Quiescent Supply Current  |                       |                      |                 |                      |               |  |
| ADuM150N                  |                       |                      |                 |                      |               |  |
|                           | $I_{DD1(Q)}$          |                      | 2.54            | 3.70                 | mA            | $V_I^5 = 0$ (N0), 1 (N1) <sup>6</sup>                            |
|                           | $I_{DD2(Q)}$          |                      | 3.34            | 4.56                 | mA            | $V_I^5 = 0$ (N0), 1 (N1) <sup>6</sup>                            |
|                           | $I_{DD1(Q)}$          |                      | 16.8            | 27.5                 | mA            | $V_I^5 = 1$ (N0), 0 (N1) <sup>6</sup>                            |
|                           | $I_{DD2(Q)}$          |                      | 3.57            | 4.90                 | mA            | $V_I^5 = 1$ (N0), 0 (N1) <sup>6</sup>                            |
| ADuM151N                  |                       |                      |                 |                      |               |  |
|                           | $I_{DD1(Q)}$          |                      | 2.79            | 4.09                 | mA            | $V_I^5 = 0$ (N0), 1 (N1) <sup>6</sup>                            |
|                           | $I_{DD2(Q)}$          |                      | 3.20            | 4.22                 | mA            | $V_I^5 = 0$ (N0), 1 (N1) <sup>6</sup>                            |
|                           | $I_{DD1(Q)}$          |                      | 14.2            | 23                   | mA            | $V_I^5 = 1$ (N0), 0 (N1) <sup>6</sup>                            |
|                           | $I_{DD2(Q)}$          |                      | 7.08            | 11.1                 | mA            | $V_I^5 = 1$ (N0), 0 (N1) <sup>6</sup>                            |
| ADuM152N                  |                       |                      |                 |                      |               |  |
|                           | $I_{DD1(Q)}$          |                      | 2.91            | 4.11                 | mA            | $V_I^5 = 0$ (N0), 1 (N1) <sup>6</sup>                            |
|                           | $I_{DD2(Q)}$          |                      | 2.95            | 4.15                 | mA            | $V_I^5 = 0$ (N0), 1 (N1) <sup>6</sup>                            |
|                           | $I_{DD1(Q)}$          |                      | 11.1            | 19.5                 | mA            | $V_I^5 = 1$ (N0), 0 (N1) <sup>6</sup>                            |
|                           | $I_{DD2(Q)}$          |                      | 10.5            | 16.7                 | mA            | $V_I^5 = 1$ (N0), 0 (N1) <sup>6</sup>                            |
| Dynamic Supply Current    |                       |                      |                 |                      |               | Inputs switching, 50% duty cycle                                 |
| Dynamic Input             | $I_{DDI(D)}$          |                      | 0.01            |                      | mA/Mbps       |  |
| Dynamic Output            | $I_{DDO(D)}$          |                      | 0.02            |                      | mA/Mbps       |  |

| Parameter                                   | Symbol       | Min | Typ | Max | Unit        | Test Conditions/Comments  |
|---|--------------|-----|-----|-----|-------------|---|
| Undervoltage Lockout                        | UVLO         |     |     |     |             |   |
| Positive $V_{DDx}$ Threshold                | $V_{DDxUV+}$ |     | 1.6 |     | V           |   |
| Negative $V_{DDx}$ Threshold                | $V_{DDxUV-}$ |     | 1.5 |     | V           |   |
| $V_{DDx}$ Hysteresis                        | $V_{DDxUVH}$ |     | 0.1 |     | V           |   |
| AC SPECIFICATIONS                           |              |     |     |     |             |   |
| Output Rise/Fall Time                       | $t_r/t_f$    |     | 2.5 |     | ns          | 10% to 90%  |
| Common-Mode Transient Immunity <sup>7</sup> | $ CM_H $     | 75  | 100 |     | kV/ $\mu$ s | $V_{ix} = V_{DDx}$ , $V_{CM} = 1000$ V, transient magnitude = 800 V |
|   | $ CM_L $     | 75  | 100 |     | kV/ $\mu$ s | $V_{ix} = 0$ V, $V_{CM} = 1000$ V, transient magnitude = 800 V      |

<sup>1</sup> 150 Mbps is the highest data rate that can be guaranteed, although higher data rates are possible.

<sup>2</sup>  $I_{Ox}$  is the Channel x output current, where x = A, B, C, D, or E.

<sup>3</sup>  $V_{IH}$  is the input side logic high.

<sup>4</sup>  $V_{IL}$  is the input side logic low.

<sup>5</sup>  $V_i$  is the voltage input.

<sup>6</sup> N0 refers to the ADuM150N0/ADuM151N0/ADuM152N0 models. N1 refers to the ADuM150N1/ADuM151N1/ADuM152N1 models. See the Ordering Guide section.

<sup>7</sup>  $|CM_H|$  is the maximum common-mode voltage slew rate that can be sustained while maintaining the voltage output ( $V_O$ ) > 0.8  $V_{DDx}$ .  $|CM_L|$  is the maximum common-mode voltage slew rate that can be sustained while maintaining  $V_O > 0.8$  V. The common-mode voltage slew rates apply to both rising and falling common-mode voltage edges.

Table 2. Total Supply Current vs. Data Throughput

| Parameter             | Symbol    | 1 Mbps |      |      | 25 Mbps |      |      | 100 Mbps |      |      | Unit |
|-----------------------|-----------|--------|------|------|---------|------|------|----------|------|------|------|
|                       |           | Min    | Typ  | Max  | Min     | Typ  | Max  | Min      | Typ  | Max  |      |
| SUPPLY CURRENT        |           |        |      |      |         |      |      |          |      |      |      |
| ADuM150N              |           |        |      |      |         |      |      |          |      |      |      |
| Supply Current Side 1 | $I_{DD1}$ |        | 9.63 | 14.6 |         | 10.9 | 17.1 |          | 16.0 | 24.0 | mA   |
| Supply Current Side 2 | $I_{DD2}$ |        | 3.61 | 5.61 |         | 5.36 | 8.50 |          | 11.1 | 19.0 | mA   |
| ADuM151N              |           |        |      |      |         |      |      |          |      |      |      |
| Supply Current Side 1 | $I_{DD1}$ |        | 8.51 | 13.7 |         | 9.85 | 16.1 |          | 15.0 | 23.3 | mA   |
| Supply Current Side 2 | $I_{DD2}$ |        | 5.28 | 8.95 |         | 6.89 | 11.5 |          | 12.3 | 20.0 | mA   |
| ADuM152N              |           |        |      |      |         |      |      |          |      |      |      |
| Supply Current Side 1 | $I_{DD1}$ |        | 7.08 | 11.6 |         | 8.56 | 13.9 |          | 13.7 | 20.4 | mA   |
| Supply Current Side 2 | $I_{DD2}$ |        | 6.83 | 10.5 |         | 8.35 | 12.8 |          | 13.4 | 20.6 | mA   |

**ELECTRICAL CHARACTERISTICS—3.3 V OPERATION**

All typical specifications are at  $T_A = 25^\circ\text{C}$ ,  $V_{DD1} = V_{DD2} = 3.3\text{ V}$ . Minimum/maximum specifications apply over the entire recommended operation range:  $3.0\text{ V} \leq V_{DD1} \leq 3.6\text{ V}$ ,  $3.0\text{ V} \leq V_{DD2} \leq 3.6\text{ V}$ , and  $-40^\circ\text{C} \leq T_A \leq +125^\circ\text{C}$ , unless otherwise noted. Switching specifications are tested with  $C_L = 15\text{ pF}$  and CMOS signal levels, unless otherwise noted. Supply currents are specified with 50% duty cycle signals.

**Table 3.**

| Parameter                       | Symbol                | Min                  | Typ             | Max                  | Unit                 | Test Conditions/Comments   |
|---------------------------------|-----------------------|----------------------|-----------------|----------------------|----------------------|--|
| <b>SWITCHING SPECIFICATIONS</b> |                       |                      |                 |                      |                      |  |
| Pulse Width                     | PW                    | 6.6                  |                 |                      | ns                   | Within PWD limit   |
| Data Rate <sup>1</sup>          |                       | 150                  |                 |                      | Mbps                 | Within PWD limit   |
| Propagation Delay               | $t_{PHL}$ , $t_{PLH}$ | 4.8                  | 6.8             | 14                   | ns                   | 50% input to 50% output  |
| Pulse Width Distortion          | PWD                   |                      | 0.7             | 4.5                  | ns                   | $ t_{PLH} - t_{PHL} $  |
| Change vs. Temperature          |                       |                      | 1.5             |                      | ps/ $^\circ\text{C}$ |  |
| Propagation Delay Skew          | $t_{PSK}$             |                      |                 | 7.5                  | ns                   | Between any two units at the same temperature, voltage, and load |
| Channel Matching                |                       |                      |                 |                      |                      |  |
| Codirectional                   | $t_{PSKCD}$           |                      | 0.7             | 4.0                  | ns                   |  |
| Opposing Direction              | $t_{PSKOD}$           |                      | 0.7             | 4.5                  | ns                   |  |
| Jitter                          |                       |                      | 580             |                      | ps p-p               | See the Jitter Measurement section                               |
|                                 |                       |                      | 120             |                      | ps rms               | See the Jitter Measurement section                               |
| <b>DC SPECIFICATIONS</b>        |                       |                      |                 |                      |                      |  |
| Input Threshold Voltage         |                       |                      |                 |                      |                      |  |
| Logic High                      | $V_{IH}$              | $0.7 \times V_{DDx}$ |                 |                      | V                    |  |
| Logic Low                       | $V_{IL}$              |                      |                 | $0.3 \times V_{DDx}$ | V                    |  |
| Output Voltage                  |                       |                      |                 |                      |                      |  |
| Logic High                      | $V_{OH}$              | $V_{DDx} - 0.1$      | $V_{DDx}$       |                      | V                    | $I_{Ox}^2 = -20\ \mu\text{A}$ , $V_{Ix} = V_{IxH}^3$             |
|                                 |                       | $V_{DDx} - 0.4$      | $V_{DDx} - 0.2$ |                      | V                    | $I_{Ox}^2 = -2\ \text{mA}$ , $V_{Ix} = V_{IxH}^3$                |
| Logic Low                       | $V_{OL}$              |                      | 0.0             | 0.1                  | V                    | $I_{Ox}^2 = 20\ \mu\text{A}$ , $V_{Ix} = V_{IxL}^4$              |
|                                 |                       |                      | 0.2             | 0.4                  | V                    | $I_{Ox}^2 = 2\ \text{mA}$ , $V_{Ix} = V_{IxL}^4$                 |
| Input Current per Channel       | $I_i$                 | -10                  | +0.01           | +10                  | $\mu\text{A}$        | $0\text{ V} \leq V_{Ix} \leq V_{DDx}$                            |
| Quiescent Supply Current        |                       |                      |                 |                      |                      |  |
| ADuM150N                        |                       |                      |                 |                      |                      |  |
|                                 | $I_{DD1(Q)}$          |                      | 2.36            | 3.52                 | mA                   | $V_i^5 = 0\text{ (N0)}, 1\text{ (N1)}^6$                         |
|                                 | $I_{DD2(Q)}$          |                      | 3.20            | 4.42                 | mA                   | $V_i^5 = 0\text{ (N0)}, 1\text{ (N1)}^6$                         |
|                                 | $I_{DD1(Q)}$          |                      | 16.5            | 27.2                 | mA                   | $V_i^5 = 1\text{ (N0)}, 0\text{ (N1)}^6$                         |
|                                 | $I_{DD2(Q)}$          |                      | 3.43            | 4.76                 | mA                   | $V_i^5 = 1\text{ (N0)}, 0\text{ (N1)}^6$                         |
| ADuM151N                        |                       |                      |                 |                      |                      |  |
|                                 | $I_{DD1(Q)}$          |                      | 2.61            | 3.91                 | mA                   | $V_i^5 = 0\text{ (N0)}, 1\text{ (N1)}^6$                         |
|                                 | $I_{DD2(Q)}$          |                      | 3.05            | 4.07                 | mA                   | $V_i^5 = 0\text{ (N0)}, 1\text{ (N1)}^6$                         |
|                                 | $I_{DD1(Q)}$          |                      | 14.0            | 22.8                 | mA                   | $V_i^5 = 1\text{ (N0)}, 0\text{ (N1)}^6$                         |
|                                 | $I_{DD2(Q)}$          |                      | 6.91            | 10.9                 | mA                   | $V_i^5 = 1\text{ (N0)}, 0\text{ (N1)}^6$                         |
| ADuM152N                        |                       |                      |                 |                      |                      |  |
|                                 | $I_{DD1(Q)}$          |                      | 2.74            | 3.94                 | mA                   | $V_i^5 = 0\text{ (N0)}, 1\text{ (N1)}^6$                         |
|                                 | $I_{DD2(Q)}$          |                      | 2.79            | 3.99                 | mA                   | $V_i^5 = 0\text{ (N0)}, 1\text{ (N1)}^6$                         |
|                                 | $I_{DD1(Q)}$          |                      | 10.9            | 19.3                 | mA                   | $V_i^5 = 1\text{ (N0)}, 0\text{ (N1)}^6$                         |
|                                 | $I_{DD2(Q)}$          |                      | 10.3            | 16.5                 | mA                   | $V_i^5 = 1\text{ (N0)}, 0\text{ (N1)}^6$                         |
| Dynamic Supply Current          |                       |                      |                 |                      |                      | Inputs switching, 50% duty cycle                                 |
| Dynamic Input                   | $I_{DDI(D)}$          |                      | 0.01            |                      | mA/Mbps              |  |
| Dynamic Output                  | $I_{DDO(D)}$          |                      | 0.01            |                      | mA/Mbps              |  |
| Undervoltage Lockout            | UVLO                  |                      |                 |                      |                      |  |
| Positive $V_{DDx}$ Threshold    | $V_{DDxUV+}$          |                      | 1.6             |                      | V                    |  |
| Negative $V_{DDx}$ Threshold    | $V_{DDxUV-}$          |                      | 1.5             |                      | V                    |  |
| $V_{DDx}$ Hysteresis            | $V_{DDxUVH}$          |                      | 0.1             |                      | V                    |  |

| Parameter                                   | Symbol    | Min | Typ | Max | Unit        | Test Conditions/Comments   |
|---|-----------|-----|-----|-----|-------------|--|
| AC SPECIFICATIONS                           |           |     |     |     |             |  |
| Output Rise/Fall Time                       | $t_R/t_F$ |     | 2.5 |     | ns          | 10% to 90%   |
| Common-Mode Transient Immunity <sup>7</sup> | $ CM_H $  | 75  | 100 |     | kV/ $\mu$ s | $V_{IX} = V_{DDX}$ , $V_{CM} = 1000$ V,<br>transient magnitude = 800 V |
|   | $ CM_L $  | 75  | 100 |     | kV/ $\mu$ s | $V_{IX} = 0$ V, $V_{CM} = 1000$ V,<br>transient magnitude = 800 V      |

<sup>1</sup> 150 Mbps is the highest data rate that can be guaranteed, although higher data rates are possible.

<sup>2</sup>  $I_{OX}$  is the Channel x output current, where x = A, B, C, D, or E.

<sup>3</sup>  $V_{IH}$  is the input side logic high.

<sup>4</sup>  $V_{IL}$  is the input side logic low.

<sup>5</sup>  $V_i$  is the voltage input.

<sup>6</sup> N0 refers to the ADuM150N0/ADuM151N0/ADuM152N0 models. N1 refers to the ADuM150N1/ADuM151N1/ADuM152N1 models. See the Ordering Guide section.

<sup>7</sup>  $|CM_H|$  is the maximum common-mode voltage slew rate that can be sustained while maintaining the voltage output ( $V_O$ ) > 0.8  $V_{DDX}$ .  $|CM_L|$  is the maximum common-mode voltage slew rate that can be sustained while maintaining  $V_O > 0.8$  V. The common-mode voltage slew rates apply to both rising and falling common-mode voltage edges.

Table 4. Total Supply Current vs. Data Throughput

| Parameter             | Symbol    | 1 Mbps |      |      | 25 Mbps |      |      | 100 Mbps |      |      | Unit |
|-----------------------|-----------|--------|------|------|---------|------|------|----------|------|------|------|
|                       |           | Min    | Typ  | Max  | Min     | Typ  | Max  | Min      | Typ  | Max  |      |
| SUPPLY CURRENT        |           |        |      |      |         |      |      |          |      |      |      |
| ADuM150N              |           |        |      |      |         |      |      |          |      |      |      |
| Supply Current Side 1 | $I_{DD1}$ |        | 9.36 | 14.3 |         | 10.4 | 16.6 |          | 14.6 | 22.6 | mA   |
| Supply Current Side 2 | $I_{DD2}$ |        | 3.45 | 5.45 |         | 5.03 | 8.23 |          | 10.2 | 18.1 | mA   |
| ADuM151N              |           |        |      |      |         |      |      |          |      |      |      |
| Supply Current Side 1 | $I_{DD1}$ |        | 8.26 | 13.5 |         | 9.41 | 15.7 |          | 13.9 | 22.2 | mA   |
| Supply Current Side 2 | $I_{DD2}$ |        | 5.09 | 8.76 |         | 6.55 | 11.2 |          | 11.4 | 19.1 | mA   |
| ADuM152N              |           |        |      |      |         |      |      |          |      |      |      |
| Supply Current Side 1 | $I_{DD1}$ |        | 6.84 | 11.3 |         | 8.12 | 13.5 |          | 12.7 | 19.4 | mA   |
| Supply Current Side 2 | $I_{DD2}$ |        | 6.60 | 10.3 |         | 7.94 | 12.4 |          | 12.6 | 19.8 | mA   |

**ELECTRICAL CHARACTERISTICS—2.5 V OPERATION**

All typical specifications are at  $T_A = 25^\circ\text{C}$ ,  $V_{DD1} = V_{DD2} = 2.5\text{ V}$ . Minimum/maximum specifications apply over the entire recommended operation range:  $2.25\text{ V} \leq V_{DD1} \leq 2.75\text{ V}$ ,  $2.25\text{ V} \leq V_{DD2} \leq 2.75\text{ V}$ ,  $-40^\circ\text{C} \leq T_A \leq +125^\circ\text{C}$ , unless otherwise noted. Switching specifications are tested with  $C_L = 15\text{ pF}$  and CMOS signal levels, unless otherwise noted. Supply currents are specified with 50% duty cycle signals.

**Table 5.**

| Parameter                       | Symbol                | Min                  | Typ             | Max                  | Unit                 | Test Conditions/Comments                                     |
|---------------------------------|-----------------------|----------------------|-----------------|----------------------|----------------------|--|
| <b>SWITCHING SPECIFICATIONS</b> |                       |                      |                 |                      |                      |  |
| Pulse Width                     | PW                    | 6.6                  |                 |                      | ns                   | Within PWD limit   |
| Data Rate <sup>1</sup>          |                       | 150                  |                 |                      | Mbps                 | Within PWD limit   |
| Propagation Delay               | $t_{PHL}$ , $t_{PLH}$ | 5.0                  | 7.0             | 14                   | ns                   | 50% input to 50% output                                      |
| Pulse Width Distortion          | PWD                   |                      | 0.7             | 5.0                  | ns                   | $ t_{PLH} - t_{PHL} $  |
| Change vs. Temperature          |                       |                      | 1.5             |                      | ps/ $^\circ\text{C}$ |  |
| Propagation Delay Skew          | $t_{PSK}$             |                      |                 | 6.8                  | ns                   | Between any two units at the same temperature, voltage, load |
| Channel Matching                |                       |                      |                 |                      |                      |  |
| Codirectional                   | $t_{PSKCD}$           |                      | 0.7             | 5.0                  | ns                   |  |
| Opposing Direction              | $t_{PSKOD}$           |                      | 0.7             | 5.0                  | ns                   |  |
| Jitter                          |                       |                      | 800             |                      | ps p-p               | See the Jitter Measurement section                           |
|                                 |                       |                      | 190             |                      | ps rms               | See the Jitter Measurement section                           |
| <b>DC SPECIFICATIONS</b>        |                       |                      |                 |                      |                      |  |
| Input Threshold Voltage         |                       |                      |                 |                      |                      |  |
| Logic High                      | $V_{IH}$              | $0.7 \times V_{DDx}$ |                 |                      | V                    |  |
| Logic Low                       | $V_{IL}$              |                      |                 | $0.3 \times V_{DDx}$ | V                    |  |
| Output Voltage                  |                       |                      |                 |                      |                      |  |
| Logic High                      | $V_{OH}$              | $V_{DDx} - 0.1$      | $V_{DDx}$       |                      | V                    | $I_{Ox}^2 = -20\ \mu\text{A}$ , $V_{Ix} = V_{IxH}^3$         |
|                                 |                       | $V_{DDx} - 0.4$      | $V_{DDx} - 0.2$ |                      | V                    | $I_{Ox}^2 = -2\ \text{mA}$ , $V_{Ix} = V_{IxH}^3$            |
| Logic Low                       | $V_{OL}$              |                      | 0.0             | 0.1                  | V                    | $I_{Ox}^2 = 20\ \mu\text{A}$ , $V_{Ix} = V_{IxL}^4$          |
|                                 |                       |                      | 0.2             | 0.4                  | V                    | $I_{Ox}^2 = 2\ \text{mA}$ , $V_{Ix} = V_{IxL}^4$             |
| Input Current per Channel       | $I_I$                 | -10                  | +0.01           | +10                  | $\mu\text{A}$        | $0\text{ V} \leq V_{Ix} \leq V_{DDx}$                        |
| Quiescent Supply Current        |                       |                      |                 |                      |                      |  |
| ADuM150N                        |                       |                      |                 |                      |                      |  |
|                                 | $I_{DD1(Q)}$          |                      | 2.28            | 3.44                 | mA                   | $V_I^5 = 0\ (N0), 1\ (N1)^6$                                 |
|                                 | $I_{DD2(Q)}$          |                      | 3.13            | 4.35                 | mA                   | $V_I^5 = 0\ (N0), 1\ (N1)^6$                                 |
|                                 | $I_{DD1(Q)}$          |                      | 16.4            | 27.1                 | mA                   | $V_I^5 = 1\ (N0), 0\ (N1)^6$                                 |
|                                 | $I_{DD2(Q)}$          |                      | 3.34            | 4.67                 | mA                   | $V_I^5 = 1\ (N0), 0\ (N1)^6$                                 |
| ADuM151N                        |                       |                      |                 |                      |                      |  |
|                                 | $I_{DD1(Q)}$          |                      | 2.52            | 3.82                 | mA                   | $V_I^5 = 0\ (N0), 1\ (N1)^6$                                 |
|                                 | $I_{DD2(Q)}$          |                      | 2.97            | 3.99                 | mA                   | $V_I^5 = 0\ (N0), 1\ (N1)^6$                                 |
|                                 | $I_{DD1(Q)}$          |                      | 13.9            | 22.7                 | mA                   | $V_I^5 = 1\ (N0), 0\ (N1)^6$                                 |
|                                 | $I_{DD2(Q)}$          |                      | 6.83            | 10.8                 | mA                   | $V_I^5 = 1\ (N0), 0\ (N1)^6$                                 |
| ADuM152N                        |                       |                      |                 |                      |                      |  |
|                                 | $I_{DD1(Q)}$          |                      | 2.66            | 3.86                 | mA                   | $V_I^5 = 0\ (N0), 1\ (N1)^6$                                 |
|                                 | $I_{DD2(Q)}$          |                      | 2.71            | 3.91                 | mA                   | $V_I^5 = 0\ (N0), 1\ (N1)^6$                                 |
|                                 | $I_{DD1(Q)}$          |                      | 10.8            | 19.2                 | mA                   | $V_I^5 = 1\ (N0), 0\ (N1)^6$                                 |
|                                 | $I_{DD2(Q)}$          |                      | 10.2            | 16.4                 | mA                   | $V_I^5 = 1\ (N0), 0\ (N1)^6$                                 |
| Dynamic Supply Current          |                       |                      |                 |                      |                      | Inputs switching, 50% duty cycle                             |
| Dynamic Input                   | $I_{DDI(D)}$          |                      | 0.01            |                      | mA/Mbps              |  |
| Dynamic Output                  | $I_{DDO(D)}$          |                      | 0.01            |                      | mA/Mbps              |  |
| Undervoltage Lockout            |                       |                      |                 |                      |                      |  |
| Positive $V_{DDx}$ Threshold    | $V_{DDxUV+}$          |                      | 1.6             |                      | V                    |  |
| Negative $V_{DDx}$ Threshold    | $V_{DDxUV-}$          |                      | 1.5             |                      | V                    |  |
| $V_{DDx}$ Hysteresis            | $V_{DDxUVH}$          |                      | 0.1             |                      | V                    |  |

| Parameter                                   | Symbol    | Min | Typ | Max | Unit        | Test Conditions/Comments   |
|---|-----------|-----|-----|-----|-------------|--|
| AC SPECIFICATIONS                           |           |     |     |     |             |  |
| Output Rise/Fall Time                       | $t_R/t_F$ |     | 2.5 |     | ns          | 10% to 90%   |
| Common-Mode Transient Immunity <sup>7</sup> | $ CM_H $  | 75  | 100 |     | kV/ $\mu$ s | $V_{IX} = V_{DDX}$ , $V_{CM} = 1000$ V,<br>transient magnitude = 800 V |
|   | $ CM_L $  | 75  | 100 |     | kV/ $\mu$ s | $V_{IX} = 0$ V, $V_{CM} = 1000$ V,<br>transient magnitude = 800 V      |

<sup>1</sup> 150 Mbps is the highest data rate that can be guaranteed, although higher data rates are possible.

<sup>2</sup>  $I_{OX}$  is the Channel x output current, where x = A, B, C, D, or E.

<sup>3</sup>  $V_{IH}$  is the input side logic high.

<sup>4</sup>  $V_{IL}$  is the input side logic low.

<sup>5</sup>  $V_i$  is the voltage input.

<sup>6</sup> N0 refers to the ADuM150N0/ADuM151N0/ADuM152N0 models. N1 refers to the ADuM150N1/ADuM151N1/ADuM152N1 models. See the Ordering Guide section.

<sup>7</sup>  $|CM_H|$  is the maximum common-mode voltage slew rate that can be sustained while maintaining the voltage output ( $V_O$ ) > 0.8  $V_{DDX}$ .  $|CM_L|$  is the maximum common-mode voltage slew rate that can be sustained while maintaining  $V_O$  > 0.8 V. The common-mode voltage slew rates apply to both rising and falling common-mode voltage edges.

**Table 6. Total Supply Current vs. Data Throughput**

| Parameter             | Symbol    | 1 Mbps |      |      | 25 Mbps |      |      | 100 Mbps |      |      | Unit |
|-----------------------|-----------|--------|------|------|---------|------|------|----------|------|------|------|
|                       |           | Min    | Typ  | Max  | Min     | Typ  | Max  | Min      | Typ  | Max  |      |
| SUPPLY CURRENT        |           |        |      |      |         |      |      |          |      |      |      |
| ADuM150N              |           |        |      |      |         |      |      |          |      |      |      |
| Supply Current Side 1 | $I_{DD1}$ |        | 9.25 | 14.2 |         | 10.2 | 16.4 |          | 14.0 | 22.0 | mA   |
| Supply Current Side 2 | $I_{DD2}$ |        | 3.35 | 5.35 |         | 4.58 | 7.78 |          | 8.61 | 16.5 | mA   |
| ADuM151N              |           |        |      |      |         |      |      |          |      |      |      |
| Supply Current Side 1 | $I_{DD1}$ |        | 8.14 | 13.4 |         | 9.14 | 15.4 |          | 13.1 | 21.4 | mA   |
| Supply Current Side 2 | $I_{DD2}$ |        | 4.98 | 8.65 |         | 6.14 | 10.8 |          | 10.1 | 17.8 | mA   |
| ADuM152N              |           |        |      |      |         |      |      |          |      |      |      |
| Supply Current Side 1 | $I_{DD1}$ |        | 6.74 | 11.2 |         | 7.80 | 13.2 |          | 11.8 | 18.5 | mA   |
| Supply Current Side 2 | $I_{DD2}$ |        | 6.48 | 10.2 |         | 7.56 | 12.0 |          | 11.5 | 18.7 | mA   |



**ELECTRICAL CHARACTERISTICS—1.8 V OPERATION**

All typical specifications are at  $T_A = 25^\circ\text{C}$ ,  $V_{DD1} = V_{DD2} = 1.8\text{ V}$ . Minimum/maximum specifications apply over the entire recommended operation range:  $1.7\text{ V} \leq V_{DD1} \leq 1.9\text{ V}$ ,  $1.7\text{ V} \leq V_{DD2} \leq 1.9\text{ V}$ , and  $-40^\circ\text{C} \leq T_A \leq +125^\circ\text{C}$ , unless otherwise noted. Switching specifications are tested with  $C_L = 15\text{ pF}$  and CMOS signal levels, unless otherwise noted. Supply currents are specified with 50% duty cycle signals.

Table 7.

| Parameter                       | Symbol                | Min                  | Typ             | Max                  | Unit          | Test Conditions/Comments   |
|---------------------------------|-----------------------|----------------------|-----------------|----------------------|---------------|--|
| <b>SWITCHING SPECIFICATIONS</b> |                       |                      |                 |                      |               |  |
| Pulse Width                     | PW                    | 6.6                  |                 |                      | ns            | Within PWD limit   |
| Data Rate <sup>1</sup>          |                       | 150                  |                 |                      | Mbps          | Within PWD limit   |
| Propagation Delay               | $t_{PHL}$ , $t_{PLH}$ | 5.8                  | 8.7             | 15                   | ns            | 50% input to 50% output  |
| Pulse Width Distortion          | PWD                   |                      | 0.7             | 5.0                  | ns            | $ t_{PLH} - t_{PHL} $  |
| Change vs. Temperature          |                       |                      | 1.5             |                      | ps/°C         |  |
| Propagation Delay Skew          | $t_{PSK}$             |                      |                 | 7.0                  | ns            | Between any two units at the same temperature, voltage, and load |
| Channel Matching                |                       |                      |                 |                      |               |  |
| Codirectional                   | $t_{PSKCD}$           |                      | 0.7             | 5.0                  | ns            |  |
| Opposing Direction              | $t_{PSKOD}$           |                      | 0.7             | 5.0                  | ns            |  |
| Jitter                          |                       |                      | 470             |                      | ps p-p        | See the Jitter Measurement section                               |
|                                 |                       |                      | 70              |                      | ps rms        | See the Jitter Measurement section                               |
| <b>DC SPECIFICATIONS</b>        |                       |                      |                 |                      |               |  |
| Input Threshold Voltage         |                       |                      |                 |                      |               |  |
| Logic High                      | $V_{IH}$              | $0.7 \times V_{DDx}$ |                 |                      | V             |  |
| Logic Low                       | $V_{IL}$              |                      |                 | $0.3 \times V_{DDx}$ | V             |  |
| Output Voltage                  |                       |                      |                 |                      |               |  |
| Logic High                      | $V_{OH}$              | $V_{DDx} - 0.1$      | $V_{DDx}$       |                      | V             | $I_{Ox}^2 = -20\ \mu\text{A}$ , $V_{Ix} = V_{IxH}^3$             |
|                                 |                       | $V_{DDx} - 0.4$      | $V_{DDx} - 0.2$ |                      | V             | $I_{Ox}^2 = -2\ \text{mA}$ , $V_{Ix} = V_{IxH}^3$                |
| Logic Low                       | $V_{OL}$              |                      | 0.0             | 0.1                  | V             | $I_{Ox}^2 = 20\ \mu\text{A}$ , $V_{Ix} = V_{IxL}^4$              |
|                                 |                       |                      | 0.2             | 0.4                  | V             | $I_{Ox}^2 = 2\ \text{mA}$ , $V_{Ix} = V_{IxL}^4$                 |
| Input Current per Channel       | $I_i$                 | -10                  | +0.01           | +10                  | $\mu\text{A}$ | $0\text{ V} \leq V_{Ix} \leq V_{DDx}$                            |
| Quiescent Supply Current        |                       |                      |                 |                      |               |  |
| ADuM150N                        |                       |                      |                 |                      |               |  |
|                                 | $I_{DD1(Q)}$          |                      | 2.19            | 3.35                 | mA            | $V_I^5 = 0$ (N0), 1 (N1) <sup>6</sup>                            |
|                                 | $I_{DD2(Q)}$          |                      | 3.07            | 4.29                 | mA            | $V_I^5 = 0$ (N0), 1 (N1) <sup>6</sup>                            |
|                                 | $I_{DD1(Q)}$          |                      | 16.3            | 27.0                 | mA            | $V_I^5 = 1$ (N0), 0 (N1) <sup>6</sup>                            |
|                                 | $I_{DD2(Q)}$          |                      | 3.28            | 4.61                 | mA            | $V_I^5 = 1$ (N0), 0 (N1) <sup>6</sup>                            |
| ADuM151N                        |                       |                      |                 |                      |               |  |
|                                 | $I_{DD1(Q)}$          |                      | 2.44            | 3.74                 | mA            | $V_I^5 = 0$ (N0), 1 (N1) <sup>6</sup>                            |
|                                 | $I_{DD2(Q)}$          |                      | 2.91            | 3.93                 | mA            | $V_I^5 = 0$ (N0), 1 (N1) <sup>6</sup>                            |
|                                 | $I_{DD1(Q)}$          |                      | 13.7            | 22.5                 | mA            | $V_I^5 = 1$ (N0), 0 (N1) <sup>6</sup>                            |
|                                 | $I_{DD2(Q)}$          |                      | 6.75            | 10.7                 | mA            | $V_I^5 = 1$ (N0), 0 (N1) <sup>6</sup>                            |
| ADuM152N                        |                       |                      |                 |                      |               |  |
|                                 | $I_{DD1(Q)}$          |                      | 2.58            | 3.78                 | mA            | $V_I^5 = 0$ (N0), 1 (N1) <sup>6</sup>                            |
|                                 | $I_{DD2(Q)}$          |                      | 2.64            | 3.84                 | mA            | $V_I^5 = 0$ (N0), 1 (N1) <sup>6</sup>                            |
|                                 | $I_{DD1(Q)}$          |                      | 10.7            | 19.1                 | mA            | $V_I^5 = 1$ (N0), 0 (N1) <sup>6</sup>                            |
|                                 | $I_{DD2(Q)}$          |                      | 10.1            | 16.3                 | mA            | $V_I^5 = 1$ (N0), 0 (N1) <sup>6</sup>                            |
| Dynamic Supply Current          |                       |                      |                 |                      |               |  |
| Dynamic Input                   | $I_{DDI(D)}$          |                      | 0.01            |                      | mA/Mbps       | Inputs switching, 50% duty cycle                                 |
| Dynamic Output                  | $I_{DDO(D)}$          |                      | 0.01            |                      | mA/Mbps       |  |
| Undervoltage Lockout            | UVLO                  |                      |                 |                      |               |  |
| Positive $V_{DDx}$ Threshold    | $V_{DDxUV+}$          |                      | 1.6             |                      | V             |  |
| Negative $V_{DDx}$ Threshold    | $V_{DDxUV-}$          |                      | 1.5             |                      | V             |  |
| $V_{DDx}$ Hysteresis            | $V_{DDxUVH}$          |                      | 0.1             |                      | V             |  |

| Parameter                                   | Symbol    | Min | Typ | Max | Unit        | Test Conditions/Comments   |
|---|-----------|-----|-----|-----|-------------|--|
| AC SPECIFICATIONS                           |           |     |     |     |             |  |
| Output Rise/Fall Time                       | $t_R/t_F$ |     | 2.5 |     | ns          | 10% to 90%   |
| Common-Mode Transient Immunity <sup>7</sup> | $ CM_H $  | 75  | 100 |     | kV/ $\mu$ s | $V_{ix} = V_{DDx}$ , $V_{CM} = 1000$ V,<br>transient magnitude = 800 V |
|   | $ CM_L $  | 75  | 100 |     | kV/ $\mu$ s | $V_{ix} = 0$ V, $V_{CM} = 1000$ V,<br>transient magnitude = 800 V      |

<sup>1</sup> 150 Mbps is the highest data rate that can be guaranteed, although higher data rates are possible.

<sup>2</sup>  $I_{Ox}$  is the Channel x output current, where x = A, B, C, D, or E.

<sup>3</sup>  $V_{IH}$  is the input side logic high.

<sup>4</sup>  $V_{IL}$  is the input side logic low.

<sup>5</sup>  $V_i$  is the voltage input.

<sup>6</sup> N0 refers to the ADuM150N0/ADuM151N0/ADuM152N0 models. N1 refers to the ADuM150N1/ADuM151N1/ADuM152N1 models. See the Ordering Guide section.

<sup>7</sup>  $|CM_H|$  is the maximum common-mode voltage slew rate that can be sustained while maintaining the voltage output ( $V_O$ ) > 0.8  $V_{DDx}$ .  $|CM_L|$  is the maximum common-mode voltage slew rate that can be sustained while maintaining  $V_O$  > 0.8 V. The common-mode voltage slew rates apply to both rising and falling common-mode voltage edges.

Table 8. Total Supply Current vs. Data Throughput

| Parameter             | Symbol    | 1 Mbps |      |      | 25 Mbps |      |      | 100 Mbps |      |      | Unit |
|-----------------------|-----------|--------|------|------|---------|------|------|----------|------|------|------|
|                       |           | Min    | Typ  | Max  | Min     | Typ  | Max  | Min      | Typ  | Max  |      |
| SUPPLY CURRENT        |           |        |      |      |         |      |      |          |      |      |      |
| ADuM150N              |           |        |      |      |         |      |      |          |      |      |      |
| Supply Current Side 1 | $I_{DD1}$ |        | 9.07 | 14.0 |         | 10.0 | 16.2 |          | 13.8 | 21.8 | mA   |
| Supply Current Side 2 | $I_{DD2}$ |        | 3.30 | 5.30 |         | 4.55 | 7.75 |          | 8.71 | 16.4 | mA   |
| ADuM151N              |           |        |      |      |         |      |      |          |      |      |      |
| Supply Current Side 1 | $I_{DD1}$ |        | 7.99 | 13.3 |         | 8.98 | 15.3 |          | 12.8 | 21.1 | mA   |
| Supply Current Side 2 | $I_{DD2}$ |        | 4.89 | 8.56 |         | 6.06 | 10.7 |          | 10.1 | 17.8 | mA   |
| ADuM152N              |           |        |      |      |         |      |      |          |      |      |      |
| Supply Current Side 1 | $I_{DD1}$ |        | 6.62 | 11.1 |         | 7.68 | 13.1 |          | 11.6 | 18.3 | mA   |
| Supply Current Side 2 | $I_{DD2}$ |        | 6.38 | 10.1 |         | 7.45 | 11.9 |          | 11.5 | 18.7 | mA   |

**INSULATION AND SAFETY RELATED SPECIFICATIONS**

For additional information, see <http://www.analog.com/icouplersafety>.

**Table 9.**

| Parameter   | Symbol  | Value | Unit   | Test Conditions/Comments   |
|---|---------|-------|--------|--|
| Rated Dielectric Insulation Voltage   |         | 3000  | V rms  | 1-minute duration  |
| Minimum External Air Gap (Clearance)  | L (I01) | 4.0   | mm min | Measured from input terminals to output terminals, shortest distance through air   |
| Minimum External Tracking (Creepage)  | L (I02) | 4.0   | mm min | Measured from input terminals to output terminals, shortest distance path along body                                       |
| Minimum Clearance in the Plane of the Printed Circuit Board (PCB Clearance) | L (PCB) | 4.5   | mm min | Measured from input terminals to output terminals, shortest distance through air, line of sight, in the PCB mounting plane |
| Minimum Internal Gap (Internal Clearance)                                   |         | 25.5  | µm min | Minimum distance through insulation  |
| Tracking Resistance (Comparative Tracking Index)                            | CTI     | >400  | V      | DIN IEC 112/VDE 0303 Part 1  |
| Material Group  |         | II    |        | Material Group (DIN VDE 0110, 1/89, Table 1)   |

**PACKAGE CHARACTERISTICS****Table 10.**

| Parameter                                  | Symbol           | Min | Typ              | Max | Unit | Test Conditions/Comments                            |
|--|------------------|-----|------------------|-----|------|---|
| Resistance (Input to Output) <sup>1</sup>  | R <sub>I-O</sub> |     | 10 <sup>13</sup> |     | Ω    |   |
| Capacitance (Input to Output) <sup>1</sup> | C <sub>I-O</sub> |     | 2.2              |     | pF   | f = 1 MHz   |
| Input Capacitance <sup>2</sup>             | C <sub>I</sub>   |     | 4.0              |     | pF   |   |
| IC Junction to Ambient Thermal Resistance  | θ <sub>JA</sub>  |     | 75               |     | °C/W | Thermocouple located at center of package underside |

<sup>1</sup> The device is considered a 2-terminal device: Pin 1 through Pin 8 are shorted together, and Pin 9 through Pin 16 are shorted together.

<sup>2</sup> Input capacitance is from any input data pin to ground.

**REGULATORY INFORMATION**

See Table 15 and the Insulation Lifetime section for details regarding recommended maximum working voltages for specific cross-isolation waveforms and insulation levels.

**Table 11.**

| UL (Pending)  | CSA (Pending)   | VDE (Pending)  | CQC (Pending)                                     |
|---|---|--|---|
| Recognized Under UL 1577 Component Recognition Program <sup>1</sup> | Approved under CSA Component Acceptance Notice 5A   | Certified according to DIN V VDE V 0884-10 (VDE V 0884-10):2006-12 <sup>2</sup>        | Certified under CQC11-471543-2015, GB4943.1-2011: |
| Single Protection, 3000 V rms Isolation Voltage                     | CSA 60950-1-07+A1+A2 and IEC 60950-1, second edition, +A1+A2:   | Reinforced insulation, V <sub>IORM</sub> = 565 V peak, V <sub>IOSM</sub> = 6000 V peak | Basic insulation at 400 V rms (565 V peak)        |
| Double Protection, 3000 V rms Isolation Voltage                     | Basic insulation at 400 V rms (565 V peak)<br>Reinforced insulation at 200 V rms (283 V peak)<br>IEC 60601-1 Edition 3.1: basic insulation (one means of patient protection (1 MOPP)), 250 V rms (354 V peak)<br>CSA 61010-1-12 and IEC 61010-1 third edition:<br>Basic insulation at 300 V rms mains, 400 V rms secondary (565 V peak)<br>Reinforced insulation at 150 V rms mains, 200 V secondary (282 V peak) | Basic insulation, V <sub>IORM</sub> = 565 V peak, V <sub>IOSM</sub> = 10 kV peak       |   |
| File E214100  | File 205078   | File 2471900-4880-0001   | File (CQC18001196412)                             |

<sup>1</sup> In accordance with UL 1577, each ADuM150N/ADuM151N/ADuM152N in the R-16 narrow-body (SOIC\_N) package is proof tested by applying an insulation test voltage ≥ 3600 V rms for 1 sec.

<sup>2</sup> In accordance with DIN V VDE V 0884-10, each ADuM150N/ADuM151N/ADuM152N in the R-16 narrow-body (SOIC\_N) package is proof tested by applying an insulation test voltage ≥ 1059 V peak for 1 sec (partial discharge detection limit = 5 pC). The \* marking branded on the component designates DIN V VDE V 0884-10 approval.

**DIN V VDE V 0884-10 (VDE V 0884-10) INSULATION CHARACTERISTICS**

These isolators are suitable for reinforced electrical isolation only within the safety limit data. Protective circuits ensure the maintenance of the safety data. The \* marking on packages denotes DIN V VDE V 0884-10 approval.

Table 12.

| Description   | Test Conditions/Comments   | Symbol      | Characteristic                 | Unit   |
|---|--|-------------|--------------------------------|--------|
| Installation Classification per DIN VDE 0110<br>For Rated Mains Voltage ≤ 150 V rms<br>For Rated Mains Voltage ≤ 300 V rms<br>For Rated Mains Voltage ≤ 600 V rms |  |             | I to IV<br>I to IV<br>I to III |        |
| Climatic Classification   |  |             | 40/125/21                      |        |
| Pollution Degree per DIN VDE 0110, Table 1  |  |             | 2                              |        |
| Maximum Working Insulation Voltage  |  | $V_{IORM}$  | 565                            | V peak |
| Input to Output Test Voltage, Method B1   | $V_{IORM} \times 1.875 = V_{pd(m)}$ , 100% production test,<br>$t_{ini} = t_m = 1$ sec, partial discharge < 5 pC | $V_{pd(m)}$ | 1059                           | V peak |
| Input to Output Test Voltage, Method A  |  | $V_{pd(m)}$ |                                |        |
| After Environmental Tests Subgroup 1  | $V_{IORM} \times 1.5 = V_{pd(m)}$ , $t_{ini} = 60$ sec, $t_m = 10$ sec,<br>partial discharge < 5 pC              |             | 848                            | V peak |
| After Input and/or Safety Test Subgroup 2 and Subgroup 3  | $V_{IORM} \times 1.2 = V_{pd(m)}$ , $t_{ini} = 60$ sec, $t_m = 10$ sec,<br>partial discharge < 5 pC              |             | 678                            | V peak |
| Highest Allowable Overvoltage   |  | $V_{IOTM}$  | 4200                           | V peak |
| Surge Isolation Voltage Basic   | $V_{PEAK} = 10$ kV, 1.2 μs rise time, 50 μs,<br>50% fall time  | $V_{IOSM}$  | 10,000                         | V peak |
| Surge Isolation Voltage Reinforced  | $V_{PEAK} = 10$ kV, 1.2 μs rise time, 50 μs,<br>50% fall time  | $V_{IOSM}$  | 6000                           | V peak |
| Safety Limiting Values  | Maximum value allowed in the event of a failure (see Figure 4)   |             |                                |        |
| Maximum Junction Temperature  |  | $T_S$       | 150                            | °C     |
| Total Power Dissipation at 25°C   |  | $P_S$       | 1.64                           | W      |
| Insulation Resistance at $T_S$  |  | $R_S$       | >10 <sup>9</sup>               | Ω      |

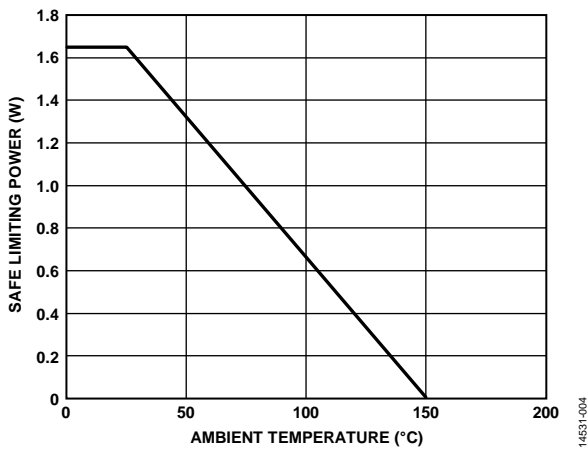

Figure 4. Thermal Derating Curve, Dependence of Safety Limiting Values with Ambient Temperature per DIN V VDE V 0884-10

**RECOMMENDED OPERATING CONDITIONS**

Table 13.

| Parameter                        | Symbol             | Rating          |
|----------------------------------|--------------------|-----------------|
| Operating Temperature            | $T_A$              | -40°C to +125°C |
| Supply Voltages                  | $V_{DD1}, V_{DD2}$ | 1.7 V to 5.5 V  |
| Input Signal Rise and Fall Times |                    | 1.0 ms          |

## ABSOLUTE MAXIMUM RATINGS

T<sub>A</sub> = 25°C, unless otherwise noted.

Table 14.

| Parameter  | Rating  |
|--|---|
| Storage Temperature (T <sub>ST</sub> ) Range   | –65°C to +150°C                                 |
| Ambient Operating Temperature (T <sub>A</sub> ) Range  | –40°C to +125°C                                 |
| Supply Voltages (V <sub>DD1</sub> , V <sub>DD2</sub> )   | –0.5 V to +7.0 V                                |
| Input Voltages (V <sub>IA</sub> , V <sub>IB</sub> , V <sub>IC</sub> , V <sub>ID</sub> , V <sub>IE</sub> )  | –0.5 V to V <sub>DD1</sub> <sup>1</sup> + 0.5 V |
| Output Voltages (V <sub>OA</sub> , V <sub>OB</sub> , V <sub>OC</sub> , V <sub>OD</sub> , V <sub>OE</sub> ) | –0.5 V to V <sub>DDO</sub> <sup>2</sup> + 0.5 V |
| Average Output Current per Pin <sup>3</sup>  |   |
| Side 1 Output Current (I <sub>O1</sub> )   | –10 mA to +10 mA                                |
| Side 2 Output Current (I <sub>O2</sub> )   | –10 mA to +10 mA                                |
| Common-Mode Transients <sup>4</sup>  | –150 kV/μs to +150 kV/μs                        |

<sup>1</sup> V<sub>DD1</sub> is the input side supply voltage.

<sup>2</sup> V<sub>DDO</sub> is the output side supply voltage.

<sup>3</sup> See Figure 4 for the maximum rated current values for various temperatures.

<sup>4</sup> Refers to the common-mode transients across the insulation barrier.

Common-mode transients exceeding the absolute maximum ratings may cause latch-up or permanent damage.

Stresses at or above those listed under Absolute Maximum Ratings may cause permanent damage to the product. This is a stress rating only; functional operation of the product at these or any other conditions above those indicated in the operational section of this specification is not implied. Operation beyond the maximum operating conditions for extended periods may affect product reliability.

### ESD CAUTION



**ESD (electrostatic discharge) sensitive device.** Charged devices and circuit boards can discharge without detection. Although this product features patented or proprietary protection circuitry, damage may occur on devices subjected to high energy ESD. Therefore, proper ESD precautions should be taken to avoid performance degradation or loss of functionality.

Table 15. Maximum Continuous Working Voltage<sup>1</sup>

| Parameter             | Rating     | Constraint  |
|-----------------------|------------|---|
| AC Voltage            |            |   |
| Bipolar Waveform      |            |   |
| Basic Insulation      | 789 V peak | Lifetime limited by package creepage maximum approved working voltage per IEC 60950-1 |
| Reinforced Insulation | 403 V peak | Lifetime limited by package creepage maximum approved working voltage per IEC 60950-1 |
| Unipolar Waveform     |            |   |
| Basic Insulation      | 909 V peak | Lifetime limited by package creepage maximum approved working voltage per IEC 60950-1 |
| Reinforced Insulation | 469 V peak | Lifetime limited by package creepage maximum approved working voltage per IEC 60950-1 |
| DC Voltage            |            |   |
| Basic Insulation      | 558 V peak | Lifetime limited by package creepage maximum approved working voltage per IEC 60950-1 |
| Reinforced Insulation | 285 V peak | Lifetime limited by package creepage maximum approved working voltage per IEC 60950-1 |

<sup>1</sup> Refers to the continuous voltage magnitude imposed across the isolation barrier. See the Insulation Lifetime section for more details.

### Truth Table

Table 16. ADuM150N/ADuM151N/ADuM152N Truth Table (Positive Logic)

| V <sub>ix</sub> Input <sup>1,2</sup> | V <sub>DD1</sub> State <sup>2</sup> | V <sub>DDO</sub> State <sup>2</sup> | Default Low (N0), V <sub>Ox</sub> Output <sup>1,2,3</sup> | Default High (N1), V <sub>Ox</sub> Output <sup>1,2,3</sup> | Test Conditions/Comments |
|--------------------------------------|-------------------------------------|-------------------------------------|---|--|--------------------------|
| L                                    | Powered                             | Powered                             | L   | L  | Normal operation         |
| H                                    | Powered                             | Powered                             | H   | H  | Normal operation         |
| L                                    | Unpowered                           | Powered                             | L   | H  | Fail-safe output         |
| X <sup>4</sup>                       | Powered                             | Unpowered                           | Indeterminate   | Indeterminate  | Output unpowered         |

<sup>1</sup> L means low, H means high, and X means don't care.

<sup>2</sup> V<sub>ix</sub> and V<sub>Ox</sub> refer to the input and output signals of a given channel (A, B, C, D, or E). V<sub>DD1</sub> and V<sub>DDO</sub> refer to the supply voltages on the input and output sides of the given channel, respectively.

<sup>3</sup> N0 refers to the ADuM150N0/ADuM151N0/ADuM152N0 models, N1 refers to the ADuM150N1/ADuM151N1/ADuM152N1 models. See the Ordering Guide section.

<sup>4</sup> Input pins (V<sub>ix</sub>) on the same side as an unpowered supply must be in a low state to avoid powering the device through its ESD protection circuitry.

## PIN CONFIGURATIONS AND FUNCTION DESCRIPTIONS

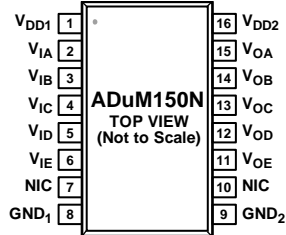

NOTES  
1. NIC = NO INTERNAL CONNECTION.

14531-005

Figure 5. ADuM150N Pin Configuration

Table 17. ADuM150N Pin Function Descriptions

| Pin No. <sup>1</sup> | Mnemonic         | Description                                      |
|----------------------|------------------|--|
| 1                    | V <sub>DD1</sub> | Supply Voltage for Isolator Side 1.              |
| 2                    | V <sub>IA</sub>  | Logic Input A.                                   |
| 3                    | V <sub>IB</sub>  | Logic Input B.                                   |
| 4                    | V <sub>IC</sub>  | Logic Input C.                                   |
| 5                    | V <sub>ID</sub>  | Logic Input D.                                   |
| 6                    | V <sub>IE</sub>  | Logic Input E.                                   |
| 7                    | NIC              | No Internal Connection. Leave this pin floating. |
| 8                    | GND <sub>1</sub> | Ground 1. Ground reference for Isolator Side 1.  |
| 9                    | GND <sub>2</sub> | Ground 2. Ground reference for Isolator Side 2.  |
| 10                   | NIC              | No Internal Connection. Leave this pin floating. |
| 11                   | V <sub>OE</sub>  | Logic Output E.                                  |
| 12                   | V <sub>OD</sub>  | Logic Output D.                                  |
| 13                   | V <sub>OC</sub>  | Logic Output C.                                  |
| 14                   | V <sub>OB</sub>  | Logic Output B.                                  |
| 15                   | V <sub>OA</sub>  | Logic Output A.                                  |
| 16                   | V <sub>DD2</sub> | Supply Voltage for Isolator Side 2.              |

<sup>1</sup> Reference the [AN-1109 Application Note](#) for specific layout guidelines.

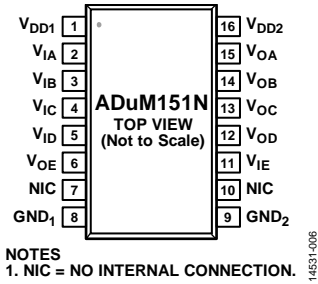

Figure 6. ADuM151N Pin Configuration

Table 18. ADuM151N Pin Function Descriptions

| Pin No. <sup>1</sup> | Mnemonic         | Description                                      |
|----------------------|------------------|--|
| 1                    | V <sub>DD1</sub> | Supply Voltage for Isolator Side 1.              |
| 2                    | V <sub>IA</sub>  | Logic Input A.                                   |
| 3                    | V <sub>IB</sub>  | Logic Input B.                                   |
| 4                    | V <sub>IC</sub>  | Logic Input C.                                   |
| 5                    | V <sub>ID</sub>  | Logic Input D.                                   |
| 6                    | V <sub>OE</sub>  | Logic Output E.                                  |
| 7                    | NIC              | No Internal Connection. Leave this pin floating. |
| 8                    | GND <sub>1</sub> | Ground 1. Ground reference for Isolator Side 1.  |
| 9                    | GND <sub>2</sub> | Ground 2. Ground reference for Isolator Side 2.  |
| 10                   | NIC              | No Internal Connection. Leave this pin floating. |
| 11                   | V <sub>IE</sub>  | Logic Input E.                                   |
| 12                   | V <sub>OD</sub>  | Logic Output D.                                  |
| 13                   | V <sub>OC</sub>  | Logic Output C.                                  |
| 14                   | V <sub>OB</sub>  | Logic Output B.                                  |
| 15                   | V <sub>OA</sub>  | Logic Output A.                                  |
| 16                   | V <sub>DD2</sub> | Supply Voltage for Isolator Side 2.              |

<sup>1</sup> Reference the [AN-1109 Application Note](#) for specific layout guidelines.

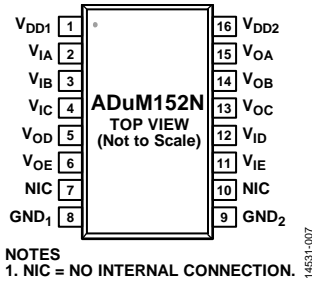

Figure 7. ADuM152N Pin Configuration

Table 19. ADuM152N Pin Function Descriptions

| Pin No. <sup>1</sup> | Mnemonic         | Description                                      |
|----------------------|------------------|--|
| 1                    | V <sub>DD1</sub> | Supply Voltage for Isolator Side 1.              |
| 2                    | V <sub>IA</sub>  | Logic Input A.                                   |
| 3                    | V <sub>IB</sub>  | Logic Input B.                                   |
| 4                    | V <sub>IC</sub>  | Logic Input C.                                   |
| 5                    | V <sub>OD</sub>  | Logic Output D.                                  |
| 6                    | V <sub>OE</sub>  | Logic Output E.                                  |
| 7                    | NIC              | No Internal Connection. Leave this pin floating. |
| 8                    | GND <sub>1</sub> | Ground 1. Ground reference for Isolator Side 1.  |
| 9                    | GND <sub>2</sub> | Ground 2. Ground reference for Isolator Side 2.  |
| 10                   | NIC              | No Internal Connection. Leave this pin floating. |
| 11                   | V <sub>IE</sub>  | Logic Input E.                                   |
| 12                   | V <sub>ID</sub>  | Logic Input D.                                   |
| 13                   | V <sub>OC</sub>  | Logic Output C.                                  |
| 14                   | V <sub>OB</sub>  | Logic Output B.                                  |
| 15                   | V <sub>OA</sub>  | Logic Output A.                                  |
| 16                   | V <sub>DD2</sub> | Supply Voltage for Isolator Side 2.              |

<sup>1</sup> Reference the [AN-1109 Application Note](#) for specific layout guidelines.



TYPICAL PERFORMANCE CHARACTERISTICS

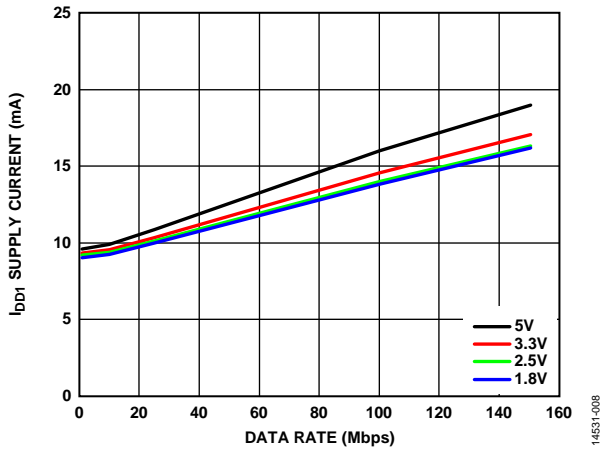

Figure 8. ADuM150N  $I_{DD1}$  Supply Current vs. Data Rate at Various Voltages

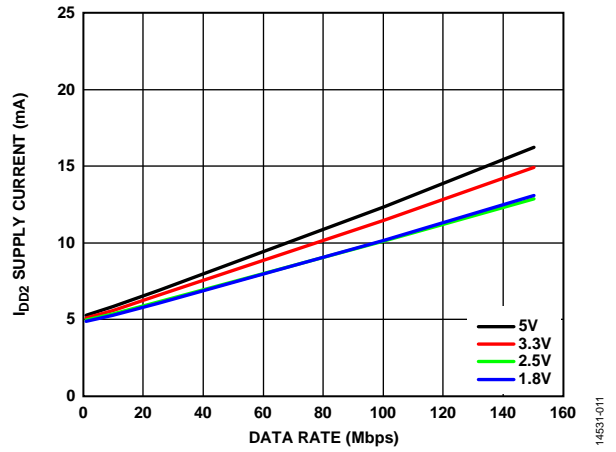

Figure 11. ADuM151N  $I_{DD2}$  Supply Current vs. Data Rate at Various Voltages

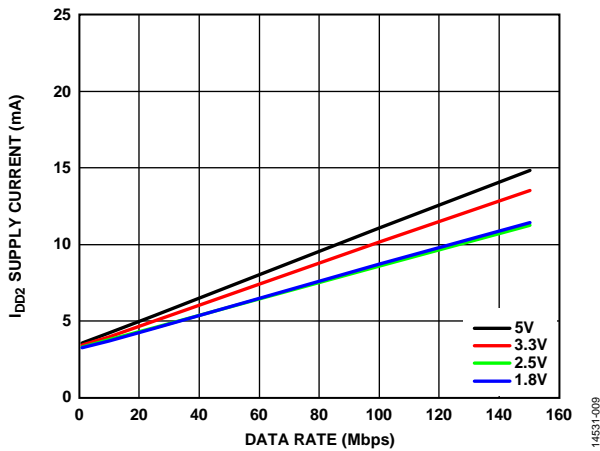

Figure 9. ADuM150N  $I_{DD2}$  Supply Current vs. Data Rate at Various Voltages

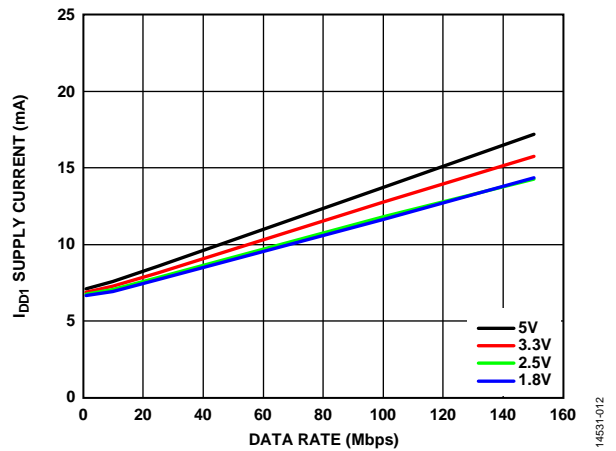

Figure 12. ADuM152N  $I_{DD1}$  Supply Current vs. Data Rate at Various Voltages

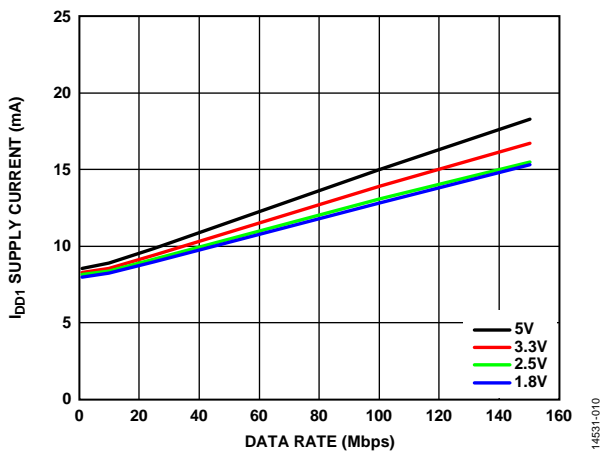

Figure 10. ADuM151N  $I_{DD1}$  Supply Current vs. Data Rate at Various Voltages

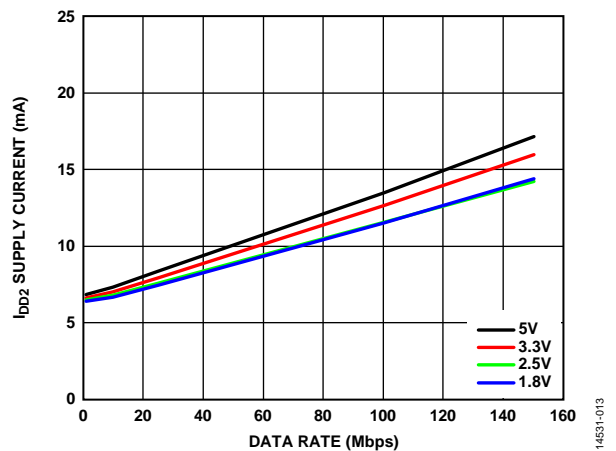

Figure 13. ADuM152N  $I_{DD2}$  Supply Current vs. Data Rate at Various Voltages

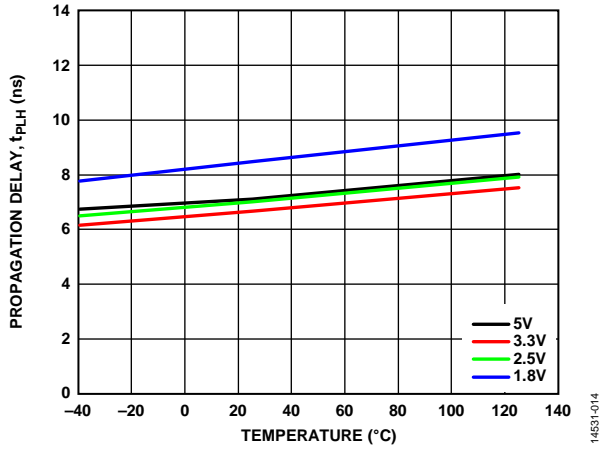

Figure 14. Propagation Delay,  $t_{PLH}$  vs. Temperature at Various Voltages

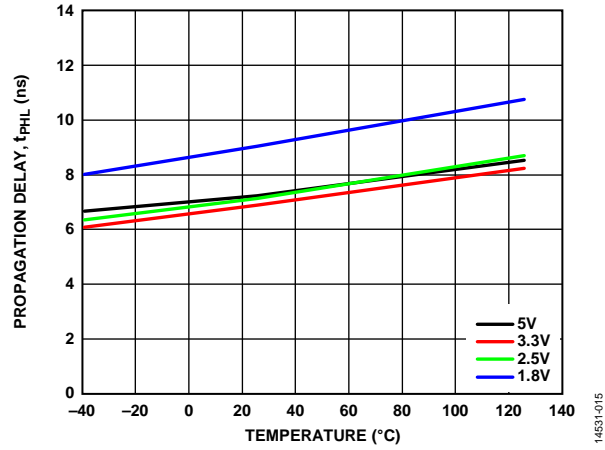

Figure 15. Propagation Delay,  $t_{PHL}$  vs. Temperature at Various Voltages

### THEORY OF OPERATION

The ADuM150N/ADuM151N/ADuM152N use a high frequency carrier to transmit data across the isolation barrier using iCoupler chip scale transformer coils separated by layers of polyimide isolation. Using an on/off keying (OOK) technique and the differential architecture shown in Figure 16 and Figure 17, the ADuM150N/ADuM151N/ADuM152N have very low propagation delay and high speed. Internal regulators and supply voltages allow logic and supply voltages over a wide range from 1.7 V to 5.5 V, offering voltage translation of 1.8 V, 2.5 V, 3.3 V, and 5 V logic. The architecture is designed for high common-mode transient immunity and high immunity to electrical noise and magnetic interference. Radiated emissions are minimized with a spread spectrum OOK carrier and other techniques.

Figure 16 shows the waveforms for models of the ADuM150N0/ADuM151N0/ADuM152N0 that have the condition of the fail-safe output state equal to low, where the carrier waveform is off when the input state is low. If the input side is off or not operating, the fail-safe output state of low sets the output to low. For the ADuM150N1/ADuM151N1/ADuM152N1 that have a fail-safe output state of high, Figure 17 illustrates the conditions where the carrier waveform is off when the input state is high. When the input side is off or not operating, the fail-safe output state of high sets the output to high. See the Ordering Guide for the model numbers that have the fail-safe output state of low or the fail-safe output state of high.

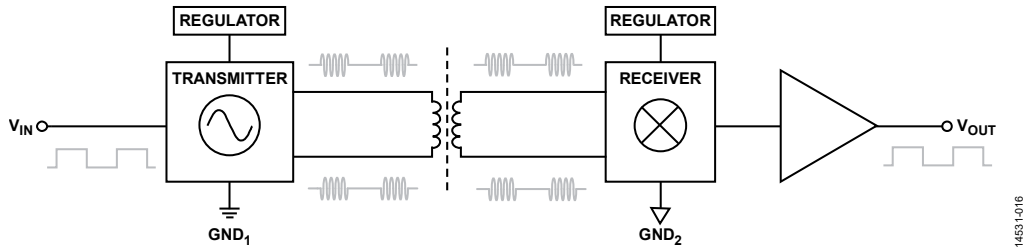

Figure 16. Operational Block Diagram of a Single Channel with a Low Fail-Safe Output State

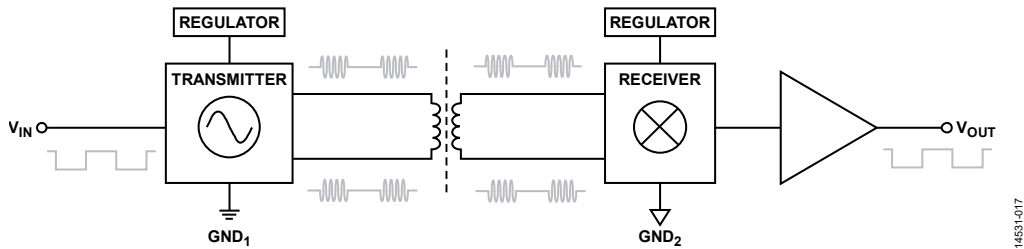

Figure 17. Operational Block Diagram of a Single Channel with a High Fail-Safe Output State

## APPLICATIONS INFORMATION

### PCB LAYOUT

The ADuM150N/ADuM151N/ADuM152N digital isolators require no external interface circuitry for the logic interfaces. Power supply bypassing is strongly recommended at the input and output supply pins (see Figure 18). Bypass capacitors are connected between Pin 1 and Pin 8 for  $V_{DD1}$  and between Pin 9 and Pin 16 for  $V_{DD2}$ . The recommended bypass capacitor value is between 0.01  $\mu$ F and 0.1  $\mu$ F. The total lead length between both ends of the capacitor and the input power supply pin must not exceed 10 mm.

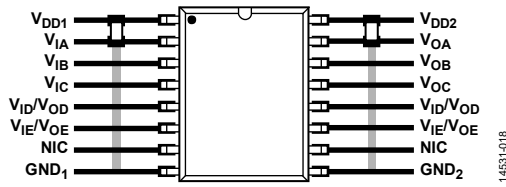

Figure 18. Recommended Printed Circuit Board Layout

In applications involving high common-mode transients, ensure that board coupling across the isolation barrier is minimized. Furthermore, design the board layout such that any coupling that does occur equally affects all pins on a given component side. Failure to ensure this can cause voltage differentials between pins exceeding the Absolute Maximum Ratings of the device, thereby leading to latch-up or permanent damage.

See the AN-1109 Application Note for board layout guidelines.

### PROPAGATION DELAY RELATED PARAMETERS

Propagation delay is a parameter that describes the time it takes a logic signal to propagate through a component. The propagation delay to a Logic 0 output may differ from the propagation delay to a Logic 1 output.

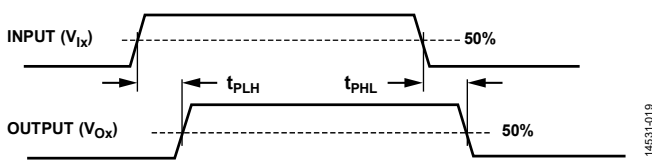

Figure 19. Propagation Delay Parameters

Pulse width distortion is the maximum difference between these two propagation delay values and is an indication of how accurately the timing of the input signal is preserved.

Channel matching is the maximum amount the propagation delay differs between channels within a single ADuM150N/ADuM151N/ADuM152N component.

Propagation delay skew is the maximum amount the propagation delay differs between multiple ADuM150N/ADuM151N/ADuM152N components operating under the same conditions.

### JITTER MEASUREMENT

Figure 20 shows the eye diagram for the ADuM150N/ADuM151N/ADuM152N. The measurement was taken using an Agilent 81110A pulse pattern generator at 150 Mbps with pseudorandom bit sequences (PRBS)  $2(n - 1)$ ,  $n = 14$ , for 5 V supplies. Jitter was measured with the Tektronix Model 5104B oscilloscope, 1 GHz, 10 GSps with the DPOJET jitter and eye diagram analysis tools. The result shows a typical measurement on the ADuM150N/ADuM151N/ADuM152N with 490 ps p-p jitter.

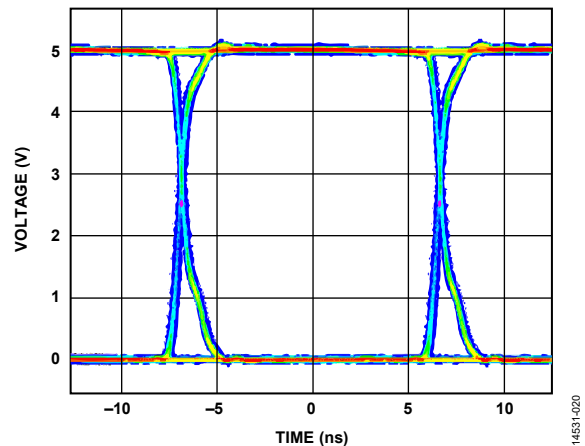

Figure 20. ADuM150N/ADuM151N/ADuM152N Eye Diagram

### INSULATION LIFETIME

All insulation structures eventually break down when subjected to voltage stress over a sufficiently long period. The rate of insulation degradation is dependent on the characteristics of the voltage waveform applied across the insulation as well as on the materials and material interfaces.

The two types of insulation degradation of primary interest are breakdown along surfaces exposed to the air and insulation wear out. Surface breakdown is the phenomenon of surface tracking, and the primary determinant of surface creepage requirements in system level standards. Insulation wear out is the phenomenon where charge injection or displacement currents inside the insulation material cause long-term insulation degradation.

#### Surface Tracking

Surface tracking is addressed in electrical safety standards by setting a minimum surface creepage based on the working voltage, the environmental conditions, and the properties of the insulation material. Safety agencies perform characterization testing on the surface insulation of components that allows the components to be categorized in different material groups. Lower material group ratings are more resistant to surface tracking and, therefore, can provide adequate lifetime with smaller creepage. The minimum creepage for a given working voltage and material group is in each system level standard and is based on the total rms voltage across the isolation, pollution degree, and material group. The material group and creepage for the ADuM150N/ADuM151N/ADuM152N isolators are presented in Table 9.

**Insulation Wear Out**

The lifetime of insulation caused by wear out is determined by its thickness, material properties, and the voltage stress applied. It is important to verify that the product lifetime is adequate at the application working voltage. The working voltage supported by an isolator for wear out may not be the same as the working voltage supported for tracking. The working voltage applicable to tracking is specified in most standards.

Testing and modeling have shown that the primary driver of long-term degradation is displacement current in the polyimide insulation causing incremental damage. The stress on the insulation can be broken down into broad categories, such as: dc stress, which causes very little wear out because there is no displacement current, and an ac component time varying voltage stress, which causes wear out.

The ratings in certification documents are usually based on 60 Hz sinusoidal stress because this reflects isolation from line voltage. However, many practical applications have combinations of 60 Hz ac and dc across the barrier as shown in Equation 1. Because only the ac portion of the stress causes wear out, the equation can be rearranged to solve for the ac rms voltage, as is shown in Equation 2. For insulation wear out with the polyimide materials used in these products, the ac rms voltage determines the product lifetime.

$$V_{RMS} = \sqrt{V_{AC\ RMS}^2 + V_{DC}^2} \tag{1}$$

or

$$V_{AC\ RMS} = \sqrt{V_{RMS}^2 - V_{DC}^2} \tag{2}$$

where:

$V_{AC\ RMS}$  is the time varying portion of the working voltage.

$V_{RMS}$  is the total rms working voltage.

$V_{DC}$  is the dc offset of the working voltage.

**Calculation and Use of Parameters Example**

The following example frequently arises in power conversion applications. Assume that the line voltage on one side of the isolation is 240 V ac rms and a 400 V dc bus voltage is present on the other side of the isolation barrier. The isolator material is polyimide. To establish the critical voltages in determining the creepage, clearance, and lifetime of a device, see Figure 21 and the following equations.

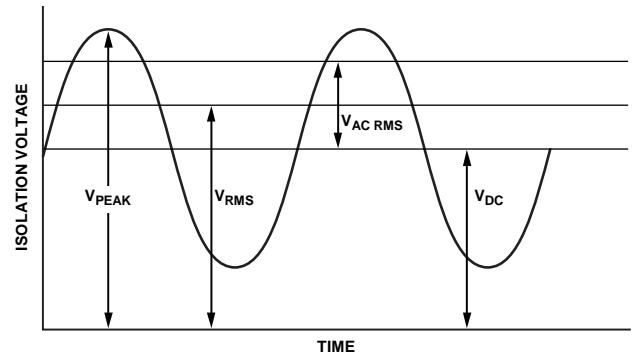

Figure 21. Critical Voltage Example

The working voltage across the barrier from Equation 1 is

$$V_{RMS} = \sqrt{V_{AC\ RMS}^2 + V_{DC}^2}$$

$$V_{RMS} = \sqrt{240^2 + 400^2}$$

$$V_{RMS} = 466\ V$$

This  $V_{RMS}$  value is the working voltage used together with the material group and pollution degree when looking up the creepage required by a system standard.

To determine if the lifetime is adequate, obtain the time varying portion of the working voltage. To obtain the ac rms voltage, use Equation 2.

$$V_{AC\ RMS} = \sqrt{V_{RMS}^2 - V_{DC}^2}$$

$$V_{AC\ RMS} = \sqrt{466^2 - 400^2}$$

$$V_{AC\ RMS} = 240\ V\ rms$$

In this case, the ac rms voltage is simply the line voltage of 240 V rms. This calculation is more relevant when the waveform is not sinusoidal. The value is compared to the limits for working voltage in Table 15 for the expected lifetime, less than a 60 Hz sine wave, and it is well within the limit for a 50-year service life.

Note that the dc working voltage limit in Table 15 is set by the creepage of the package as specified in IEC 60664-1. This value can differ for specific system level standards.

OUTLINE DIMENSIONS

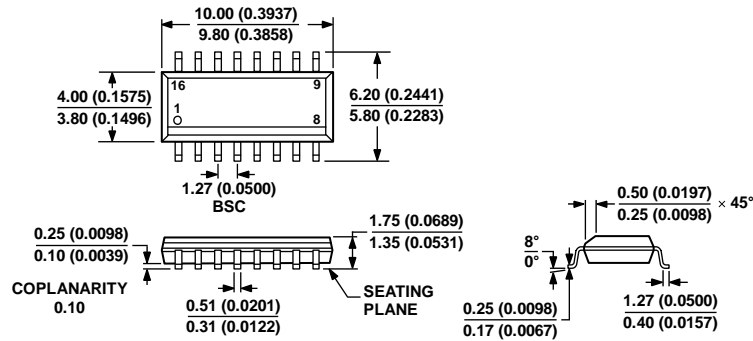

COMPLIANT TO JEDEC STANDARDS MS-012-AC  
 CONTROLLING DIMENSIONS ARE IN MILLIMETERS; INCH DIMENSIONS (IN PARENTHESES) ARE ROUNDED-OFF MILLIMETER EQUIVALENTS FOR REFERENCE ONLY AND ARE NOT APPROPRIATE FOR USE IN DESIGN.

Figure 22. 16-Lead Standard Small Outline Package [SOIC\_N] Narrow Body (R-16)  
 Dimensions shown in millimeters and (inches)

ORDERING GUIDE

| Model <sup>1</sup> | Temperature Range | No. of Inputs, V <sub>DD1</sub> Side | No. of Inputs, V <sub>DD2</sub> Side | Withstand Voltage Rating (kV rms) | Fail-Safe Output State | Package Description          | Package Option |
|--------------------|-------------------|--------------------------------------|--------------------------------------|-----------------------------------|------------------------|------------------------------|----------------|
| ADuM150N1BRZ       | -40°C to +125°C   | 5                                    | 0                                    | 3.0                               | High                   | 16-Lead SOIC_N               | R-16           |
| ADuM150N1BRZ-RL7   | -40°C to +125°C   | 5                                    | 0                                    | 3.0                               | High                   | 16-Lead SOIC_N, 7" Reel      | R-16           |
| ADuM150N0BRZ       | -40°C to +125°C   | 5                                    | 0                                    | 3.0                               | Low                    | 16-Lead SOIC_N               | R-16           |
| ADuM150N0BRZ-RL7   | -40°C to +125°C   | 5                                    | 0                                    | 3.0                               | Low                    | 16-Lead SOIC_N, 7" Reel      | R-16           |
| ADuM151N1BRZ       | -40°C to +125°C   | 4                                    | 1                                    | 3.0                               | High                   | 16-Lead SOIC_N               | R-16           |
| ADuM151N1BRZ-RL7   | -40°C to +125°C   | 4                                    | 1                                    | 3.0                               | High                   | 16-Lead SOIC_N, 7" Reel      | R-16           |
| ADuM151N0BRZ       | -40°C to +125°C   | 4                                    | 1                                    | 3.0                               | Low                    | 16-Lead SOIC_N               | R-16           |
| ADuM151N0BRZ-RL7   | -40°C to +125°C   | 4                                    | 1                                    | 3.0                               | Low                    | 16-Lead SOIC_N, 7" Reel      | R-16           |
| ADuM152N1BRZ       | -40°C to +125°C   | 3                                    | 2                                    | 3.0                               | High                   | 16-Lead SOIC_N               | R-16           |
| ADuM152N1BRZ-RL7   | -40°C to +125°C   | 3                                    | 2                                    | 3.0                               | High                   | 16-Lead SOIC_N, 7" Reel      | R-16           |
| ADuM152N0BRZ       | -40°C to +125°C   | 3                                    | 2                                    | 3.0                               | Low                    | 16-Lead SOIC_N               | R-16           |
| ADuM152N0BRZ-RL7   | -40°C to +125°C   | 3                                    | 2                                    | 3.0                               | Low                    | 16-Lead SOIC_N, 7" Reel      | R-16           |
| EVAL-5CH6CHSOICEBZ |                   |                                      |                                      |                                   |                        | Unpopulated Evaluation Board |                |
| EVAL-ADuM163N0EBZ  |                   |                                      |                                      |                                   |                        | Populated Evaluation Board   |                |

<sup>1</sup> Z = RoHS Compliant Part.



## Стандарт Электрон Связь

Мы молодая и активно развивающаяся компания в области поставок электронных компонентов. Мы поставляем электронные компоненты отечественного и импортного производства напрямую от производителей и с крупнейших складов мира.

Благодаря сотрудничеству с мировыми поставщиками мы осуществляем комплексные и плановые поставки широчайшего спектра электронных компонентов.

Собственная эффективная логистика и склад в обеспечивает надежную поставку продукции в точно указанные сроки по всей России.

Мы осуществляем техническую поддержку нашим клиентам и предпродажную проверку качества продукции. На все поставляемые продукты мы предоставляем гарантию .

Осуществляем поставки продукции под контролем ВП МО РФ на предприятия военно-промышленного комплекса России , а также работаем в рамках 275 ФЗ с открытием отдельных счетов в уполномоченном банке. Система менеджмента качества компании соответствует требованиям ГОСТ ISO 9001.

Минимальные сроки поставки, гибкие цены, неограниченный ассортимент и индивидуальный подход к клиентам являются основой для выстраивания долгосрочного и эффективного сотрудничества с предприятиями радиоэлектронной промышленности, предприятиями ВПК и научно-исследовательскими институтами России.

С нами вы становитесь еще успешнее!

### Наши контакты:

**Телефон:** +7 812 627 14 35

**Электронная почта:** [sales@st-electron.ru](mailto:sales@st-electron.ru)

**Адрес:** 198099, Санкт-Петербург,  
Промышленная ул, дом № 19, литера Н,  
помещение 100-Н Офис 331