

Optocoupler, Phototriac Output, Zero Crossing, High dV/dt, Low Input Current

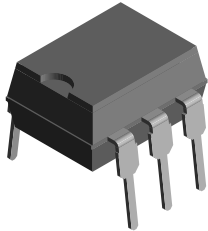

I179030

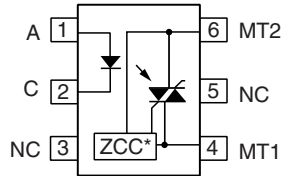

*Zero Crossing Circuit

FEATURES

- High static dV/dt 5 kV/ μ s
- High input sensitivity $I_{FT} = 1.6, 2, \text{ and } 3 \text{ mA}$
- 300 mA on-state current
- Zero voltage crossing detector
- 400, and 600 V blocking voltage
- Isolation test voltage 5300 V_{RMS}

RoHS
COMPLIANT

APPLICATIONS

- Solid-state relays
- Industrial controls
- Office equipment
- Consumer appliances

AGENCY APPROVALS

- UL1577, file no. E52744 system code H or J, double protection
- CUL - file no. E52744, equivalent to CSA bulletin 5A
- DIN EN 60747-5-2 (VDE 0884) available with option 1

DESCRIPTION

The VO4154/VO4156 consists of a GaAs IRLED optically coupled to a photosensitive zero crossing TRIAC packaged in a DIP-6 package.

High input sensitivity is achieved by using an emitter follower phototransistor and a cascaded SCR predriver resulting in an LED trigger current of 1.6 mA for bin D, 2 mA for bin H, and 3 mA for bin M.

The new phototriac zero crossing family uses a proprietary dV/dt clamp resulting in a static dV/dt of greater than 5 kV/ μ s.

The VO4154/VO4156 isolates low-voltage logic from 120, 240, and 380 VAC lines to control resistive, inductive, or capacitive loads including motors, solenoids, high current thyristors or TRIAC and relays.

ORDER INFORMATION	
PART	REMARKS
VO4154D	400 V V_{DRM} , $I_{ft} = 1.6 \text{ mA}$, DIP-6
VO4154D-X006	400 V V_{DRM} , $I_{ft} = 1.6 \text{ mA}$, DIP-6 400 mil
VO4154D-X007	400 V V_{DRM} , $I_{ft} = 1.6 \text{ mA}$, SMD-6
VO4154H	400 V V_{DRM} , $I_{ft} = 2 \text{ mA}$, DIP-6
VO4154H-X006	400 V V_{DRM} , $I_{ft} = 2 \text{ mA}$, DIP-6 400 mil
VO4154H-X007	400 V V_{DRM} , $I_{ft} = 2 \text{ mA}$, SMD-6
VO4154M	400 V V_{DRM} , $I_{ft} = 3 \text{ mA}$, DIP-6
VO4154M-X006	400 V V_{DRM} , $I_{ft} = 3 \text{ mA}$, DIP-6 400 mil
VO4154M-X007	400 V V_{DRM} , $I_{ft} = 3 \text{ mA}$, SMD-6
VO4156D	600 V V_{DRM} , $I_{ft} = 1.6 \text{ mA}$, DIP-6
VO4156D-X006	600 V V_{DRM} , $I_{ft} = 1.6 \text{ mA}$, DIP-6 400 mil
VO4156D-X007	600 V V_{DRM} , $I_{ft} = 1.6 \text{ mA}$, SMD-6
VO4156H	600 V V_{DRM} , $I_{ft} = 2 \text{ mA}$, DIP-6
VO4156H-X006	600 V V_{DRM} , $I_{ft} = 2 \text{ mA}$, DIP-6 400 mil
VO4156H-X007	600 V V_{DRM} , $I_{ft} = 2 \text{ mA}$, SMD-6
VO4156M	600 V V_{DRM} , $I_{ft} = 3 \text{ mA}$, DIP-6
VO4156M-X006	600 V V_{DRM} , $I_{ft} = 3 \text{ mA}$, DIP-6 400 mil
VO4156M-X007	600 V V_{DRM} , $I_{ft} = 3 \text{ mA}$, SMD-6

Note

For additional information on the available options refer to option information.

ABSOLUTE MAXIMUM RATINGS					
PARAMETER	TEST CONDITION	PART	SYMBOL	VALUE	UNIT
INPUT					
Reverse voltage			V_R	6	V
Forward current			I_F	60	mA
Surge current			I_{FSM}	2.5	A
Power dissipation			P_{diss}	100	mW
Derate from 25 °C				1.33	mW/°C
OUTPUT					
Peak off-state voltage		VO4154D/H/M	V_{DRM}	400	V
		VO4156D/H/M	V_{DRM}	600	V
RMS on-state current			I_{TM}	300	mA
Total power dissipation			P_{diss}	500	mW
Derate from 25 °C				6.6	mW/°C
COUPLER					
Isolation test voltage (between emitter and detector, climate per DIN 500414, part 2, Nov. 74)	t = 1 min		V_{ISO}	5300	V_{RMS}
Storage temperature range			T_{stg}	- 55 to + 150	°C
Ambient temperature range			T_{amb}	- 55 to + 100	°C
Soldering temperature	max. ≤ 10 s dip soldering ≥ 0.5 mm from case bottom		T_{sld}	260	°C

Note

$T_{amb} = 25\text{ °C}$, unless otherwise specified.

Stresses in excess of the absolute Maximum Ratings can cause permanent damage to the device. Functional operation of the device is not implied at these or any other conditions in excess of those given in the operational sections of this document. Exposure to absolute Maximum Rating for extended periods of the time can adversely affect reliability.

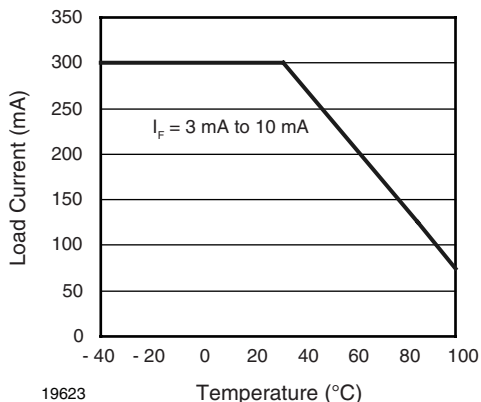
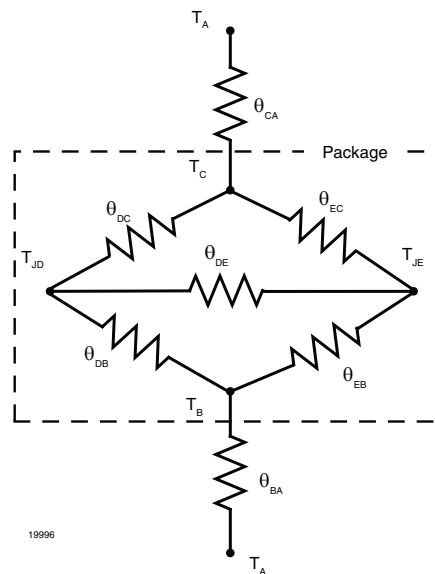

Fig. 1 - Recommended Operating Condition

THERMAL CHARACTERISTICS				
PARAMETER	TEST CONDITION	SYMBOL	VALUE	UNIT
LED power dissipation	at 25 °C	P_{diss}	100	mW
Output power dissipation	at 25 °C	P_{diss}	500	mW
Maximum LED junction temperature		T_{jmax}	125	°C
Maximum output die junction temperature		T_{jmax}	125	°C
Thermal resistance, junction emitter to board		θ_{EB}	150	°C/W
Thermal resistance, junction emitter to case		θ_{EC}	139	°C/W
Thermal resistance, junction detector to board		θ_{DB}	78	°C/W
Thermal resistance, junction detector to case		θ_{DC}	103	°C/W
Thermal resistance, junction emitter to junction detector		θ_{ED}	496	°C/W
Thermal resistance, case to ambient		θ_{CA}	3563	°C/W

Note

The thermal model is represented in the thermal network below. Each resistance value given in this model can be used to calculate the temperatures at each node for a given operating condition. The thermal resistance from board to ambient will be dependent on the type of PCB, layout and thickness of copper traces. For a detailed explanation of the thermal model, please reference Vishay's Thermal Characteristics of Optocouplers Application note.



ELECTRICAL CHARACTERISTICS							
PARAMETER	TEST CONDITION	PART	SYMBOL	MIN.	TYP.	MAX.	UNIT
INPUT							
Forward voltage	$I_F = 10 \text{ mA}$		V_F		1.2	1.4	V
Reverse current	$V_R = 6 \text{ V}$		I_R		0.1	10	μA
Input capacitance	$V_F = 0 \text{ V}, f = 1 \text{ MHz}$		C_I		25		pF
OUTPUT							
Repetitive peak off-state voltage	$I_{\text{DRM}} = 100 \mu\text{A}$	VO4154D/H/M	V_{DRM}	400			V
		VO4156D/H/M	V_{DRM}	600			V
Off-state current	$V_D = V_{\text{DRM}}, I_F = 0$		I_{DRM}			100	μA
On-state voltage	$I_T = 300 \text{ mA}$		V_{TM}			3	V
On-state current	$\text{PF} = 1, V_{\text{T(RMS)}} = 1.7 \text{ V}$		I_{TM}			300	mA
Off-state current in inhibit state	$I_F = 2 \text{ mA}, V_{\text{DRM}}$		I_{DINH}			200	μA
Holding current			I_H			500	μA
Zero cross inhibit voltage	$I_F = \text{rated } I_{\text{FT}}$		V_{IH}			20	V
Critical rate of rise of off-state voltage	$V_D = 0.67 V_{\text{DRM}}, T_J = 25 \text{ }^\circ\text{C}$		dV/dt_{cr}	5000			V/ μs
Critical rate of rise of on-state			dV/dt_{cr}	8			A/ μs
COUPLER							
LED trigger current, current required to latch output	$V_D = 3 \text{ V}$	VO4154D	I_{FT}			1.6	mA
		VO4154H	I_{FT}			2	mA
		VO4154M	I_{FT}			3	mA
		VO4156D	I_{FT}			1.6	mA
		VO4156H	I_{FT}			2	mA
		VO4156M	I_{FT}			3	mA
Common mode coupling capacitance			C_{CM}		0.01		pF
Capacitance (input-output)	$f = 1 \text{ MHz}, V_{\text{IO}} = 0 \text{ V}$		C_{IO}		0.8		pF

Note

$T_{\text{amb}} = 25 \text{ }^\circ\text{C}$, unless otherwise specified.

Minimum and maximum values were tested requirements. Typical values are characteristics of the device and are the result of engineering evaluations. Typical values are for information only and are not part of the testing requirements.

SAFETY AND INSULATION RATINGS							
PARAMETER	TEST CONDITION	SYMBOL	MIN.	TYP.	MAX.	UNIT	
Climatic classification (according to IEC 68 part 1)				55/100/21			
Pollution degree (DIN VDE 0109)				2			
Comparative tracking index per DIN IEC 112/VDE 0303 part 1, group IIIa per DIN VDE 6110 175 399			175		399		
V_{IOTM}		V_{IOTM}	8000				V
V_{IORM}		V_{IORM}	890				V
P_{SO}		P_{SO}			500		mW
I_{SI}		I_{SI}			250		mA
T_{SI}		T_{SI}			175		$^\circ\text{C}$
Creepage			7				mm
Crearance			7				mm



TYPICAL CHARACTERISTICS

T_{amb} = 25 °C, unless otherwise specified

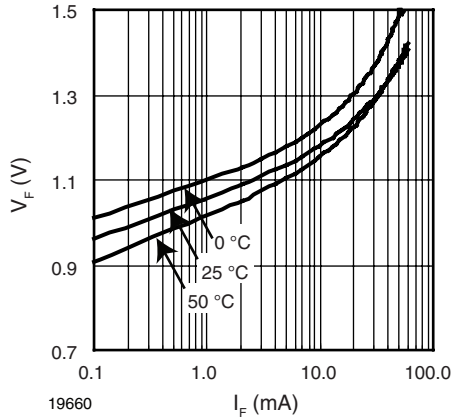

Fig. 2 - Diode Forward Voltage vs. Forward Current

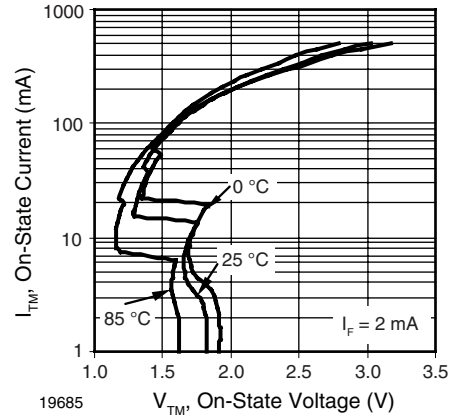

Fig. 5 - On-State Current vs. On-State Voltage

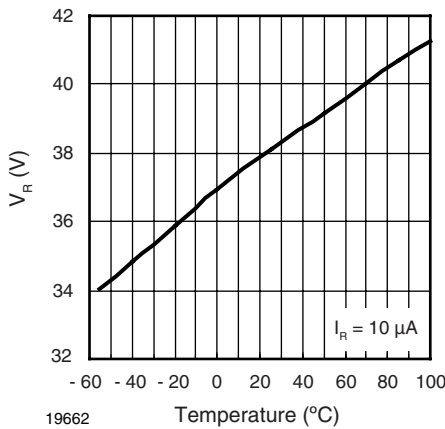

Fig. 3 - Diode Reverse Voltage vs. Temperature

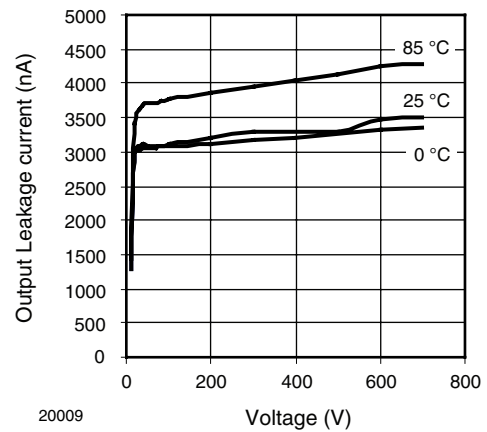

Fig. 6 - Output Off Current (Leakage) vs. Voltage

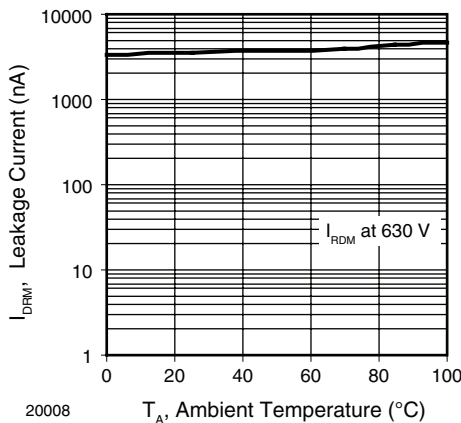

Fig. 4 - Leakage Current vs. Ambient Temperature

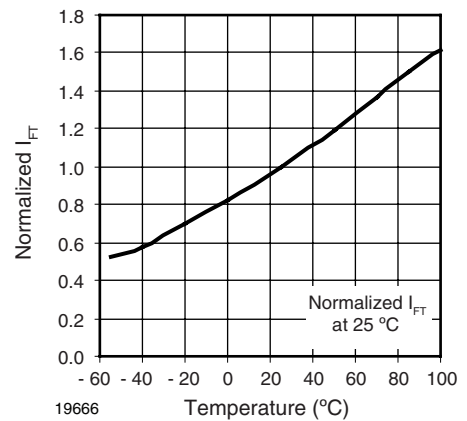

Fig. 7 - Normalized Trigger Input Current vs. Temperature

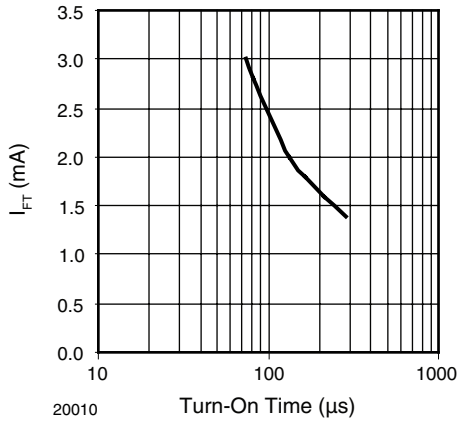

Fig. 8 - I_{FT} (mA) vs. Turn-On Time (μs)

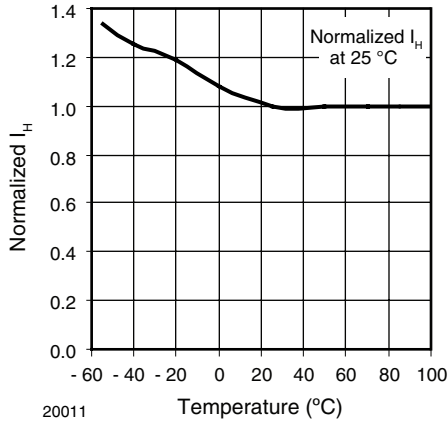

Fig. 9 - Normalized Holding Current vs. Temperature

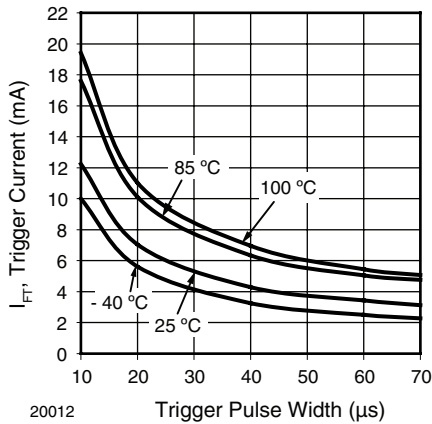

Fig. 10 - I_{FT} vs. LED Pulse Width



Optocoupler, Phototriac Output,
Zero Crossing, High dV/dt, Low
Input Current

Vishay Semiconductors

OZONE DEPLETING SUBSTANCES POLICY STATEMENT

It is the policy of Vishay Semiconductor GmbH to

1. Meet all present and future national and international statutory requirements.
2. Regularly and continuously improve the performance of our products, processes, distribution and operating systems with respect to their impact on the health and safety of our employees and the public, as well as their impact on the environment.

It is particular concern to control or eliminate releases of those substances into the atmosphere which are known as ozone depleting substances (ODSs).

The Montreal Protocol (1987) and its London Amendments (1990) intend to severely restrict the use of ODSs and forbid their use within the next ten years. Various national and international initiatives are pressing for an earlier ban on these substances.

Vishay Semiconductor GmbH has been able to use its policy of continuous improvements to eliminate the use of ODSs listed in the following documents.

1. Annex A, B and list of transitional substances of the Montreal Protocol and the London Amendments respectively.
2. Class I and II ozone depleting substances in the Clean Air Act Amendments of 1990 by the Environmental Protection Agency (EPA) in the USA
3. Council Decision 88/540/EEC and 91/690/EEC Annex A, B and C (transitional substances) respectively.

Vishay Semiconductor GmbH can certify that our semiconductors are not manufactured with ozone depleting substances and do not contain such substances.

We reserve the right to make changes to improve technical design
and may do so without further notice.

Parameters can vary in different applications. All operating parameters must be validated for each customer application by the customer. Should the buyer use Vishay Semiconductors products for any unintended or unauthorized application, the buyer shall indemnify Vishay Semiconductors against all claims, costs, damages, and expenses, arising out of, directly or indirectly, any claim of personal damage, injury or death associated with such unintended or unauthorized use.

Vishay Semiconductor GmbH, P.O.B. 3535, D-74025 Heilbronn, Germany



Disclaimer

All product specifications and data are subject to change without notice.

Vishay Intertechnology, Inc., its affiliates, agents, and employees, and all persons acting on its or their behalf (collectively, "Vishay"), disclaim any and all liability for any errors, inaccuracies or incompleteness contained herein or in any other disclosure relating to any product.

Vishay disclaims any and all liability arising out of the use or application of any product described herein or of any information provided herein to the maximum extent permitted by law. The product specifications do not expand or otherwise modify Vishay's terms and conditions of purchase, including but not limited to the warranty expressed therein, which apply to these products.

No license, express or implied, by estoppel or otherwise, to any intellectual property rights is granted by this document or by any conduct of Vishay.

The products shown herein are not designed for use in medical, life-saving, or life-sustaining applications unless otherwise expressly indicated. Customers using or selling Vishay products not expressly indicated for use in such applications do so entirely at their own risk and agree to fully indemnify Vishay for any damages arising or resulting from such use or sale. Please contact authorized Vishay personnel to obtain written terms and conditions regarding products designed for such applications.

Product names and markings noted herein may be trademarks of their respective owners.



**Стандарт
Электрон
Связь**

Мы молодая и активно развивающаяся компания в области поставок электронных компонентов. Мы поставляем электронные компоненты отечественного и импортного производства напрямую от производителей и с крупнейших складов мира.

Благодаря сотрудничеству с мировыми поставщиками мы осуществляем комплексные и плановые поставки широчайшего спектра электронных компонентов.

Собственная эффективная логистика и склад в обеспечивает надежную поставку продукции в точно указанные сроки по всей России.

Мы осуществляем техническую поддержку нашим клиентам и предпродажную проверку качества продукции. На все поставляемые продукты мы предоставляем гарантию .

Осуществляем поставки продукции под контролем ВП МО РФ на предприятия военно-промышленного комплекса России , а также работаем в рамках 275 ФЗ с открытием отдельных счетов в уполномоченном банке. Система менеджмента качества компании соответствует требованиям ГОСТ ISO 9001.

Минимальные сроки поставки, гибкие цены, неограниченный ассортимент и индивидуальный подход к клиентам являются основой для выстраивания долгосрочного и эффективного сотрудничества с предприятиями радиоэлектронной промышленности, предприятиями ВПК и научно-исследовательскими институтами России.

С нами вы становитесь еще успешнее!

Наши контакты:

Телефон: +7 812 627 14 35

Электронная почта: sales@st-electron.ru

Адрес: 198099, Санкт-Петербург,
Промышленная ул, дом № 19, литера Н,
помещение 100-Н Офис 331