

GPS LOW NOISE AMPLIFIER GaAs MMIC

■ GENERAL DESCRIPTION

The NJG1108HA8 is a low noise amplifier GaAs MMIC designed for GPS. This amplifier provides low noise figure, high gain and high IP3 operated by single low positive power supply. This IC has the function of Stand-by mode. This amplifier can be tuned to wide frequency point (1.5GHz~2.7GHz) by changing the external matching components.

An ultra-small and ultra-thin package of the USB6-A8 is adopted.

■ PACKAGE OUTLINE

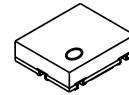

NJG1108HA8

■ FEATURES

- Low voltage operation +2.7V typ.
- Low current consumption 2.0mA typ. @ $V_{CTL}=1.85V$
- High gain 19dB typ. @ $V_{CTL}=0V$
- Low noise figure 1.0dB typ. @ $V_{CTL}=1.85V, f=1.575GHz$
- Input power at 1dB gain compression point -15.0dBm typ. @ $V_{CTL}=1.85V, f=1.575GHz$
- High input IP3 0dBm typ. @ $V_{CTL}=1.85V, f=1.575+1.5751GHz$
- Ultra-small and ultra-thin package USB6-A8 (Package size: 1.0x1.2x0.38mm)

■ PIN CONFIGURATION

(Top View)

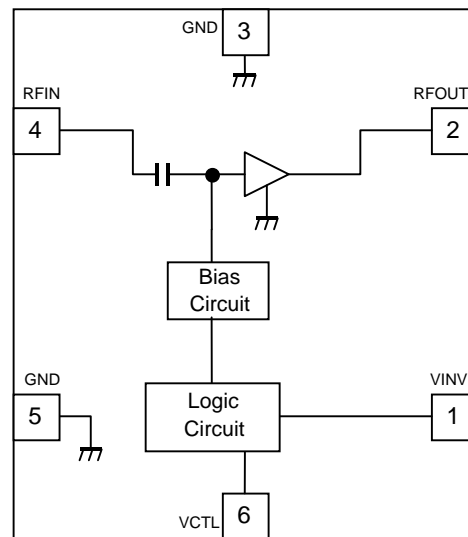

Pin Connection

1. VINV
2. RFOUT
3. GND
4. RFIN
5. GND
6. VCTL

■ TRUTH TABLE

“H”= $V_{CTL(H)}$, “L”= $V_{CTL(L)}$

V_{CTL}	LNA Mode
H	Active Mode
L	Sleep Mode

Note: Specifications and description listed in this datasheet are subject to change without notice.

NJG1108HA8

■ABSOLUTE MAXIMUM RATINGS

$T_a=+25^{\circ}\text{C}$, $Z_s=Z_l=50\text{ohm}$

PARAMETER	SYMBOL	CONDITIONS	RATINGS	UNITS
Drain Voltage	V_{DD}		5.0	V
Inverter voltage	V_{INV}		5.0	V
Control voltage	V_{CTL}		5.0	V
Input power	P_{in}	$V_{DD}=2.7\text{V}$	+15	dBm
Power dissipation	P_D	On PCB board, $T_{jmax}=150^{\circ}\text{C}$	150	mW
Operating temperature	T_{opr}		-40~+85	$^{\circ}\text{C}$
Storage temperature	T_{stg}		-55~+150	$^{\circ}\text{C}$

■ELECTRICAL CHARACTERISTICS 1

GENERAL CONDITIONS: $V_{DD}=V_{INV}=2.7\text{V}$, $T_a=+25^{\circ}\text{C}$, $Z_s=Z_l=50\text{ohm}$, with application circuit

PARAMETERS	SYMBOL	CONDITIONS	MIN	TYP	MAX	UNITS
Operating voltage	V_{DD}		2.5	2.7	3.5	V
Inverter supply voltage	V_{INV}		2.5	2.7	3.5	V
Control voltage (High)	$V_{CTL(H)}$		1.5	1.85	$V_{INV}+0.3$	V
Control voltage (Low)	$V_{CTL(L)}$		0	0	0.3	V
Operating current1 (Active Mode, RF OFF)	I_{DD1}	RF OFF, $V_{CTL}=1.85\text{V}$	-	2.0	3.0	mA
Operating current2 (Sleep Mode, RF OFF)	I_{DD2}	RF OFF, $V_{CTL}=0\text{V}$	-	1	5	μA
Inverter current1	I_{INV1}	RF OFF, $V_{CTL}=1.85\text{V}$	-	30	60	μA
Inverter current2	I_{INV2}	RF OFF, $V_{CTL}=0\text{V}$	-	9	20	μA
Control current	I_{CTL}	RF OFF, $V_{CTL}=1.85\text{V}$	-	6	20	μA

ELECTRICAL CHARACTERISTICS 2 (Active Mode)

GENERAL CONDITIONS: $V_{DD}=V_{INV}=2.7V$, $V_{CTL}=1.85V$, $f_{RF}=1575MHz$, $T_a=+25^{\circ}C$, $Z_s=Z_l=50ohm$, with application circuit

PARAMETERS	SYMBOL	CONDITIONS	MIN	TYP	MAX	UNITS
Operating Frequency	freq		1.57	1.575	1.58	GHz
Small signal gain	Gain		17.0	19.0	21.5	dB
Noise figure	NF	Exclude PCB & connector losses (IN: 0.05dB)	-	1.0	1.2	dB
Input power at 1dB gain compression point	$P_{-1dB(IN)}$		-19.0	-15.0	-	dBm
Input 3rd order intercept point	IIP3	$f1=f_{RF}$, $f2=f_{RF}+100kHz$, $Pin=-34dBm$	-5.0	0	-	dBm
RF IN VSWR	VSWR _i		-	2.0	2.5	
RF OUT VSWR	VSWR _o		-	1.5	2.0	

NJG1108HA8

■ TERMINAL INFORMATION

No.	SYMBOL	DESCRIPTION
1	VINV	Power supply pin of the inverter circuit.
2	RFOUT	RF Output and voltage supply pin. External matching circuits and a bypass capacitor is required. L3 is a RF choke inductor. These elements are used as output matching circuit.
3	GND	Ground pin. To keep good RF grounding performance, please use multiple via holes to connect with ground plane and this pin.)
4	RFIN	RF input pin. A DC blocking capacitor is not required. An external matching circuit is required.
5	GND	Ground pin. To keep good RF grounding performance, please use multiple via holes to connect with ground plane and this pin.)
6	VCTL	Control voltage input pin. This control pin is set to high. LNA suffers from standby state when LNA puts the changeover voltage of "Low" in a state of movement when the changeover voltage of "High" is put in this terminal.

CAUTION

1) Ground terminal (3, 5) should be connected to the ground plane as low inductance as possible.

■ ELECTRICAL CHARACTERISTICS

(Conditions: $V_{DD}=V_{INV}=2.7V$, $V_{CTL}=1.85V$, $f_{RF}=1575MHz$, $T_a=+25^\circ C$, $Z_s=Z_l=50\Omega$, with application circuit)

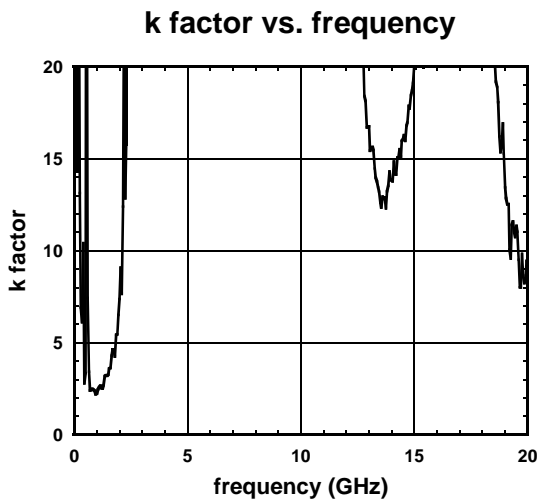
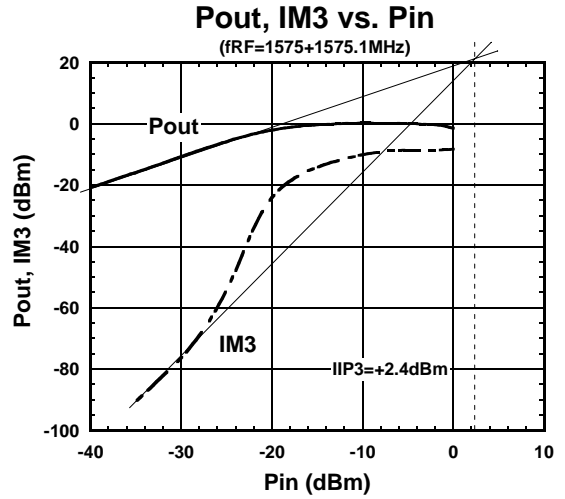
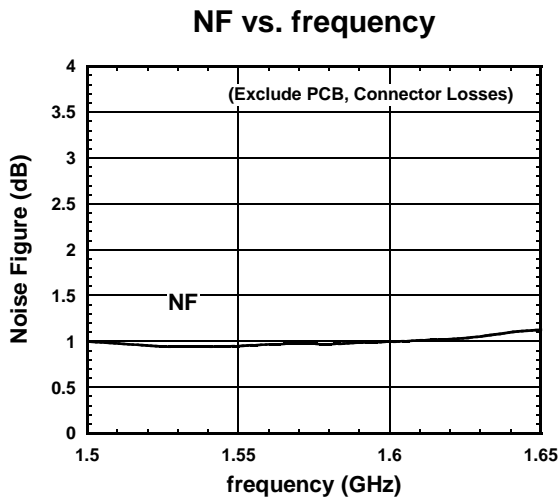
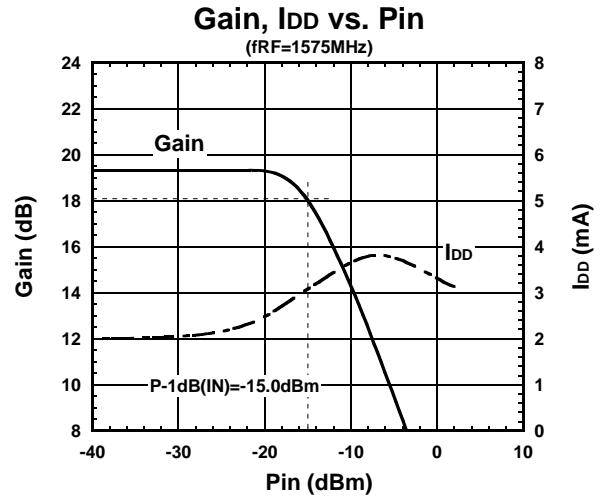
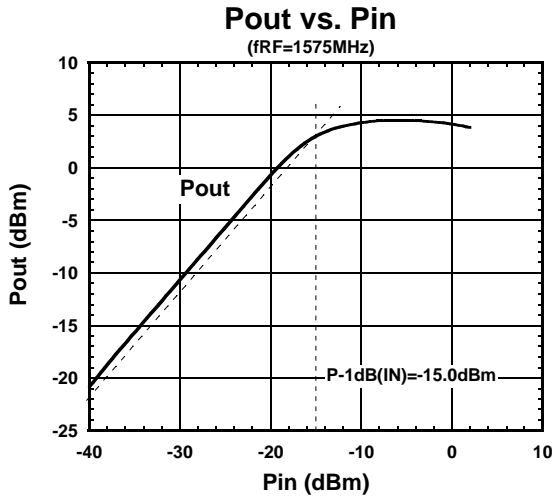

NJG1108HA8

ELECTRICAL CHARACTERISTICS

(Conditions: $V_{DD}=V_{INV}=2.7V$, $V_{CTL}=1.85V$, $f_{RF}=1575MHz$, $T_a=+25^\circ C$, $Z_s=Z_l=50\Omega$, with application circuit)

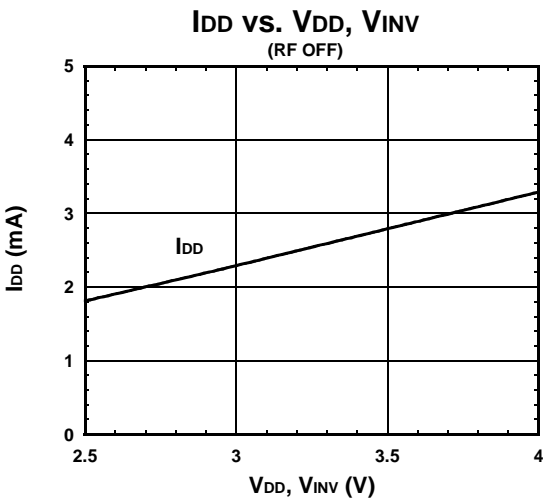
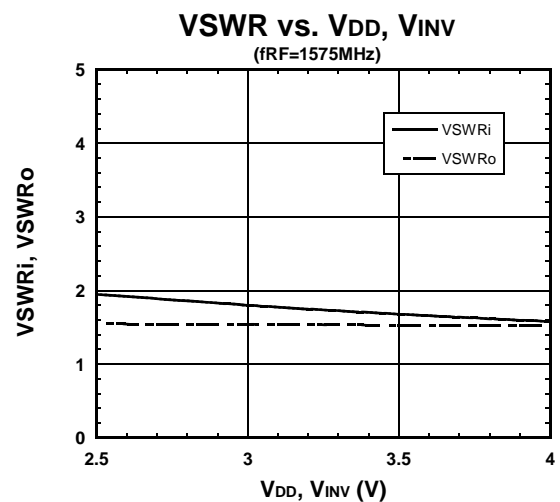
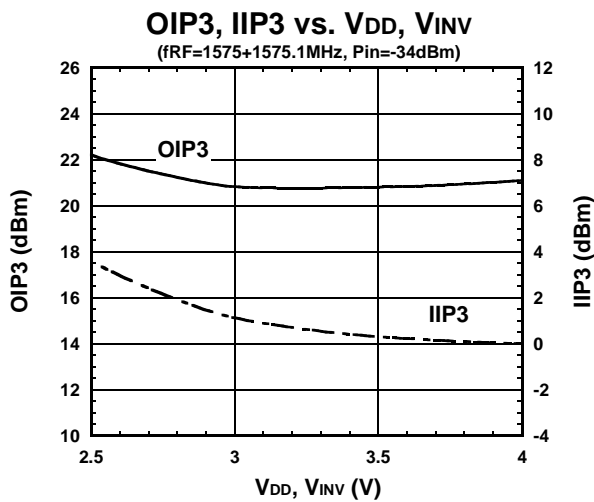
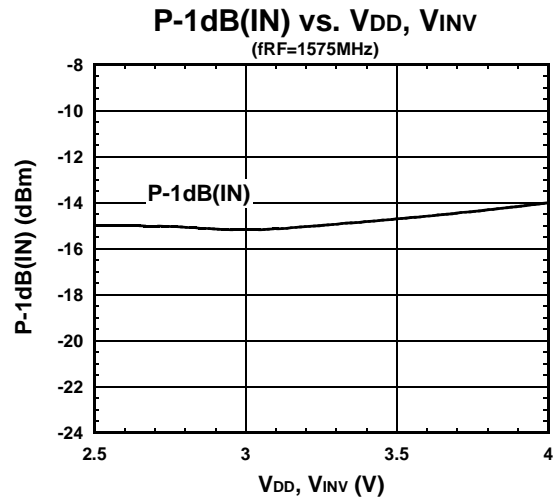
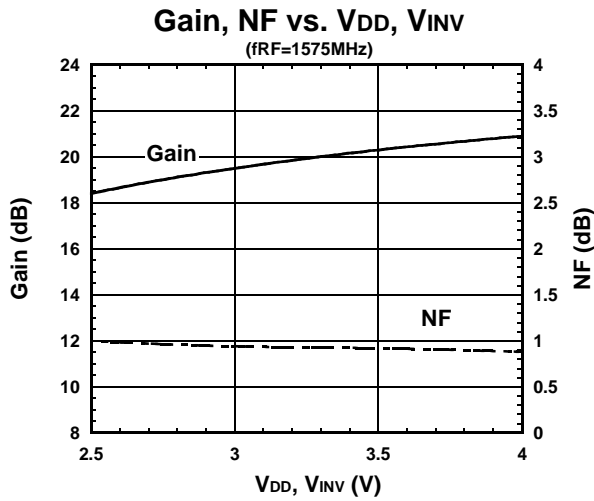

■ ELECTRICAL CHARACTERISTICS

(Conditions: $V_{DD}=V_{INV}=2.7V$, $V_{CTL}=1.85V$, $f_{RF}=1575MHz$, $T_a=+25^\circ C$, $Z_s=Z_i=50\Omega$, with application circuit)

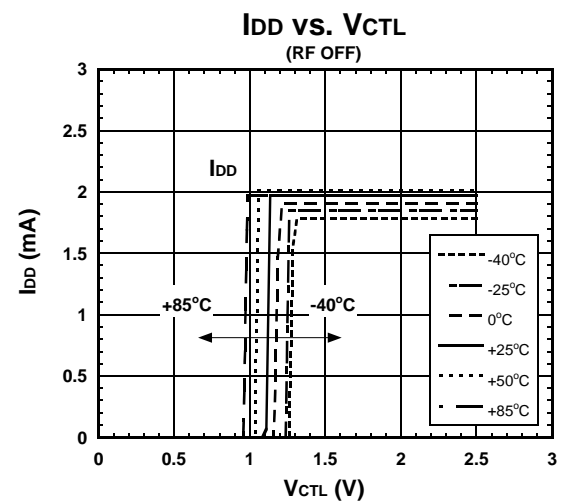
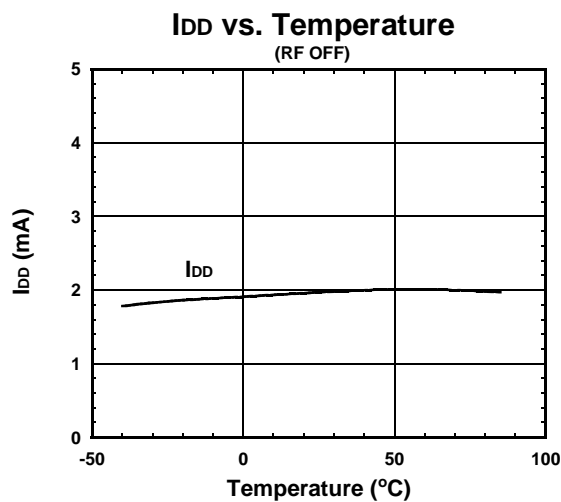
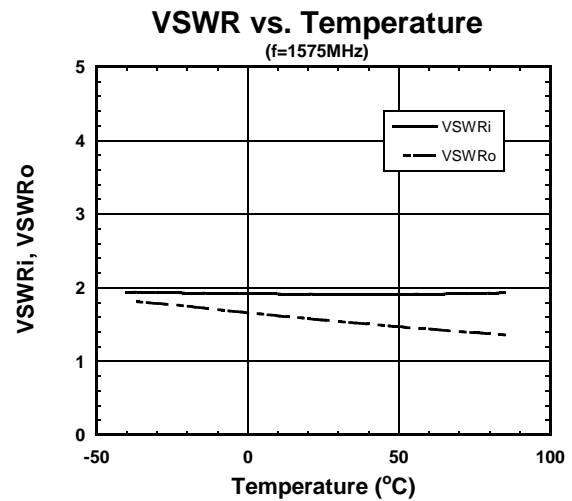
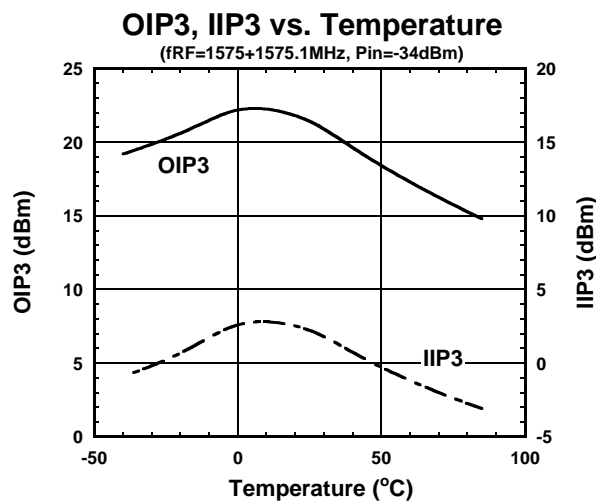
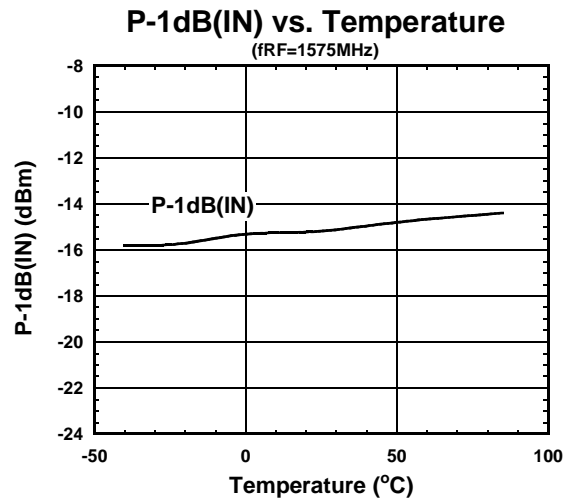
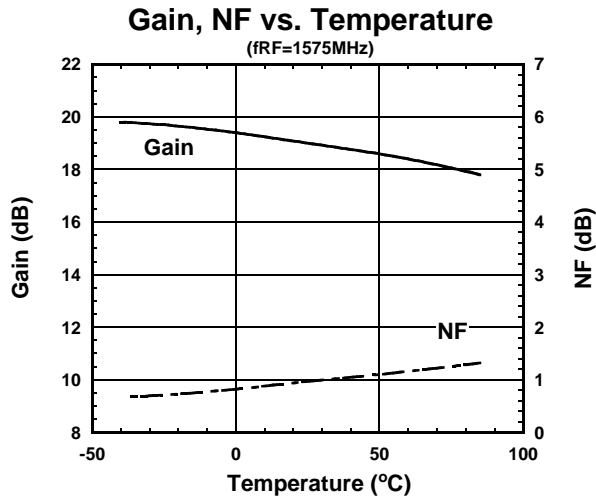

NJG1108HA8

ELECTRICAL CHARACTERISTICS

(Conditions: $V_{DD}=V_{INV}=2.7V$, $V_{CTL}=1.85V$, $f_{RF}=1575MHz$, $T_a=+25^\circ C$, $Z_s=Z_l=50\Omega$, with application circuit)

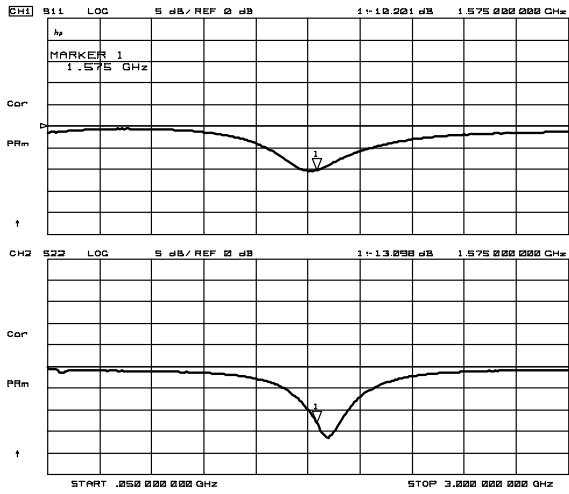

S11, S22

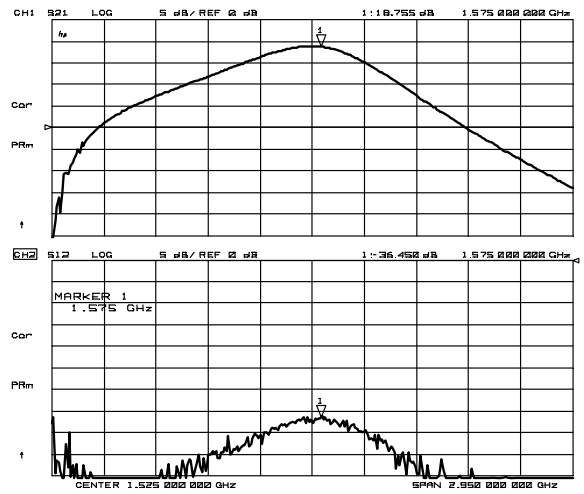

S21, S12

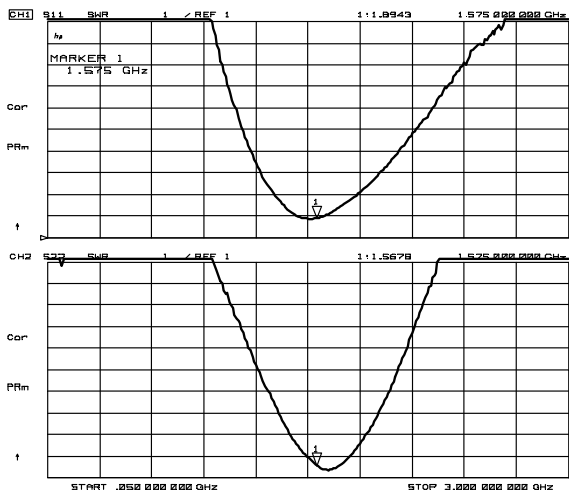

VSWR

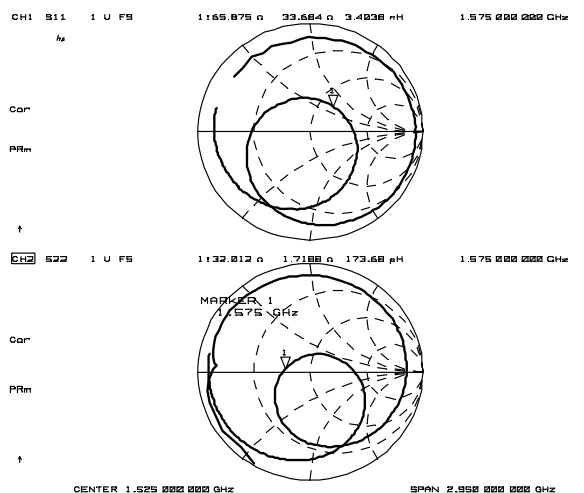

Zin, Zout

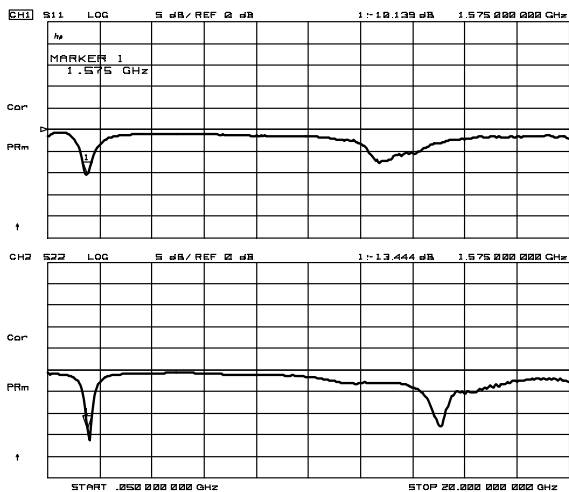

S11, S22 (f=50MHz~20GHz)

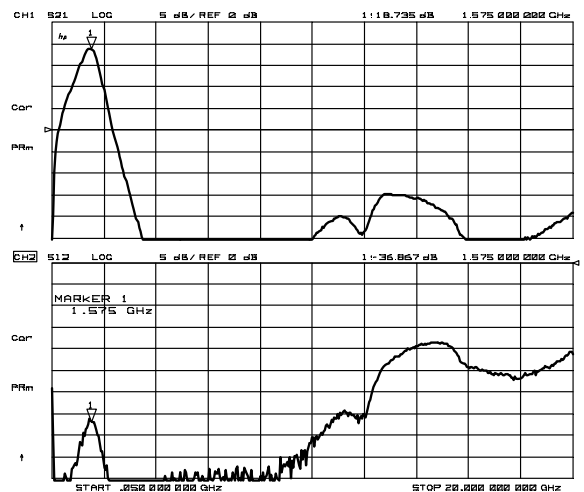

S21, S12 (f=50MHz~20GHz)

APPLICATION CIRCUIT

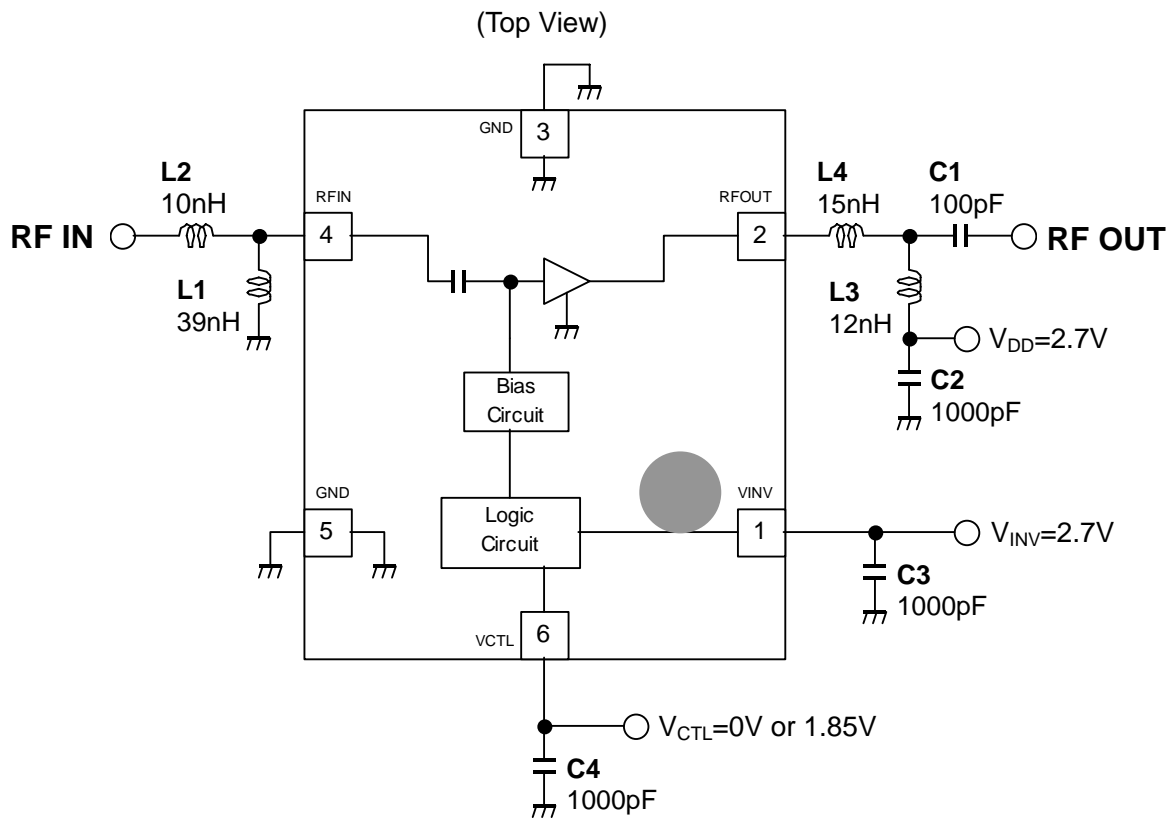

TEST PCB LAYOUT

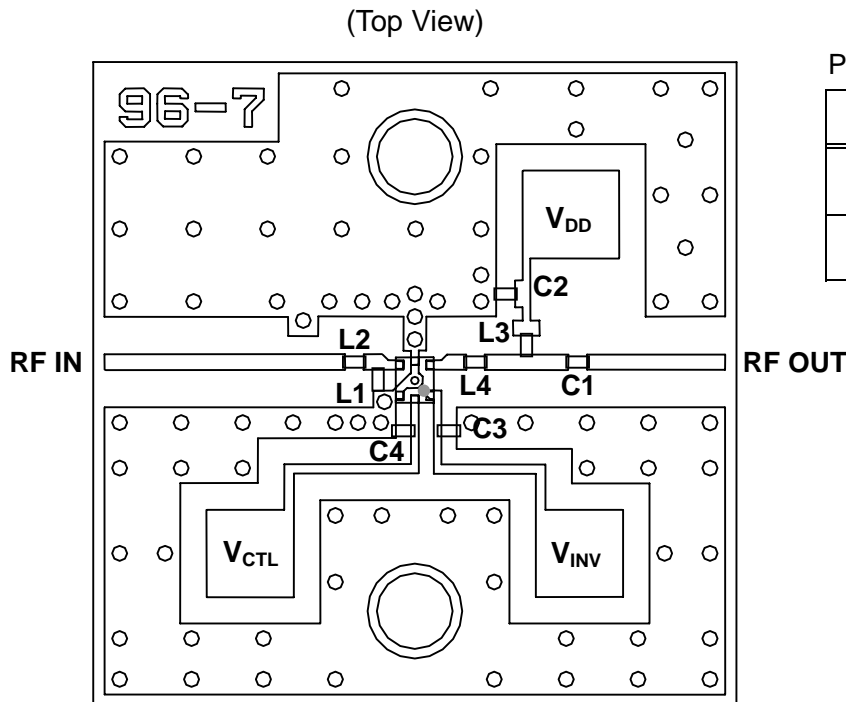

Parts List

Parts ID	Notes
L1~L4	MURATA (LQP03T series)
C1~C3	MURATA (GRM03 series)

PCB (FR-4): t=0.2mm
 MICROSTRIP LINE WIDTH
 =0.4mm ($Z_0=50\text{ohm}$)
 PCB SIZE=17.0mmx17.0mm

Mouser Electronics

Authorized Distributor

Click to View Pricing, Inventory, Delivery & Lifecycle Information:

[NJR:](#)

[NJG1108HA8-TE1](#)



Стандарт Электрон Связь

Мы молодая и активно развивающаяся компания в области поставок электронных компонентов. Мы поставляем электронные компоненты отечественного и импортного производства напрямую от производителей и с крупнейших складов мира.

Благодаря сотрудничеству с мировыми поставщиками мы осуществляем комплексные и плановые поставки широчайшего спектра электронных компонентов.

Собственная эффективная логистика и склад в обеспечивает надежную поставку продукции в точно указанные сроки по всей России.

Мы осуществляем техническую поддержку нашим клиентам и предпродажную проверку качества продукции. На все поставляемые продукты мы предоставляем гарантию .

Осуществляем поставки продукции под контролем ВП МО РФ на предприятия военно-промышленного комплекса России , а также работаем в рамках 275 ФЗ с открытием отдельных счетов в уполномоченном банке. Система менеджмента качества компании соответствует требованиям ГОСТ ISO 9001.

Минимальные сроки поставки, гибкие цены, неограниченный ассортимент и индивидуальный подход к клиентам являются основой для выстраивания долгосрочного и эффективного сотрудничества с предприятиями радиоэлектронной промышленности, предприятиями ВПК и научно-исследовательскими институтами России.

С нами вы становитесь еще успешнее!

Наши контакты:

Телефон: +7 812 627 14 35

Электронная почта: sales@st-electron.ru

Адрес: 198099, Санкт-Петербург,
Промышленная ул, дом № 19, литера Н,
помещение 100-Н Офис 331