

Overview

The KEMET Organic Capacitor (KO-CAP) is a tantalum capacitor with a Ta anode and Ta₂O₅ dielectric. A conductive organic polymer replaces the traditionally used MnO₂ as the cathode plate of the capacitor. This results in very low ESR and improved capacitance retention at high frequency. The KO-CAP also exhibits a benign failure mode which eliminates the ignition failures that can occur in standard MnO₂ tantalum types. KO-CAPs may also be operated at steady state voltages up to 90% of rated voltage for part types with rated voltages of

≤ 10 volts and up to 80% of rated voltage for part types > 10 volts with equivalent or better reliability than traditional MnO₂ tantalum capacitors operated at 50% of rated voltage. The T525 Series KO-CAP Low ESR Polymer is KEMET's 125°C rated tantalum polymer capacitor. This part offers the same advantages as the T520 Series such as low ESR, high frequency capacitance retention and a benign failure mode. The T525 Series is often the series of choice when considering automotive or industrial type applications.

Benefits

- Polymer cathode technology
- 125°C maximum operating temperature
- High frequency capacitance retention
- Non-ignition failure mode
- Capacitance: 33 µF to 680 µF
- Voltage: 2.5 V to 16 V
- Use up to 90% of rated voltage (10% derating) for part types ≤ 10 V
- Use up to 80% of rated voltage (20% derating) for part types > 10 V
- 100% surge current tested
- Self-healing mechanism
- Volumetrically efficient
- EIA standard case sizes
- RoHS Compliant and Halogen Free

Applications

Typical applications include automotive, industrial and military as per DSCC 04051.



Environmental Compliance

RoHS Compliant (6/6) according to Directive 2002/95/EC when ordered with 100% Sn solder.



RoHS Compliant

SPICE

For a detailed analysis of specific part numbers, please visit www.kemet.com for a free download of KEMET's SPICE software. The KEMET SPICE program is freeware intended to aid design engineers in analyzing the performance of these capacitors over frequency, temperature, ripple, and DC bias conditions.

Ordering Information

| T | 525 | D | 337 | M | 006 | A | T | E800 | |
|-----------------|---------------------------|---------------|--|-----------------------|--|---------------------|---|---|------------------------------------|
| Capacitor Class | Series | Case Size | Capacitance Code (pF) | Capacitance Tolerance | Voltage | Failure Rate/Design | Lead Material | ESR | Packaging (C-Spec) |
| T = Tantalum | 525 = 125°C Rated Polymer | B, D, T, V, Y | First two digits represent significant figures. Third digit specifies number of zeros. | M = ±20% | 2R5 = 2.5 V 003 = 3 V 004 = 4 V 006 = 6.3 V 010 = 10 V 016 = 16 V | A = N/A | T = 100% Matte Tin (Sn) Plated H = Tin/Lead (SnPb) Solder Coated (5% Pb minimum) | Last three digits specify ESR in mΩ. (800 = 800 mΩ) | Blank = 7" Reel 7280 = 13" Reel |

Performance Characteristics

| Item | Performance Characteristics |
|-------------------------|---|
| Operating Temperature | -55°C to 125°C |
| Rated Capacitance Range | 22 – 680 μF @ 120 Hz/25°C |
| Capacitance Tolerance | M Tolerance (20%) |
| Rated Voltage Range | 2.5 – 16 V |
| DF (120 Hz) | ≤ 10% |
| ESR (100 kHz) | Refer to Part Number Electrical Specification Table |
| Leakage Current | ≤ 0.1 CV (μA) at rated voltage after 5 minutes |

Qualification

| Test | Condition | Characteristics | | | | |
|----------------------------|---|-----------------|-----------------------------------|-------|----------|----------|
| Endurance | 125°C @ 2/3 rated voltage, 2,000 hours | Δ C/C | Within -20%/+10% of initial value | | | |
| | | DF | ≤ Initial Limit | | | |
| | | DCL | 2 x IL @ 125°C | | | |
| | | ESR | 2 x Initial Limit | | | |
| Storage Life | 125°C @ 0 volts, 2,000 hours | Δ C/C | Within -20%/+10% of initial value | | | |
| | | DF | Within initial limits | | | |
| | | DCL | Within 2.0 x initial limit | | | |
| | | ESR | Within initial limit | | | |
| Humidity | 60°C, 90% RH, 1,000 hours, No Load | Δ C/C | Within -5%/+35% of initial value | | | |
| | | DF | ≤ Initial Limit | | | |
| | | DCL | Within 3.0 x initial limit | | | |
| Temperature Stability | Extreme temperature exposure at a succession of continuous steps at +25°C, -55°C, +25°C, +85°C, +125°C, +25°C | +25°C | -55°C | +85°C | +125°C | |
| | | Δ C/C | IL* | ±20% | ±20% | ±30% |
| | | DF | IL | IL | 1.2 x IL | 1.5 x IL |
| Surge Voltage | 105°C, 1.32 x rated voltage, 33 Ω Resistance, 1,000 cycles | DCL | 10 x IL | | | |
| | | ESR | 10 x IL | | | |
| | | Δ C/C | Within -20%/+10% of initial value | | | |
| Mechanical Shock/Vibration | MIL-STD-202, Method 213, Condition I, 100 G peak. MIL-STD-202, Method 204, Condition D, 10 Hz to 2,000 Hz, 20 G peak | DF | Within initial limits | | | |
| | | DCL | Within initial limits | | | |
| | | Δ C/C | Within ±10% of initial value | | | |

*IL = Initial Limit

Electrical Characteristics

ESR vs. Frequency

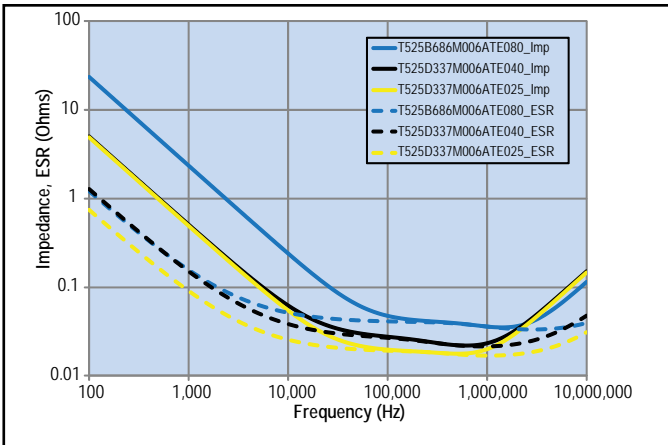

Capacitance vs. Frequency

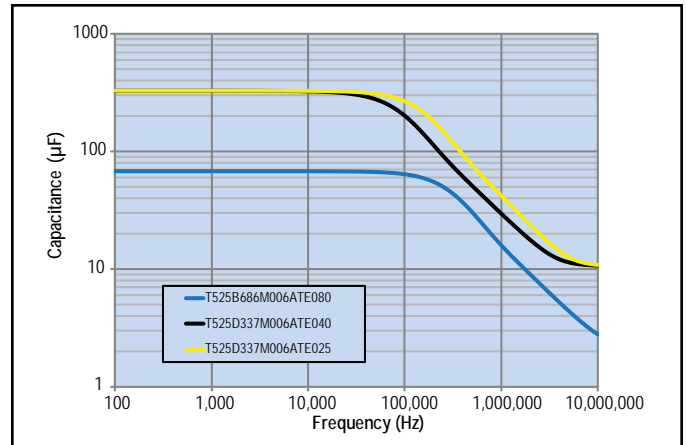

Dimensions – Millimeters (Inches)

Metric will govern

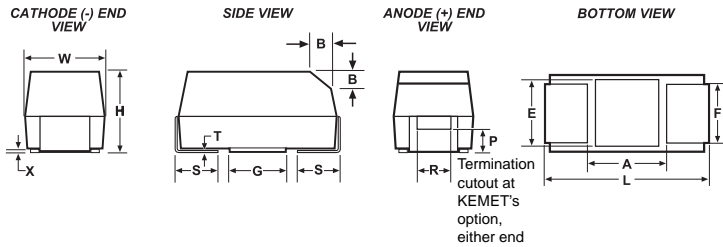

| Case Size | | Component | | | | | | | | | | | | |
|-----------|---------|----------------------------|----------------------------|----------------------------|--------------------|--------------------|-------------------------|------------------------------|------------|------------|-------------|------------|------------|------------|
| KEMET | EIA | L* | W* | H* | F* ±0.1 ±(.004) | S* ±0.3 ±(.012) | B* ±0.15 (Ref) ±.006 | X (Ref) | P (Ref) | R (Ref) | T (Ref) | A (Min) | G (Ref) | E (Ref) |
| B | 3528-21 | 3.5 ±0.2 (0.138 ±0.008) | 2.8 ±0.2 (0.110 ±0.008) | 1.9 ±0.2 (0.075 ±0.008) | 2.2 (.087) | 0.8 (.031) | 0.4 (.016) | 0.10 ± 0.10 (.004 ± .004) | 0.5 (.020) | 1.0 (.039) | 0.13 (.005) | 1.1 (.043) | 1.8 (.071) | 2.2 (.087) |
| D | 7343-31 | 7.3 ±0.3 (0.287 ±0.012) | 4.3 ±0.3 (0.169 ±0.012) | 2.8 ±0.3 (0.110 ±0.012) | 2.4 (.094) | 1.3 (.051) | 0.5 (.020) | 0.10 ± 0.10 (.004 ± .004) | 0.9 (.035) | 1.0 (.039) | 0.13 (.005) | 3.8 (.150) | 3.5 (.138) | 3.5 (.138) |
| T | 3528-12 | 3.5 ±0.2 (0.138 ±0.008) | 2.8 ±0.2 (0.110 ±0.008) | 1.2 (.047) | 2.2 (.087) | 0.8 (.031) | n/a | 0.05 (.002) | n/a | n/a | 0.13 (.005) | 1.1 (.043) | 1.8 (.071) | 2.2 (.087) |
| V | 7343-20 | 7.3 ±0.3 (0.287 ±0.012) | 4.3 ±0.3 (.169 ± .012) | 2.0 Maximum | 2.4 (.094) | 1.3 (.051) | n/a | 0.05 (.002) | n/a | n/a | 0.13 (.005) | 3.8 (.150) | 3.5 (.138) | 3.5 (.138) |
| Y | 7343-40 | 7.3 ±0.3 (0.287 ±0.012) | 4.3 ±0.3 (0.169 ±0.012) | 4.0 (.157) | 2.4 (.094) | 1.3 (.051) | 0.5 (.020) | 0.10 ± 0.10 (.004 ± .004) | 1.7 (.067) | 1.0 (.039) | 0.13 (.005) | 3.8 (.150) | 3.5 (.138) | 3.5 (.138) |

Notes: (Ref) – Dimensions provided for reference only. No dimensions are provided for B, P or R because low profile cases do not have a bevel or a notch.

* MIL-PRF-55365/8 specified dimensions

Table 1 – Ratings & Part Number Reference

| Rated Voltage | Rated Cap | Case Code/ Case Size | KEMET Part Number | DC Leakage | DF | ESR | Maximum Allowable Ripple Current | Moisture Sensitivity | Rated Temp |
|---------------|-----------|-------------------------|------------------------------|----------------------|----------------------|------------------------|----------------------------------|----------------------|------------|
| VDC | µF | KEMET/EIA | (See below for part options) | µA @ +20°C Max/5 Min | % @ +20°C 120 Hz Max | mΩ @ +20°C 100 kHz Max | (mA) 100 kHz +45°C | Temp ≤ 260°C | (°C) |
| 2.5 | 100 | T/3528-12 | T525T107M2R5A(1)E080 | 25.0 | 10 | 80 | 1100.0 | 3 | 125 |
| 2.5 | 330 | D/7343-31 | T525D337M2R5A(1)E025 | 82.5 | 10 | 25 | 3000.0 | 3 | 125 |
| 2.5 | 470 | D/7343-31 | T525D477M2R5A(1)E025 | 117.5 | 10 | 25 | 3000.0 | 3 | 125 |
| 2.5 | 680 | D/7343-31 | T525D687M2R5A(1)E025 | 170.0 | 10 | 25 | 3000.0 | 3 | 125 |
| 3 | 100 | B/3528-21 | T525B107M003A(1)E080 | 30.0 | 8 | 80 | 1300.0 | 3 | 125 |
| 3 | 150 | B/3528-21 | T525B157M003A(1)E080 | 45.0 | 8 | 80 | 1300.0 | 3 | 125 |
| 3 | 330 | D/7343-31 | T525D337M003A(1)E025 | 99.0 | 10 | 25 | 3000.0 | 3 | 125 |
| 3 | 470 | D/7343-31 | T525D477M003A(1)E025 | 141.0 | 10 | 25 | 3000.0 | 3 | 125 |
| 3 | 680 | D/7343-31 | T525D687M003A(1)E025 | 204.0 | 10 | 25 | 3000.0 | 3 | 125 |
| 4 | 68 | T/3528-12 | T525T686M004A(1)E080 | 27.2 | 8 | 80 | 1100.0 | 3 | 125 |
| 4 | 68 | B/3528-21 | T525B686M004A(1)E080 | 27.2 | 8 | 80 | 1300.0 | 3 | 125 |
| 4 | 100 | B/3528-21 | T525B107M004A(1)E080 | 40.0 | 8 | 80 | 1300.0 | 3 | 125 |
| 4 | 220 | D/7343-31 | T525D227M004A(1)E025 | 88.0 | 10 | 25 | 3000.0 | 3 | 125 |
| 4 | 330 | D/7343-31 | T525D337M004A(1)E025 | 132.0 | 10 | 25 | 3000.0 | 3 | 125 |
| 4 | 470 | D/7343-31 | T525D477M004A(1)E025 | 188.0 | 10 | 25 | 3000.0 | 3 | 125 |
| 4 | 470 | D/7343-31 | T525D477M004A(1)E040 | 188.0 | 10 | 40 | 2400.0 | 3 | 125 |
| 6.3 | 33 | B/3528-21 | T525B336M006A(1)E080 | 20.8 | 8 | 80 | 1300.0 | 3 | 125 |
| 6.3 | 47 | T/3528-12 | T525T476M006A(1)E080 | 29.6 | 8 | 80 | 1100.0 | 3 | 125 |
| 6.3 | 47 | B/3528-21 | T525B476M006A(1)E070 | 29.6 | 8 | 70 | 1300.0 | 3 | 125 |
| 6.3 | 47 | B/3528-21 | T525B476M006A(1)E080 | 29.6 | 8 | 80 | 1300.0 | 3 | 125 |
| 6.3 | 68 | B/3528-21 | T525B686M006A(1)E080 | 42.8 | 8 | 80 | 1300.0 | 3 | 125 |
| 6.3 | 150 | D/7343-31 | T525D157M006A(1)E025 | 94.5 | 10 | 25 | 3000.0 | 3 | 125 |
| 6.3 | 220 | D/7343-31 | T525D227M006A(1)E025 | 138.6 | 10 | 25 | 3000.0 | 3 | 125 |
| 6.3 | 330 | D/7343-31 | T525D337M006A(1)E025 | 207.9 | 10 | 25 | 3000.0 | 3 | 125 |
| 6.3 | 330 | D/7343-31 | T525D337M006A(1)E040 | 207.9 | 10 | 40 | 2400.0 | 3 | 125 |
| 6.3 | 470 | Y/7343-40 | T525Y477M006A(1)E035 | 296.1 | 10 | 35 | 2600.0 | 3 | 125 |
| 8 | 33 | T/3528-12 | T525T336M008A(1)E080 | 26.4 | 8 | 80 | 1100.0 | 3 | 125 |
| 10 | 22 | B/3528-21 | T525B226M010A(1)E080 | 22.0 | 8 | 80 | 1300.0 | 3 | 125 |
| 10 | 33 | T/3528-12 | T525T336M010A(1)E080 | 33.0 | 8 | 80 | 1100.0 | 3 | 125 |
| 10 | 33 | B/3528-21 | T525B336M010A(1)E080 | 33.0 | 8 | 80 | 1300.0 | 3 | 125 |
| 10 | 100 | D/7343-31 | T525D107M010A(1)E025 | 100.0 | 10 | 25 | 3000.0 | 3 | 125 |
| 10 | 100 | D/7343-31 | T525D107M010A(1)E055 | 100.0 | 10 | 55 | 2000.0 | 3 | 125 |
| 10 | 150 | D/7343-31 | T525D157M010A(1)E025 | 150.0 | 10 | 25 | 3000.0 | 3 | 125 |
| 10 | 150 | D/7343-31 | T525D157M010A(1)E055 | 150.0 | 10 | 55 | 2000.0 | 3 | 125 |
| 10 | 220 | D/7343-31 | T525D227M010A(1)E025 | 220.0 | 10 | 25 | 3000.0 | 3 | 125 |
| 10 | 330 | Y/7343-40 | T525Y337M010A(1)E035 | 330.0 | 10 | 35 | 2600.0 | 3 | 125 |
| 16 | 47 | D/7343-31 | T525D476M016A(1)E035 | 75.2 | 10 | 35 | 2500.0 | 3 | 125 |
| 16 | 47 | D/7343-31 | T525D476M016A(1)E065 | 75.2 | 10 | 65 | 1900.0 | 3 | 125 |
| VDC | µF | KEMET/EIA | (See below for part options) | µA @ +20°C Max/5 Min | % @ +20°C 120 Hz Max | mΩ @ +20°C 100 kHz Max | (mA) 100 kHz +45°C | Temp ≤ 260°C | (°C) |
| Rated Voltage | Rated Cap | Case Code/ Case Size | KEMET Part Number | DC Leakage | DF | ESR | Maximum Allowable Ripple Current | Moisture Sensitivity | Rated Temp |

(1) To complete KEMET part number, insert T = standard Tin terminations or H = Tin/lead terminations
 Refer to Ordering Information for additional detail.

Higher voltage ratings and tighter tolerance product including ESR may be substituted within the same size at KEMET's option. Voltage substitution will be marked with the higher voltage rating. Substitutions can include better than series.

Derating Guidelines

| Voltage Rating | Maximum Recommended Steady State Voltage | Maximum Recommended Transient Voltage (1ms – 1µs) |
|--------------------------------|--|---|
| -55°C to 105°C | | |
| 2.5 V ≤ V _R ≤ 10 V | 90% of V _R | V _R |
| 12.5 V ≤ V _R ≤ 16 V | 80% of V _R | V _R |
| 105°C to 125°C | | |
| 2.5 V ≤ V _R ≤ 10 V | 60% of V _R | 67% of V _R |
| 12.5 V ≤ V _R ≤ 16 V | 54% of V _R | 67% of V _R |

V_R = Rated Voltage

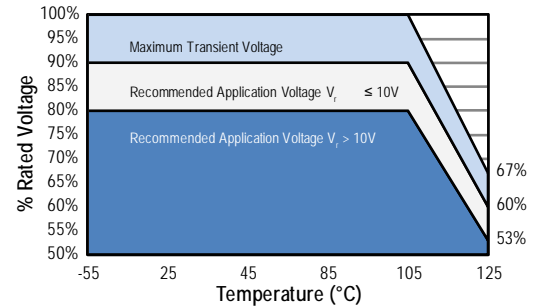

Ripple Current/Ripple Voltage

Permissible AC ripple voltage and current are related to equivalent series resistance (ESR) and the power dissipation capabilities of the device. Permissible AC ripple voltage which may be applied is limited by two criteria:

1. The positive peak AC voltage plus the DC bias voltage, if any, must not exceed the DC voltage rating of the capacitor.
2. The negative peak AC voltage in combination with bias voltage, if any, must not exceed the allowable limits specified for reverse voltage. See the Reverse Voltage section for allowable limits.

The maximum power dissipation by case size can be determined using the table at right. The maximum power dissipation rating stated in the table must be reduced with increasing environmental operating temperatures. Refer to the table below for temperature compensation requirements.

| Temperature Compensation Multipliers for Maximum Power Dissipation | | |
|--|------------------|------------------|
| ≤ 45°C | 45° C < T ≤ 85°C | 85°C < T ≤ 125°C |
| 1.00 | 0.70 | 0.25 |

T = Environmental Temperature

Using the P max of the device, the maximum allowable rms ripple current or voltage may be determined.

$$I(max) = \sqrt{P_{max}/R}$$

$$E(max) = \sqrt{P_{max} \cdot R}$$

I = rms ripple current (amperes)

E = rms ripple voltage (volts)

P max = maximum power dissipation (watts)

R = ESR at specified frequency (ohms)

| Case Code | EIA Case Code | Maximum Power Dissipation (P max) mWatts @ 45°C with +30°C Rise |
|-----------|---------------|---|
| T | 3528-12 | 105 |
| M | 3528-15 | 120 |
| A | 3216-18 | 112 |
| B | 3528-21 | 127 |
| U | 6032-15 | 135 |
| L | 6032-19 | 150 |
| C | 6032-28 | 165 |
| W | 7343-15 | 180 |
| V | 7343-20 | 187 |
| D | 7343-31 | 225 |
| Y | 7343-40 | 241 |
| X | 7343-43 | 247 |
| H | 7360-20 | 187 |
| I | 3216-10 | 95 |

The maximum power dissipation rating must be reduced with increasing environmental operating temperatures. Refer to the Temperature Compensation Multiplier table for details.

Reverse Voltage

Polymer tantalum capacitors are polar devices and may be permanently damaged or destroyed if connected in the wrong polarity. These devices will withstand a small degree of transient voltage reversal for short periods as shown in the below table.

| Temperature | Permissible Transient Reverse Voltage |
|-------------|---------------------------------------|
| 25°C | 15% of Rated Voltage |
| 55°C | 10% of Rated Voltage |
| 85°C | 5% of Rated Voltage |
| 105°C | 3% of Rated Voltage |
| 125°C* | 1% of Rated Voltage |

*For series rated to 125°C

Table 2 – Land Dimensions/Courtyard

| KEMET | Metric Size Code | Density Level A: Maximum (Most) Land Protrusion (mm) | | | | | Density Level B: Median (Nominal) Land Protrusion (mm) | | | | | Density Level C: Minimum (Least) Land Protrusion (mm) | | | | |
|----------------|------------------|--|------|------|-------|------|--|------|------|------|------|---|------|------|------|------|
| | | X | Y | C | V1 | V2 | X | Y | C | V1 | V2 | X | Y | C | V1 | V2 |
| B | 3528-21 | 2.35 | 2.15 | 1.45 | 6.10 | 4.00 | 2.25 | 1.75 | 1.35 | 5.00 | 3.50 | 2.15 | 1.35 | 1.25 | 4.10 | 3.20 |
| D | 7343-31 | 2.55 | 3.75 | 2.70 | 10.20 | 5.50 | 2.45 | 3.35 | 2.60 | 9.10 | 5.00 | 2.35 | 2.95 | 2.50 | 8.20 | 4.70 |
| T | 3528-12 | 2.35 | 2.15 | 1.45 | 6.10 | 4.00 | 2.25 | 1.75 | 1.35 | 5.00 | 3.50 | 2.15 | 1.35 | 1.25 | 4.10 | 3.20 |
| V | 7343-20 | 2.55 | 3.75 | 2.70 | 10.20 | 5.50 | 2.45 | 3.35 | 2.60 | 9.10 | 5.00 | 2.35 | 2.95 | 2.50 | 8.20 | 4.70 |
| Y ¹ | 7343-40 | 2.55 | 3.75 | 2.70 | 10.20 | 5.50 | 2.45 | 3.35 | 2.60 | 9.10 | 5.00 | 2.35 | 2.95 | 2.50 | 8.20 | 4.70 |

Density Level A: For low-density product applications. Recommended for wave solder applications and provides a wider process window for reflow solder processes.

Density Level B: For products with a moderate level of component density. Provides a robust solder attachment condition for reflow solder processes.

Density Level C: For high component density product applications. Before adapting the minimum land pattern variations the user should perform qualification testing based on the conditions outlined in IPC Standard 7351 (IPC-7351).

¹ Height of these chips may create problems in wave soldering.

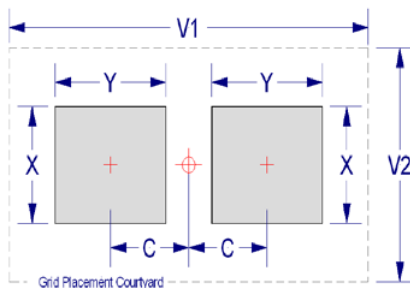

Soldering Process

KEMET’s families of surface mount capacitors are compatible with wave (single or dual), convection, IR, or vapor phase reflow techniques. Preheating of these components is recommended to avoid extreme thermal stress. KEMET’s recommended profile conditions for convection and IR reflow reflect the profile conditions of the IPC/J–STD–020D standard for moisture sensitivity testing. The devices can safely withstand a maximum of three reflow passes at these conditions.

Please note that although the X/7343–43 case size can withstand wave soldering, the tall profile (4.3 mm maximum) dictates care in wave process development.

Hand soldering should be performed with care due to the difficulty in process control. If performed, care should be taken to avoid contact of the soldering iron to the molded case. The iron should be used to heat the solder pad, applying solder between the pad and the termination, until reflow occurs. Once reflow occurs, the iron should be removed immediately. “Wiping” the edges of a chip and heating the top surface is not recommended.

During typical reflow operations, a slight darkening of the gold-colored epoxy may be observed. This slight darkening is normal and not harmful to the product. Marking permanency is not affected by this change.

| Profile Feature | SnPb Assembly | Pb-Free Assembly |
|---|---------------------|---------------------|
| Preheat/Soak | | |
| Temperature Minimum (T_{smin}) | 100°C | 150°C |
| Temperature Maximum (T_{smax}) | 150°C | 200°C |
| Time (t_s) from T_{smin} to T_{smax} | 60 – 120 seconds | 60 – 120 seconds |
| Ramp-up Rate (T_L to T_p) | 3°C/seconds maximum | 3°C/seconds maximum |
| Liquidous Temperature (T_L) | 183°C | 217°C |
| Time Above Liquidous (t_L) | 60 – 150 seconds | 60 – 150 seconds |
| Peak Temperature (T_p) | 220°C* 235°C** | 250°C* 260°C** |
| Time within 5°C of Maximum Peak Temperature (t_p) | 20 seconds maximum | 30 seconds maximum |
| Ramp-down Rate (T_p to T_L) | 6°C/seconds maximum | 6°C/seconds maximum |
| Time 25°C to Peak Temperature | 6 minutes maximum | 8 minutes maximum |

Note: All temperatures refer to the center of the package, measured on the package body surface that is facing up during assembly reflow.

*Case Size D, E, P, Y, and X

**Case Size A, B, C, H, I, K, M, R, S, T, U, V, W, and Z

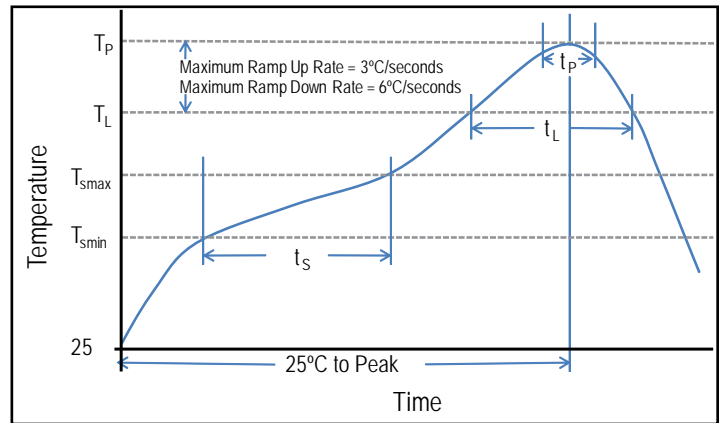

Construction

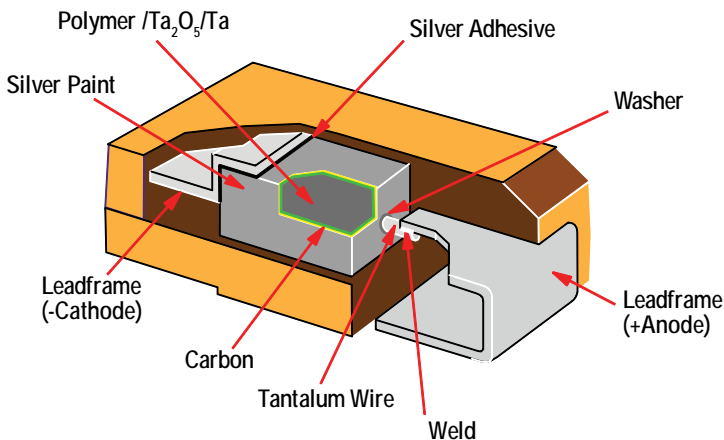

Capacitor Marking

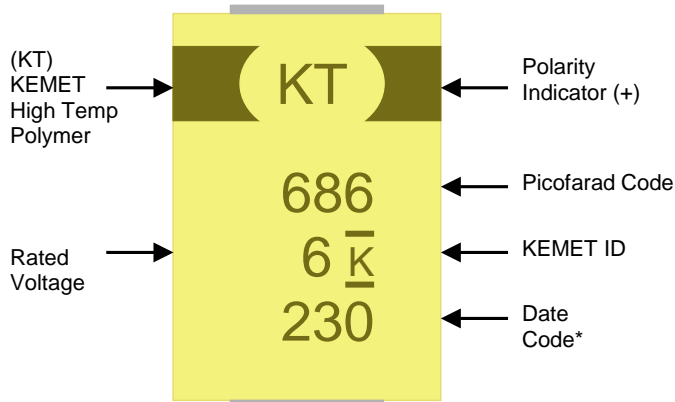

* 230 = 30th week of 2012

| Date Code * | |
|--|--|
| 1 st digit = Last number of Year | 9 = 2009 0 = 2010 1 = 2011 2 = 2012 3 = 2013 4 = 2014 |
| 2 nd and 3 rd digit = Week of the Year | 01 = 1 st week of the Year to 52 = 52 nd week of the Year |

Storage

All KO-CAP series are shipped in moisture barrier bags with a desiccant and moisture indicator card. These series are classified as MSL3 (Moisture Sensitivity Level 3). Product contained within the moisture barrier bags should be stored in normal working environments with temperatures not to exceed 40°C and humidity not in excess of 60% RH.

Tape & Reel Packaging Information

KEMET’s molded tantalum and aluminum chip capacitor families are packaged in 8 and 12 mm plastic tape on 7" and 13" reels in accordance with *EIA Standard 481-1: Embossed Carrier Taping of Surface Mount Components for Automatic Handling*. This packaging system is compatible with all tape-fed automatic pick-and-place systems.

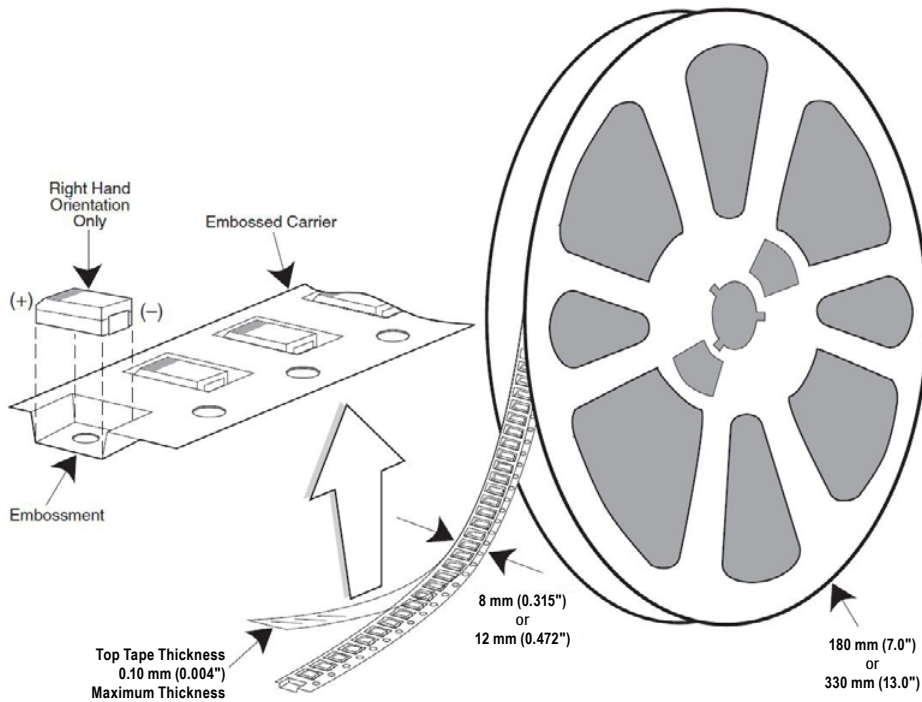

Table 3 – Packaging Quantity

| Case Code | | Tape Width (mm) | 7" Reel* | 13" Reel* |
|-----------|---------|-----------------|----------|-----------|
| KEMET | EIA | | | |
| I | 3216-10 | 8 | 3,000 | 12,000 |
| S | 3216-12 | 8 | 2,500 | 10,000 |
| T | 3528-12 | 8 | 2,500 | 10,000 |
| M | 3528-15 | 8 | 2,000 | 8,000 |
| U | 6032-15 | 12 | 1,000 | 5,000 |
| L | 6032-19 | 12 | 1,000 | 5,000 |
| W | 7343-15 | 12 | 1,000 | 3,000 |
| Z | 7343-17 | 12 | 1,000 | 3,000 |
| V | 7343-20 | 12 | 1,000 | 3,000 |
| A | 3216-18 | 8 | 2,000 | 9,000 |
| B | 3528-21 | 8 | 2,000 | 8,000 |
| C | 6032-28 | 12 | 500 | 3,000 |
| D | 7343-31 | 12 | 500 | 2,500 |
| Y | 7343-40 | 12 | 500 | 2,000 |
| X | 7343-43 | 12 | 500 | 2,000 |
| E/T428P | 7360-38 | 12 | 500 | 2,000 |
| H | 7360-20 | 12 | 1,000 | 2,500 |

* No C-Spec required for 7" reel packaging. C-7280 required for 13" reel packaging.

Figure 1 – Embossed (Plastic) Carrier Tape Dimensions

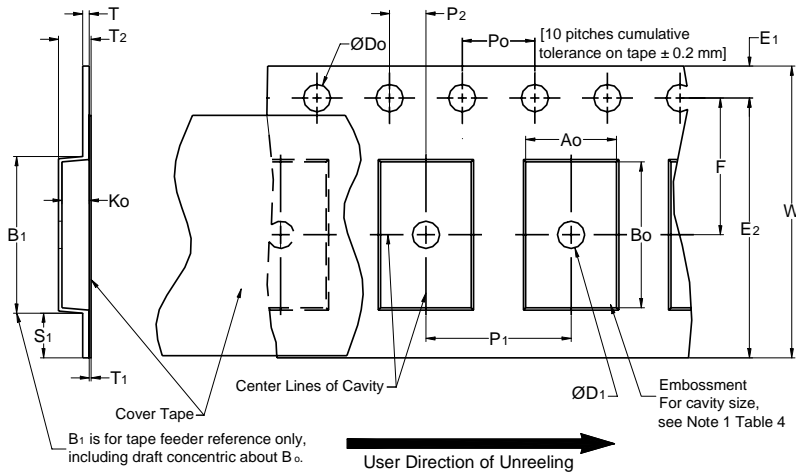

Table 4 – Embossed (Plastic) Carrier Tape Dimensions

Metric will govern

| Constant Dimensions — Millimeters (Inches) | | | | | | | | | |
|--|---------------------------------------|----------------------------------|------------------------------|-----------------------------|-----------------------------|------------------------|----------------------------------|--|------------------------|
| Tape Size | D ₀ | D ₁ Minimum Note 1 | E ₁ | P ₀ | P ₂ | R Reference Note 2 | S ₁ Minimum Note 3 | T Maximum | T ₁ Maximum |
| 8 mm | 1.5 +0.10/-0.0 (0.059 +0.004/-0.0) | 1.0 (0.039) | 1.75 ±0.10 (0.069 ±0.004) | 4.0 ±0.10 (0.157 ±0.004) | 2.0 ±0.05 (0.079 ±0.002) | 25.0 (0.984) | 0.600 (0.024) | 0.600 (0.024) | 0.100 (0.004) |
| 12 mm | | 1.5 (0.059) | | | | 30 (1.181) | | | |
| 16 mm | | | | | | | | | |
| Variable Dimensions — Millimeters (Inches) | | | | | | | | | |
| Tape Size | Pitch | B ₁ Maximum Note 4 | E ₂ Minimum | F | P ₁ | T ₂ Maximum | W Maximum | A ₀ , B ₀ & K ₀ | |
| 8 mm | Single (4 mm) | 4.35 (0.171) | 6.25 (0.246) | 3.5 ±0.05 (0.138 ±0.002) | 4.0 ±0.10 (0.157 ±0.004) | 2.5 (0.098) | 8.3 (0.327) | Note 5 | |
| 12 mm | Single (4 mm) & Double (8 mm) | 8.2 (0.323) | 10.25 (0.404) | 5.5 ±0.05 (0.217 ±0.002) | 8.0 ±0.10 (0.315 ±0.004) | 4.6 (0.181) | 12.3 (0.484) | | |
| 16 mm | Triple (12 mm) | 12.1 (0.476) | 14.25 (0.561) | 5.5 ±0.05 (0.217 ±0.002) | 8.0 ±0.10 (0.315 ±0.004) | 4.6 (0.181) | 16.3 (0.642) | | |

- The embossment hole location shall be measured from the sprocket hole controlling the location of the embossment. Dimensions of embossment location and hole location shall be applied independent of each other.
- The tape, with or without components, shall pass around R without damage (see Figure 5).
- If S₁ < 1.0 mm, there may not be enough area for cover tape to be properly applied (see EIA Standard 481–D, paragraph 4.3, section b).
- B₁ dimension is a reference dimension for tape feeder clearance only.
- The cavity defined by A₀, B₀ and K₀ shall surround the component with sufficient clearance that:
 - the component does not protrude above the top surface of the carrier tape.
 - the component can be removed from the cavity in a vertical direction without mechanical restriction, after the top cover tape has been removed.
 - rotation of the component is limited to 20° maximum for 8 and 12 mm tapes and 10° maximum for 16 mm tapes (see Figure 2).
 - lateral movement of the component is restricted to 0.5 mm maximum for 8 mm and 12 mm wide tape and to 1.0 mm maximum for 16 mm tape (see Figure 3).
 - see Addendum in EIA Standard 481–D for standards relating to more precise taping requirements.

Packaging Information Performance Notes

- 1. Cover Tape Break Force:** 1.0 Kg minimum.
- 2. Cover Tape Peel Strength:** The total peel strength of the cover tape from the carrier tape shall be:

| Tape Width | Peel Strength |
|--------------|----------------------------------|
| 8 mm | 0.1 to 1.0 Newton (10 to 100 gf) |
| 12 and 16 mm | 0.1 to 1.3 Newton (10 to 130 gf) |

The direction of the pull shall be opposite the direction of the carrier tape travel. The pull angle of the carrier tape shall be 165° to 180° from the plane of the carrier tape. During peeling, the carrier and/or cover tape shall be pulled at a velocity of 300 ±10 mm/minute.

- 3. Labeling:** Bar code labeling (standard or custom) shall be on the side of the reel opposite the sprocket holes. Refer to EIA Standards 556 and 624.

Figure 2 – Maximum Component Rotation

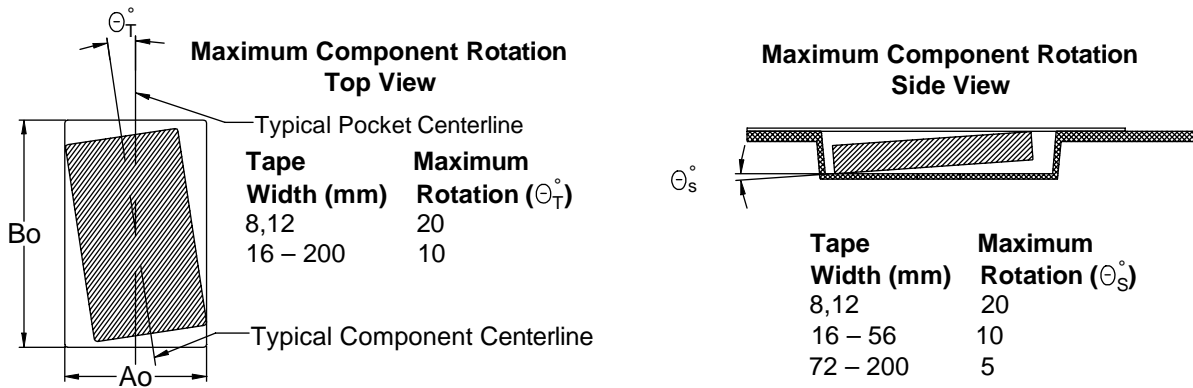

Figure 3 – Maximum Lateral Movement

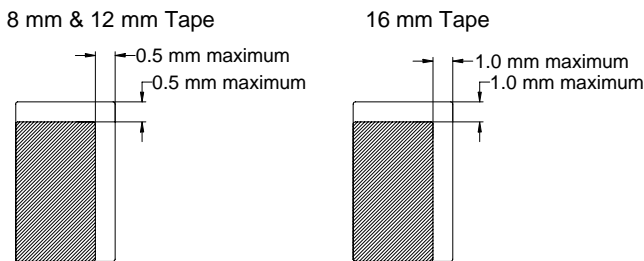

Figure 4 – Bending Radius

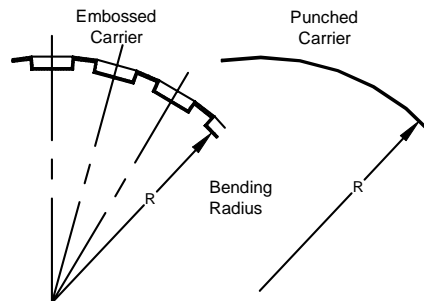
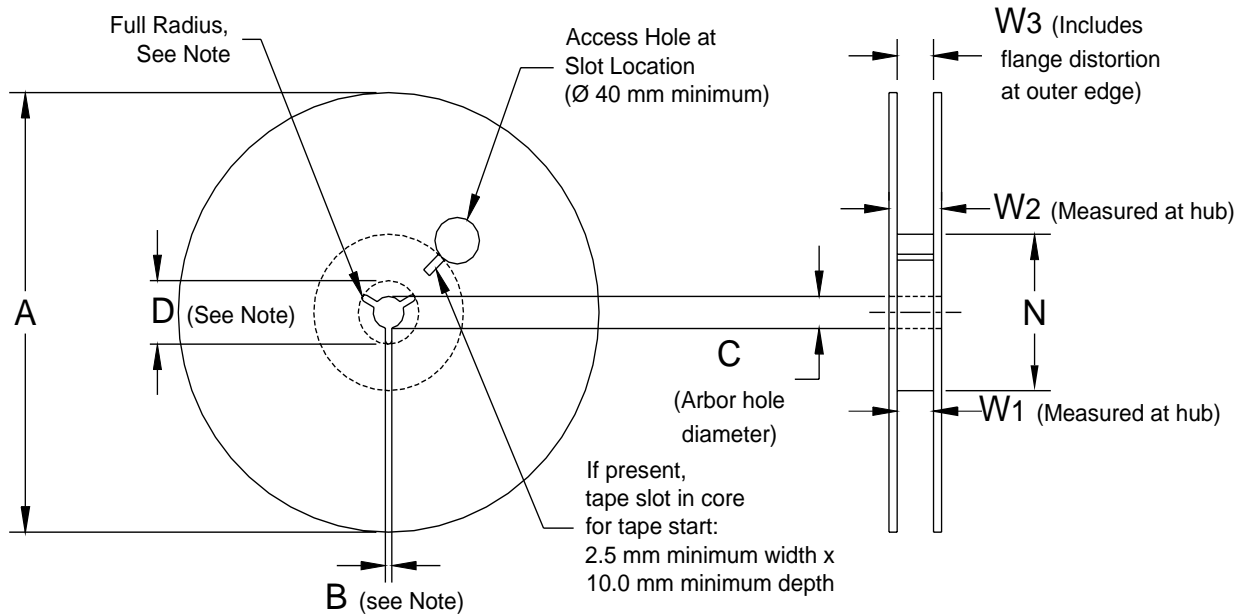

Figure 5 – Reel Dimensions



Note: Drive spokes optional; if used, dimensions B and D shall apply.

Table 5 – Reel Dimensions

Metric will govern

| Constant Dimensions — Millimeters (Inches) | | | | |
|--|---|---------------------------------------|--|---|
| Tape Size | A | B Minimum | C | D Minimum |
| 8 mm | 178 ±0.20 (7.008 ±0.008) or 330 ±0.20 (13.000 ±0.008) | 1.5 (0.059) | 13.0 +0.5/-0.2 (0.521 +0.02/-0.008) | 20.2 (0.795) |
| 12 mm | | | | |
| 16 mm | | | | |
| Variable Dimensions — Millimeters (Inches) | | | | |
| Tape Size | N Minimum | W ₁ | W ₂ Maximum | W ₃ |
| 8 mm | 50 (1.969) | 8.4 +1.5/-0.0 (0.331 +0.059/-0.0) | 14.4 (0.567) | Shall accommodate tape width without interference |
| 12 mm | | 12.4 +2.0/-0.0 (0.488 +0.078/-0.0) | 18.4 (0.724) | |
| 16 mm | | 16.4 +2.0/-0.0 (0.646 +0.078/-0.0) | 22.4 (0.882) | |

Figure 6 – Tape Leader & Trailer Dimensions

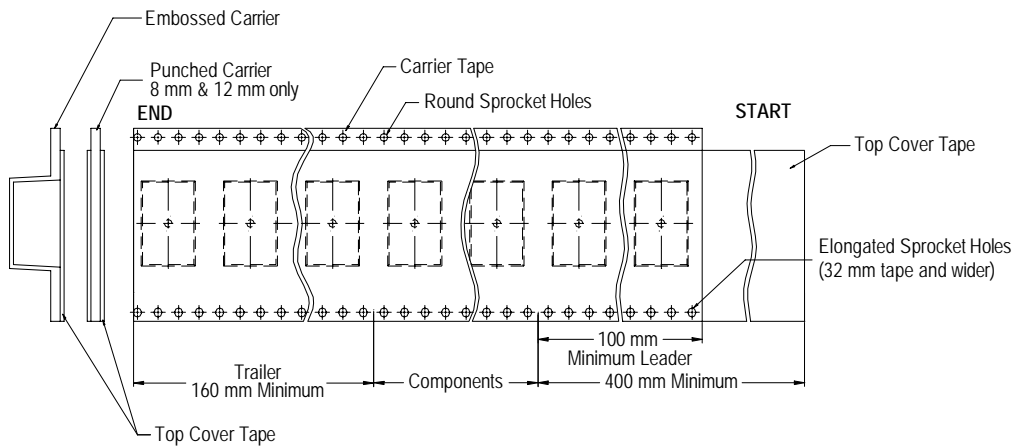
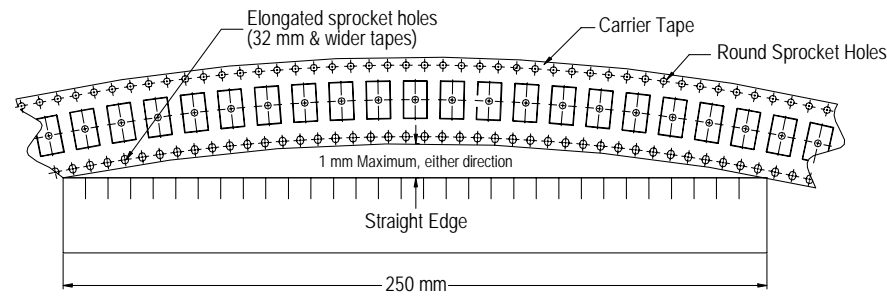

Figure 7 – Maximum Camber



KEMET Corporation World Headquarters

2835 KEMET Way
Simpsonville, SC 29681

Mailing Address:
P.O. Box 5928
Greenville, SC 29606

www.kemet.com
Tel: 864-963-6300
Fax: 864-963-6521

Corporate Offices
Fort Lauderdale, FL
Tel: 954-766-2800

North America

Southeast
Lake Mary, FL
Tel: 407-855-8886

Northeast
Wilmington, MA
Tel: 978-658-1663

Central
Novi, MI
Tel: 248-994-1030

West
Milpitas, CA
Tel: 408-433-9950

Mexico
Guadalajara, Jalisco
Tel: 52-33-3123-2141

Europe

Southern Europe
Paris, France
Tel: 33-1-4646-1006

Sasso Marconi, Italy
Tel: 39-051-939111

Central Europe
Landsberg, Germany
Tel: 49-8191-3350800

Kamen, Germany
Tel: 49-2307-438110

Northern Europe
Bishop's Stortford, United Kingdom
Tel: 44-1279-460122

Espoo, Finland
Tel: 358-9-5406-5000

Asia

Northeast Asia
Hong Kong
Tel: 852-2305-1168

Shenzhen, China
Tel: 86-755-2518-1306

Beijing, China
Tel: 86-10-5829-1711

Shanghai, China
Tel: 86-21-6447-0707

Taipei, Taiwan
Tel: 886-2-27528585

Southeast Asia
Singapore
Tel: 65-6586-1900

Penang, Malaysia
Tel: 60-4-6430200

Bangalore, India
Tel: 91-806-53-76817

Note: KEMET reserves the right to modify minor details of internal and external construction at any time in the interest of product improvement. KEMET does not assume any responsibility for infringement that might result from the use of KEMET Capacitors in potential circuit designs. KEMET is a registered trademark of KEMET Electronics Corporation.

Other KEMET Resources

| Tools | |
|--------------------------------|---|
| Resource | Location |
| Configure A Part: CapEdge | http://capacitoredge.kemet.com |
| SPICE & FIT Software | http://www.kemet.com/spice |
| Search Our FAQs: KnowledgeEdge | http://www.kemet.com/keask |
| Electrolytic LifeCalculator | http://www.kemet.com:8080/elc |

| Product Information | |
|--|---|
| Resource | Location |
| Products | http://www.kemet.com/products |
| Technical Resources (Including Soldering Techniques) | http://www.kemet.com/technicalpapers |
| RoHS Statement | http://www.kemet.com/rohs |
| Quality Documents | http://www.kemet.com/qualitydocuments |

| Product Request | |
|-------------------------|---|
| Resource | Location |
| Sample Request | http://www.kemet.com/sample |
| Engineering Kit Request | http://www.kemet.com/kits |

| Contact | |
|--------------------|---|
| Resource | Location |
| Website | www.kemet.com |
| Contact Us | http://www.kemet.com/contact |
| Investor Relations | http://www.kemet.com/ir |
| Call Us | 1-877-MyKEMET |
| Twitter | http://twitter.com/kemetcapacitors |

Disclaimer

All product specifications, statements, information and data (collectively, the "Information") are subject to change without notice.

All Information given herein is believed to be accurate and reliable, but is presented without guarantee, warranty, or responsibility of any kind, expressed or implied.

Statements of suitability for certain applications are based on our knowledge of typical operating conditions for such applications, but are not intended to constitute – and we specifically disclaim – any warranty concerning suitability for a specific customer application or use. This Information is intended for use only by customers who have the requisite experience and capability to determine the correct products for their application. Any technical advice inferred from this Information or otherwise provided by us with reference to the use of our products is given gratis, and we assume no obligation or liability for the advice given or results obtained.

Although we design and manufacture our products to the most stringent quality and safety standards, given the current state of the art, isolated component failures may still occur. Accordingly, customer applications which require a high degree of reliability or safety should employ suitable designs or other safeguards (such as installation of protective circuitry or redundancies) in order to ensure that the failure of an electrical component does not result in a risk of personal injury or property damage.

Although all product-related warnings, cautions and notes must be observed, the customer should not assume that all safety measures are indicated or that other measures may not be required.



Стандарт Электрон Связь

Мы молодая и активно развивающаяся компания в области поставок электронных компонентов. Мы поставляем электронные компоненты отечественного и импортного производства напрямую от производителей и с крупнейших складов мира.

Благодаря сотрудничеству с мировыми поставщиками мы осуществляем комплексные и плановые поставки широчайшего спектра электронных компонентов.

Собственная эффективная логистика и склад в обеспечивает надежную поставку продукции в точно указанные сроки по всей России.

Мы осуществляем техническую поддержку нашим клиентам и предпродажную проверку качества продукции. На все поставляемые продукты мы предоставляем гарантию .

Осуществляем поставки продукции под контролем ВП МО РФ на предприятия военно-промышленного комплекса России , а также работаем в рамках 275 ФЗ с открытием отдельных счетов в уполномоченном банке. Система менеджмента качества компании соответствует требованиям ГОСТ ISO 9001.

Минимальные сроки поставки, гибкие цены, неограниченный ассортимент и индивидуальный подход к клиентам являются основой для выстраивания долгосрочного и эффективного сотрудничества с предприятиями радиоэлектронной промышленности, предприятиями ВПК и научно-исследовательскими институтами России.

С нами вы становитесь еще успешнее!

Наши контакты:

Телефон: +7 812 627 14 35

Электронная почта: sales@st-electron.ru

Адрес: 198099, Санкт-Петербург,
Промышленная ул, дом № 19, литера Н,
помещение 100-Н Офис 331