



Is Now Part of



ON Semiconductor®

To learn more about ON Semiconductor, please visit our website at
www.onsemi.com

Please note: As part of the Fairchild Semiconductor integration, some of the Fairchild orderable part numbers will need to change in order to meet ON Semiconductor's system requirements. Since the ON Semiconductor product management systems do not have the ability to manage part nomenclature that utilizes an underscore (_), the underscore (_) in the Fairchild part numbers will be changed to a dash (-). This document may contain device numbers with an underscore (_). Please check the ON Semiconductor website to verify the updated device numbers. The most current and up-to-date ordering information can be found at www.onsemi.com. Please email any questions regarding the system integration to Fairchild_questions@onsemi.com.

ON Semiconductor and the ON Semiconductor logo are trademarks of Semiconductor Components Industries, LLC dba ON Semiconductor or its subsidiaries in the United States and/or other countries. ON Semiconductor owns the rights to a number of patents, trademarks, copyrights, trade secrets, and other intellectual property. A listing of ON Semiconductor's product/patent coverage may be accessed at www.onsemi.com/site/pdf/Patent-Marking.pdf. ON Semiconductor reserves the right to make changes without further notice to any products herein. ON Semiconductor makes no warranty, representation or guarantee regarding the suitability of its products for any particular purpose, nor does ON Semiconductor assume any liability arising out of the application or use of any product or circuit, and specifically disclaims any and all liability, including without limitation special, consequential or incidental damages. Buyer is responsible for its products and applications using ON Semiconductor products, including compliance with all laws, regulations and safety requirements or standards, regardless of any support or applications information provided by ON Semiconductor. "Typical" parameters which may be provided in ON Semiconductor data sheets and/or specifications can and do vary in different applications and actual performance may vary over time. All operating parameters, including "Typicals" must be validated for each customer application by customer's technical experts. ON Semiconductor does not convey any license under its patent rights nor the rights of others. ON Semiconductor products are not designed, intended, or authorized for use as a critical component in life support systems or any FDA Class 3 medical devices or medical devices with a same or similar classification in a foreign jurisdiction or any devices intended for implantation in the human body. Should Buyer purchase or use ON Semiconductor products for any such unintended or unauthorized application, Buyer shall indemnify and hold ON Semiconductor and its officers, employees, subsidiaries, affiliates, and distributors harmless against all claims, costs, damages, and expenses, and reasonable attorney fees arising out of, directly or indirectly, any claim of personal injury or death associated with such unintended or unauthorized use, even if such claim alleges that ON Semiconductor was negligent regarding the design or manufacture of the part. ON Semiconductor is an Equal Opportunity/Affirmative Action Employer. This literature is subject to all applicable copyright laws and is not for resale in any manner.



FAN7080_GF085 Half Bridge Gate Driver

Features

- Automotive Qualified to AEC Q100
- Floating Channel for Bootstrap Operation to +600 V
- Tolerance to Negative Transient Voltage on VS Pin
- VS-pin dv/dt Immune
- Gate Drive Supply Range from 5.5 V to 20 V
- Under-Voltage Lockout (UVLO)
- CMOS Schmitt-triggered Inputs with Pull-down
- High Side Output In-phase with Input
- IN input is 3.3 V/5 V Logic Compatible and Available on 15 V Input
- Matched Propagation Delay for both Channels
- Dead Time Adjustable

Applications

- Junction Box
 - Half and full bridge application in the motor drive system
- Related Product Resources

Description

The FAN7080_GF085 is a half-bridge gate drive IC with reset input and adjustable dead time control. It is designed for high voltage and high speed driving of MOSFET or IGBT, which operates up to 600 V. Fairchild's high-voltage process and common-mode noise cancellation technique provide stable operation in the high side driver under high-dV/dt noise circumstances. An advanced level-shift circuit allows high-side gate driver operation up to $V_S = -5$ V (typical) at $V_{BS} = 15$ V. Logic input is compatible with standard CMOS outputs. The UVLO circuits for both channels prevent from malfunction when V_{CC} and V_{BS} are lower than the specified threshold voltage. Combined pin function for dead time adjustment and reset shutdown make this IC packaged with space saving SOIC-8 Package. Minimum source and sink current capability of output driver is 250 mA and 500 mA respectively, which is suitable for junction box application and half and full bridge application in the motor drive system.

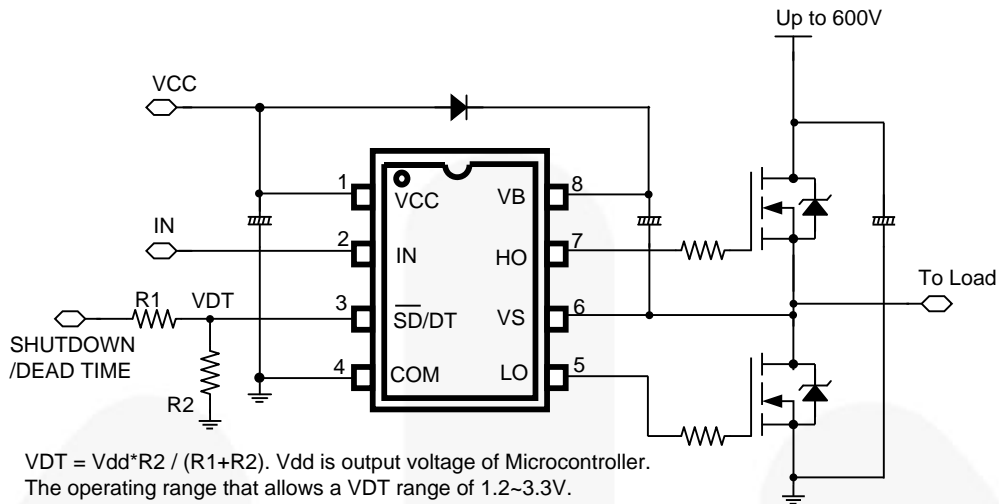

Figure 1. 8-Lead, SOIC, Narrow Body

Ordering Information

Part Number	Operating Temperature Range	Package	Packing Method
FAN7080M_GF085	-40°C ~ 125°C	8-Lead, Small Outline Integrated Circuit (SOIC), JEDEC MS-012, .150 inch Narrow Body	Tube
FAN7080MX_GF085			Tape & Reel

Typical Application



$VDT = Vdd * R2 / (R1 + R2)$. Vdd is output voltage of Microcontroller.
 The operating range that allows a VDT range of 1.2~3.3V.
 When pulled lower than VDT [Typ. 0.5V] the device is shutdown.
 Care must be taken to avoid below threshold spikes on pin 3 that can cause undesired shut down of the IC.
 For this reason the connection of the components between pin 3 and ground has to be as short as possible.
 And a capacitor (Typ. 0.02 μ F) between pin3 and COM can prevent this spike. This pin can not be left floating for the same reason.

Figure 2. Typical Application

Block Diagram

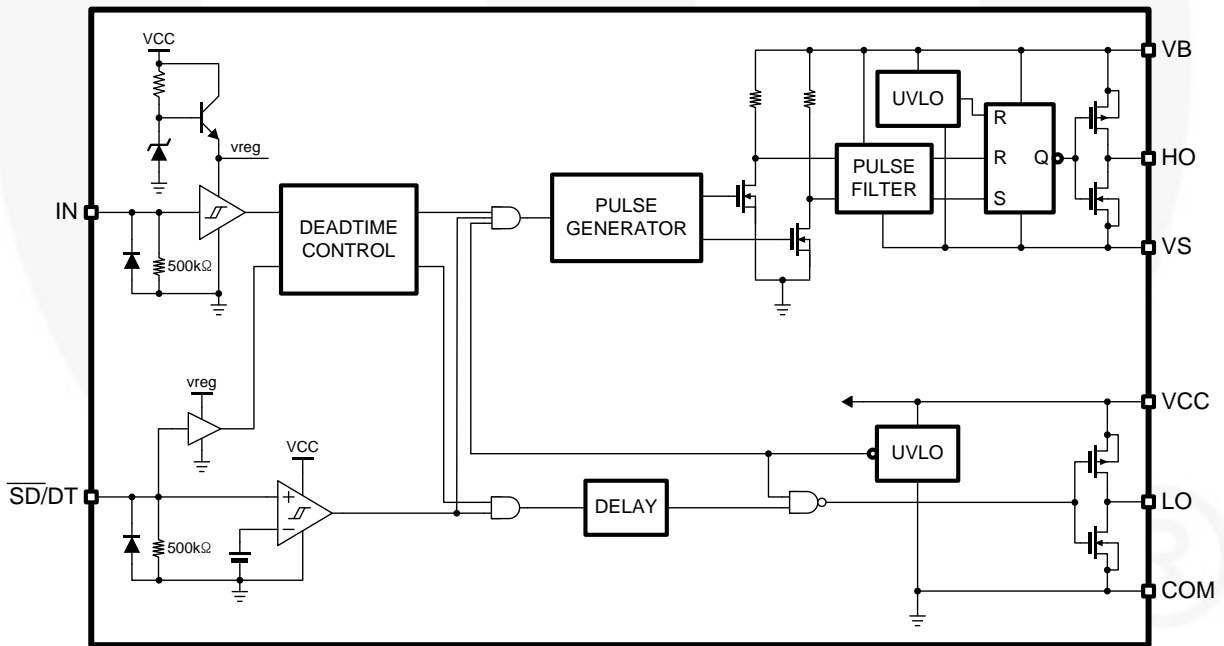

Figure 3. Block Diagram

Pin Configuration

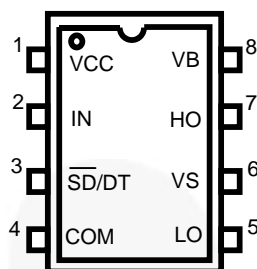

Figure 4. Pin Assignment (Top Through View)

Pin Descriptions

Pin #	Name	I/O	Pin Function Description
1	V _{CC}	P	Driver Supply Voltage
2	IN	I	Logic input for high and low side gate drive output
3	$\overline{\text{SD/DT}}$	I	Shutdown Input and dead time setting
4	COM	P	Ground
5	LO	A	Low side gate drive output for MOSFET Gate connection
6	V _S	A	High side floating offset for MOSFET Source connection
7	HO	A	High side drive output for MOSFET Gate connection
8	V _B	P	Driver Output Stage Supply

Absolute Maximum Ratings

Stresses exceeding the absolute maximum ratings may damage the device. The device may not function or be operable above the recommended operating conditions and stressing the parts to these levels is not recommended. In addition, extended exposure to stresses above the recommended operating conditions may affect device reliability. The absolute maximum ratings are stress ratings only.

Symbol	Parameter	Min.	Max.	Unit
V_S	High-Side Floating Offset Voltage	V_B-25	$V_B+0.3$	V
V_B	High-Side Floating Supply Voltage	-0.3	625	V
V_{HO}	High-Side Floating Output Voltage	$V_S-0.3$	$V_B+0.3$	V
V_{LO}	Low-Side Floating Output Voltage	-0.3	$V_{CC}+0.3$	V
V_{CC}	Supply Voltage	-0.3	25	V
V_{IN}	Input Voltage for IN	-0.3	$V_{CC}+0.3$	V
I_{IN}	Input Injection Current ⁽¹⁾		+1	mA
PD	Power Dissipation ^(2,3)		0.625	W
θ_{JA}	Thermal Resistance, Junction to Ambient ⁽²⁾		200	°C/W
T_J	Junction Temperature		150	°C
T_{STG}	Storage Temperature	-55	150	°C
ESD	Human Body Model (HBM)		1000	V
	Charge Device Model (CDM)		500	

Notes:

- Guaranteed by design. Full function, no latchup. Tested at 10 V and 17 V.
- The Thermal Resistance and power dissipation rating are measured per below conditions:
JESD51-2: Integral circuits thermal test method environmental conditions, natural convection/Still Air
JESD51-3: Low effective thermal conductivity test board for leaded surface-mount packages.
- Do not exceed power dissipation (P_D) under any circumstances.

Recommended Operating Conditions

The Recommended Operating Conditions table defines the conditions for actual device operation. Recommended operating conditions are specified to ensure optimal performance. Fairchild does not recommend exceeding them or designing to Absolute Maximum Ratings.

Symbol	Parameter	Min.	Max.	Unit
$V_B^{(4)}$	High-Side Floating Supply Voltage (DC) Transient: -10 V at 0.1 μ S	V_S+6	V_S+20	V
V_S	High-Side Floating Supply Offset Voltage (DC) Transient: -25 V(max.) at 0.1 μ S at $V_{BS} < 25$ V	-5	600	V
V_{HO}	High-Side Output Voltage	V_S	V_B	V
V_{LO}	Low-Side Output Voltage	0	V_{CC}	V
V_{CC}	Supply Voltage for Logic Input	5.5	20	V
V_{IN}	Logic Input Voltage	0	V_{CC}	V
dv/dt	Allowable Offset Voltage Slew Rate ⁽⁵⁾		50	V/nS
T_{PULSE}	Minimum Pulse Width ^(5,6)	1100		nS
F_S	Switching Frequency ⁽⁶⁾		200	KHz
T_A	Operating Ambient Temperature	-40	125	°C

Notes:

- The V_S offset is tested with all supplies based at 15 V differential
- Guaranteed by design.
- When $V_{DT} = 1.2$ V. Refer to Figures 5, 6, 7 and 8.

Electrical Characteristics

Unless otherwise specified $-40^{\circ}\text{C} \leq T_A \leq 125^{\circ}\text{C}$, $V_{CC} = 15\text{ V}$, $V_{BS} = 15\text{ V}$, $V_S = 0\text{ V}$, $C_L = 1\text{ nF}$

Symbol	Parameter	Conditions	Min.	Typ.	Max.	Unit
V_{CC} and V_{BS} Supply Characteristics						
V _{CCUV+} V _{BSUV+}	V _{CC} and V _{BS} Supply Under-Voltage Positive going Threshold			4.2	5.5	V
V _{CCUV-} V _{BSUV-}	V _{CC} and V _{BS} Supply Under-Voltage Negative going Threshold		2.8	3.6		V
V _{CCUVH} V _{BSUVH}	V _{CC} and V _{BS} Supply Under-Voltage Hysteresis		0.2	0.6		V
t _{DUVCC} t _{DUVBS}	Under-Voltage Lockout Response Time	V _{CC} : 6 V → 2.5 V or 2.5 V → 6 V	0.5		20	μs
		V _{BS} : 6 V → 2.5 V or 2.5 V → 6 V	0.5		20	
I _{LK}	Offset Supply Leakage Current	V _B = V _S = 600 V		20	50	μA
I _{QBS}	Quiescent V _{BS} Supply Current	V _{IN} = 0 or 5 V, V _S DT = 1.2 V	20	75	150	μA
I _{QCC}	Quiescent V _{CC} Supply Current	V _{IN} = 0 or 5 V, V _S DT = 1.2 V		350	1000	μA
Input Characteristics						
V _{IH}	High Logic level Input Voltage		2.7			V
V _{IL}	Low Logic Level Input Voltage				0.8	V
I _{IN+}	Logic Input High Bias Current	V _{IN} = 5 V		10	50	μA
I _{IN-}	Logic Input Low Bias Current	V _{IN} = 0 V		0	2	μA
V _{DT}	V _{DT} Dead Time Setting Range		1.2		5.0	V
V _{SD}	V _{SD} Shutdown Threshold Voltage			0.8	1.2	V
R _S DT	High Logic Level Resistance for /SD /DT	V _S DT = 5 V	100	500	1100	kΩ
I _S DT-	Low Logic Level Input bias Current for /SD /DT	V _S DT = 0 V		1	2	μA
Output Characteristics						
V _{OH} (HO)	High Level Output Voltage (V _{CC} - V _{HO})	I _O = 0			0.1	V
V _{OL} (HO)	Low Level Output Voltage (V _{HO})	I _O = 0			0.1	V
I _{O+} (HO)	Output High, Short-Circuit Pulse Current		250	300		mA
I _{O-} (HO)	Output Low, Short-Circuit Pulse Current		500	600		mA
R _{OP} (HO)	Equivalent Output Resistance				60	Ω
R _{ON} (HO)					30	
V _{OH} (LO)	High Level Output Voltage (V _B - V _{LO})	I _O = 0			0.1	V
V _{OL} (LO)	Low Level Output Voltage (V _{LO})	I _O = 0			0.1	V
I _{O+} (LO)	Output High, Short-Circuit Pulse Current		250			mA
I _{O-} (LO)	Output Low, Short-Circuit Pulse Current		500			mA
R _{OP} (LO)	Equivalent Output Resistance				60	Ω
R _{ON} (LO)					30	

Dynamic Electrical Characteristics

Unless otherwise specified $-40^{\circ}\text{C} \leq T_A \leq 125^{\circ}\text{C}$, $V_{CC} = 15\text{ V}$, $V_{BS}=15\text{ V}$, $V_S = 0\text{ V}$, $C_L = 1\text{ nF}$

Symbol	Parameter	Conditions	Min.	Typ.	Max.	Unit
t_{ON}	Turn-On Propagation Delay ⁽⁷⁾	$V_S=0\text{ V}$		750	1500	ns
t_{OFF}	Turn-Off Propagation Delay	$V_S=0\text{ V}$		130	250	ns
t_R	Turn-On Rise Time			40	150	ns
t_F	Turn-Off Fall Time			25	400	ns
D_T	Dead Time, LS Turn-off to HS Turn-on and HS Turn-on to LS Turn-off	$V_{IN} = 0$ or 5 V at $V_{DT} = 1.2\text{ V}$	250	650	1200	ns
		$V_{IN} = 0$ or 5 V at $V_{DT} = 1.2\text{ V}$	1600	2100	2600	
M_{DT}	Dead Time Matching Time	$DT1 - DT2$ at $V_{DT} = 1.2\text{ V}$		35	110	ns
		$DT1 - DT2$ at $V_{DT} = 3.3\text{ V}$			300	
M_{TON}	Delay Matching, HS and LS Turn-on	$V_{DT} = 1.2\text{ V}$		25	110	ns
M_{TOFF}	Delay Matching, HS and LS Turn-off	$V_{DT} = 1.2\text{ V}$		15	60	ns
t_{SD}	Shutdown Propagation Delay			180	330	ns
F_{S1}	Switching Frequency	$V_{CC} = V_{BS} = 20\text{ V}$			200	Khz
F_{S2}		$V_{CC} = V_{BS} = 5.5\text{ V}$			200	

Notes:

7. t_{ON} includes DT

Typical Waveforms

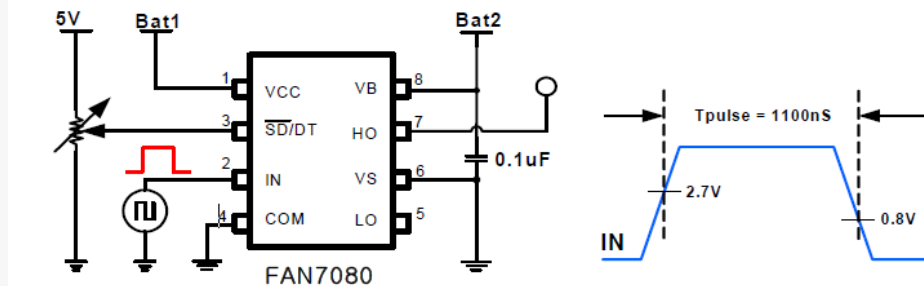

Figure 5. Short Pulse Width Test Circuit and Pulse Width Waveform

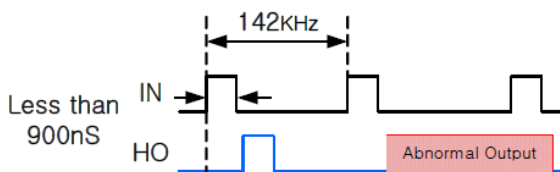

Figure 6. Abnormal Output Waveform with Pulse Width

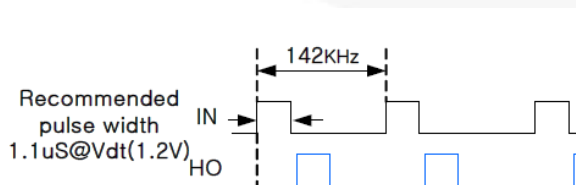

Figure 7. Recommendation of Pulse width Output Waveform

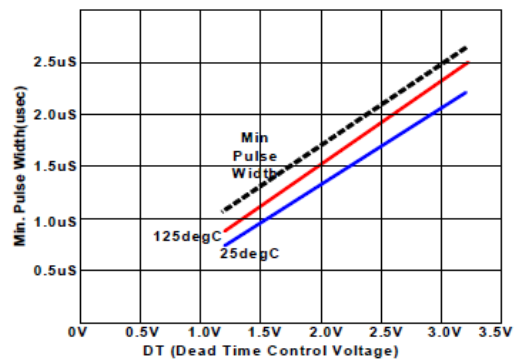

Figure 8. Pulse Width vs. VDT

Typical Performance Characteristics

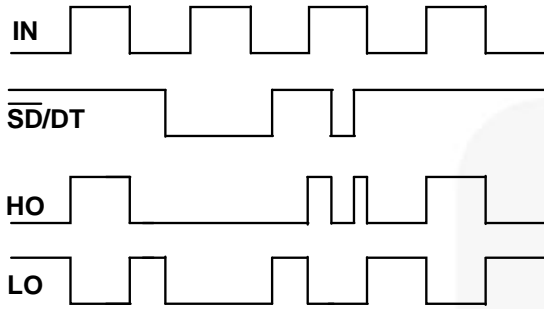

Figure 9. Input/Output Timing Diagram

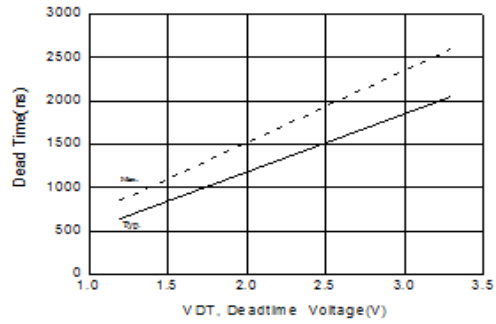
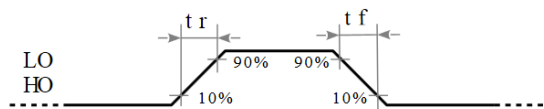

Figure 10. Dead Time vs. V_{DT} (V_{CC}=V_{BS}=15 V, -40°C < T_J < 125°C)



Note: not drawn to scale

Figure 11. Switching Time Waveform Definitions

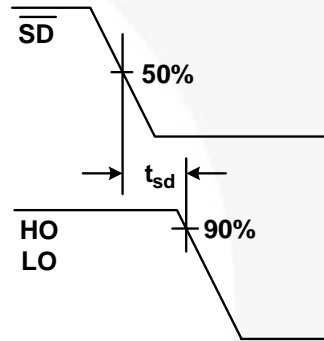

Figure 12. Shutdown Waveform Definitions

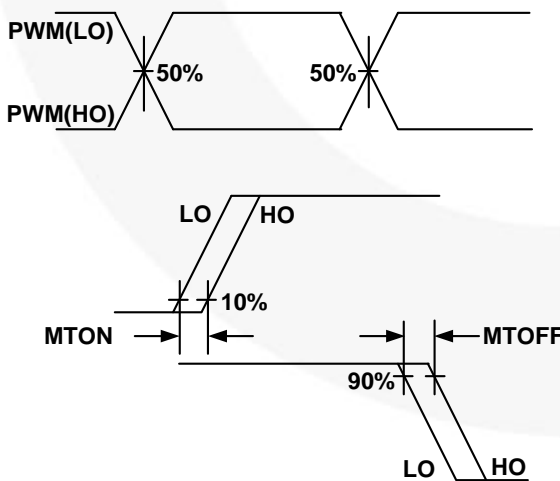
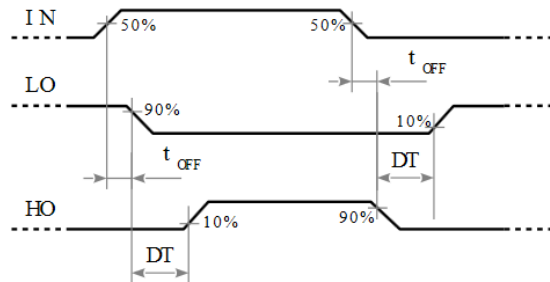

Figure 13. Delay Matching Waveform Definitions



Note: not drawn to scale

Figure 14. Dead Time Waveform Definitions

Typical Performance Characteristics

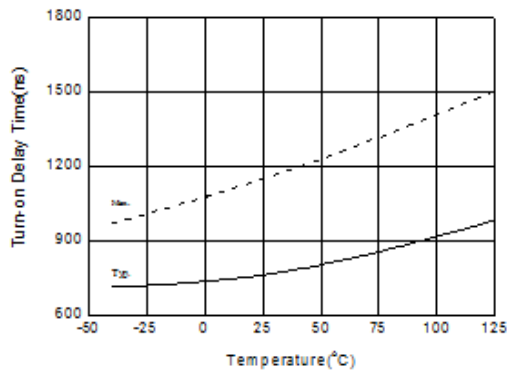

Figure 15. Turn-on Delay Time of HO vs. Temperature ($V_{CC}=V_{BS}=15\text{ V}$, $C_L=1\text{ nF}$)

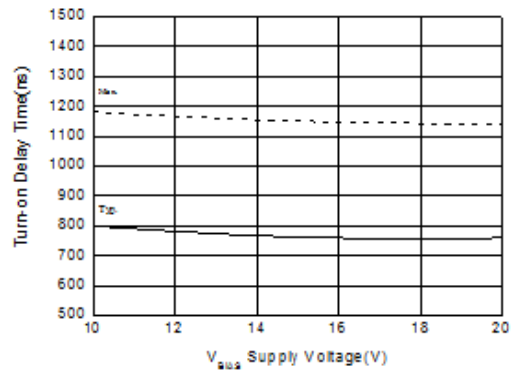

Figure 16. Turn-on Delay Time of HO vs. V_{BS} Supply Voltage ($V_{CC}=15\text{ V}$, $C_L=1\text{ nF}$, $T_A=25^\circ\text{C}$)

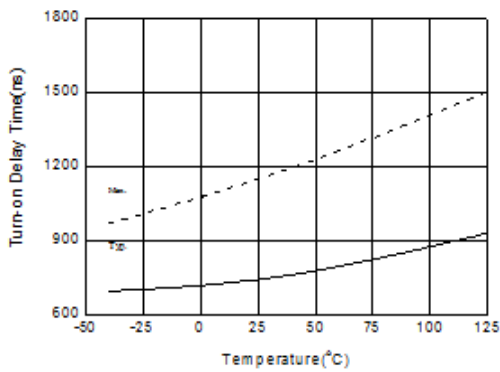

Figure 17. Turn-on Delay Time of LO vs. Temperature ($V_{CC}=V_{BS}=15\text{ V}$, $C_L=1\text{ nF}$)

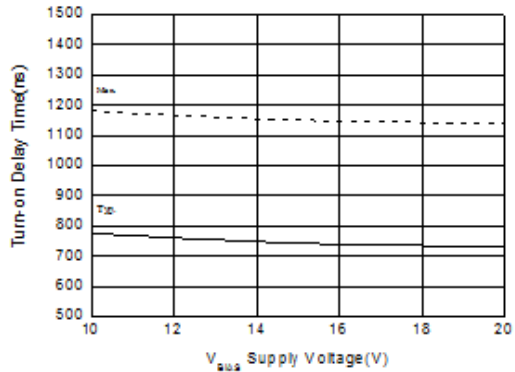

Figure 18. Turn-on Delay Time of LO vs. V_{BS} Supply Voltage ($V_{CC}=15\text{ V}$, $C_L=1\text{ nF}$, $T_A=25^\circ\text{C}$)

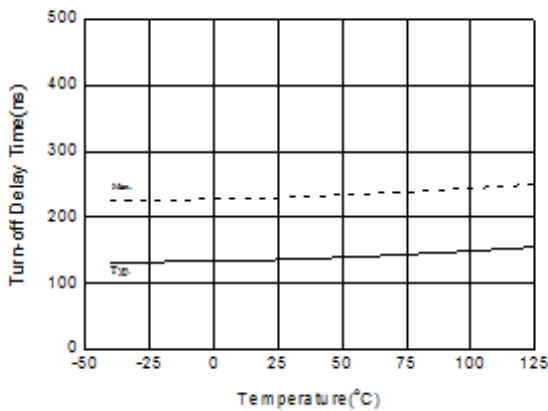

Figure 19. Turn-off Delay Time of HO vs. Temperature ($V_{CC}=V_{BS}=15\text{ V}$, $C_L=1\text{ nF}$)

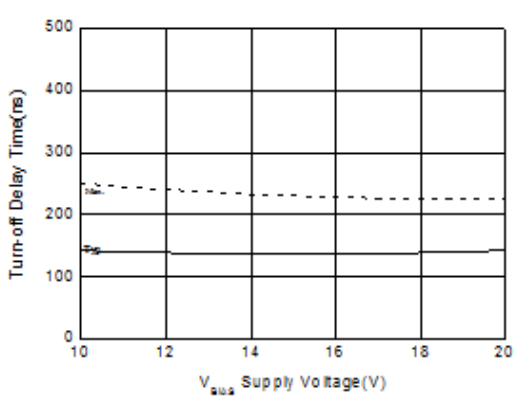

Figure 20. Turn-off Delay Time of HO vs. V_{BS} Supply Voltage ($V_{CC}=15\text{ V}$, $C_L=1\text{ nF}$, $T_A=25^\circ\text{C}$)

Typical Performance Characteristics

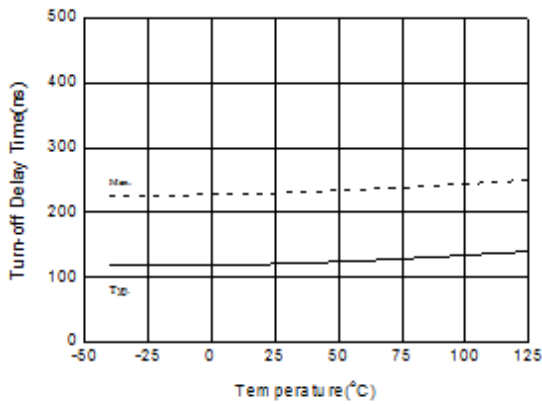

Figure 21. Turn-off Delay Time of LO vs. Temperature ($V_{CC}=V_{BS}=15\text{ V}$, $C_L=1\text{ nF}$)

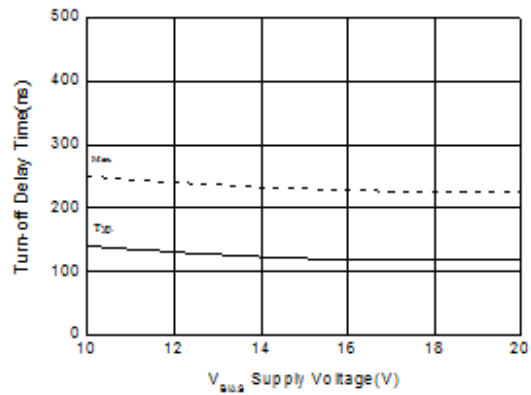

Figure 22. Turn-off Delay Time of LO vs. V_{BS} Supply Voltage ($V_{CC}=15\text{ V}$, $C_L=1\text{ nF}$, $T_A=25^\circ\text{C}$)

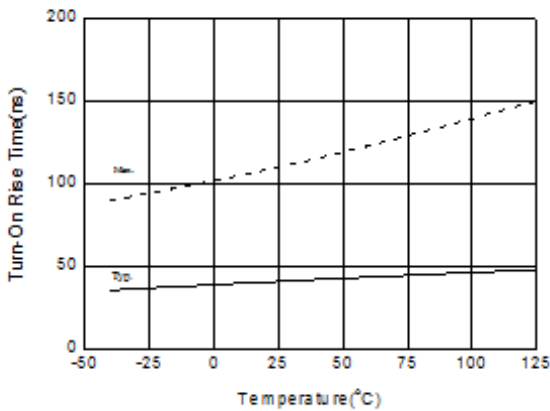

Figure 23. Turn-on Rise Time of HO vs. Temperature ($V_{CC}=V_{BS}=15\text{ V}$, $C_L=1\text{ nF}$)

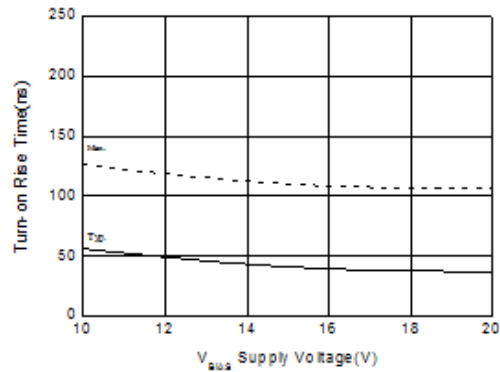

Figure 24. Turn-on Rise Time of HO vs. V_{BS} Supply Voltage ($V_{CC}=15\text{ V}$, $C_L=1\text{ nF}$, $T_A=25^\circ\text{C}$)

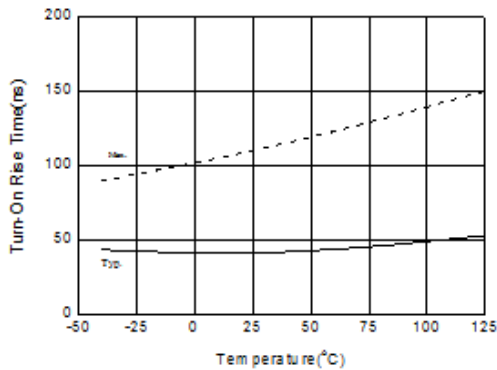

Figure 25. Turn-on Rise Time of LO vs. Temperature ($V_{CC}=V_{BS}=15\text{ V}$, $C_L=1\text{ nF}$)

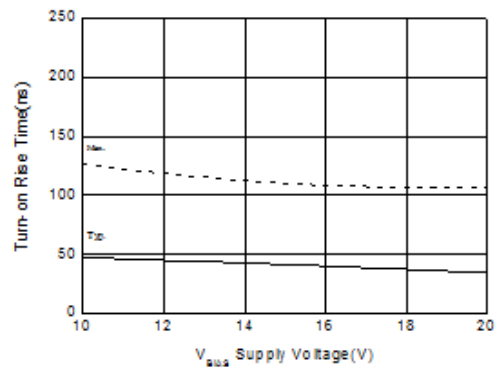

Figure 26. Turn-on Rise Time of LO vs. V_{BS} Supply Voltage ($V_{CC}=15\text{ V}$, $C_L=1\text{ nF}$, $T_A=25^\circ\text{C}$)

Typical Performance Characteristics

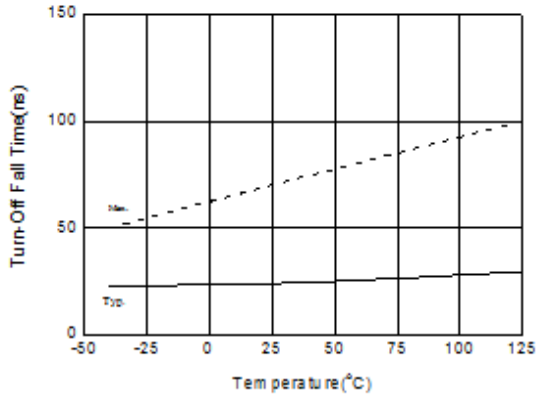

Figure 27. Turn-off Fall Time of HO vs. Temperature ($V_{CC}=V_{BS}=15\text{ V}$, $C_L=1\text{ nF}$)

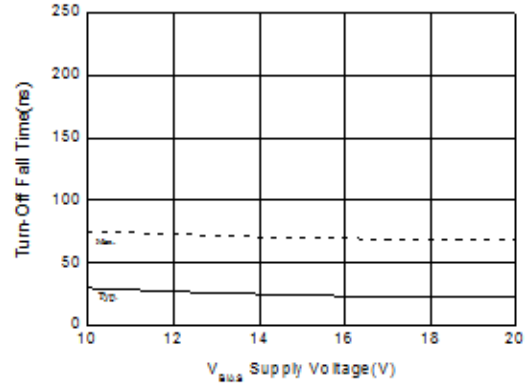

Figure 28. Turn-off Fall Time of HO vs. V_{BS} Supply Voltage ($V_{CC}=15\text{ V}$, $C_L=1\text{ nF}$, $T_A=25^\circ\text{C}$)

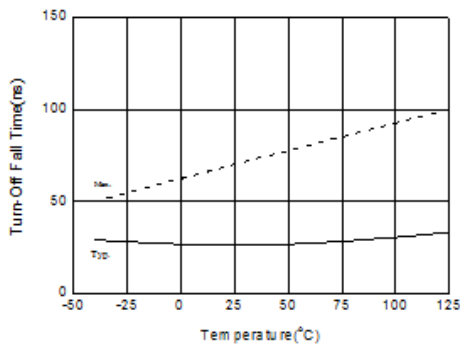

Figure 29. Turn-off Fall Time of LO vs. Temperature ($V_{CC}=V_{BS}=15\text{ V}$, $C_L=1\text{ nF}$)

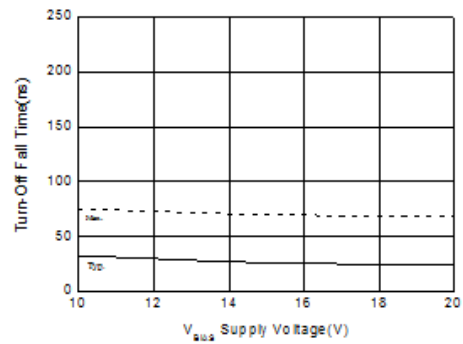

Figure 30. Turn-off Fall Time of LO vs. Temperature ($V_{CC}=V_{BS}=15\text{ V}$, $C_L=1\text{ nF}$)

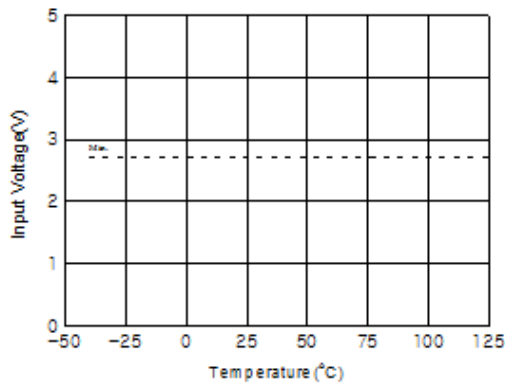

Figure 31. Logic Low Input Voltage vs. Temperature

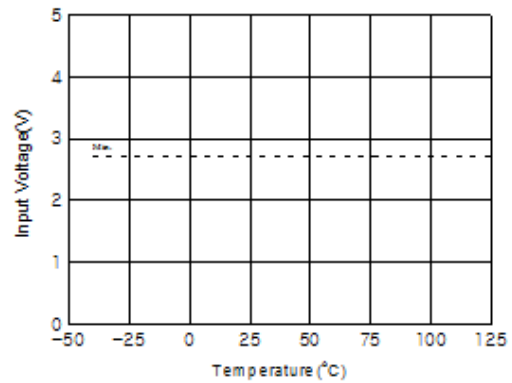

Figure 32. Logic High Input Voltage vs. Temperature

Typical Performance Characteristics

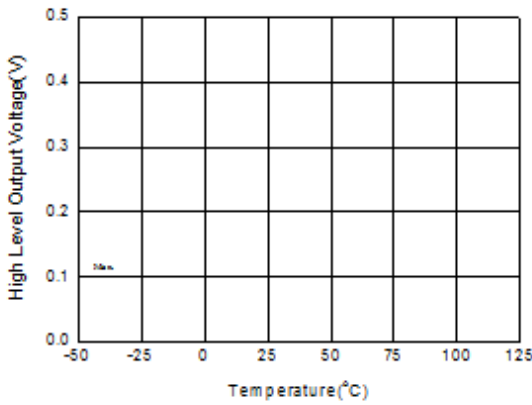

Figure 33. High Level Output of HO vs. Temperature ($V_{CC}=V_{BS}=15\text{ V}$)

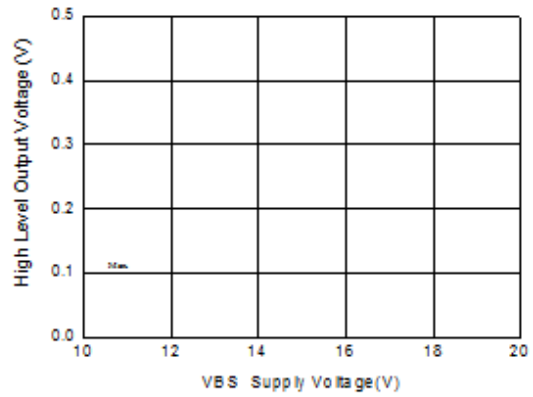

Figure 34. High Level Output of HO vs. V_{BS} Supply Voltage ($V_{CC}=15\text{ V}$, $T_A=25^\circ\text{C}$)

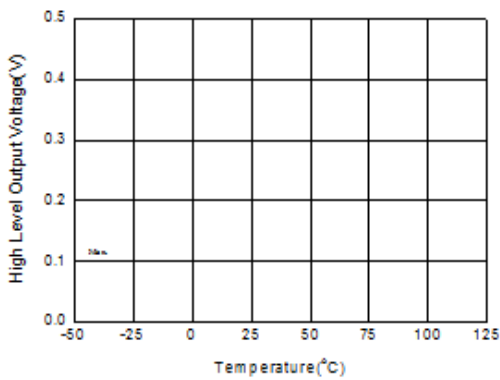

Figure 35. High Level Output of LO vs. Temperature ($V_{CC}=V_{BS}=15\text{ V}$)

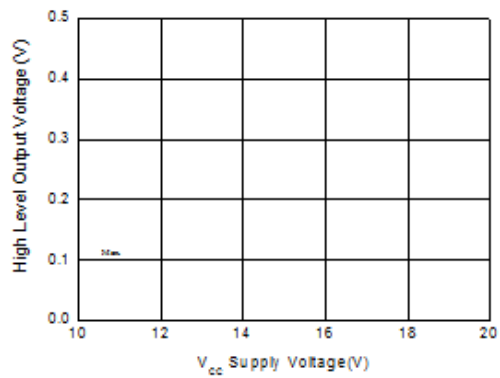

Figure 36. High Level Output of LO vs. V_{BS} Supply Voltage ($V_{CC}=15\text{ V}$, $T_A=25^\circ\text{C}$)

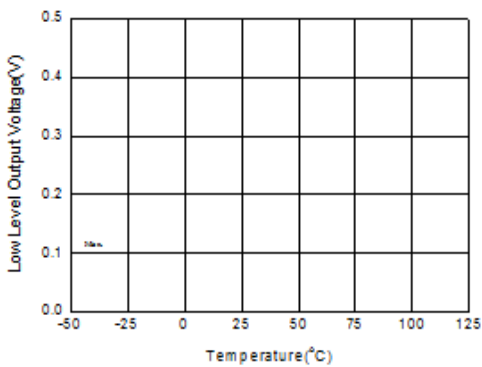

Figure 37. Low Level Output of HO vs. Temperature ($V_{CC}=V_{BS}=15\text{ V}$)

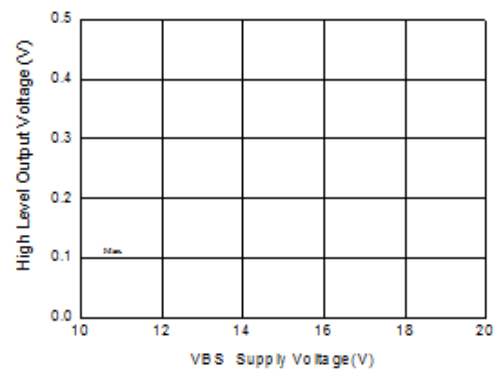

Figure 38. Low Level Output of HO vs. V_{BS} Supply Voltage ($V_{CC}=15\text{ V}$, $T_A=25^\circ\text{C}$)

Typical Performance Characteristics

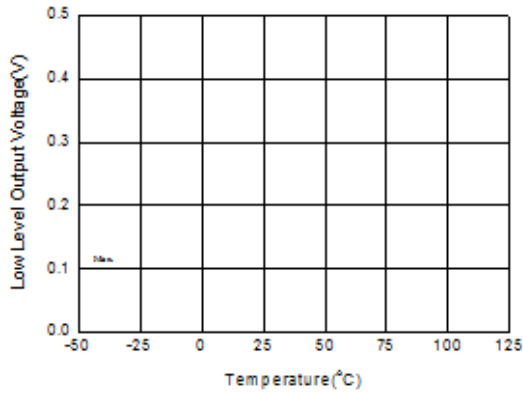

Figure 39. Low Level Output of LO vs. Temperature ($V_{CC}=V_{BS}=15\text{ V}$)

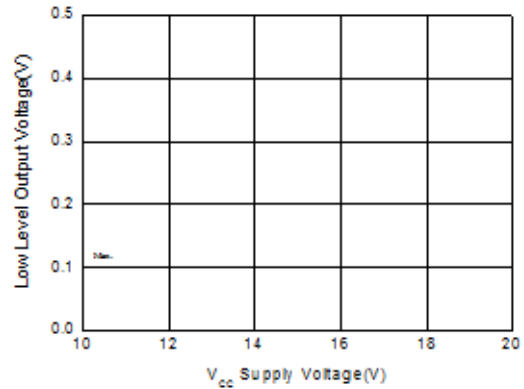

Figure 40. Low Level Output of LO vs. V_{CC} Supply Voltage ($V_{CC}=15\text{ V}$, $T_A=25^\circ\text{C}$)

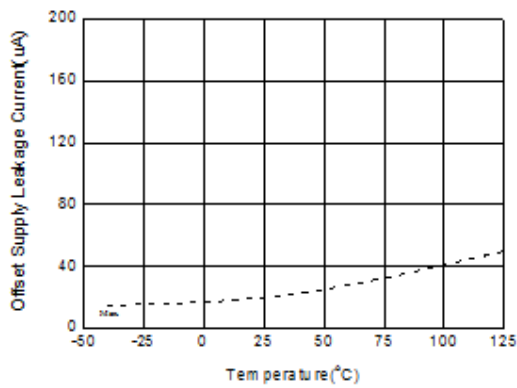

Figure 41. Offset Supply Leakage Current vs. Temperature ($V_{CC}=V_{BS}=600\text{ V}$)

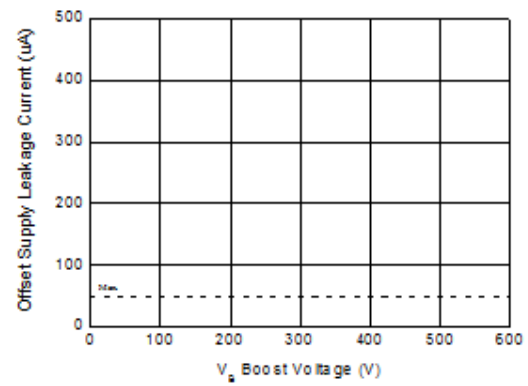

Figure 42. Offset Supply Leakage Current vs. V_B Boost Voltage ($V_{CC}=15\text{ V}$, $T_A=25^\circ\text{C}$)

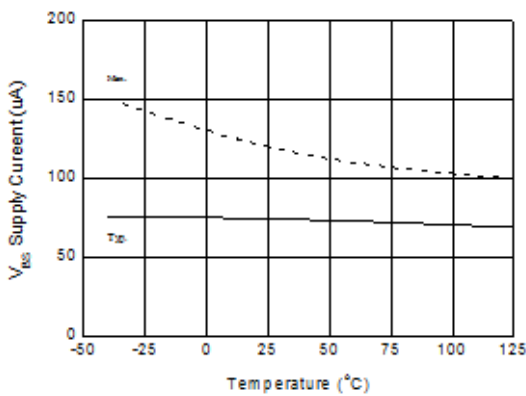

Figure 43. V_{BS} Supply Current vs. Temperature ($V_{BS}=15\text{ V}$)

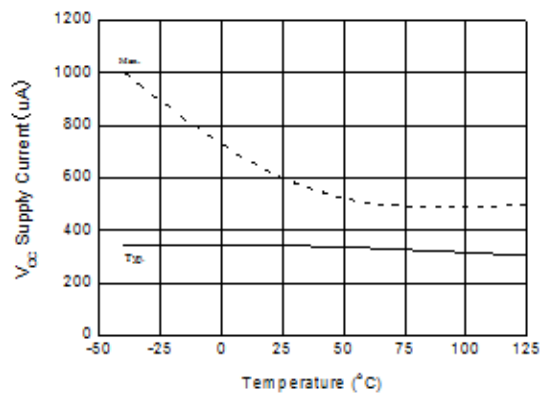

Figure 44. V_{CC} Supply Current vs. Temperature ($V_{CC}=15\text{ V}$)

Typical Performance Characteristics

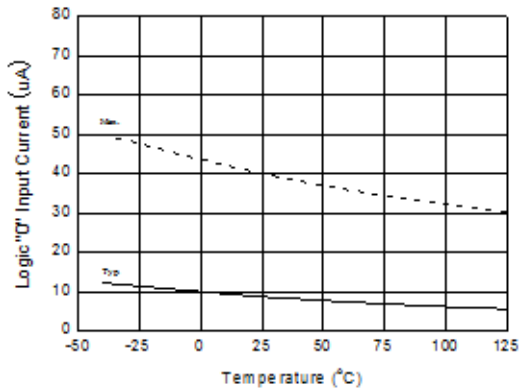

Figure 45. Logic High Input Current vs. Temperature ($V_{IN}=5\text{ V}$)

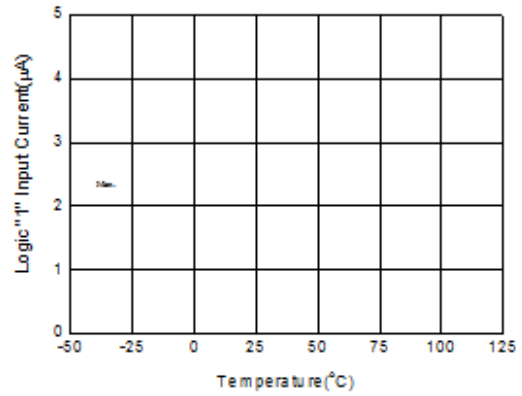

Figure 46. Logic Low Input Current vs. Temperature ($V_{IN}=5\text{ V}$)

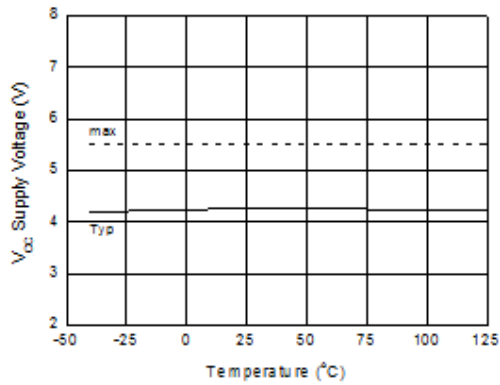

Figure 47. V_{CC} Under-Voltage Threshold (+) vs. Temperature

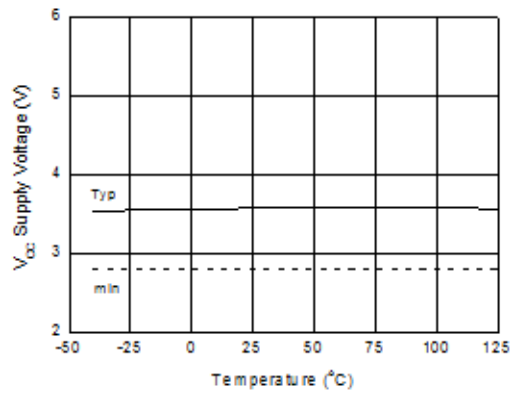

Figure 48. V_{CC} Under-Voltage Threshold (-) vs. Temperature

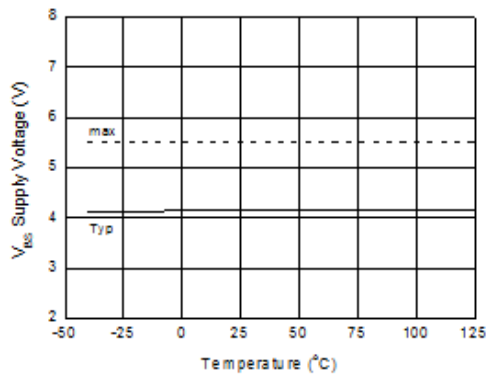

Figure 49. V_{BS} Under-Voltage Threshold (+) vs. Temperature

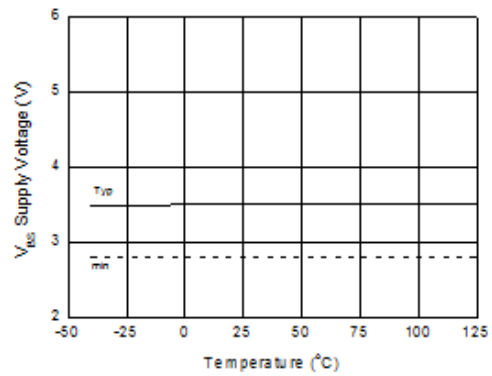

Figure 50. V_{BS} Under-Voltage Threshold (-) vs. Temperature

Typical Performance Characteristics

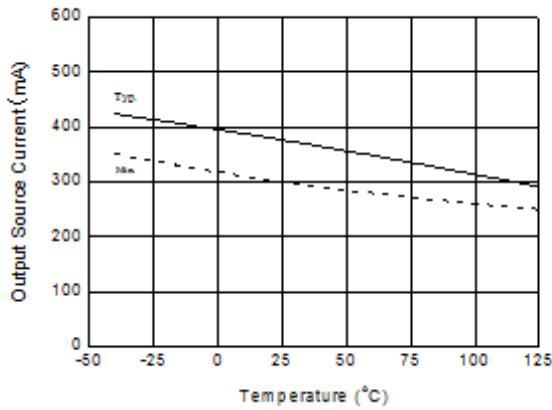

Figure 51. Output Source Current of HO vs. Temperature ($V_{CC}=V_{BS}=15\text{ V}$)

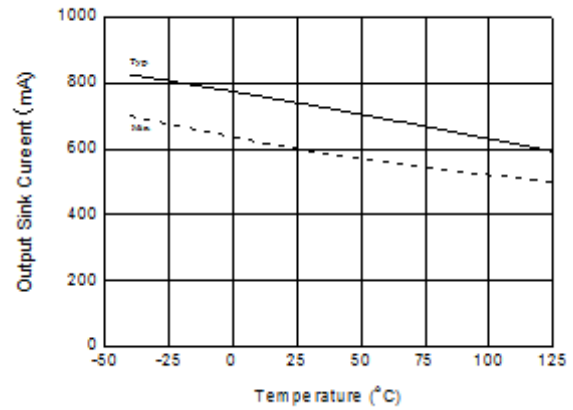

Figure 52. Output Sink Current of HO vs. Temperature ($V_{CC}=V_{BS}=15\text{ V}$)

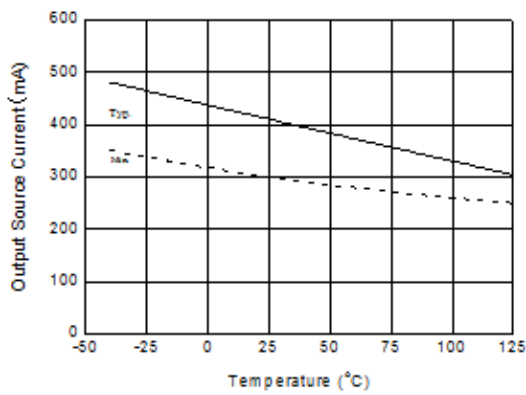

Figure 53. Output Source Current of LO vs. Temperature ($V_{CC}=V_{BS}=15\text{ V}$)

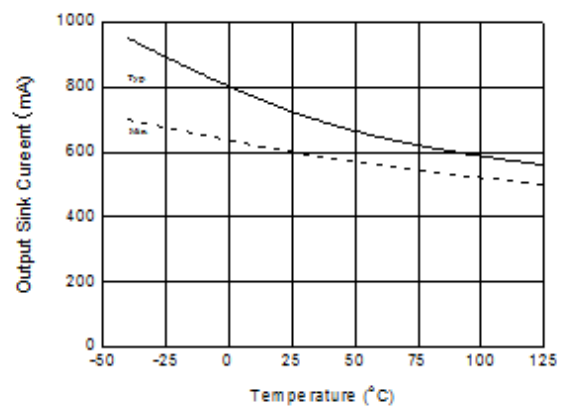

Figure 54. Output Sink Current of LO vs. Temperature ($V_{CC}=V_{BS}=15\text{ V}$)

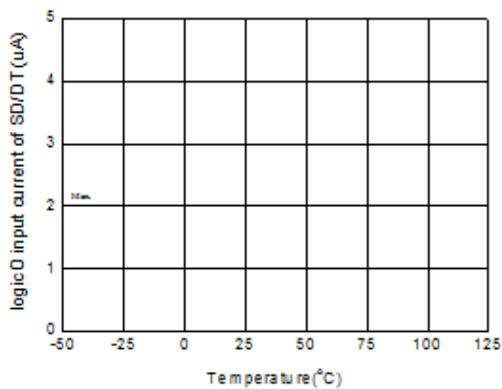

Figure 55. Logic Low Input Current of SD/DT vs. Temperature

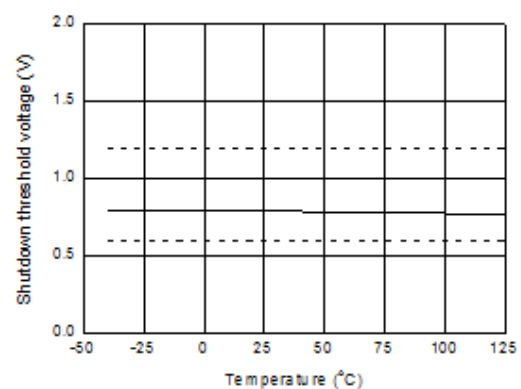

Figure 56. Shutdown Threshold Voltage vs. Temperature

Typical Performance Characteristics

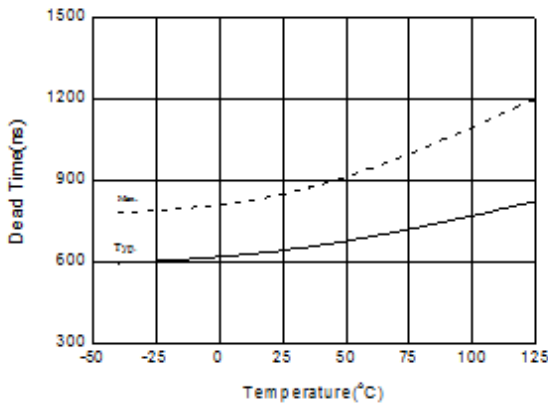

Figure 57. Deadtime vs. Temperature ($V_{CC}=V_{BS}=15\text{ V}$, $V_{DT}=1.2\text{ V}$)

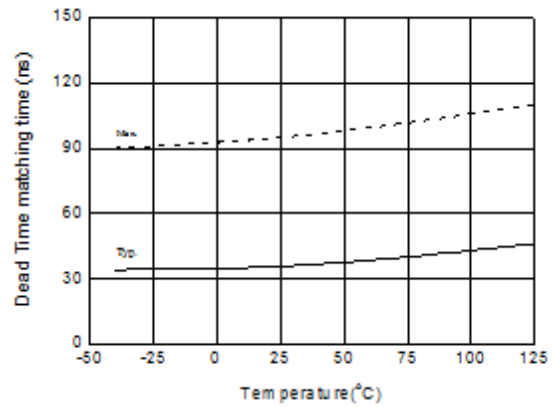

Figure 58. Deadtime Matching Time vs. Temperature ($V_{CC}=V_{BS}=15\text{ V}$, $V_{DT}=1.2\text{ V}$)

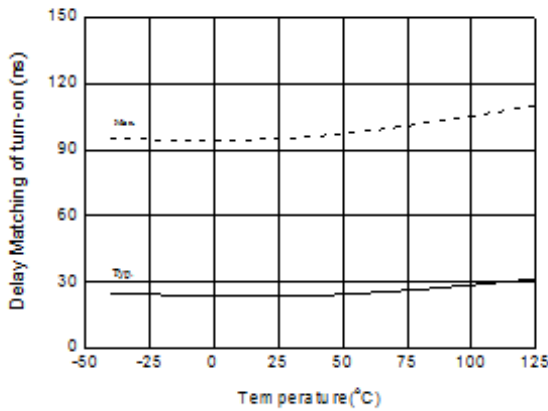

Figure 59. Turn-on Delay Matching vs. Temperature ($V_{CC}=V_{BS}=15\text{ V}$, $V_{DT}=1.2\text{ V}$)

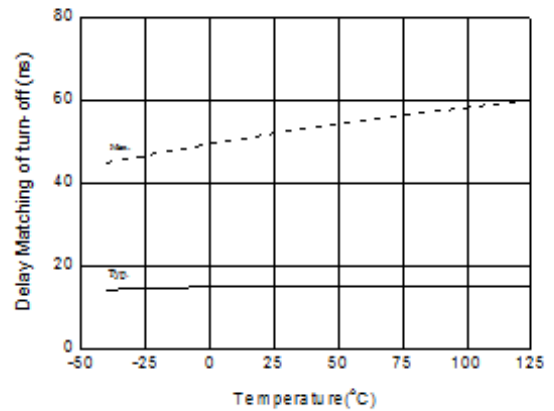

Figure 60. Turn-off Delay Matching vs. Temperature ($V_{CC}=V_{BS}=15\text{ V}$, $V_{DT}=1.2\text{ V}$)

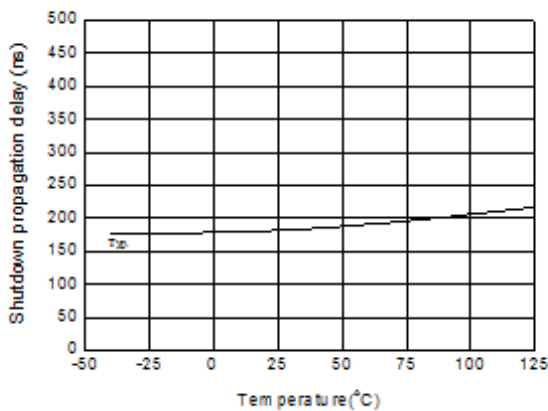

Figure 61. Shutdown Propagation Delay vs. Temperature

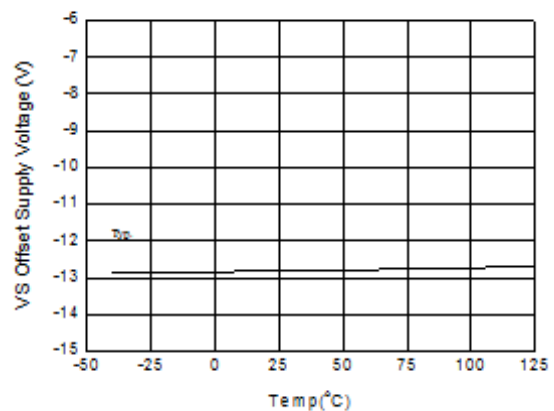
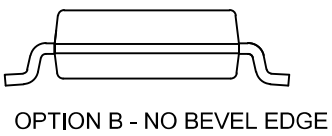
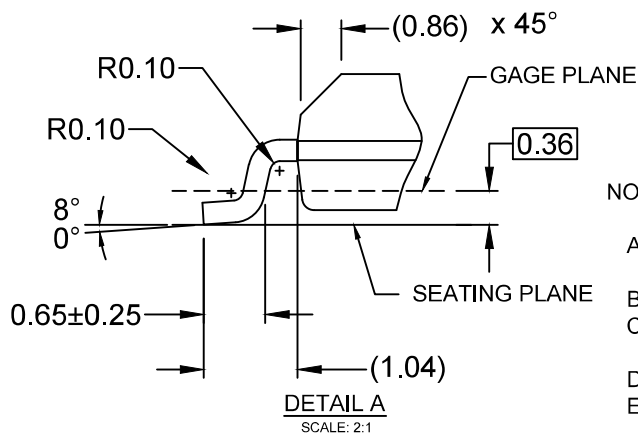
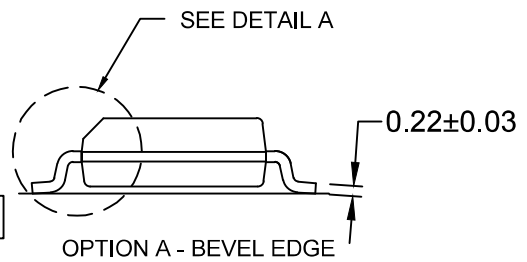
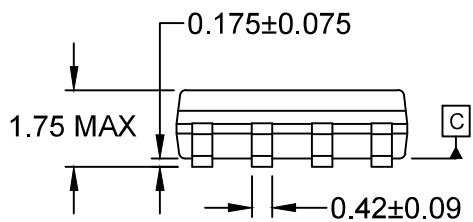
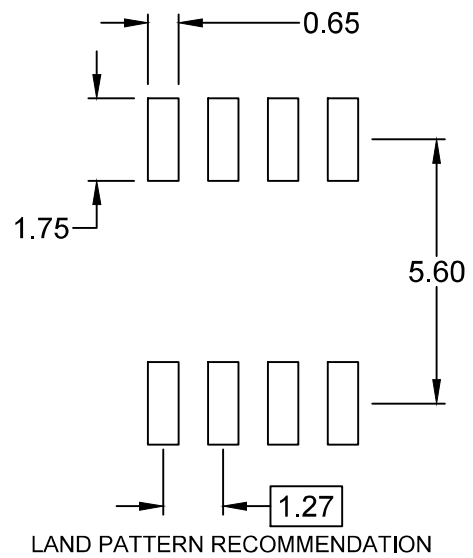
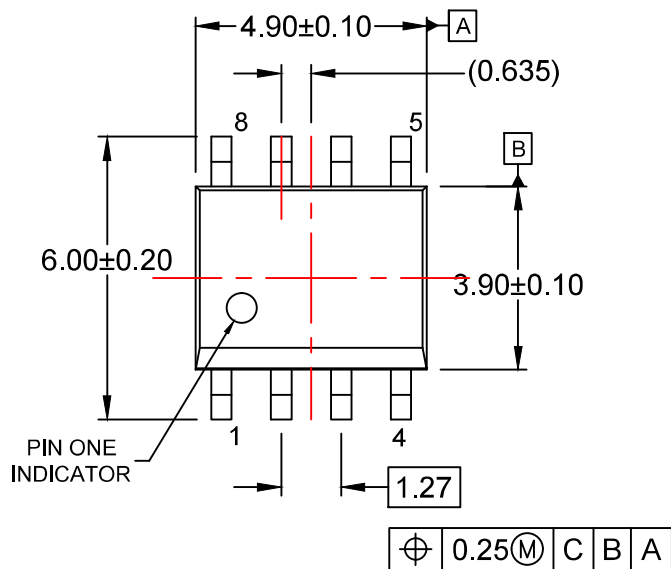

Figure 62. Maximum vs. Negative Offset Voltage vs. Temperature ($V_{CC}=V_{BS}=15\text{ V}$)



NOTES:

- A) THIS PACKAGE CONFORMS TO JEDEC MS-012, VARIATION AA.
- B) ALL DIMENSIONS ARE IN MILLIMETERS.
- C) DIMENSIONS DO NOT INCLUDE MOLD FLASH OR BURRS.
- D) LANDPATTERN STANDARD: SOIC127P600X175-8M
- E) DRAWING FILENAME: M08Arev16



ON Semiconductor and  are trademarks of Semiconductor Components Industries, LLC dba ON Semiconductor or its subsidiaries in the United States and/or other countries. ON Semiconductor owns the rights to a number of patents, trademarks, copyrights, trade secrets, and other intellectual property. A listing of ON Semiconductor's product/patent coverage may be accessed at www.onsemi.com/site/pdf/Patent-Marking.pdf. ON Semiconductor reserves the right to make changes without further notice to any products herein. ON Semiconductor makes no warranty, representation or guarantee regarding the suitability of its products for any particular purpose, nor does ON Semiconductor assume any liability arising out of the application or use of any product or circuit, and specifically disclaims any and all liability, including without limitation special, consequential or incidental damages. Buyer is responsible for its products and applications using ON Semiconductor products, including compliance with all laws, regulations and safety requirements or standards, regardless of any support or applications information provided by ON Semiconductor. "Typical" parameters which may be provided in ON Semiconductor data sheets and/or specifications can and do vary in different applications and actual performance may vary over time. All operating parameters, including "Typicals" must be validated for each customer application by customer's technical experts. ON Semiconductor does not convey any license under its patent rights nor the rights of others. ON Semiconductor products are not designed, intended, or authorized for use as a critical component in life support systems or any FDA Class 3 medical devices or medical devices with a same or similar classification in a foreign jurisdiction or any devices intended for implantation in the human body. Should Buyer purchase or use ON Semiconductor products for any such unintended or unauthorized application, Buyer shall indemnify and hold ON Semiconductor and its officers, employees, subsidiaries, affiliates, and distributors harmless against all claims, costs, damages, and expenses, and reasonable attorney fees arising out of, directly or indirectly, any claim of personal injury or death associated with such unintended or unauthorized use, even if such claim alleges that ON Semiconductor was negligent regarding the design or manufacture of the part. ON Semiconductor is an Equal Opportunity/Affirmative Action Employer. This literature is subject to all applicable copyright laws and is not for resale in any manner.

PUBLICATION ORDERING INFORMATION

LITERATURE FULFILLMENT:

Literature Distribution Center for ON Semiconductor
19521 E. 32nd Pkwy, Aurora, Colorado 80011 USA
Phone: 303-675-2175 or 800-344-3860 Toll Free USA/Canada
Fax: 303-675-2176 or 800-344-3867 Toll Free USA/Canada
Email: orderlit@onsemi.com

N. American Technical Support: 800-282-9855 Toll Free
USA/Canada
Europe, Middle East and Africa Technical Support:
Phone: 421 33 790 2910
Japan Customer Focus Center
Phone: 81-3-5817-1050

ON Semiconductor Website: www.onsemi.com
Order Literature: <http://www.onsemi.com/orderlit>
For additional information, please contact your local
Sales Representative

Mouser Electronics

Authorized Distributor

Click to View Pricing, Inventory, Delivery & Lifecycle Information:

[ON Semiconductor:](#)

[FAN7080MX_GF085](#)



Стандарт Электрон Связь

Мы молодая и активно развивающаяся компания в области поставок электронных компонентов. Мы поставляем электронные компоненты отечественного и импортного производства напрямую от производителей и с крупнейших складов мира.

Благодаря сотрудничеству с мировыми поставщиками мы осуществляем комплексные и плановые поставки широчайшего спектра электронных компонентов.

Собственная эффективная логистика и склад в обеспечивает надежную поставку продукции в точно указанные сроки по всей России.

Мы осуществляем техническую поддержку нашим клиентам и предпродажную проверку качества продукции. На все поставляемые продукты мы предоставляем гарантию .

Осуществляем поставки продукции под контролем ВП МО РФ на предприятия военно-промышленного комплекса России , а также работаем в рамках 275 ФЗ с открытием отдельных счетов в уполномоченном банке. Система менеджмента качества компании соответствует требованиям ГОСТ ISO 9001.

Минимальные сроки поставки, гибкие цены, неограниченный ассортимент и индивидуальный подход к клиентам являются основой для выстраивания долгосрочного и эффективного сотрудничества с предприятиями радиоэлектронной промышленности, предприятиями ВПК и научно-исследовательскими институтами России.

С нами вы становитесь еще успешнее!

Наши контакты:

Телефон: +7 812 627 14 35

Электронная почта: sales@st-electron.ru

Адрес: 198099, Санкт-Петербург,
Промышленная ул, дом № 19, литера Н,
помещение 100-Н Офис 331