



Micro Commercial Components



Micro Commercial Components
20736 Marilla Street Chatsworth
CA 91311
Phone: (818) 701-4933
Fax: (818) 701-4939

LMB2S THRU LMB10S

Features

- Low Profile: Typical height of 1.4mm
- High Temperature Soldering Guaranteed: 260°C/10 Second
- High surge current capability
- Halogen free available upon request by adding suffix "-HF"
- Epoxy meets UL 94 V-0 flammability rating
- Moisture Sensitivity Level 1
- Lead Free Finish/RoHS Compliant (Note1) ("P" Suffix designates Compliant. See ordering information)

Mechanical Data

- Terminals: Matte tin plated leads, solderable per J-STD-002B and JESD22-B102D

MCC Part Number	Device Marking	Maximum Recurrent Peak Reverse Voltage	Maximum RMS Voltage	Maximum DC Blocking Voltage
LMB2S	LB2S	200V	140V	200V
LMB4S	LB4S	400V	280V	400V
LMB6S	LB6S	600V	420V	600V
LMB8S	LB8S	800V	560V	800V
LMB10S	LB10S	1000V	700V	1000V

Electrical Characteristics @ 25°C Unless Otherwise Specified

Average Forward Current	$I_{F(AV)}$	1.0 A 0.8 A	on aluminum substrate on glass-epoxy P.C.B
Peak Forward Surge Current	I_{FSM}	30A	8.3ms, half sine
Maximum Instantaneous Forward Voltage	V_F	0.95V	$I_{FM} = 0.4A$; $T_A = 25^\circ C$
Maximum DC Reverse Current At Rated DC Blocking Voltage	I_R	5uA 500uA	$T_A = 25^\circ C$ $T_A = 125^\circ C$
Typical Thermal Resistance	R_{thJA}	80°C/W	Note 2
	R_{thJL}	25°C/W	
Rating For Fusing	I^2t	3.0A ² s	t < 8.30ms
Operating Junction and Storage Temperature Range	T_J T_{STG}	-55to+150 °C	

- Notes: 1. High Temperature Solder Exemption Applied, see EU Directive Annex Notes 7
2. Device mounted P.C.B with 0.47x0.47" (12mmx12mm) Copper Pads.

1.0 Amp Single Phase Glass Passivated Bridge Rectifier 200 to 1000 Volts

LMBS -1

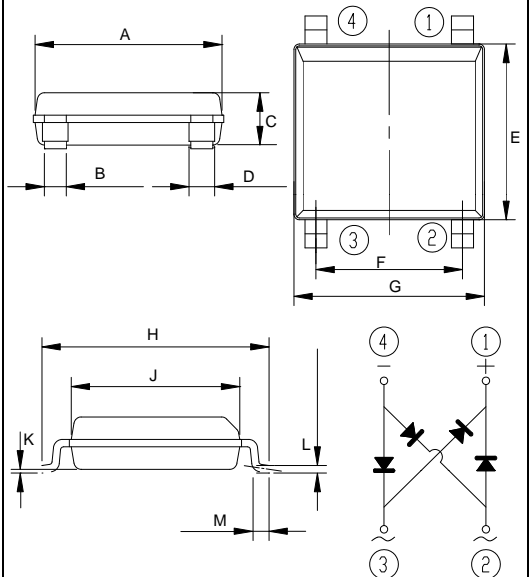

DIMENSIONS

DIM	INCHES		MM		NOTE
	MIN	MAX	MIN	MAX	
A	.197	.205	4.90	5.20	
B	.024		0.6		
C	----	.059	----	1.50	
D	.024	.032	0.60	0.80	
E	----	.189	----	4.80	
F	.150	.165	3.80	4.20	
G	----	.209	----	5.30	
H	.236	.252	6.00	6.60	
J	.177	.185	4.30	4.70	
K	.0009	.004	0.02	0.21	
L	.006	.012	0.15	0.30	
M	.017	.019	0.25	0.70	

Mounting Pad Layout

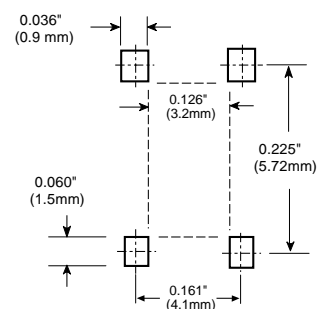

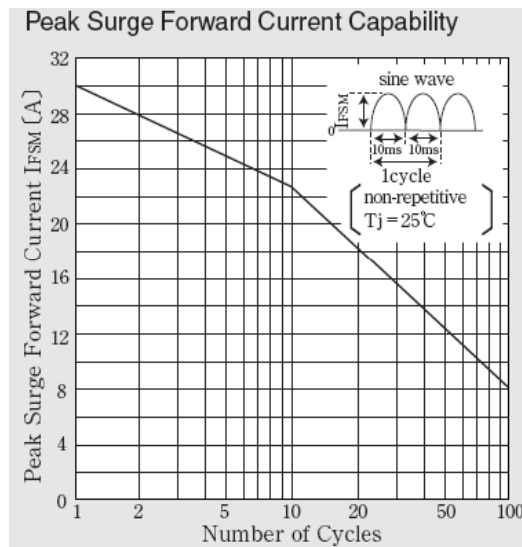
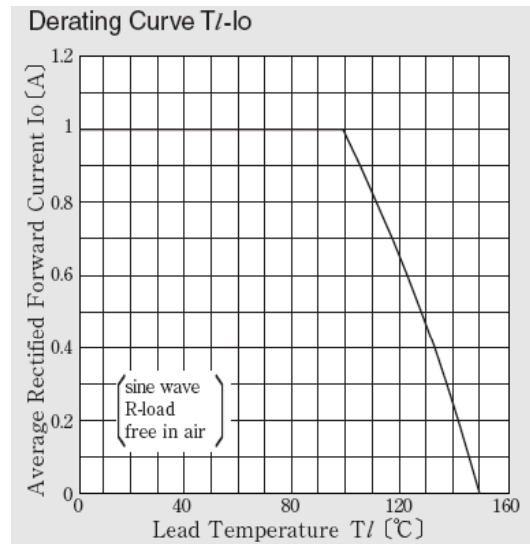
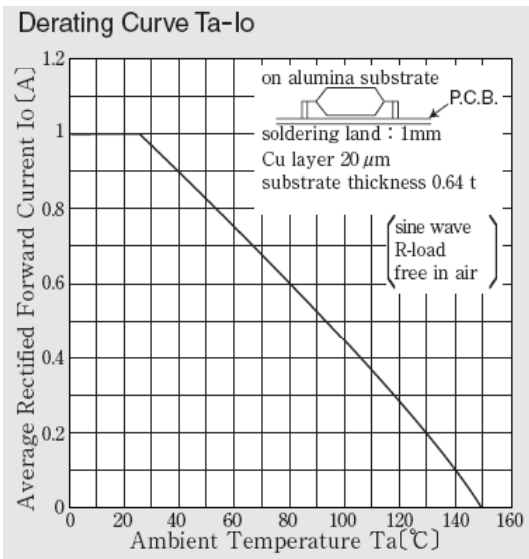
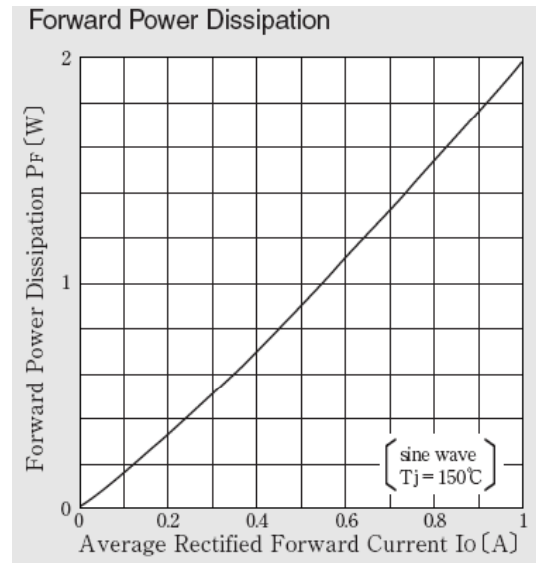
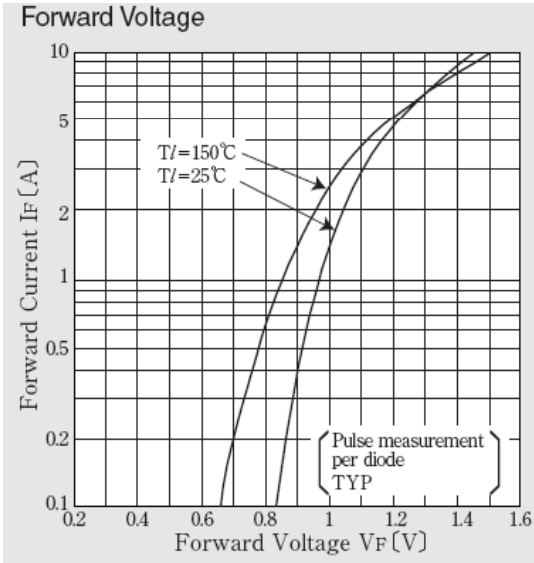



Micro Commercial Components

Ordering Information

Device	Packing
(Part Number)-TP	Tape&Reel;5Kpcs/Reel

Note : Adding "-HF" suffix for halogen free, eg. Part Number-TP-HF

IMPORTANT NOTICE

Micro Commercial Components Corp. reserves the right to make changes without further notice to any product herein to make corrections, modifications, enhancements, improvements, or other changes. **Micro Commercial Components Corp.** does not assume any liability arising out of the application or use of any product described herein; neither does it convey any license under its patent rights, nor the rights of others. The user of products in such applications shall assume all risks of such use and will agree to hold **Micro Commercial Components Corp.** and all the companies whose products are represented on our website, harmless against all damages.

LIFE SUPPORT

MCC's products are not authorized for use as critical components in life support devices or systems without the express written approval of Micro Commercial Components Corporation.

CUSTOMER AWARENESS

Counterfeiting of semiconductor parts is a growing problem in the industry. Micro Commercial Components (MCC) is taking strong measures to protect ourselves and our customers from the proliferation of counterfeit parts. MCC strongly encourages customers to purchase MCC parts either directly from MCC or from Authorized MCC Distributors who are listed by country on our web page cited below. Products customers buy either from MCC directly or from Authorized MCC Distributors are genuine parts, have full traceability, meet MCC's quality standards for handling and storage. **MCC will not provide any warranty coverage or other assistance for parts bought from Unauthorized Sources.** MCC is committed to combat this global problem and encourage our customers to do their part in stopping this practice by buying direct or from authorized distributors.

www.mccsemi.com



Стандарт Электрон Связь

Мы молодая и активно развивающаяся компания в области поставок электронных компонентов. Мы поставляем электронные компоненты отечественного и импортного производства напрямую от производителей и с крупнейших складов мира.

Благодаря сотрудничеству с мировыми поставщиками мы осуществляем комплексные и плановые поставки широчайшего спектра электронных компонентов.

Собственная эффективная логистика и склад в обеспечивает надежную поставку продукции в точно указанные сроки по всей России.

Мы осуществляем техническую поддержку нашим клиентам и предпродажную проверку качества продукции. На все поставляемые продукты мы предоставляем гарантию .

Осуществляем поставки продукции под контролем ВП МО РФ на предприятия военно-промышленного комплекса России , а также работаем в рамках 275 ФЗ с открытием отдельных счетов в уполномоченном банке. Система менеджмента качества компании соответствует требованиям ГОСТ ISO 9001.

Минимальные сроки поставки, гибкие цены, неограниченный ассортимент и индивидуальный подход к клиентам являются основой для выстраивания долгосрочного и эффективного сотрудничества с предприятиями радиоэлектронной промышленности, предприятиями ВПК и научно-исследовательскими институтами России.

С нами вы становитесь еще успешнее!

Наши контакты:

Телефон: +7 812 627 14 35

Электронная почта: sales@st-electron.ru

Адрес: 198099, Санкт-Петербург,
Промышленная ул, дом № 19, литера Н,
помещение 100-Н Офис 331