

## Low Current Mini SMD LED



19226

### DESCRIPTION

The new low current MiniLED Series have been designed in a small white SMT package. The feature of the device is the very small package 2.3 mm x 1.3 mm x 1.4 mm and the low forward current. The MiniLED is an obvious solution for small-scale, high-power products that are expected to work reliably in an arduous environment. This is often the case in automotive and industrial application.

### PRODUCT GROUP AND PACKAGE DATA

- Product group: LED
- Package: SMD MiniLED
- Product series: low current
- Angle of half intensity:  $\pm 60^\circ$

### FEATURES

- SMD LED with exceptional brightness
- Luminous intensity categorized
- Compatible with automatic placement equipment
- Available in 8 mm tape
- Low profile package
- Non-diffused lens: excellent for coupling to light pipes and backlighting
- Low power consumption
- IR reflow soldering according to J-STD-020
- Luminous intensity ratio in one packaging unit  $I_{Vmax}/I_{Vmin} \leq 1.6$
- Preconditioning according to JEDEC® level 2a
- ESD-withstand voltage: up to 2 kV according to JESD22-A114-B
- AEC-Q101 qualified
- Material categorization: for definitions of compliance please see [www.vishay.com/doc?99912](http://www.vishay.com/doc?99912)

 AUTOMOTIVE  
GRADE

**RoHS**  
COMPLIANT  
HALOGEN  
**FREE**  
**GREEN**  
(5-2008)

### APPLICATIONS

- Automotive: backlighting in dashboards and switches
- Telecommunication: indicator and backlighting in telephone and fax
- Indicator and backlight for audio and video equipment
- Indicator and backlight in office equipment
- Flat backlight for LCDs, switches, and symbols

### PARTS TABLE

PART	COLOR	LUMINOUS INTENSITY (mcd)			at I <sub>F</sub> (mA)	WAVELENGTH (nm)			at I <sub>F</sub> (mA)	FORWARD VOLTAGE (V)			at I <sub>F</sub> (mA)	TECHNOLOGY
		MIN.	TYP.	MAX.		MIN.	TYP.	MAX.		MIN.	TYP.	MAX.		
VLMS2000-GS08	Super red	2.24	4.5	-	2	-	630	-	2	-	1.8	2.2	2	AllnGaP on GaAs
VLMS20H2K1-GS08	Super red	3.55	-	9	2	-	630	-	2	-	1.8	2.2	2	AllnGaP on GaAs
VLMS20H2L1-GS08	Super red	3.55	-	14	2	-	630	-	2	-	1.8	2.2	2	AllnGaP on GaAs
VLMS20J2K2-GS08	Super red	5.6	-	11.2	2	-	630	-	2	-	1.8	2.2	2	AllnGaP on GaAs
VLMS20J2L1-GS08	Super red	5.6	-	14	2	-	630	-	2	-	1.8	2.2	2	AllnGaP on GaAs
VLMK20J2L1-GS08	Amber	5.6	-	14	2	612	622	624	2	-	1.8	2.2	2	AllnGaP on GaAs
VLMK20J2L2-GS08	Amber	5.6	-	18	2	612	622	624	2	-	1.8	2.2	2	AllnGaP on GaAs
VLMK2000-GS08	Amber	7.1	16	-	2	612	622	624	2	-	1.8	2.2	2	AllnGaP on GaAs
VLMK20K1L2-GS08	Amber	7.1	-	18	2	612	622	624	2	-	1.8	2.2	2	AllnGaP on GaAs
VLMO2000-GS08	Soft orange	4.5	9	-	2	598	605	611	2	-	1.8	2.2	2	AllnGaP on GaAs
VLMO20J2M1-GS08	Soft orange	5.6	-	22.4	2	598	605	611	2	-	1.8	2.2	2	AllnGaP on GaAs
VLMO20K1L2-34-GS08	Soft orange	7.1	-	18	2	602	-	607	2	-	1.8	2.2	2	AllnGaP on GaAs
VLMO20K2L2-35-GS08	Soft orange	9	-	18	2	602	-	609	2	-	1.8	2.2	2	AllnGaP on GaAs
VLMY2000-GS08	Yellow	3.55	7.1	-	2	581	588	594	2	-	1.8	2.2	2	AllnGaP on GaAs
VLMY20J1L2-GS08	Yellow	4.5	-	18	2	581	588	594	2	-	1.8	2.2	2	AllnGaP on GaAs
VLMY20K1L2-GS08	Yellow	7.1	-	18	2	581	588	594	2	-	1.8	2.2	2	AllnGaP on GaAs
VLMP20D2G1-GS08	Pure green	0.56	-	2.24	2	555	-	565	2	-	1.8	2.2	2	AllnGaP on GaAs



<b>ABSOLUTE MAXIMUM RATINGS</b> ( $T_{amb} = 25\text{ }^{\circ}\text{C}$ , unless otherwise specified) <b>VLMS20.., VLMS20.., VLMS20.., VLMS20.., VLMS20..</b>				
PARAMETER	TEST CONDITION	SYMBOL	VALUE	UNIT
Reverse voltage <sup>(1)</sup>		$V_R$	5	V
DC forward current	$T_{amb} \leq 100\text{ }^{\circ}\text{C}$	$I_F$	15	mA
Surge forward current	$t_p \leq 10\text{ }\mu\text{s}$	$I_{FSM}$	0.1	A
Power dissipation		$P_V$	40	mW
Junction temperature		$T_j$	+125	$^{\circ}\text{C}$
Operating temperature range		$T_{amb}$	-40 to +100	$^{\circ}\text{C}$
Storage temperature range		$T_{stg}$	-40 to +100	$^{\circ}\text{C}$
Thermal resistance junction/ambient	Mounted on PC board (pad size > 5 mm <sup>2</sup> )	$R_{thJA}$	580	K/W

**Note**

<sup>(1)</sup> Driving the LED in reverse direction is suitable for a short term application

<b>OPTICAL AND ELECTRICAL CHARACTERISTICS</b> ( $T_{amb} = 25\text{ }^{\circ}\text{C}$ , unless otherwise specified) <b>VLMS20.., SUPER RED</b>							
PARAMETER	TEST CONDITION	PART	SYMBOL	MIN.	TYP.	MAX.	UNIT
Luminous intensity <sup>(1)</sup>	$I_F = 2\text{ mA}$	VLMS2000	$I_V$	2.24	4.5	-	mcd
		VLMS20H2K1	$I_V$	3.55	-	9	mcd
		VLMS20H2L1	$I_V$	3.55	-	14	mcd
		VLMS20J2K2	$I_V$	5.6	-	11.2	mcd
		VLMS20J2L1	$I_V$	5.6	-	14	mcd
Dominant wavelength	$I_F = 2\text{ mA}$		$\lambda_d$	-	630	-	nm
Peak wavelength	$I_F = 2\text{ mA}$		$\lambda_p$	-	643	-	nm
Angle of half intensity	$I_F = 2\text{ mA}$		$\phi$	-	$\pm 60$	-	deg
Forward voltage	$I_F = 2\text{ mA}$		$V_F$	-	1.8	2.2	V
Reverse voltage	$I_R = 10\text{ }\mu\text{A}$		$V_R$	5	-	-	V
Junction capacitance	$V_R = 0\text{ V}$ , $f = 1\text{ MHz}$		$C_j$	-	15	-	pF

**Note**

<sup>(1)</sup> In one packing unit  $I_{Vmax}/I_{Vmin} \leq 1.6$

<b>OPTICAL AND ELECTRICAL CHARACTERISTICS</b> ( $T_{amb} = 25\text{ }^{\circ}\text{C}$ , unless otherwise specified) <b>VLMS20.., AMBER</b>							
PARAMETER	TEST CONDITION	PART	SYMBOL	MIN.	TYP.	MAX.	UNIT
Luminous intensity <sup>(1)</sup>	$I_F = 2\text{ mA}$	VLMS20J2L1	$I_V$	5.6	-	14	mcd
		VLMS20J2L2	$I_V$	5.6	-	18	mcd
		VLMS2000	$I_V$	7.1	16	-	mcd
		VLMS20K1L2	$I_V$	7.1	-	18	mcd
Dominant wavelength	$I_F = 2\text{ mA}$		$\lambda_d$	612	622	624	nm
Peak wavelength	$I_F = 2\text{ mA}$		$\lambda_p$	-	615	-	nm
Angle of half intensity	$I_F = 2\text{ mA}$		$\phi$	-	$\pm 60$	-	deg
Forward voltage	$I_F = 2\text{ mA}$		$V_F$	-	1.8	2.2	V
Reverse voltage	$I_R = 10\text{ }\mu\text{A}$		$V_R$	5	-	-	V
Junction capacitance	$V_R = 0\text{ V}$ , $f = 1\text{ MHz}$		$C_j$	-	15	-	pF

**Note**

<sup>(1)</sup> In one packing unit  $I_{Vmax}/I_{Vmin} \leq 1.6$



**OPTICAL AND ELECTRICAL CHARACTERISTICS** ( $T_{amb} = 25\text{ }^{\circ}\text{C}$ , unless otherwise specified)  
**VLMO20.., SOFT ORANGE**

PARAMETER	TEST CONDITION	PART	SYMBOL	MIN.	TYP.	MAX.	UNIT
Luminous intensity <sup>(1)</sup>	$I_F = 2\text{ mA}$	VLMO2000	$I_V$	4.5	9	-	mcd
		VLMO20J2M1	$I_V$	5.6	-	22.4	mcd
		VLMO20K1L2-34	$I_V$	7.1	-	18	mcd
		VLMO20K2L2-35	$I_V$	9	-	18	mcd
Dominant wavelength	$I_F = 2\text{ mA}$	VLMO20K1L2-34	$\lambda_d$	602	-	607	nm
		VLMO20K2L2-35	$\lambda_d$	602	-	609	nm
		VLMO20..	$\lambda_d$	598	605	611	nm
Peak wavelength	$I_F = 2\text{ mA}$		$\lambda_p$	-	610	-	nm
Angle of half intensity	$I_F = 2\text{ mA}$		$\phi$	-	$\pm 60$	-	deg
Forward voltage	$I_F = 2\text{ mA}$		$V_F$	-	1.8	2.2	V
Reverse voltage	$I_R = 10\text{ }\mu\text{A}$		$V_R$	5	-	-	V
Junction capacitance	$V_R = 0\text{ V}$ , $f = 1\text{ MHz}$		$C_j$	-	15	-	pF

**Note**

<sup>(1)</sup> In one packing unit  $I_{Vmax}/I_{Vmin} \leq 1.6$

**OPTICAL AND ELECTRICAL CHARACTERISTICS** ( $T_{amb} = 25\text{ }^{\circ}\text{C}$ , unless otherwise specified)  
**VLMY20.., YELLOW**

PARAMETER	TEST CONDITION	PART	SYMBOL	MIN.	TYP.	MAX.	UNIT
Luminous intensity <sup>(1)</sup>	$I_F = 2\text{ mA}$	VLMY2000	$I_V$	3.55	7.1	-	mcd
		VLMY20J1L2	$I_V$	4.5	-	18	mcd
		VLMY20K1L2	$I_V$	7.1	-	18	mcd
Dominant wavelength	$I_F = 2\text{ mA}$		$\lambda_d$	581	588	594	nm
Peak wavelength	$I_F = 2\text{ mA}$		$\lambda_p$	-	590	-	nm
Angle of half intensity	$I_F = 2\text{ mA}$		$\phi$	-	$\pm 60$	-	deg
Forward voltage	$I_F = 2\text{ mA}$		$V_F$	-	1.8	2.2	V
Reverse voltage	$I_R = 10\text{ }\mu\text{A}$		$V_R$	5	-	-	V
Junction capacitance	$V_R = 0\text{ V}$ , $f = 1\text{ MHz}$		$C_j$	-	15	-	pF

**Note**

<sup>(1)</sup> In one packing unit  $I_{Vmax}/I_{Vmin} \leq 1.6$

**OPTICAL AND ELECTRICAL CHARACTERISTICS** ( $T_{amb} = 25\text{ }^{\circ}\text{C}$ , unless otherwise specified)  
**VLMP20.., PURE GREEN**

PARAMETER	TEST CONDITION	PART	SYMBOL	MIN.	TYP.	MAX.	UNIT
Luminous intensity <sup>(1)</sup>	$I_F = 2\text{ mA}$	VLMP20D2G1	$I_V$	0.56	-	2.24	mcd
Dominant wavelength	$I_F = 2\text{ mA}$		$\lambda_d$	555	-	565	nm
Peak wavelength	$I_F = 2\text{ mA}$		$\lambda_p$	-	565	-	nm
Angle of half intensity	$I_F = 2\text{ mA}$		$\phi$	-	$\pm 60$	-	deg
Forward voltage	$I_F = 2\text{ mA}$		$V_F$	-	1.8	2.2	V
Reverse voltage	$I_R = 10\text{ }\mu\text{A}$		$V_R$	5	-	-	V
Junction capacitance	$V_R = 0\text{ V}$ , $f = 1\text{ MHz}$		$C_j$	-	15	-	pF

**Note**

<sup>(1)</sup> In one packing unit  $I_{Vmax}/I_{Vmin} \leq 1.6$



COLOR CLASSIFICATION								
GROUP	DOM. WAVELENGTH (nm)							
	SOFT ORANGE		YELLOW		AMBER		PURE GREEN	
	MIN.	MAX.	MIN.	MAX.	MIN.	MAX.	MIN.	MAX.
0	-	-	-	-	-	-	555	559
1	598	601	581	584	-	-	558	561
2	600	603	583	586	-	-	560	563
3	602	605	585	588	-	-	562	565
4	604	607	587	590	-	-	-	-
5	606	609	589	592	-	-	-	-
6	608	611	591	594	-	-	-	-
7	-	-	-	-	610	613	-	-
8	-	-	-	-	612	616	-	-
9	-	-	-	-	615	620	-	-
10	-	-	-	-	619	624	-	-

**Note**

- Wavelengths are tested at a current pulse duration of 25 ms.

LUMINOUS INTENSITY CLASSIFICATION			
GROUP	LUMINOUS INTENSITY I <sub>V</sub> (mcd)		
	STANDARD	OPTIONAL	MIN.
D	2	0.56	0.71
E	1	0.71	0.9
	2	0.9	1.12
F	1	1.12	1.4
	2	1.4	1.8
G	1	1.8	2.24
	2	2.24	2.8
H	1	2.8	3.55
	2	3.55	4.5
J	1	4.5	5.6
	2	5.6	7.1
K	1	7.1	9
	2	9	11.2
L	1	11.2	14
	2	14	18
M	1	18	22.4
	2	22.4	35.5
N	1	35.5	45
	2	45	56

**Note**

- Luminous intensity is tested at a current pulse duration of 25 ms and an accuracy of ± 11 %.
- The above type numbers represent the order groups which include only a few brightness groups. Only one group will be shipped on each reel (there will be no mixing of two groups on each reel).
- In order to ensure availability, single brightness groups will not be orderable.
- In a similar manner for colors where wavelength groups are measured and binned, single wavelength groups will be shipped in any one reel.
- In order to ensure availability, single wavelength groups will not be orderable.

CROSSING TABLE	
VISHAY	OSRAM
VLMS20H2K1	LSM67K-H2K1
VLMS20J2L1	LSM67K-J2L1
VLMS20H2L1	LSM67K-H2L1
VLMO20J2L1	LOM67K-J2L1
VLMO20J2M1	LOM67K-J2M1
VLMY20J1K2	LYM67K-J1K2
VLMY20K1L2	LYM67K-K1L2
VLMY20J1L2	LYM67K-J1L2
VLMP20D2G1	LPM67K-D2G1
VLMP20E2G1	LPM67K-E2G1

**TYPICAL CHARACTERISTICS** ( $T_{amb} = 25\text{ }^{\circ}\text{C}$ , unless otherwise specified)

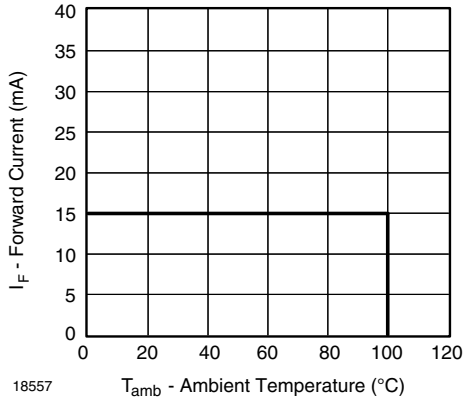

Fig. 1 - Forward Current vs. Ambient Temperature

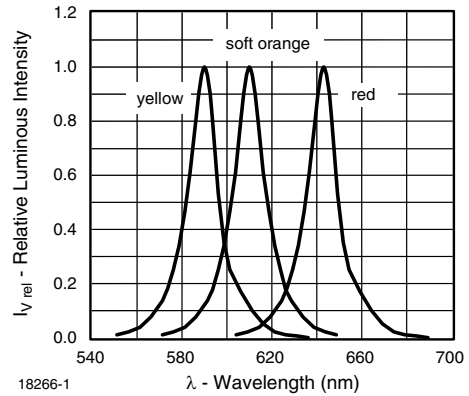

Fig. 4 - Relative Intensity vs. Wavelength



Fig. 2 - Forward Current vs. Pulse Length

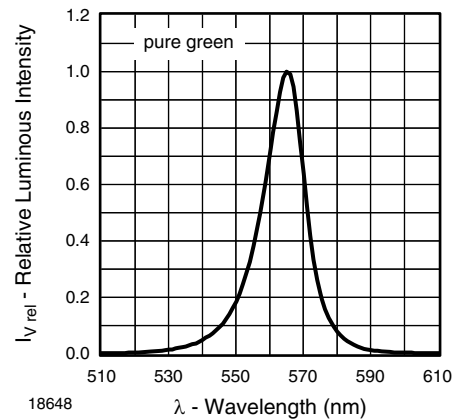

Fig. 5 - Relative Luminous Intensity vs. Wavelength

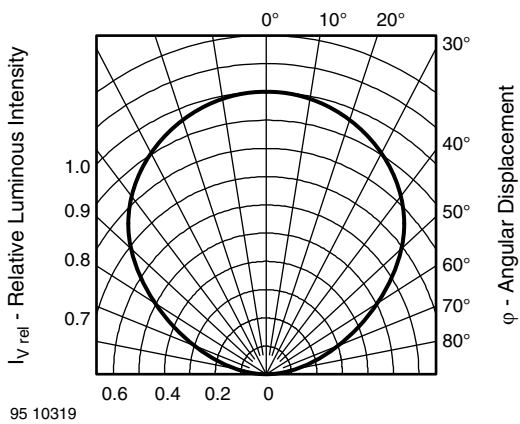

Fig. 3 - Relative Luminous Intensity vs. Angular Displacement

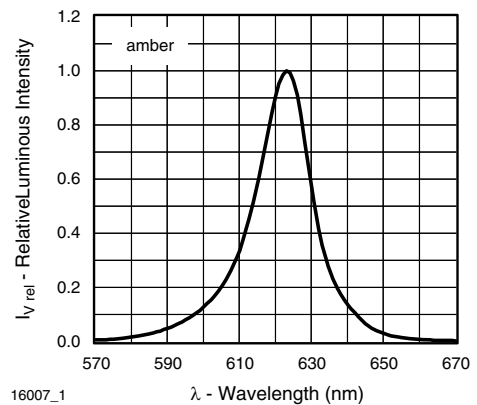

Fig. 6 - Relative Luminous Intensity vs. Wavelength



Fig. 7 - Forward Current vs. Forward Voltage



Fig. 10 - Forward Voltage vs. Ambient Temperature



Fig. 8 - Relative Luminous Intensity vs. Ambient Temperature



Fig. 11 - Change of Forward Voltage vs. Ambient Temperature

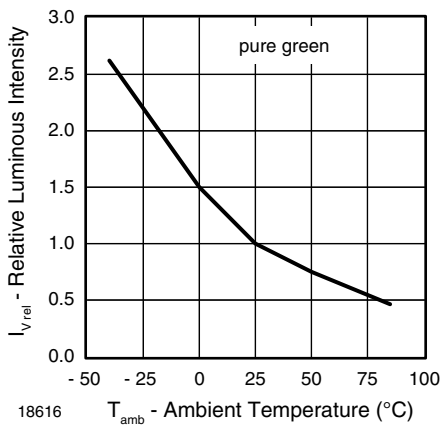

Fig. 9 - Relative Luminous Intensity vs. Ambient Temperature



PACKAGE DIMENSIONS in millimeters



Not indicated tolerances ± 0.2



Proposed pad layout (for reference only)



Drawing-No.: 6.541-5069.01-4  
Issue: 2; 24.11.14



**REEL DIMENSIONS** in millimeters



Drawing-No: 9.800-5051.V5-4  
 Issue: 1, 25.07.02  
 16938

**TAPE DIMENSIONS** in millimeters



Drawing-No: 9.700-5266.01-4  
 Issue: 1, 05.06.02  
 16939

**LEADER AND TRAILER DIMENSIONS** in millimeters



GS08 = 3000 pcs





**COVER TAPE PEEL STRENGTH**

According to DIN EN 60286-3  
 0.1 N to 1.3 N  
 300 mm/min ± 10 mm/min  
 165° to 180° peel angle

**LABEL**

**Standard bar code labels for finished goods**

The standard bar code labels are product labels and used for identification of goods. The finished goods are packed in final packing area. The standard packing units are labeled with standard bar code labels before transported as finished goods to warehouses. The labels are on each packing unit and contain Vishay Semiconductor GmbH specific data.

VISHAY SEMICONDUCTOR GmbH STANDARD BAR CODE PRODUCT LABEL (finished goods)		
PLAIN WRITING	ABBREVIATION	LENGTH
Item-description	-	18
Item-number	INO	8
Selection-code	SEL	3
LOT-/serial-number	BATCH	10
Data-code	COD	3 (YWW)
Plant-code	PTC	2
Quantity	QTY	8
Accepted by:	ACC	-
Packed by:	PCK	-
Mixed code indicator	MIXED CODE	-
Origin	xxxxxxx+	Company Logo
LONG BAR CODE TOP	TYPE	LENGTH
Item-number	N	8
Plant-code	N	2
Sequence-number	X	3
Quantity	N	8
Total length	-	21
SHORT BAR CODE BOTTOM	TYPE	LENGTH
Selection-code	X	3
Data-code	N	3
Batch-number	X	10
Filter	-	1
Total length	-	17

**SOLDERING PROFILE**

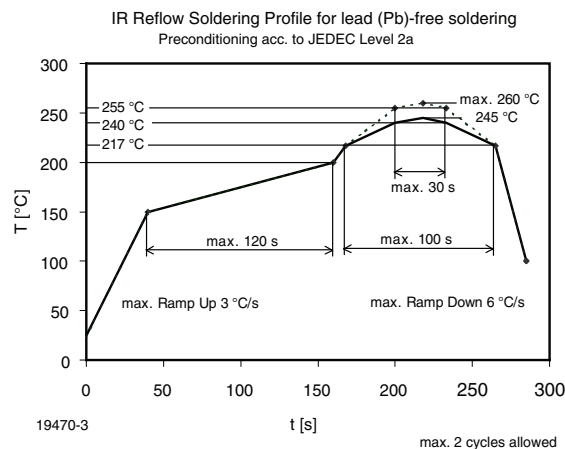
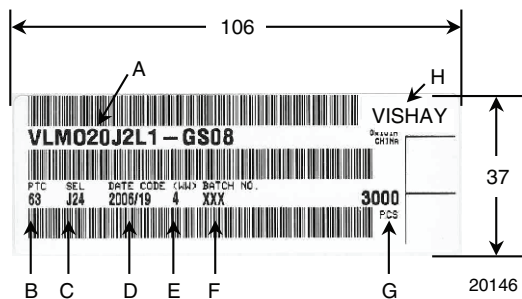

Fig. 12 - Vishay Lead (Pb)-free Reflow Soldering Profile (acc. to J-STD-020)



BAR CODE PRODUCT LABEL (example)



- A. Type of component
- B. Manufacturing plant
- C. SEL - selection code (bin):  
e.g.: J2 = code for luminous intensity group  
4 = code for color group
- D. Date code year / week
- E. Day code (e.g. 4: Thursday)
- F. Batch no.
- G. Total quantity
- H. Company code

DRY PACKING

The reel is packed in an anti-humidity bag to protect the devices from absorbing moisture during transportation and storage.

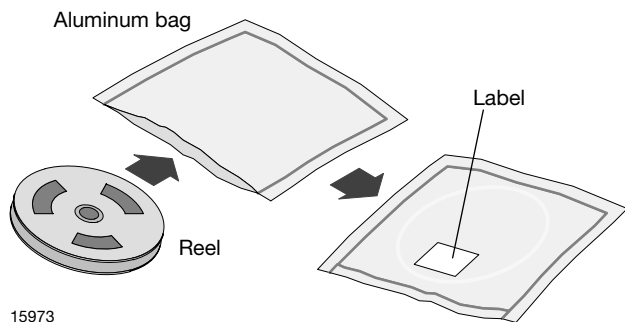

FINAL PACKING

The sealed reel is packed into a cardboard box. A secondary cardboard box is used for shipping purposes.

RECOMMENDED METHOD OF STORAGE

Dry box storage is recommended as soon as the aluminum bag has been opened to prevent moisture absorption. The following conditions should be observed, if dry boxes are not available:

- Storage temperature 10 °C to 30 °C
- Storage humidity ≤ 60 % RH max.

After more than 672 h under these conditions moisture content will be too high for reflow soldering.

In case of moisture absorption, the devices will recover to the former condition by drying under the following condition:  
192 h at 40 °C + 5 °C / - 0 °C and < 5 % RH (dry air/nitrogen) or  
96 h at 60 °C + 5 °C and < 5 % RH for all device containers or  
24 h at 100 °C + 5 °C not suitable for reel or tubes.

An EIA JEDEC standard JESD22-A112 level 2a label is included on all dry bags.

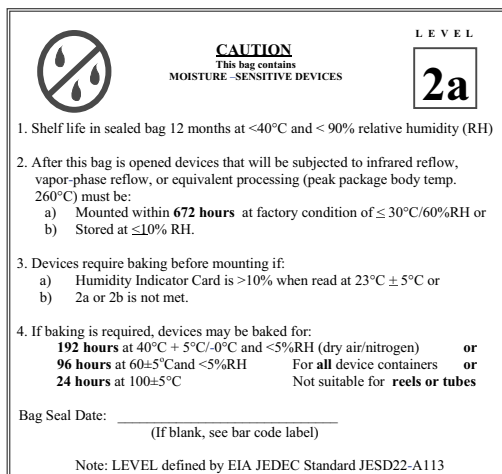

Example of JESD22-A112 level 2a label

ESD PRECAUTION

Proper storage and handling procedures should be followed to prevent ESD damage to the devices especially when they are removed from the antistatic shielding bag. Electrostatic sensitive devices warning labels are on the packaging.

VISHAY SEMICONDUCTORS STANDARD BAR CODE LABELS

The Vishay Semiconductors standard bar code labels are printed at final packing areas. The labels are on each packing unit and contain Vishay Semiconductors specific data.



## Disclaimer

ALL PRODUCT, PRODUCT SPECIFICATIONS AND DATA ARE SUBJECT TO CHANGE WITHOUT NOTICE TO IMPROVE RELIABILITY, FUNCTION OR DESIGN OR OTHERWISE.

Vishay Intertechnology, Inc., its affiliates, agents, and employees, and all persons acting on its or their behalf (collectively, "Vishay"), disclaim any and all liability for any errors, inaccuracies or incompleteness contained in any datasheet or in any other disclosure relating to any product.

Vishay makes no warranty, representation or guarantee regarding the suitability of the products for any particular purpose or the continuing production of any product. To the maximum extent permitted by applicable law, Vishay disclaims (i) any and all liability arising out of the application or use of any product, (ii) any and all liability, including without limitation special, consequential or incidental damages, and (iii) any and all implied warranties, including warranties of fitness for particular purpose, non-infringement and merchantability.

Statements regarding the suitability of products for certain types of applications are based on Vishay's knowledge of typical requirements that are often placed on Vishay products in generic applications. Such statements are not binding statements about the suitability of products for a particular application. It is the customer's responsibility to validate that a particular product with the properties described in the product specification is suitable for use in a particular application. Parameters provided in datasheets and/or specifications may vary in different applications and performance may vary over time. All operating parameters, including typical parameters, must be validated for each customer application by the customer's technical experts. Product specifications do not expand or otherwise modify Vishay's terms and conditions of purchase, including but not limited to the warranty expressed therein.

Except as expressly indicated in writing, Vishay products are not designed for use in medical, life-saving, or life-sustaining applications or for any other application in which the failure of the Vishay product could result in personal injury or death. Customers using or selling Vishay products not expressly indicated for use in such applications do so at their own risk. Please contact authorized Vishay personnel to obtain written terms and conditions regarding products designed for such applications.

No license, express or implied, by estoppel or otherwise, to any intellectual property rights is granted by this document or by any conduct of Vishay. Product names and markings noted herein may be trademarks of their respective owners.

## Material Category Policy

**Vishay Intertechnology, Inc. hereby certifies that all its products that are identified as RoHS-Compliant fulfill the definitions and restrictions defined under Directive 2011/65/EU of The European Parliament and of the Council of June 8, 2011 on the restriction of the use of certain hazardous substances in electrical and electronic equipment (EEE) - recast, unless otherwise specified as non-compliant.**

**Please note that some Vishay documentation may still make reference to RoHS Directive 2002/95/EC. We confirm that all the products identified as being compliant to Directive 2002/95/EC conform to Directive 2011/65/EU.**

**Vishay Intertechnology, Inc. hereby certifies that all its products that are identified as Halogen-Free follow Halogen-Free requirements as per JEDEC JS709A standards. Please note that some Vishay documentation may still make reference to the IEC 61249-2-21 definition. We confirm that all the products identified as being compliant to IEC 61249-2-21 conform to JEDEC JS709A standards.**



## Стандарт Электрон Связь

Мы молодая и активно развивающаяся компания в области поставок электронных компонентов. Мы поставляем электронные компоненты отечественного и импортного производства напрямую от производителей и с крупнейших складов мира.

Благодаря сотрудничеству с мировыми поставщиками мы осуществляем комплексные и плановые поставки широчайшего спектра электронных компонентов.

Собственная эффективная логистика и склад в обеспечивает надежную поставку продукции в точно указанные сроки по всей России.

Мы осуществляем техническую поддержку нашим клиентам и предпродажную проверку качества продукции. На все поставляемые продукты мы предоставляем гарантию .

Осуществляем поставки продукции под контролем ВП МО РФ на предприятия военно-промышленного комплекса России , а также работаем в рамках 275 ФЗ с открытием отдельных счетов в уполномоченном банке. Система менеджмента качества компании соответствует требованиям ГОСТ ISO 9001.

Минимальные сроки поставки, гибкие цены, неограниченный ассортимент и индивидуальный подход к клиентам являются основой для выстраивания долгосрочного и эффективного сотрудничества с предприятиями радиоэлектронной промышленности, предприятиями ВПК и научно-исследовательскими институтами России.

С нами вы становитесь еще успешнее!

### Наши контакты:

**Телефон:** +7 812 627 14 35

**Электронная почта:** [sales@st-electron.ru](mailto:sales@st-electron.ru)

**Адрес:** 198099, Санкт-Петербург,  
Промышленная ул, дом № 19, литера Н,  
помещение 100-Н Офис 331