



# Serially Controlled, Clickless Audio/Video Switches

MAX4571-MAX4574

## General Description

The MAX4571-MAX4574 serial-interface controlled switches are ideal for multimedia applications. Each device features 35Ω max on-resistance, -90dB audio off-isolation at 20kHz, -60dB video off-isolation at 1.0MHz, and "clickless" mode operation for audio applications.

The MAX4571/MAX4573 contain eleven SPST switches, while the MAX4572/MAX4574 contain two SPST switches and six SPDT switches. The MAX4571/MAX4572 feature a 2-wire, I<sup>2</sup>C™-compatible serial interface. The MAX4573/MAX4574 feature a 3-wire, SPI™/QSPI™/MICROWIRE™-compatible serial interface. All four parts are available in 28-pin QSOP, SSOP, and wide SO packages and operate over the commercial and extended temperature ranges.

## Applications

Set-Top Boxes                      Audio Systems  
 PC Multimedia Boards          Video Conferencing Systems

## Pin Configurations



## Features

- ◆ Selectable Soft Switching Mode for "Clickless" Audio Operation
- ◆ 35Ω max On-Resistance
- ◆ -90dB Audio Off-Isolation at 20kHz  
-50dB Video Off-Isolation at 10MHz
- ◆ -90dB Audio Crosstalk at 20kHz  
-52dB Video Crosstalk at 10MHz
- ◆ Serial Interface
  - 2-Wire, Fast-Mode, I<sup>2</sup>C-Compatible (MAX4571/72)
  - 3-Wire, SPI/QSPI/MICROWIRE-Compatible (MAX4573/74)
- ◆ Single-Supply Operation from +2.7V to +5.25V

## Ordering Information

PART	TEMP. RANGE	PIN-PACKAGE
<b>MAX4571</b> CEI	0°C to +70°C	28 QSOP
MAX4571CAI	0°C to +70°C	28 SSOP
MAX4571CWI	0°C to +70°C	28 Wide SO
MAX4571EEI	-40°C to +85°C	28 QSOP
MAX4571EAI	-40°C to +85°C	28 SSOP
MAX4571EWI	-40°C to +85°C	28 Wide SO
<b>MAX4572</b> CEI	0°C to +70°C	28 QSOP
MAX4572CAI	0°C to +70°C	28 SSOP
MAX4572CWI	0°C to +70°C	28 Wide SO
MAX4572EEI	-40°C to +85°C	28 QSOP
MAX4572EAI	-40°C to +85°C	28 SSOP
MAX4572EWI	-40°C to +85°C	28 Wide SO
<b>MAX4573</b> CEI	0°C to +70°C	28 QSOP
MAX4573CAI	0°C to +70°C	28 SSOP
MAX4573CWI	0°C to +70°C	28 Wide SO
MAX4573EEI	-40°C to +85°C	28 QSOP
MAX4573EAI	-40°C to +85°C	28 SSOP
MAX4573EWI	-40°C to +85°C	28 Wide SO
<b>MAX4574</b> CEI	0°C to +70°C	28 QSOP
MAX4574CAI	0°C to +70°C	28 SSOP
MAX4574CWI	0°C to +70°C	28 Wide SO
MAX4574EEI	-40°C to +85°C	28 QSOP
MAX4574EAI	-40°C to +85°C	28 SSOP
MAX4574EWI	-40°C to +85°C	28 Wide SO

I<sup>2</sup>C is a trademark of Philips Corp.

SPI/QSPI are trademarks of Motorola, Inc.

MICROWIRE is a trademark of National Semiconductor Corp.



# Serially Controlled, Clickless Audio/Video Switches

## ABSOLUTE MAXIMUM RATINGS

V+ to GND .....	-0.3V to +6V	SSOP (derate 9.5mW/°C above +70°C) .....	762mW
NO_-, COM_-, DOUT to GND (Note 1) .....	-0.3V to (V+ + 0.3V)	Wide SO (derate 12.5mW/°C above +70°C) .....	1000mW
SCL, SDA, CS, SCLK, DIN, A0, A1 to GND .....	-0.3V to +6V	Operating Temperature Ranges	
Continuous Current into Any Terminal .....	±10mA	MAX457_C_ .....	0°C to +70°C
Peak Current (pulsed at 1ms, 10% duty cycle) .....	±50mA	MAX457_E_ .....	-40°C to +85°C
Continuous Power Dissipation (TA = +70°C)		Storage Temperature Range .....	-65°C to +160°C
QSOP (derate 10.8mW/°C above +70°C) .....	860mW	Lead Temperature (soldering, 10sec) .....	+300°C

**Note 1:** Signals on NO\_ or COM\_ exceeding V+ or V- are clamped by internal diodes. Limit forward-diode current to maximum current rating.

Stresses beyond those listed under "Absolute Maximum Ratings" may cause permanent damage to the device. These are stress ratings only, and functional operation of the device at these or any other conditions beyond those indicated in the operational sections of the specifications is not implied. Exposure to absolute maximum rating conditions for extended periods may affect device reliability.

## ELECTRICAL CHARACTERISTICS—Single +5V Supply

(V+ = +5V ±5%, TA = TMIN to TMAX, unless otherwise noted. Typical values are at TA = +25°C.) (Note 2)

PARAMETER	SYMBOL	CONDITIONS	MIN	TYP	MAX	UNITS	
<b>ANALOG SWITCHES</b>							
Analog Signal Range (Note 3)	VNO_-, VCOM_-		0		V+	V	
On-Resistance	RON	ICOM_- = 4mA, VNO_- = 3V, V+ = 4.75V	TA = +25°C	25	35	Ω	
			TA = TMIN to TMAX		45		
On-Resistance Match Between Channels (Note 4)	ΔRON	ICOM_- = 4mA, VNO_- = 3V, V+ = 4.75V	TA = +25°C	0.8	3	Ω	
			TA = TMIN to TMAX		3		
On-Resistance Flatness (Note 5)	RFLAT	ICOM_- = 4mA; V+ = 4.75V; VNO_- = 1V, 2V, 3V	TA = +25°C	2	6	Ω	
			TA = TMIN to TMAX		6		
NO_- Off-Leakage Current (Note 6)	INO_- (OFF)	VNO_- = 4.5V, 1V; VCOM_- = 1V, 4.5V; V+ = 5.25V	TA = +25°C	-0.2	0.01	0.2	nA
			TA = TMIN to TMAX	-10		10	
COM_- Off-Leakage Current (Note 6)	ICOM_- (OFF)	VNO_- = 4.5V, 1V; VCOM_- = 1V, 4.5V; V+ = 5.25V	TA = +25°C	-0.2	0.01	0.2	nA
			TA = TMIN to TMAX	-10		10	
COM_- On-Leakage Current (Note 6)	ICOM_- (ON)	VCOM_- = 4.5V, 1V; VNO_- = 4.5V, 1V, or floating; V+ = 5.25V	TA = +25°C	-0.2	0.01	0.2	nA
			TA = TMIN to TMAX	-10		10	
<b>AUDIO PERFORMANCE</b>							
Total Harmonic Distortion plus Noise	THD+N	fIN = 1kHz, RL = 600Ω, VNO_- = 1VRMS, VNO_- = 2.5V		0.07		%	
Off-Isolation (Note 7)	VISO(A)	VNO_- = 1VRMS, fIN = 20kHz, RL = 600Ω, Figure 1		-90		dB	
Channel-to-Channel Crosstalk	VCT(A)	VNO_- = 1VRMS, fIN = 20kHz, RS = 600Ω, Figure 1		-90		dB	

# Serially Controlled, Clickless Audio/Video Switches

MAX4571-MAX4574

## ELECTRICAL CHARACTERISTICS—Single +5V Supply (continued)

(V+ = 5V ±5%, T<sub>A</sub> = T<sub>MIN</sub> to T<sub>MAX</sub>, unless otherwise noted. Typical values are at T<sub>A</sub> = +25°C.) (Note 2)

PARAMETER	SYMBOL	CONDITIONS	MIN	TYP	MAX	UNITS
<b>VIDEO PERFORMANCE</b>						
Off-Isolation (Note 7)	V <sub>ISO(V)</sub>	V <sub>NO--</sub> = 1V <sub>RMS</sub> , f <sub>IN</sub> = 1.0MHz, R <sub>L</sub> = 50Ω, Figure 1		-50		dB
Channel-to-Channel Crosstalk	V <sub>CT(V)</sub>	V <sub>NO--</sub> = 1V <sub>RMS</sub> , f <sub>IN</sub> = 1.0MHz, R <sub>S</sub> = 50Ω, Figure 1		-52		dB
-3dB Bandwidth	BW	R <sub>SOURCE</sub> = 50Ω, R <sub>L</sub> = 50Ω		>150		MHz
Off-Capacitance	C <sub>OFF(NO)</sub>	f <sub>IN</sub> = 1MHz		9		pF
<b>DYNAMIC TIMING WITH CLICKLESS MODE DISABLED</b> (Notes 8 and 12, Figure 2)						
Turn-On Time	t <sub>ONSD</sub>	V <sub>NO--</sub> = 1.5V, R <sub>L</sub> = 5kΩ, C <sub>L</sub> = 35pF	T <sub>A</sub> = +25°C	200	500	ns
			T <sub>A</sub> = T <sub>MIN</sub> to T <sub>MAX</sub>			
Turn-Off Time	t <sub>OFFSD</sub>	V <sub>NO--</sub> = 1.5V, R <sub>L</sub> = 300Ω, C <sub>L</sub> = 35pF	T <sub>A</sub> = +25°C	75	300	ns
			T <sub>A</sub> = T <sub>MIN</sub> to T <sub>MAX</sub>			
Break-Before-Make Time	t <sub>BBM</sub>	MAX4572/MAX4574, V <sub>NO--</sub> = 1.5V, T <sub>A</sub> = T <sub>MIN</sub> to T <sub>MAX</sub>	10	125		ns
<b>DYNAMIC TIMING WITH CLICKLESS MODE ENABLED</b> (Note 8, Figure 2)						
Turn-On Time	t <sub>ONSE</sub>	V <sub>NO--</sub> = 1.5V, R <sub>L</sub> = 5kΩ, C <sub>L</sub> = 35pF, T <sub>A</sub> = +25°C		8		ms
Turn-Off Time	t <sub>OFFSE</sub>	V <sub>NO--</sub> or = 1.5V, R <sub>L</sub> = 300Ω, C <sub>L</sub> = 35pF, T <sub>A</sub> = +25°C		3		ms
<b>POWER SUPPLY</b>						
Supply Voltage Range	V+	T <sub>A</sub> = T <sub>MIN</sub> to T <sub>MAX</sub>	+2.7		+5.25	V
Supply Current (Note 9)	I+	All logic inputs = 0 or V+, T <sub>A</sub> = T <sub>MIN</sub> to T <sub>MAX</sub>		6	10	μA

## ELECTRICAL CHARACTERISTICS—Single +3V Supply

(V+ = 3V ±10%, T<sub>A</sub> = T<sub>MIN</sub> to T<sub>MAX</sub>, unless otherwise noted. Typical values are at T<sub>A</sub> = +25°C.) (Note 2)

PARAMETER	SYMBOL	CONDITIONS	MIN	TYP	MAX	UNITS
<b>ANALOG SWITCHES</b>						
Analog Signal Range (Note 3)	V <sub>NO--</sub> , V <sub>COM--</sub>		0		V+	V
On-Resistance	R <sub>ON</sub>	I <sub>COM--</sub> = 4mA, V <sub>NO--</sub> = 2V, V+ = 2.7V	T <sub>A</sub> = +25°C	43	90	Ω
			T <sub>A</sub> = T <sub>MIN</sub> to T <sub>MAX</sub>			
On-Resistance Match Between Channels (Note 4)	ΔR <sub>ON</sub>	I <sub>COM--</sub> = 4mA, V <sub>NO--</sub> = 2V, V+ = 2.7V	T <sub>A</sub> = +25°C	1	5	Ω
			T <sub>A</sub> = T <sub>MIN</sub> to T <sub>MAX</sub>			

# Serially Controlled, Clickless Audio/Video Switches

## ELECTRICAL CHARACTERISTICS—Single +3V Supply (continued)

(V+ = +3V ±10%, T<sub>A</sub> = T<sub>MIN</sub> to T<sub>MAX</sub>, unless otherwise noted. Typical values are at T<sub>A</sub> = +25°C.) (Note 2)

PARAMETER	SYMBOL	CONDITIONS		MIN	TYP	MAX	UNITS
On-Resistance Flatness (Note 5)	R <sub>FLAT</sub>	I <sub>COM_</sub> = 4mA; V+ = 2.7V; V <sub>NO_</sub> = 1V, 5V, 2V	T <sub>A</sub> = +25°C		4	10	Ω
			T <sub>A</sub> = T <sub>MIN</sub> to T <sub>MAX</sub>			10	
NO_ Off-Leakage Current (Notes 6 and 10)	I <sub>NO_</sub> (OFF)	V <sub>NO_</sub> = 3V, 0.5V; V <sub>COM_</sub> = 0.5V, 3V; V+ = 3.6V	T <sub>A</sub> = +25°C	-0.2	0.01	0.2	nA
			T <sub>A</sub> = T <sub>MIN</sub> to T <sub>MAX</sub>	-10		10	
COM_ Off-Leakage Current (Notes 6 and 10)	I <sub>COM_</sub> (OFF)	V <sub>NO_</sub> = 3V, 0.5V; V <sub>COM_</sub> = 0.5V, 3V; V+ = 3.6V	T <sub>A</sub> = +25°C	-0.2	0.01	0.2	nA
			T <sub>A</sub> = T <sub>MIN</sub> to T <sub>MAX</sub>	-10		10	
COM_ On-Leakage Current (Notes 6 and 10)	I <sub>COM_</sub> (ON)	V <sub>COM_</sub> = 3V, 0.5V; V <sub>NO_</sub> = 3V, 0.5V, or floating; V+ = 3.6V	T <sub>A</sub> = +25°C	-0.2	0.01	0.2	nA
			T <sub>A</sub> = T <sub>MIN</sub> to T <sub>MAX</sub>	-10		10	
<b>AUDIO PERFORMANCE</b>							
Total Harmonic Distortion plus Noise	THD+N	f <sub>IN</sub> = 1kHz, R <sub>L</sub> = 600Ω, V <sub>NO_</sub> = 0.5V <sub>RMS</sub> , V <sub>NO_</sub> = 1.5V			0.07		%
Off-Isolation (Note 7)	V <sub>ISO(A)</sub>	V <sub>NO_</sub> = 0.5V <sub>RMS</sub> , f <sub>IN</sub> = 20kHz, R <sub>L</sub> = 600Ω, Figure 1			-90		dB
Channel-to-Channel Crosstalk	V <sub>CT(A)</sub>	V <sub>NO_</sub> = 0.5V <sub>RMS</sub> , f <sub>IN</sub> = 20kHz, R <sub>S</sub> = 600Ω, Figure 1			-90		dB
<b>VIDEO PERFORMANCE</b>							
Off-Isolation (Note 7)	V <sub>ISO(V)</sub>	V <sub>NO_</sub> = 0.5V <sub>RMS</sub> , f <sub>IN</sub> = 10MHz, R <sub>L</sub> = 50Ω, Figure 1			-50		dB
Channel-to-Channel Crosstalk	V <sub>CT(V)</sub>	V <sub>NO_</sub> = 0.5V <sub>RMS</sub> , f <sub>IN</sub> = 10MHz, R <sub>S</sub> = 50Ω, Figure 1			-52		dB
-3dB Bandwidth	BW	R <sub>SOURCE</sub> = 50Ω, R <sub>L</sub> = 50Ω, C <sub>L</sub> = 35pF			>150		MHz
Off Capacitance	C <sub>OFF(NO)</sub>	f <sub>IN</sub> = 1MHz			9		pF
<b>DYNAMIC TIMING WITH CLICKLESS MODE DISABLED</b> (Notes 8 and 12, Figure 2)							
Turn-On Time	t <sub>ONSD</sub>	V <sub>NO_</sub> = 1.5V, R <sub>L</sub> = 5kΩ, C <sub>L</sub> = 35pF	T <sub>A</sub> = +25°C		300	900	ns
			T <sub>A</sub> = T <sub>MIN</sub> to T <sub>MAX</sub>			1000	
Turn-Off Time	t <sub>OFFSD</sub>	V <sub>NO_</sub> = 1.5V, R <sub>L</sub> = 300Ω, C <sub>L</sub> = 35pF	T <sub>A</sub> = +25°C		100	300	ns
			T <sub>A</sub> = T <sub>MIN</sub> to T <sub>MAX</sub>			400	
Break-Before-Make Time	t <sub>BBM</sub>	V <sub>NO_</sub> = 1.5V, T <sub>A</sub> = T <sub>MIN</sub> to T <sub>MAX</sub>		10	200		ns
<b>DYNAMIC TIMING WITH CLICKLESS MODE ENABLED</b> (Notes 8 and 12, Figure 2)							
Turn-On Time	t <sub>ONSE</sub>	V <sub>NO_</sub> = 1.5V, R <sub>L</sub> = 5kΩ, C <sub>L</sub> = 35pF, T <sub>A</sub> = +25°C			8		ms
Turn-Off Time	t <sub>OFFSE</sub>	V <sub>NO_</sub> = 1.5V, R <sub>L</sub> = 300Ω, C <sub>L</sub> = 35pF, T <sub>A</sub> = +25°C			3		ms

# Serially Controlled, Clickless Audio/Video Switches

MAX4571-MAX4574

## I/O INTERFACE CHARACTERISTICS

(V+ = +2.7V to +5.25V, T<sub>A</sub> = T<sub>MIN</sub> to T<sub>MAX</sub>, unless otherwise noted. Typical values are at T<sub>A</sub> = +25°C.)

PARAMETER	SYMBOL	CONDITIONS	MIN	TYP	MAX	UNITS
<b>DIGITAL INPUTS (SCLK, DIN, CS, SCL, SDA, A0, A1)</b>						
Input Low Voltage	V <sub>IL</sub>	V+ = 5V			0.8	V
		V+ = 3V			0.6	
Input High Voltage	V <sub>IH</sub>	V+ = 5V	3			V
		V+ = 3V	2			
Input Hysteresis	V <sub>HYST</sub>			0.2		V
Input Leakage Current	I <sub>LEAK</sub>	Digital inputs = 0 or V+	-1	0.01	1	μA
Input Capacitance	C <sub>IN</sub>			5		pF
<b>DIGITAL OUTPUTS (DOUT, SDA)</b>						
Output Low Voltage	V <sub>OL</sub>	I <sub>SINK</sub> = 6mA			0.4	V
DOUT Output High Voltage	V <sub>OH</sub>	I <sub>SOURCE</sub> = 0.5mA	V+		-0.5	V
<b>2-WIRE INTERFACE TIMING (Figure 3)</b>						
SCL Clock Frequency	f <sub>SCL</sub>		DC		400	kHz
Bus Free Time between Stop and Start Condition	t <sub>BUF</sub>		1.3			μs
START Condition Hold Time	t <sub>HD:STA</sub>		0.6			μs
STOP Condition Setup Time	t <sub>SU:STO</sub>		0.6			μs
Data Hold Time	t <sub>HD:DAT</sub>		0		0.9	μs
Data Setup Time	t <sub>SU:DAT</sub>		100			ns
Clock Low Period	t <sub>LOW</sub>		1.3			μs
Clock High Period	t <sub>HIGH</sub>		0.6			μs
SCL/SDA Rise Time	t <sub>R</sub>	(Note 11)	20 + 0.1C <sub>b</sub>		300	ns
SCL/SDA Fall Time	t <sub>F</sub>	(Note 11)	20 + 0.1C <sub>b</sub>		300	ns
<b>3-WIRE TIMING (Figure 5)</b>						
Operating Frequency	f <sub>OP</sub>		DC		2.1	MHz
DIN to SCLK Setup	t <sub>DS</sub>		100			ns
DIN to SCLK Hold	t <sub>DH</sub>				0	ns
SCLK Fall to Output Data Valid	t <sub>DO</sub>	C <sub>LOAD</sub> = 50pF	20		200	ns
CS to SCLK Rise Setup	t <sub>CSS</sub>		100			ns
CS to SCLK Rise Hold	t <sub>CSSH</sub>		0			ns
CS High Pulse Width	t <sub>Csw</sub>		200			ns
SCLK Pulse Width Low	t <sub>CL</sub>		200			ns
SCLK Pulse Width High	t <sub>CH</sub>		200			ns
Rise Time (SCLK, DIN, CS)	t <sub>R</sub>				2	μs
Fall Time (SCLK, DIN, CS)	t <sub>F</sub>				2	μs

# Serially Controlled, Clickless Audio/Video Switches

- Note 2:** The algebraic convention is used in this data sheet; the most negative value is shown in the minimum column.
- Note 3:** Guaranteed by design. Not subject to production testing.
- Note 4:**  $\Delta R_{ON} = R_{ON(MAX)} - R_{ON(MIN)}$ .
- Note 5:** Resistance flatness is defined as the difference between the maximum and minimum on-resistance values, as measured over the specified analog signal range.
- Note 6:** Leakage parameters are 100% tested at maximum rated temperature, and guaranteed by correlation at  $T_A = +25^\circ\text{C}$ .
- Note 7:** Off-isolation =  $20 \log [V_{COM\_} / V_{NO\_}]$ ,  $V_{COM\_}$  = output,  $V_{NO\_}$  = input to off switch.
- Note 8:** All timing is measured from the rising clock edge of the ACK bit for 2-wire, and from the rising edge of  $\overline{CS}$  for 3-wire. Turn-off time is defined at the output of the switch for a 0.5V change, tested with a  $300\Omega$  load to ground. Turn-on time is measured with a  $5k\Omega$  load resistor to GND. All timing is shown with respect to 20%  $V_+$  and 70%  $V_+$ , unless otherwise noted.
- Note 9:** Supply current can be as high as 2mA per switch during switch transitions in the clickless mode, corresponding to a 28mA total supply transient current requirement.
- Note 10:** Leakage testing for single-supply operation is guaranteed by testing with a single +5.25V supply.
- Note 11:**  $C_b$  = capacitance of one bus line in pF. Tested with  $C_b = 400\text{pF}$ .
- Note 12:** Typical values are for MAX4573/MAX4574 devices.

## Typical Operating Characteristics

( $V_+ = +5\text{V}$ ,  $T_A = +25^\circ\text{C}$ , unless otherwise noted.)



# Serially Controlled, Clickless Audio/Video Switches

## Typical Operating Characteristics (continued)

( $V_+ = 5V, T_A = +25^\circ C$ , unless otherwise noted.)

MAX4571-MAX4574

**TOTAL HARMONIC DISTORTION + NOISE vs. FREQUENCY**



**AUDIO FREQUENCY RESPONSE**

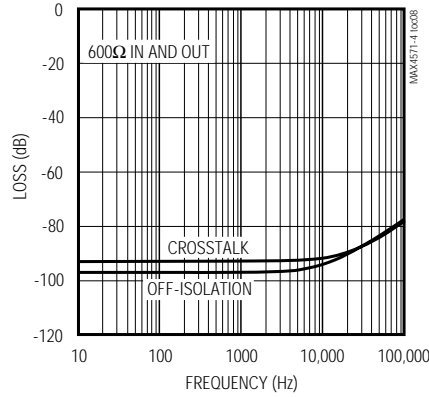

**VIDEO FREQUENCY RESPONSE**

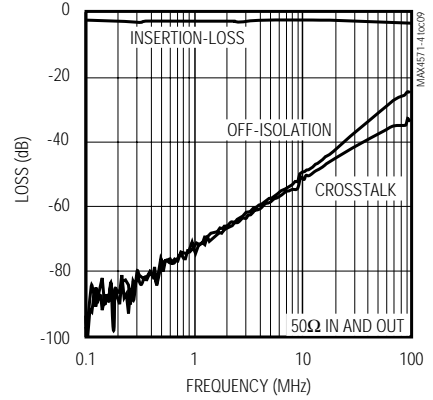

**ON/OFF TIMES (SOFT MODE)**

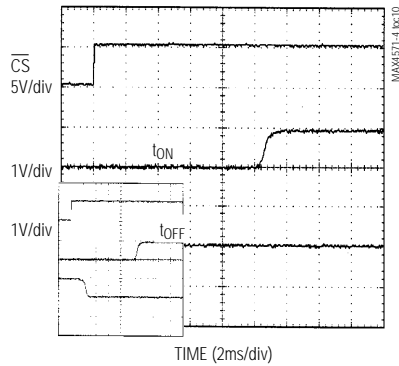

**ON/OFF TIMES (HARD MODE)**

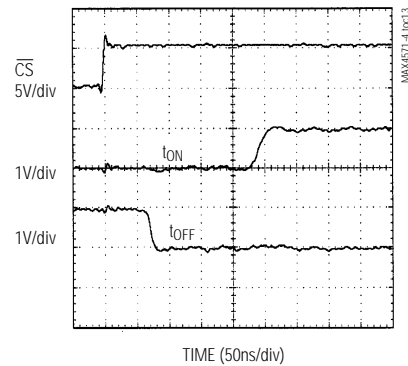

**SOFT MODE RISE TIME**

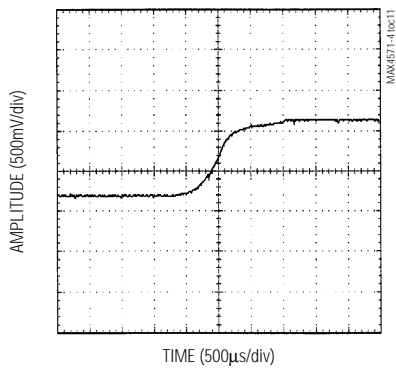

**SOFT MODE FALL TIME**

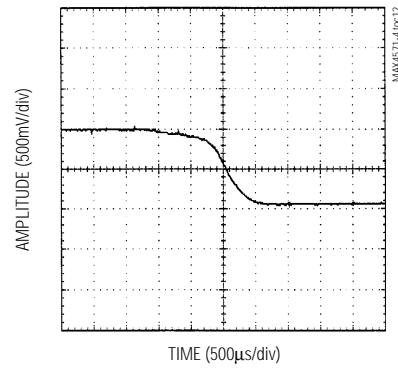

# Serially Controlled, Clickless Audio/Video Switches

## Pin Descriptions

PIN		NAME		FUNCTION
MAX4571	MAX4572	MAX4571	MAX4572	
1, 3, 5, 7, 9, 11, 13, 22, 20, 18, 16	-	NO1-NO11	-	Normally Open Terminals
-	1, 4, 7, 10	-	NO1A-NO4A	Normally Open Terminals
-	3, 6, 9, 12	-	NO1B-NO4B	Normally Open Terminals
-	13, 16	-	NO5, NO8	Normally Open Terminals
-	22, 19, 20, 17	-	NO6A, NO7A, NO6B, NO7B	Normally Open Terminals
2, 4, 6, 8, 10, 12, 14, 21, 19, 17, 15	2, 5, 8, 11, 14, 21, 18, 15	COM1-COM11	COM1-COM8	Common Terminals
23	23	GND	GND	Ground
24	24	A0	A0	LSB + 1 of 2-Wire Serial Interface Address Field
25	25	A1	A1	LSB + 2 of 2-Wire Serial Interface Address Field
26	26	SCL	SCL	Clock Input of 2-Wire Serial Interface
27	27	SDA	SDA	Data Input of 2-Wire Serial Interface
28	28	V+	V+	Positive Supply Voltage

PIN		NAME		FUNCTION
MAX4573	MAX4574	MAX4573	MAX4574	
1, 3, 5, 7, 9, 11, 13, 22, 20, 18, 16	-	NO1-NO11	-	Normally Open Terminals
-	1, 4, 7, 10	-	NO1A-NO4A	Normally Open Terminals
-	3, 6, 9, 12	-	NO1B-NO4B	Normally Open Terminals
-	13, 16	-	NO5, NO8	Normally Open Terminals
-	22, 19, 20, 17	-	NO6A, NO7A, NO6B, NO7B	Normally Open Terminals
2, 4, 6, 8, 10, 12, 14, 21, 19, 17, 15	2, 5, 8, 11, 14, 21, 18, 15	COM1-COM11	COM1-COM8	Common Terminals
23	23	GND	GND	Ground
24	24	$\overline{CS}$	$\overline{CS}$	Chip Select of 3-Wire Serial Interface
25	25	SCLK	SCLK	Clock Input of 3-Wire Serial Interface
26	26	DIN	DIN	Clock Input of 3-Wire Serial Interface
27	27	DOUT	DOUT	Data Output of 3-Wire Serial Interface
28	28	V+	V+	Positive Supply Voltage



# Serially Controlled, Clickless Audio/Video Switches

MAX4571-MAX4574



Figure 1. Off-Isolation and Crosstalk



Figure 2. Switching Time

# Serially Controlled, Clickless Audio/Video Switches

## Detailed Description

The MAX4571-MAX4574 are serial-interface controlled switches with soft-mode “clickless” and hard-mode operating capability. The MAX4571/MAX4573 contain 11 SPST switches, while the MAX4572/MAX4574 contain two SPST switches and six SPDT switches. The SPDT switches are actually 2-to-1 multiplexers, in that each SPDT is really two independent SPST switches with a common node, as shown in the *Pin Configurations*. Each switch is controlled independently by either the SPI or I<sup>2</sup>C interface.

Audio off-isolation is -90dB at 20kHz, crosstalk is at least -90dB at 20kHz, and video off-isolation is at least -50dB at 10MHz.

Each switch of any device may be set to operate in either soft or hard mode. In soft mode, the switching transition is slowed to avoid the audible “clicking” that can occur when switches are used to route audio signals. In hard mode, the switches are not slowed down, making this mode useful when a faster response is required. If a new command is issued while any soft-mode switch is transitioning, the switch transition time is decreased so it reaches its final state before the new command is executed. Soft mode is the power-up default state for all switches. Switches in the same mode are guaranteed to be break-before-make relative to each other. Break-before-make does not apply between switches operating in different modes.

These devices operate from a single supply of +2.7V to +5.25V. The MAX4571/MAX4572 feature a 2-wire, I<sup>2</sup>C-compatible serial interface, and the MAX4573/MAX4574 feature a 3-wire, SPI/QSPI/MICROWIRE-compatible serial interface.

## Applications Information

### Switch Control

The MAX4571-MAX4574 have a common command and control-bit structure, the differences being only in the interface type (2-wire or 3-wire) and in the switch configurations.

The SWITCHSET command controls the open/closed states of the various switches. MODESET controls soft/hard-mode states of the switches. There are also NO\_OP and RESET commands. The NO\_OP command is useful for daisy-chaining multiple 3-wire parts. The RESET command places a device in a state identical to its power-up state, with all switches open and in soft switching mode.

Table 1 shows the configuration of the command bits and their related commands. Table 2 shows the configuration of the command bits and their related commands. *SendByte* and *WriteWord* are trademarks of Philips Corp.

uration of the data bits and their related switches. The arrangement of the command bits and the data bits depends on the interface type (2-wire or 3-wire). After a SWITCHSET command is issued, a logic 1 in any data-bit location closes the associated switch, while a logic 0 opens it. After a MODESET command, a logic 1 in any data-bit location sets the associated switch into hard mode, while a logic 0 sets it into soft mode.

### 2-Wire Serial Interface

The MAX4571/MAX4572 use a 2-wire, I<sup>2</sup>C-compatible serial interface requiring only two I/O lines of a standard microprocessor port for communication. These devices use the *SendByte*<sup>™</sup> and *WriteWord*<sup>™</sup> protocols. The *SendByte* protocol is used only for the RESET command. The *WriteWord* protocol is used for the MODESET and SWITCHSET commands.

The first byte of any 2-wire serial-interface transaction is always the address byte. To address a given chip, the A0 and A1 bits in the address byte (Table 3) must duplicate the values present at the A0 and A1 pins of that chip, and the rest of the address bits must be configured as shown in Table 3. Connect the A0 and A1 pins to V+ or to GND, or drive them with CMOS logic levels.

The second byte is the command byte. The possible commands are RESET, MODESET, and SWITCHSET. RESET sets all switches to the initial power-up state (open and in soft switching mode). The RESET command is executed on the rising clock edge of the acknowledge bit after the command byte. The MODESET and SWITCHSET commands are each followed by two data bytes. The first data byte is buffered so all the data latches switch together. MODESET and SWITCHSET are executed on the rising clock edge of the acknowledge bit after the second data byte. Table 3 details the 2-wire interface data structure. Figures 3 and 4 and the *I/O Interface Characteristics* detail the timing of the 2-wire serial-interface protocol. All bytes of the transmission, whether address, command, or data, are sent MSB first.

The MAX4571/MAX4572 are receive-only devices and must be controlled by a bus master device. A bus master signals the beginning of a transmission with a start condition by transitioning SDA from high to low while SCL is high. The slave devices monitor the serial bus continuously, waiting for a start condition followed by an address byte. When a device recognizes its address byte, it acknowledges by pulling the SDA line low for one clock period; it is then ready to accept command and data bytes. The device then issues a similar acknowledgment after the command byte, and again after each data byte. When the master has finished

# Serially Controlled, Clickless Audio/Video Switches

**Table 1. Command Bit Mapping**

MSB	MSB - 1	COMMAND	DESCRIPTION
0	0	RESET	Sets all switches open and in soft switching mode.
0	1	MODESET	Sets specified switches to soft or hard mode.
1	0	NO_OP	No Operation.
1	1	SWITCHSET	Sets specified switches open or closed.

**Table 2. Data-Bit Switch Control**

DATA BIT	MAX4571/MAX4573		MAX4572/MAX4574	
	SWITCH	SWITCH TERMINALS	SWITCH	SWITCH TERMINALS
D13	X	X	SW8	15, 16
D12	X	X	SW5	13, 14
D11	X	X	SW7B	17, 18
D10	SW11	15, 16	SW7A	18, 19
D9	SW10	17, 18	SW6B	20, 21
D8	SW9	19, 20	SW6A	21, 22
D7	SW8	21, 22	SW4B	11, 12
D6	SW7	13, 14	SW4A	10, 11
D5	SW6	11, 12	SW3B	8, 9
D4	SW5	9, 10	SW3A	7, 8
D3	SW4	7, 8	SW2B	5, 6
D2	SW3	5, 6	SW2A	4, 5
D1	SW2	3, 4	SW1B	2, 3
D0 (LSB)	SW1	1, 2	SW1A	1, 2

X = Don't care

communicating with the slave, it issues a stop condition by transitioning SDA from low to high while SCL is high. The bus is then free for another transmission.

### 3-Wire Serial Interface

The MAX4573/MAX4574 use a 3-wire SPI/QSPI/MICROWIRE-compatible serial interface. An active-low chip-select pin,  $\overline{CS}$ , enables the device to receive data from the serial input pin, DIN. Command and data information are clocked in on the rising edge of the serial-clock signal (SCLK) MSB first. A total of 16 bits are needed in each write cycle. The write cycle allows two 8-bit-wide transfers if  $\overline{CS}$  remains low for the entire 16 bits. The command code is contained in the two MSBs of the 16-bit word. The remaining bits control the switches as shown in Table 4. While shifting in the serial data, the device remains in its original configuration. A rising edge on  $\overline{CS}$  latches the data into the MAX4573/MAX4574 internal registers, initiating the device's change of state. Table 4 shows the details of the 3-wire interface data structure.

Figures 5 and 6 and the *I/O Interface Characteristics* show the timing details of the 3-wire interface. If the two command bits initiate a SWITCHSET command, a logic 1 in a switch control location closes the associated switch, while a logic 0 opens it. If the command bits initiate a MODESET command, a logic 1 in a switch control location sets the associated switch into hard mode, while a logic 0 sets it into soft, "clickless" mode. For command-bit configurations, see Table 1.

### Using Multiple Devices

There are two ways to connect multiple devices to the same 3-wire serial interface. The first involves using the DOUT pin. DOUT presents a copy of the last bit of the internal shift register, useful for daisy-chaining multiple devices. Data at DOUT are simply the input data delayed by 16 clock cycles, appearing synchronous with SCLK's falling edge. After  $\overline{CS}$  goes high, DOUT holds the last bit in the shift register until new data are shifted into DIN. For a simple interface using several MAX4573/MAX4574 devices, daisy-chain the shift reg-

# Serially Controlled, Clickless Audio/Video Switches

**Table 3. 2-Wire Serial-Interface Data Format**

**RESET Command**

Address Byte										Command Byte (RESET)									
MSB					LSB					MSB				LSB					
S	0	1	1	0	1	A	A	0	A	0	0	X	X	X	X	X	X	A	S
R						1	0		C								C	T	
T									K								K	P	

**SWITCHSET Command**

Address Byte										Command Byte (SWITCHSET)									
MSB					LSB					MSB				LSB					
S	0	1	1	0	1	A	A	0	A	1	1	X	X	X	X	X	X	A	S
R						1	0		C									C	T
T									K									K	P

**MAX4571**

First Data Byte									Second Data Byte												
MSB					LSB					MSB					LSB						
X	X	X	X	X	SW	SW	SW	A	SW	SW	SW	SW	SW	SW	SW	SW	SW	A	S		
					11	10	9	C	8	7	6	5	4	3	2	1	C	T			
								K									K	P			

**MAX4572**

First Data Byte									Second Data Byte												
MSB					LSB					MSB					LSB						
X	X	SW	SW	SW	SW	SW	SW	A	SW	SW	SW	SW	SW	SW	SW	SW	SW	A	S		
		8	5	7B	7A	6B	6A	C	4B	4A	3B	3A	2B	2A	1B	1A	C	T			
								K									K	P			

**MODESET Command**

Address Byte										Command Byte (MODESET)									
MSB					LSB					MSB				LSB					
S	0	1	1	0	1	A	A	0	A	0	1	X	X	X	X	X	X	A	S
R						1	0		C									C	T
T									K									K	P

**MAX4571**

First Data Byte									Second Data Byte												
MSB					LSB					MSB					LSB						
X	X	X	X	X	SW	SW	SW	A	SW	SW	SW	SW	SW	SW	SW	SW	SW	A	S		
					11	10	9	C	8	7	6	5	4	3	2	1	C	T			
								K									K	P			

**MAX4572**

First Data Byte									Second Data Byte												
MSB					LSB					MSB					LSB						
X	X	SW	SW	SW	SW	SW	SW	A	SW	SW	SW	SW	SW	SW	SW	SW	SW	A	S		
		8	5	7B	7A	6B	6A	C	4B	4A	3B	3A	2B	2A	1B	1A	C	T			
								K									K	P			

X = Don't Care  
 SRT = Start Condition  
 ACK = Acknowledge Condition

STP = Stop Condition  
 Logic "0" in any data bit location places the associated switch open or in soft (clickless) switching mode.  
 Logic "1" in any data bit location places the associated switch closed or in hard switching mode.  
 For command bit configuration see Table 1.

# Serially Controlled, Clickless Audio/Video Switches

MAX4571-MAX4574

**Table 4. 3-Wire Serial-Interface Data Format**

MAX4573 (11 SPST)															
MSB															LSB
COMMAND		SWITCH CONTROL													
D15	D14	D13	D12	D11	D10	D9	D8	D7	D6	D5	D4	D3	D2	D1	D0
C1	C0	X	X	X	SW11	SW10	SW9	SW8	SW7	SW6	SW5	SW4	SW3	SW2	SW1

MAX4574 (6 SPDT + 2 SPST)															
MSB															LSB
COMMAND		SWITCH CONTROL													
D15	D14	D13	D12	D11	D10	D9	D8	D7	D6	D5	D4	D3	D2	D1	D0
C1	C0	SW8	SW5	SW7B	SW7A	SW6B	SW6A	SW4B	SW4A	SW3B	SW3A	SW2B	SW2A	SW1B	SW1A

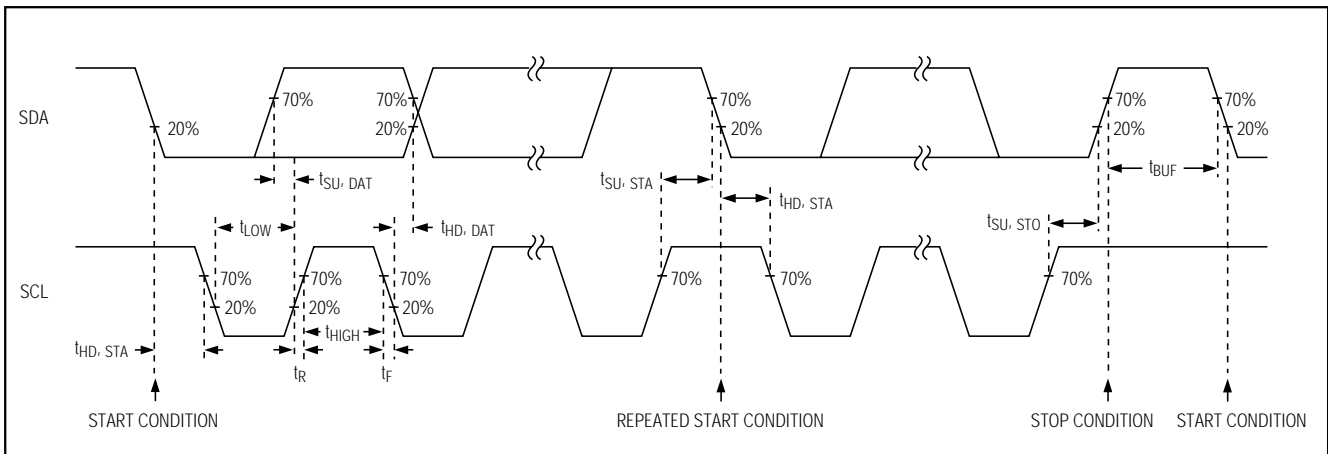

Figure 3. 2-Wire Serial-Interface Timing Diagram



Figure 4. A Complete 2-Wire Serial-Interface Transmission

# Serially Controlled, Clickless Audio/Video Switches

istors by connecting DOUT of the first device to DIN of the second, etc. Connect the  $\overline{CS}$  pins of all devices together. Data are shifted through the MAX4573/MAX4574s in series. When  $\overline{CS}$  is brought high, all devices are updated simultaneously. If any of the devices in the chain are to be left unchanged, use a NO\_OP command for that device, as shown in Table 1.

An alternate way of connecting multiple devices is to decode the  $\overline{CS}$  line. In this case the DOUT pin is not used and the DIN pins of all devices are connected together. Address decode logic individually controls the  $\overline{CS}$  line of each device. When a device is to be selected its  $\overline{CS}$  line is brought low, data are shifted in, and its  $\overline{CS}$  is then brought high to execute the command.



Figure 5. 3-Wire Serial-Interface Timing Diagram

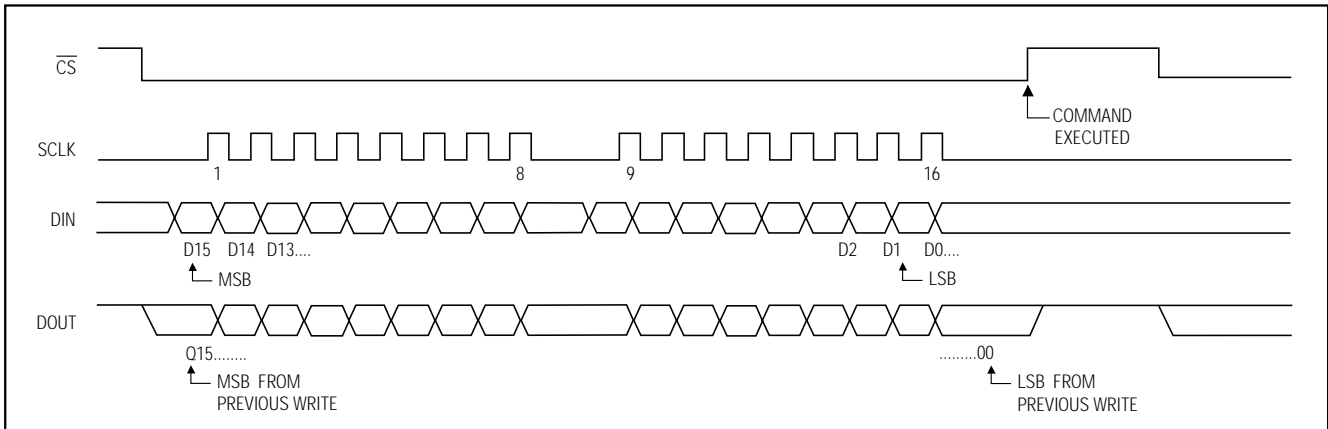

Figure 6. A Complete 3-Wire Serial-Interface Transmission

# Serially Controlled, Clickless Audio/Video Switches

## Pin Configurations (continued)

## Chip Information

TRANSISTOR COUNT: 5397

MAX4571-MAX4574



## Package Information



# Serially Controlled, Clickless Audio/Video Switches

## Package Information (continued)

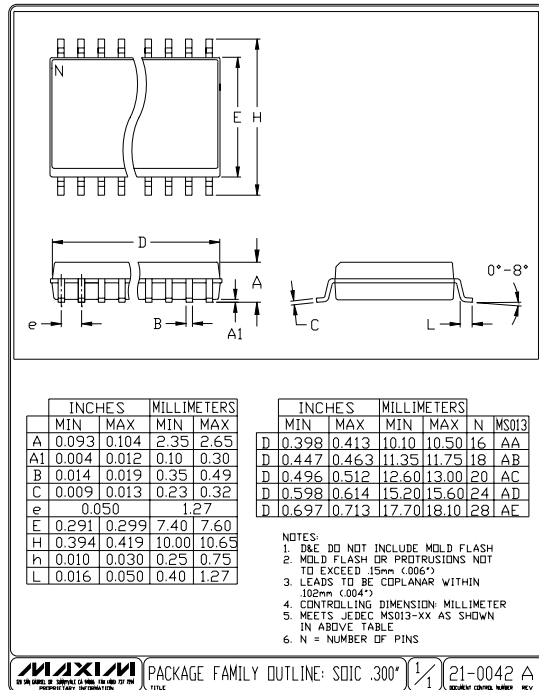
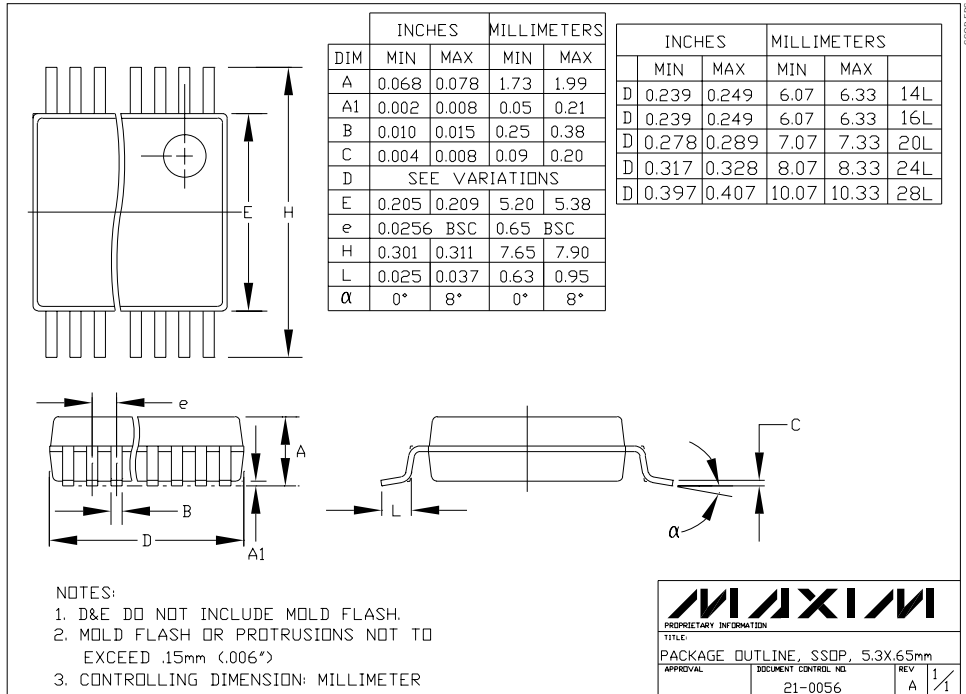

Maxim cannot assume responsibility for use of any circuitry other than circuitry entirely embodied in a Maxim product. No circuit patent licenses are implied. Maxim reserves the right to change the circuitry and specifications without notice at any time.

16 Maxim Integrated Products, 120 San Gabriel Drive, Sunnyvale, CA 94086 408-737-7600





**Стандарт  
Электрон  
Связь**

Мы молодая и активно развивающаяся компания в области поставок электронных компонентов. Мы поставляем электронные компоненты отечественного и импортного производства напрямую от производителей и с крупнейших складов мира.

Благодаря сотрудничеству с мировыми поставщиками мы осуществляем комплексные и плановые поставки широчайшего спектра электронных компонентов.

Собственная эффективная логистика и склад в обеспечивает надежную поставку продукции в точно указанные сроки по всей России.

Мы осуществляем техническую поддержку нашим клиентам и предпродажную проверку качества продукции. На все поставляемые продукты мы предоставляем гарантию .

Осуществляем поставки продукции под контролем ВП МО РФ на предприятия военно-промышленного комплекса России , а также работаем в рамках 275 ФЗ с открытием отдельных счетов в уполномоченном банке. Система менеджмента качества компании соответствует требованиям ГОСТ ISO 9001.

Минимальные сроки поставки, гибкие цены, неограниченный ассортимент и индивидуальный подход к клиентам являются основой для выстраивания долгосрочного и эффективного сотрудничества с предприятиями радиоэлектронной промышленности, предприятиями ВПК и научно-исследовательскими институтами России.

С нами вы становитесь еще успешнее!

**Наши контакты:**

**Телефон:** +7 812 627 14 35

**Электронная почта:** [sales@st-electron.ru](mailto:sales@st-electron.ru)

**Адрес:** 198099, Санкт-Петербург,  
Промышленная ул, дом № 19, литера Н,  
помещение 100-Н Офис 331