



BUL49D

HIGH VOLTAGE FAST-SWITCHING NPN POWER TRANSISTOR

- NPN TRANSISTOR
- HIGH VOLTAGE CAPABILITY
- LOW SPREAD OF DYNAMIC PARAMETERS
- MINIMUM LOT-TO-LOT SPREAD FOR RELIABLE OPERATION
- VERY HIGH SWITCHING SPEED
- HIGH RUGGEDNESS

APPLICATIONS

- ELECTRONIC TRANSFORMERS FOR HALOGEN LAMPS
- FLYBACK AND FORWARD SINGLE TRANSISTOR LOW POWER CONVERTERS

DESCRIPTION

The BUL49D is manufactured using high voltage Multi Epitaxial Planar technology for high switching speeds and medium voltage capability. The BUL49D is designed for use in electronic transformers for halogen lamps.

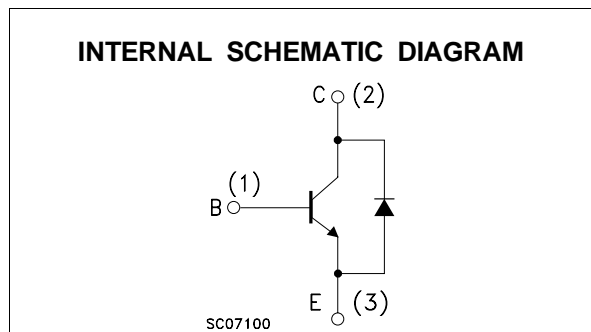

ABSOLUTE MAXIMUM RATINGS

Symbol	Parameter	Value	Unit
V_{CES}	Collector-Emitter Voltage ($V_{BE} = 0$)	850	V
V_{CEO}	Collector-Emitter Voltage ($I_B = 0$)	450	V
V_{EBO}	Emitter-Base Voltage ($I_C = 0$, $I_B < 2.5$ A, $t_p < 10\mu s$, $T_J < 150$ °C)	BV_{EBO}	V
I_C	Collector Current	5	A
I_{CM}	Collector Peak Current ($t_p < 5$ ms)	10	A
I_B	Base Current	2	A
I_{BM}	Base Peak Current ($t_p < 5$ ms)	4	A
P_{tot}	Total Dissipation at $T_c = 25$ °C	80	W
T_{stg}	Storage Temperature	-65 to 150	°C
T_J	Max. Operating Junction Temperature	150	°C

BUL49D

THERMAL DATA

R _{thj-case}	Thermal Resistance Junction-Case	Max	1.56	°C/W
R _{thj-amb}	Thermal Resistance Junction-Ambient	Max	62.5	°C/W

ELECTRICAL CHARACTERISTICS (T_{case} = 25 °C unless otherwise specified)

Symbol	Parameter	Test Conditions	Min.	Typ.	Max.	Unit
I _{CES}	Collector Cut-off Current (V _{BE} = 0)	V _{CE} = 850 V V _{CE} = 850 V T _j = 125 °C			100 500	μA μA
I _{EBO}	Emitter Cut-off Current (I _C = 0)	V _{EB} = 9 V			100	μA
BV _{EBO}	Emitter-Base Breakdown Voltage (I _C = 0)	I _E = 10mA	10		18	V
V _{CEO(sus)*}	Collector-Emitter Sustaining Voltage (I _B = 0)	I _C = 10 mA L = 25 mH	450			V
V _{CE(sat)*}	Collector-Emitter Saturation Voltage	I _C = 1 A I _B = 0.2 A I _C = 2 A I _B = 0.4 A I _C = 4 A I _B = 0.8 A		0.1	0.3 0.6 1.2	V V V
V _{BE(sat)*}	Base-Emitter Saturation Voltage	I _C = 1 A I _B = 0.2 A I _C = 4 A I _B = 0.8 A			1.0 1.3	V V
h _{FE*}	DC Current Gain	I _C = 10 mA V _{CE} = 5 V I _C = 0.5 A V _{CE} = 5 V I _C = 7 A V _{CE} = 10 V	10 4		60 10	
V _{CEW}	Maximum Collector Emitter Voltage Without Snubber	I _C = 8 A R _{BB} = 0 Ω V _{BB} = -2.5 V L = 50μH t _p = 10 μs	450			V
t _s t _f	RESISTIVE LOAD Storage Time Fall Time	I _C = 2 A V _{CC} = 250 V I _{B(on)} = I _{B(off)} = 0.4 A	2		3 0.8	μs μs
t _s t _f	INDUCTIVE LOAD Storage Time Fall Time	I _C = 4 A I _{B(on)} = 0.8 A V _{BE(off)} = -5 V R _{BB} = 0 Ω V _{CL} = 300 V L = 1 mH		0.6 50	1.3 100	μs ns
V _f	Diode Forward Voltage	I _C = 3 A			1.5	V

* Pulsed: Pulse duration = 300 μs, duty cycle 1.5 %

Safe Operating Areas

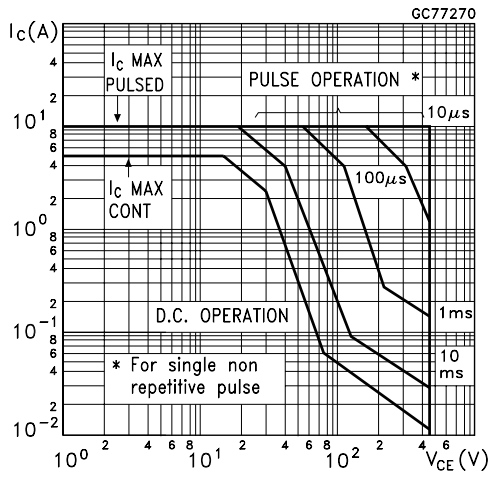

Derating Curve

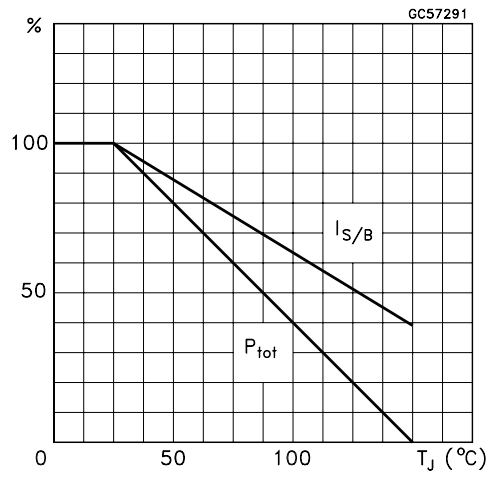

DC Current Gain

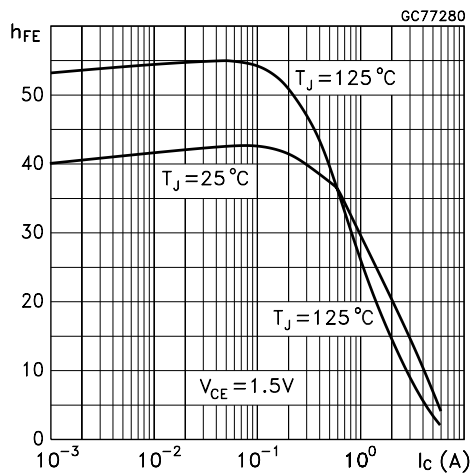

DC Current Gain

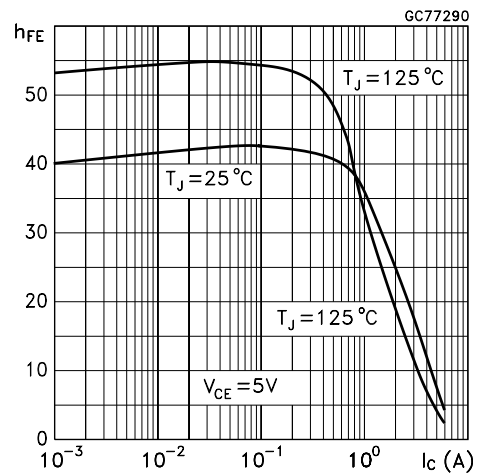

Collector Emitter Saturation Voltage

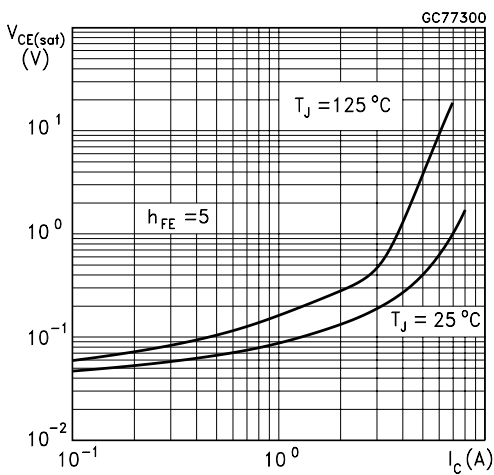

Base Emitter Saturation Voltage

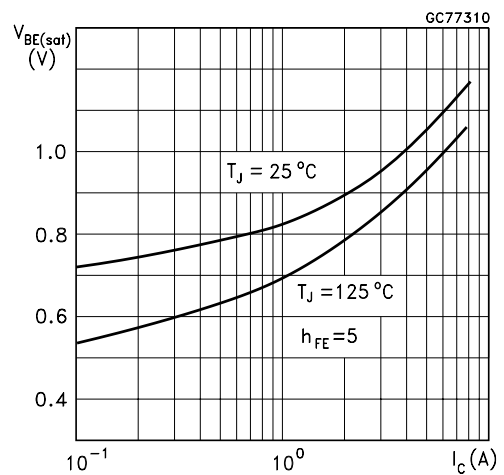

Inductive Fall Time

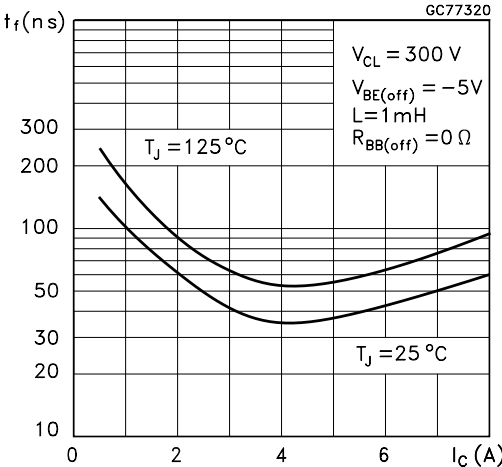

Inductive Storage Time

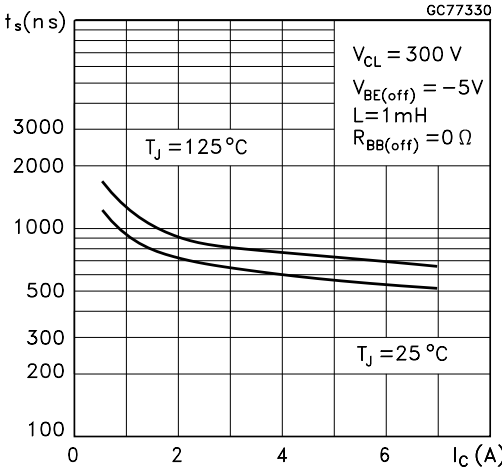

Reverse Biased SOA

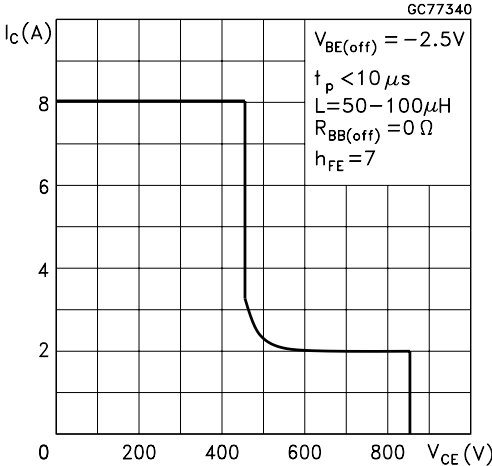

TO-220 MECHANICAL DATA

DIM.	mm			inch		
	MIN.	TYP.	MAX.	MIN.	TYP.	MAX.
A	4.40		4.60	0.173		0.181
C	1.23		1.32	0.048		0.052
D	2.40		2.72	0.094		0.107
E	0.49		0.70	0.019		0.027
F	0.61		0.88	0.024		0.034
F1	1.14		1.70	0.044		0.067
F2	1.14		1.70	0.044		0.067
G	4.95		5.15	0.194		0.202
G1	2.40		2.70	0.094		0.106
H2	10.00		10.40	0.394		0.409
L2		16.40			0.645	
L4	13.00		14.00	0.511		0.551
L5	2.65		2.95	0.104		0.116
L6	15.25		15.75	0.600		0.620
L7	6.20		6.60	0.244		0.260
L9	3.50		3.93	0.137		0.154
M		2.60			0.102	
DIA.	3.75		3.85	0.147		0.151



Information furnished is believed to be accurate and reliable. However, STMicroelectronics assumes no responsibility for the consequences of use of such information nor for any infringement of patents or other rights of third parties which may result from its use. No license is granted by implication or otherwise under any patent or patent rights of STMicroelectronics. Specification mentioned in this publication are subject to change without notice. This publication supersedes and replaces all information previously supplied. STMicroelectronics products are not authorized for use as critical components in life support devices or systems without express written approval of STMicroelectronics.

The ST logo is a trademark of STMicroelectronics

© 2001 STMicroelectronics – Printed in Italy – All Rights Reserved

STMicroelectronics GROUP OF COMPANIES

Australia - Brazil - China - Finland - France - Germany - Hong Kong - India - Italy - Japan - Malaysia - Malta - Morocco - Singapore - Spain - Sweden - Switzerland - United Kingdom - U.S.A.

<http://www.st.com>



Стандарт Электрон Связь

Мы молодая и активно развивающаяся компания в области поставок электронных компонентов. Мы поставляем электронные компоненты отечественного и импортного производства напрямую от производителей и с крупнейших складов мира.

Благодаря сотрудничеству с мировыми поставщиками мы осуществляем комплексные и плановые поставки широчайшего спектра электронных компонентов.

Собственная эффективная логистика и склад в обеспечивает надежную поставку продукции в точно указанные сроки по всей России.

Мы осуществляем техническую поддержку нашим клиентам и предпродажную проверку качества продукции. На все поставляемые продукты мы предоставляем гарантию .

Осуществляем поставки продукции под контролем ВП МО РФ на предприятия военно-промышленного комплекса России , а также работаем в рамках 275 ФЗ с открытием отдельных счетов в уполномоченном банке. Система менеджмента качества компании соответствует требованиям ГОСТ ISO 9001.

Минимальные сроки поставки, гибкие цены, неограниченный ассортимент и индивидуальный подход к клиентам являются основой для выстраивания долгосрочного и эффективного сотрудничества с предприятиями радиоэлектронной промышленности, предприятиями ВПК и научно-исследовательскими институтами России.

С нами вы становитесь еще успешнее!

Наши контакты:

Телефон: +7 812 627 14 35

Электронная почта: sales@st-electron.ru

Адрес: 198099, Санкт-Петербург,
Промышленная ул, дом № 19, литера Н,
помещение 100-Н Офис 331