

BC848 series

30 V, 100 mA NPN general-purpose transistors

Rev. 07 — 17 November 2009

Product data sheet

1. Product profile

1.1 General description

NPN general-purpose transistors in Surface Mounted Device (SMD) plastic packages.

Table 1. Product overview

Type number	Package			PNP complement
	NXP	JEITA	JEDEC	
BC848B	SOT23	-	TO-236AB	BC858B
BC848W	SOT323	SC-70	-	BC858W

1.2 Features

- General-purpose transistors
- SMD plastic packages

1.3 Applications

- General-purpose switching and amplification

1.4 Quick reference data

Table 2. Quick reference data

Symbol	Parameter	Conditions	Min	Typ	Max	Unit
V_{CE0}	collector-emitter voltage	open base	-	-	30	V
I_C	collector current		-	-	100	mA
h_{FE}	DC current gain	$V_{CE} = 5\text{ V};$ $I_C = 2\text{ mA}$				
	BC848B		200	290	450	
	BC848W		110	-	800	

2. Pinning information

Table 3. Pinning

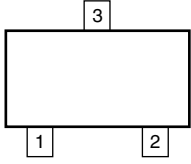
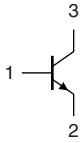
Pin	Description	Simplified outline	Symbol
1	base	 <p>006aaa144</p>	 <p>sym021</p>
2	emitter		
3	collector		

3. Ordering information

Table 4. Ordering information

Type number	Package		
	Name	Description	Version
BC848B	-	plastic surface mounted package; 3 leads	SOT23
BC848W	SC-70	plastic surface mounted package; 3 leads	SOT323

4. Marking

Table 5. Marking codes

Type number	Marking code ^[1]
BC848B	1K*
BC848W	1M*

- [1] * = -: made in Hong Kong
 * = p: made in Hong Kong
 * = t: made in Malaysia
 * = W: made in China

5. Limiting values

Table 6. Limiting values

In accordance with the Absolute Maximum Rating System (IEC 60134).

Symbol	Parameter	Conditions	Min	Max	Unit
V_{CBO}	collector-base voltage	open emitter	-	30	V
V_{CEO}	collector-emitter voltage	open base	-	30	V
V_{EBO}	emitter-base voltage	open collector	-	5	V
I_C	collector current		-	100	mA
I_{CM}	peak collector current	single pulse; $t_p \leq 1$ ms	-	200	mA
I_{BM}	peak base current	single pulse; $t_p \leq 1$ ms	-	200	mA
P_{tot}	total power dissipation	$T_{amb} \leq 25$ °C	[1]		
	SOT23		-	250	mW
	SOT323		-	200	mW
T_j	junction temperature		-	150	°C
T_{amb}	ambient temperature		-65	+150	°C
T_{stg}	storage temperature		-65	+150	°C

[1] Device mounted on an FR4 Printed-Circuit Board (PCB), single-sided copper, tin-plated and standard footprint.

6. Thermal characteristics

Table 7. Thermal characteristics

Symbol	Parameter	Conditions	Min	Typ	Max	Unit
$R_{th(j-a)}$	thermal resistance from junction to ambient	in free air	[1]			
	SOT23		-	-	500	K/W
	SOT323		-	-	625	K/W

[1] Device mounted on an FR4 PCB, single-sided copper, tin-plated and standard footprint.

7. Characteristics

Table 8. Characteristics
 $T_{amb} = 25\text{ }^{\circ}\text{C}$ unless otherwise specified.

Symbol	Parameter	Conditions	Min	Typ	Max	Unit	
I_{CBO}	collector-base cut-off current	$V_{CB} = 30\text{ V}; I_E = 0\text{ A}$	-	-	15	nA	
		$V_{CB} = 30\text{ V}; I_E = 0\text{ A}; T_j = 150\text{ }^{\circ}\text{C}$	-	-	5	μA	
I_{EBO}	emitter-base cut-off current	$V_{EB} = 5\text{ V}; I_E = 0\text{ A}$	-	-	100	nA	
h_{FE}	DC current gain	$V_{CE} = 5\text{ V}; I_C = 10\text{ }\mu\text{A}$	-	150	-		
		$V_{CE} = 5\text{ V}; I_C = 2\text{ mA}$					
		BC848B	200	290	450		
		BC848W	110	-	800		
V_{CEsat}	collector-emitter saturation voltage	$I_C = 10\text{ mA}; I_B = 0.5\text{ mA}$	-	90	250	mV	
		$I_C = 100\text{ mA}; I_B = 5\text{ mA}$	[1]	-	200	600	mV
V_{BEsat}	base-emitter saturation voltage	$I_C = 10\text{ mA}; I_B = 0.5\text{ mA}$	[2]	-	700	-	mV
		$I_C = 100\text{ mA}; I_B = 5\text{ mA}$	[2]	-	900	-	mV
V_{BE}	base-emitter voltage	$I_C = 2\text{ mA}; V_{CE} = 5\text{ V}$	[3]	580	660	700	mV
		$I_C = 10\text{ mA}; V_{CE} = 5\text{ V}$	[3]	-	-	770	mV
f_T	transition frequency	$V_{CE} = 5\text{ V}; I_C = 10\text{ mA}; f = 100\text{ MHz}$	100	-	-	MHz	
C_C	collector capacitance	$V_{CB} = 10\text{ V}; I_E = i_e = 0\text{ A}; f = 1\text{ MHz}$	-	2.5	3	pF	
NF	noise figure	$V_{CE} = 5\text{ V}; I_C = 200\text{ }\mu\text{A}; R_S = 2\text{ k}\Omega; f = 1\text{ kHz}; B = 200\text{ Hz}$	-	2	10	dB	

[1] Pulse test: $t_p \leq 300\text{ }\mu\text{s}; \delta \leq 0.02$.

[2] V_{BEsat} decreases by approximately 1.7 mV/K with increasing temperature.

[3] V_{BE} decreases by approximately 2 mV/K with increasing temperature.

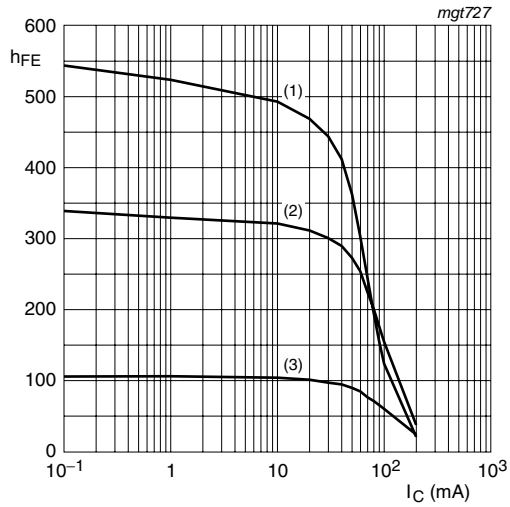

$V_{CE} = 5\text{ V}$
 (1) $T_{amb} = 150\text{ }^{\circ}\text{C}$
 (2) $T_{amb} = 25\text{ }^{\circ}\text{C}$
 (3) $T_{amb} = -55\text{ }^{\circ}\text{C}$

Fig 1. BC848B: DC current gain as a function of collector current; typical values

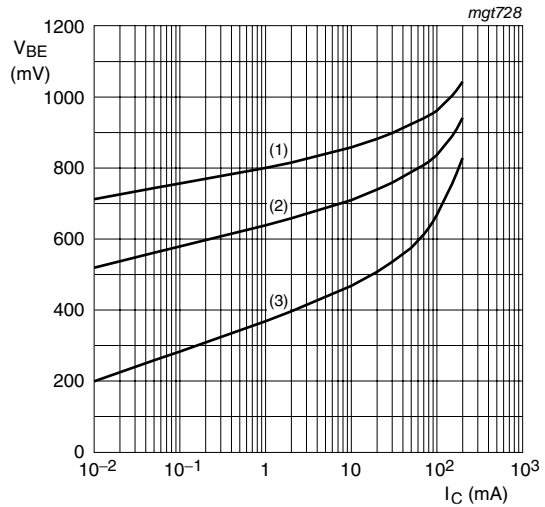

$V_{CE} = 5\text{ V}$
 (1) $T_{amb} = -55\text{ }^{\circ}\text{C}$
 (2) $T_{amb} = 25\text{ }^{\circ}\text{C}$
 (3) $T_{amb} = 150\text{ }^{\circ}\text{C}$

Fig 2. BC848B: Base-emitter voltage as a function of collector current; typical values

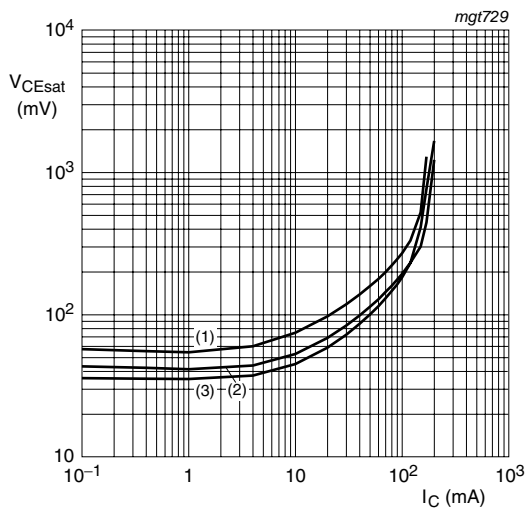

$I_C/I_B = 20$
 (1) $T_{amb} = 150\text{ }^{\circ}\text{C}$
 (2) $T_{amb} = 25\text{ }^{\circ}\text{C}$
 (3) $T_{amb} = -55\text{ }^{\circ}\text{C}$

Fig 3. BC848B: Collector-emitter saturation voltage as a function of collector current; typical values

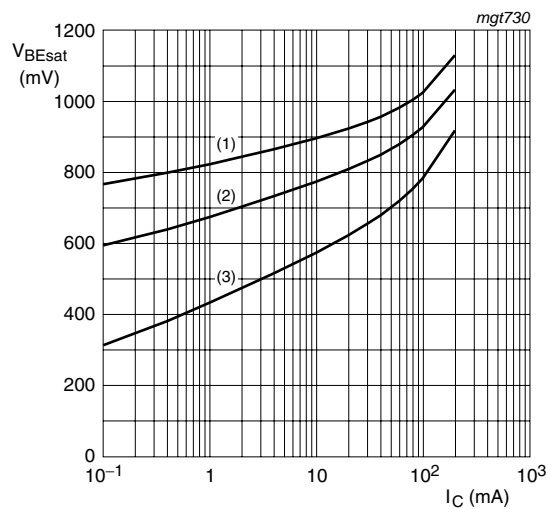

$I_C/I_B = 10$
 (1) $T_{amb} = -55\text{ }^{\circ}\text{C}$
 (2) $T_{amb} = 25\text{ }^{\circ}\text{C}$
 (3) $T_{amb} = 150\text{ }^{\circ}\text{C}$

Fig 4. BC848B: Base-emitter saturation voltage as a function of collector current; typical values

8. Package outline

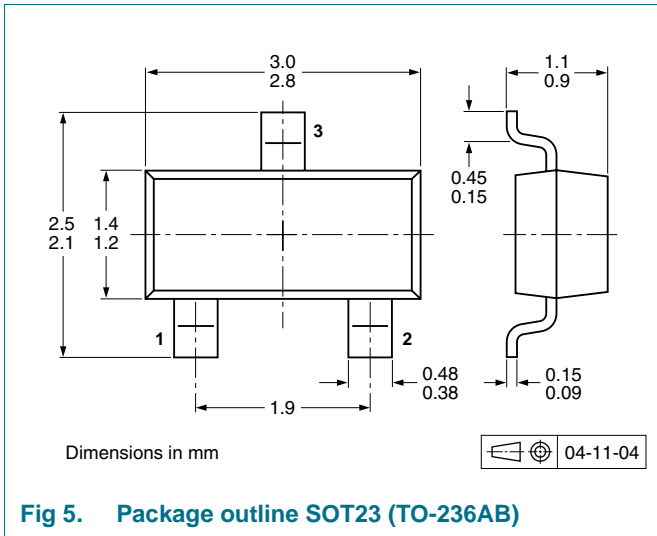

Fig 5. Package outline SOT23 (TO-236AB)

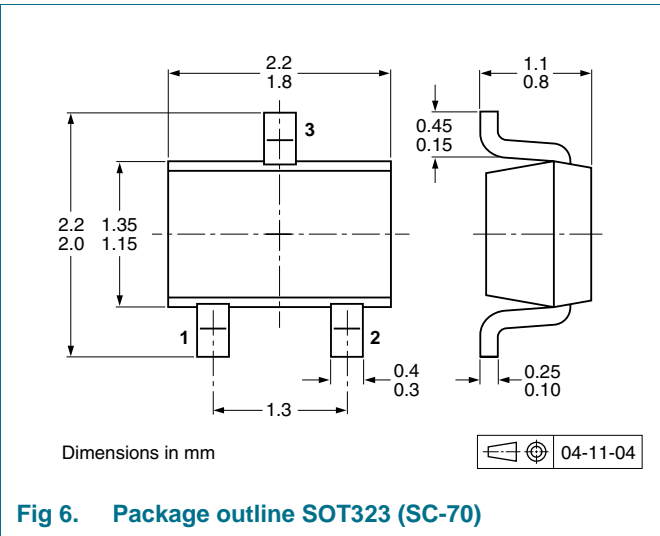

Fig 6. Package outline SOT323 (SC-70)

9. Packing information

Table 9. Packing methods

The indicated -xxx are the last three digits of the 12NC ordering code.^[1]

Type number	Package	Description	Packing quantity	
			3000	10000
BC848B	SOT23	4 mm pitch, 8 mm tape and reel	-215	-235
BC848W	SOT323	4 mm pitch, 8 mm tape and reel	-115	-135

[1] For further information and the availability of packing methods, see [Section 14](#).

10. Soldering

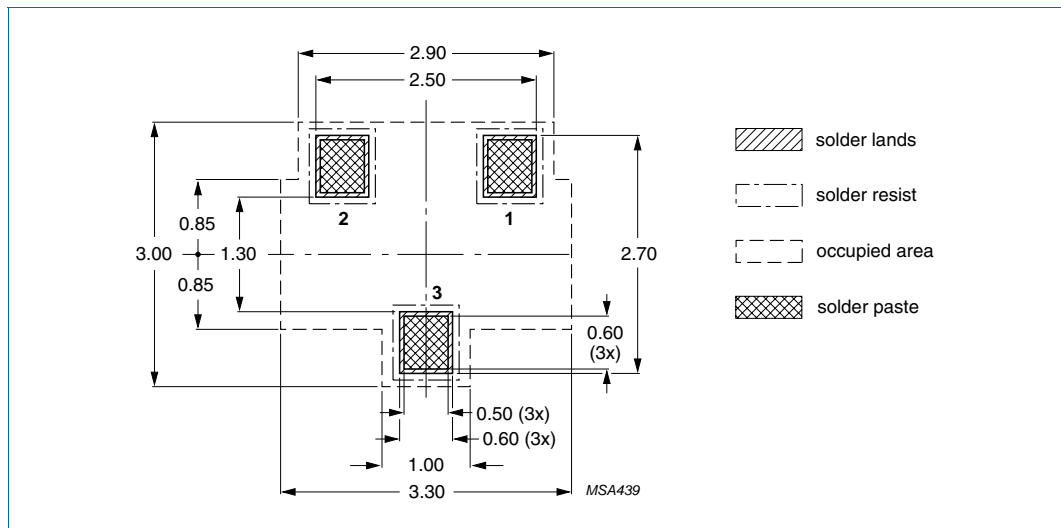

Dimensions in mm

Fig 7. Reflow soldering footprint SOT23 (TO-236AB)

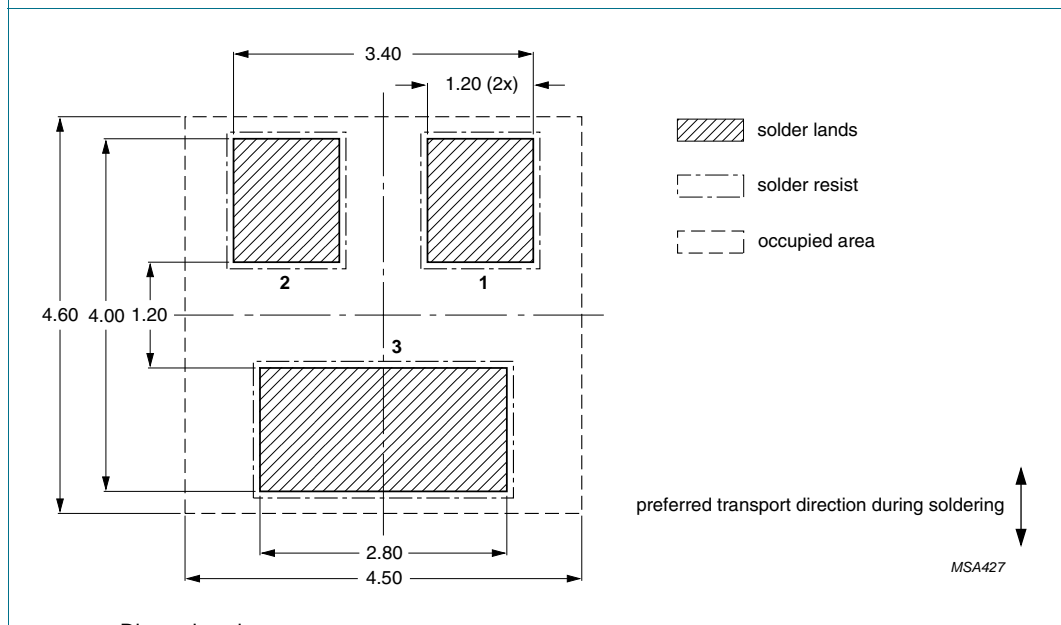

Dimensions in mm

Fig 8. Wave soldering footprint SOT23 (TO-236AB)

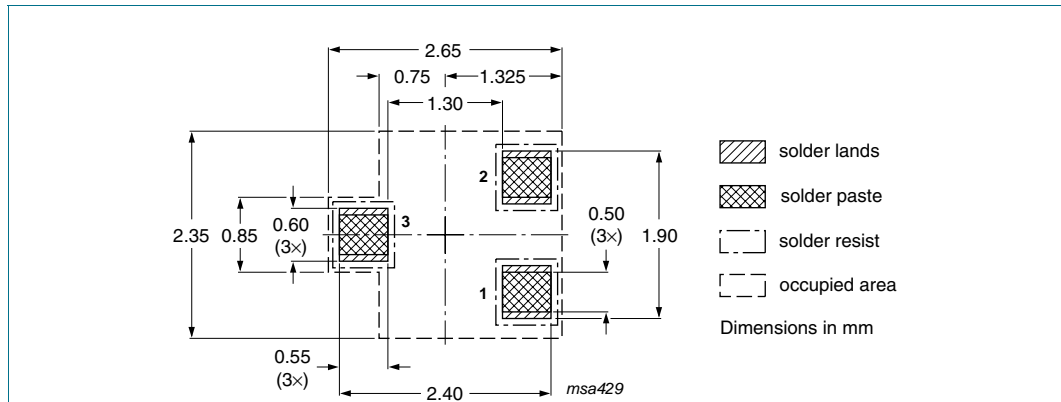

Fig 9. Reflow soldering footprint SOT323 (SC-70)

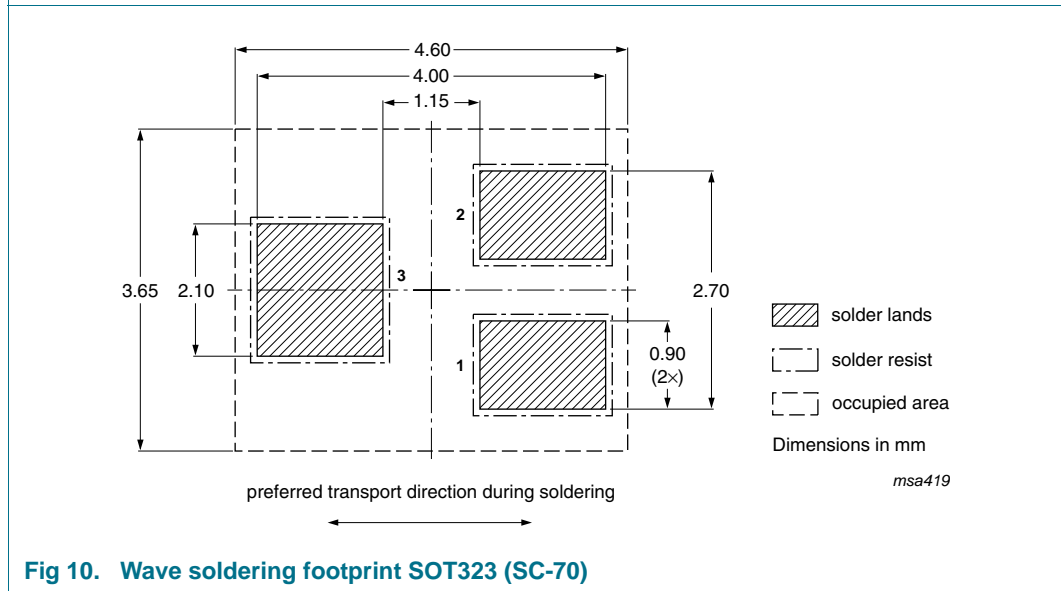
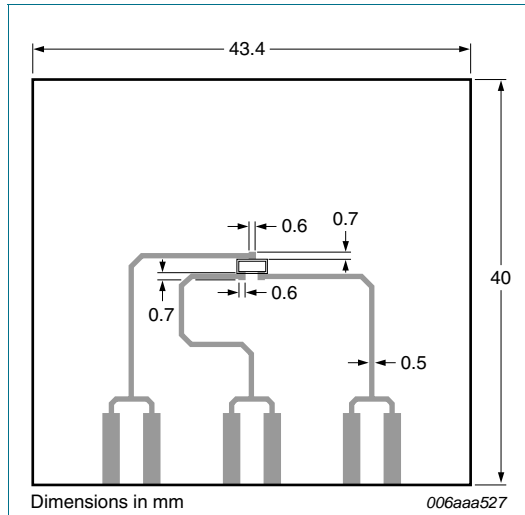

Fig 10. Wave soldering footprint SOT323 (SC-70)

11. Mounting



PCB thickness:
FR4 PCB = 1.6 mm

Fig 11. FR4 PCB, standard footprint SOT23 (TO-236AB)

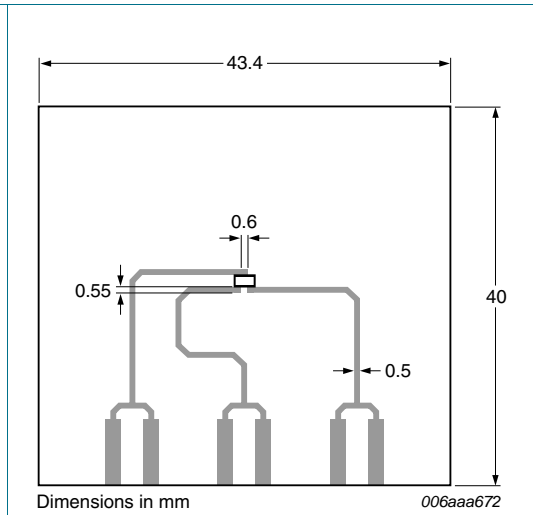

PCB thickness:
FR4 PCB = 1.6 mm

Fig 12. FR4 PCB, standard footprint SOT323 (SC-70)

12. Revision history

Table 10. Revision history

Document ID	Release date	Data sheet status	Change notice	Supersedes
BC848_SER_7	20091117	Product data sheet	-	BC848_SER_6
Modifications:	<ul style="list-style-type: none"> • This data sheet was changed to reflect the new company name NXP Semiconductors, including new legal definitions and disclaimers. No changes were made to the technical content. • Figure 9 “Reflow soldering footprint SOT323 (SC-70)”: updated • Figure 10 “Wave soldering footprint SOT323 (SC-70)”: updated 			
BC848_SER_6	20060203	Product data sheet	-	BC846_BC847_ BC848_5 BC846W_BC847W_ BC848W_4
BC846_BC847_BC848_5	20040206	Product specification	-	BC846_BC847_ BC848_4
BC846W_BC847W_ BC848W_4	20020204	Product specification	-	BC846W_847W_3

13. Legal information

13.1 Data sheet status

Document status ^{[1][2]}	Product status ^[3]	Definition
Objective [short] data sheet	Development	This document contains data from the objective specification for product development.
Preliminary [short] data sheet	Qualification	This document contains data from the preliminary specification.
Product [short] data sheet	Production	This document contains the product specification.

[1] Please consult the most recently issued document before initiating or completing a design.

[2] The term 'short data sheet' is explained in section "Definitions".

[3] The product status of device(s) described in this document may have changed since this document was published and may differ in case of multiple devices. The latest product status information is available on the Internet at URL <http://www.nxp.com>.

13.2 Definitions

Draft — The document is a draft version only. The content is still under internal review and subject to formal approval, which may result in modifications or additions. NXP Semiconductors does not give any representations or warranties as to the accuracy or completeness of information included herein and shall have no liability for the consequences of use of such information.

Short data sheet — A short data sheet is an extract from a full data sheet with the same product type number(s) and title. A short data sheet is intended for quick reference only and should not be relied upon to contain detailed and full information. For detailed and full information see the relevant full data sheet, which is available on request via the local NXP Semiconductors sales office. In case of any inconsistency or conflict with the short data sheet, the full data sheet shall prevail.

13.3 Disclaimers

General — Information in this document is believed to be accurate and reliable. However, NXP Semiconductors does not give any representations or warranties, expressed or implied, as to the accuracy or completeness of such information and shall have no liability for the consequences of use of such information.

Right to make changes — NXP Semiconductors reserves the right to make changes to information published in this document, including without limitation specifications and product descriptions, at any time and without notice. This document supersedes and replaces all information supplied prior to the publication hereof.

Suitability for use — NXP Semiconductors products are not designed, authorized or warranted to be suitable for use in medical, military, aircraft, space or life support equipment, nor in applications where failure or malfunction of an NXP Semiconductors product can reasonably be expected to result in personal injury, death or severe property or environmental

damage. NXP Semiconductors accepts no liability for inclusion and/or use of NXP Semiconductors products in such equipment or applications and therefore such inclusion and/or use is at the customer's own risk.

Applications — Applications that are described herein for any of these products are for illustrative purposes only. NXP Semiconductors makes no representation or warranty that such applications will be suitable for the specified use without further testing or modification.

Limiting values — Stress above one or more limiting values (as defined in the Absolute Maximum Ratings System of IEC 60134) may cause permanent damage to the device. Limiting values are stress ratings only and operation of the device at these or any other conditions above those given in the Characteristics sections of this document is not implied. Exposure to limiting values for extended periods may affect device reliability.

Terms and conditions of sale — NXP Semiconductors products are sold subject to the general terms and conditions of commercial sale, as published at <http://www.nxp.com/profile/terms>, including those pertaining to warranty, intellectual property rights infringement and limitation of liability, unless explicitly otherwise agreed to in writing by NXP Semiconductors. In case of any inconsistency or conflict between information in this document and such terms and conditions, the latter will prevail.

No offer to sell or license — Nothing in this document may be interpreted or construed as an offer to sell products that is open for acceptance or the grant, conveyance or implication of any license under any copyrights, patents or other industrial or intellectual property rights.

Export control — This document as well as the item(s) described herein may be subject to export control regulations. Export might require a prior authorization from national authorities.

Quick reference data — The Quick reference data is an extract of the product data given in the Limiting values and Characteristics sections of this document, and as such is not complete, exhaustive or legally binding.

13.4 Trademarks

Notice: All referenced brands, product names, service names and trademarks are the property of their respective owners.

14. Contact information

For more information, please visit: <http://www.nxp.com>

For sales office addresses, please send an email to: salesaddresses@nxp.com

15. Contents

1 Product profile 1

1.1 General description 1

1.2 Features 1

1.3 Applications 1

1.4 Quick reference data 1

2 Pinning information 2

3 Ordering information 2

4 Marking 2

5 Limiting values 3

6 Thermal characteristics 3

7 Characteristics 4

8 Package outline 6

9 Packing information 6

10 Soldering 7

11 Mounting 9

12 Revision history 10

13 Legal information 11

13.1 Data sheet status 11

13.2 Definitions 11

13.3 Disclaimers 11

13.4 Trademarks 11

14 Contact information 11

15 Contents 12

Please be aware that important notices concerning this document and the product(s) described herein, have been included in section 'Legal information'.



© NXP B.V. 2009.

All rights reserved.

For more information, please visit: <http://www.nxp.com>

For sales office addresses, please send an email to: salesaddresses@nxp.com

Date of release: 17 November 2009

Document identifier: BC848_SER_7



Стандарт Электрон Связь

Мы молодая и активно развивающаяся компания в области поставок электронных компонентов. Мы поставляем электронные компоненты отечественного и импортного производства напрямую от производителей и с крупнейших складов мира.

Благодаря сотрудничеству с мировыми поставщиками мы осуществляем комплексные и плановые поставки широчайшего спектра электронных компонентов.

Собственная эффективная логистика и склад в обеспечивает надежную поставку продукции в точно указанные сроки по всей России.

Мы осуществляем техническую поддержку нашим клиентам и предпродажную проверку качества продукции. На все поставляемые продукты мы предоставляем гарантию .

Осуществляем поставки продукции под контролем ВП МО РФ на предприятия военно-промышленного комплекса России , а также работаем в рамках 275 ФЗ с открытием отдельных счетов в уполномоченном банке. Система менеджмента качества компании соответствует требованиям ГОСТ ISO 9001.

Минимальные сроки поставки, гибкие цены, неограниченный ассортимент и индивидуальный подход к клиентам являются основой для выстраивания долгосрочного и эффективного сотрудничества с предприятиями радиоэлектронной промышленности, предприятиями ВПК и научно-исследовательскими институтами России.

С нами вы становитесь еще успешнее!

Наши контакты:

Телефон: +7 812 627 14 35

Электронная почта: sales@st-electron.ru

Адрес: 198099, Санкт-Петербург,
Промышленная ул, дом № 19, литера Н,
помещение 100-Н Офис 331