

■ ABSOLUTE MAXIMUM RANGE

(Ta=25°C)

PARAMETER	SYMBOL	RATINGS	UNIT
Supply Voltage	V ⁺	+7	V
Power Dissipation	P _D	(DIP8) 500 (DMP8) 500 (note1) (SSOP8) 360 (note1) (VSP8/TVSP8) 320	mW
Operating Temperature Range	Topr	-40 to +85	°C
Storage Temperature Range	Tstg	-40 to +125	°C

(note1) Mounted on PC Board

■ ELECTRICAL CHARACTERISTICS

 (V⁺=6.0V, 1pin=2V, Ta=25°C unless otherwise specified)

PARAMETER	SYMBOL	TEST CONDITIONS	MIN.	TYP.	MAX.	UNIT
Operating Voltage	V ⁺		2.0	-	6.0	V
Operating Current	I _{CC}	V ⁺ =3.0V, R _L =∞, No Signal	-	2.2	3.5	mA
Operating Current at Power Down Mode	I _{CCD}	V ⁺ =3.0V, R _L =∞, 1pin=0.8V, No Signal	-	0.1	1.0	μA
Open Loop Gain	A _{V1}	Amp#A, f<100Hz	84	90	-	dB
Closed Loop Gain	A _{V2}	Amp#B, f=1kHz, R _L =32Ω	-0.35	0	+0.35	dB
Output Power	P _{O1}	V ⁺ =3.0V, R _L =16Ω, THD≤10% (note2)	55	-	-	mW
	P _{O2}	V ⁺ =6.0V, R _L =32Ω, THD≤10% (note2)	250	-	-	mW
Total Harmonic Distortion	THD1	V ⁺ =6V, R _L =32Ω, P _O =125mW, f=1kHz, G _{VD} =34dB	-	0.5	1.0	%
	THD2	V ⁺ ≥3V, R _L =8Ω, P _O =20mW, f=1kHz, G _{VD} =12dB	-	0.5	-	%
Power Supply Rejection Ratio (V ⁺ =3.0V-6.0V)	SVR1	C1=∞, C2=0.01μF, DC	50	-	-	dB
	SVR2	C1=0.1μF, C2=0, f=1kHz	-	12	-	dB
	SVR3	C1=1.0μF, C2=5.0μF, f=1kHz	-	47	-	dB
Mute Attenuation	MAT	f=1kHz-20kHz, 1pin=0.8V	-	70	-	dB
Output Voltage (R _f =75kΩ, DC)	V _{O1}	V ⁺ =3.0V, R _L =16Ω	1.00	1.15	1.25	V
	V _{O2}	V ⁺ =6.0V	-	2.60	-	V
Output High Level	V _{OH}	I _{OUT} =-75mA, V ⁺ =2.0-6.0V	-	V ⁺ -1.1	-	V
Output Low Level	V _{OL}	I _{OUT} =75mA, V ⁺ =2.0-6.0V	-30	0.21	-	V
Output DC Offset	ΔV _O	R _f =75kΩ, R _L =32Ω, 5pin-8pin	-30	0	+30	mV
Input Bias Current	I _B	4pin	-	0	-200	nA
Equivalent Resistance	R _{+IN}	3pin	100	170	220	kΩ
	R _{REF}	2pin	18	26	40	kΩ
CD Input Voltage H	V _{CDH}	1pin	2.0	-	V ⁺	V
CD Input Voltage L	V _{CDL}	1pin	0.0	-	0.8	V
CD Input Resistance	R _{CD}	V ⁺ =V _{CD} =6.0V, 1pin	50	85	175	kΩ

(note2) NJM2149M, NJM2149V, NJM2149R, NJM2149RB1: Mounted on PC Board

■ CONTROL TERMINAL EXPLANATION

CHIP DISABLE CONTROL (CD PIN)

PARAMETER	CONTROL SIGNAL	STATUS
CD OFF	H(=V _{CDH})	IC is active.
CD ON	L(=V _{CDL})	IC is standby. (with Mute)

APPLICATION CURCUIT

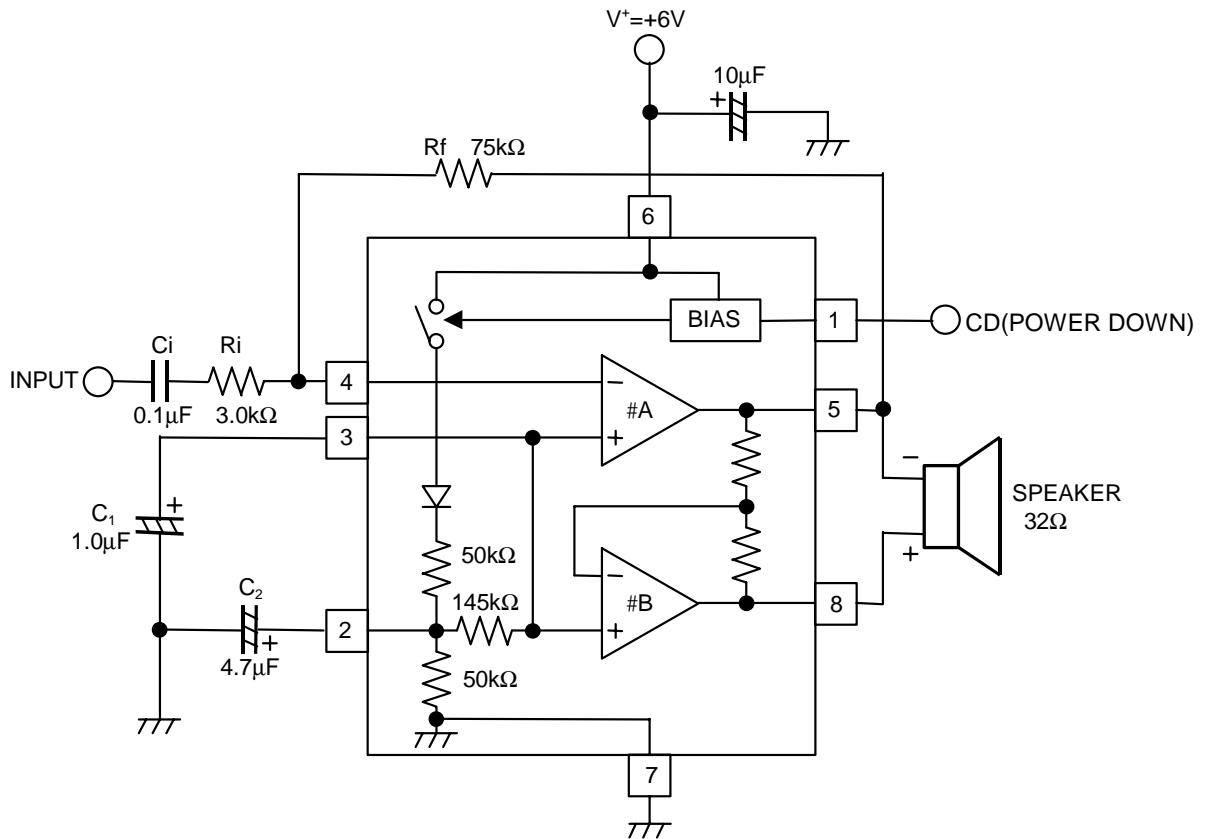

- note:1.The CD terminal(1pin) should connect High level(>2.0V), when NJM2149 is active.
The standby mode, when the CD terminal is Low level(<0.8V).
- 2.To add the C1 and C2 capacitor, the power-supply-rejection-ratio will be improved.
When C1 is large value, C2 will be unnecessary.
- 3.The power-up time depend on the C1 and C2 capacitor.
- 4.The input current of CD terminal is as shown below figure.

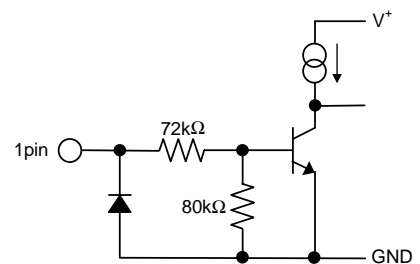

- 5.No connect oscillation-protect RC required.
To connect oscillation-protect RC, if the NJM2149 oscillate with PC board/stray capacitor/long speaker wire and others condition.

■ TYPICAL CHARACTERISTICS

Operating Current vs. Operating Voltage
($V_{CD}=V^+$, $T_a=25^\circ\text{C}$)

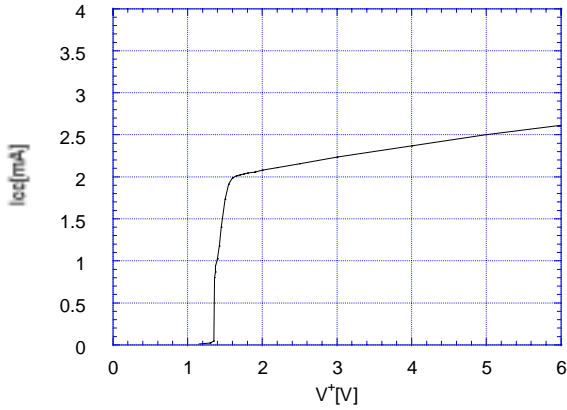

Standby Current vs. Operating Voltage
($V_{CD}=\text{GND}$, $T_a=25^\circ\text{C}$)

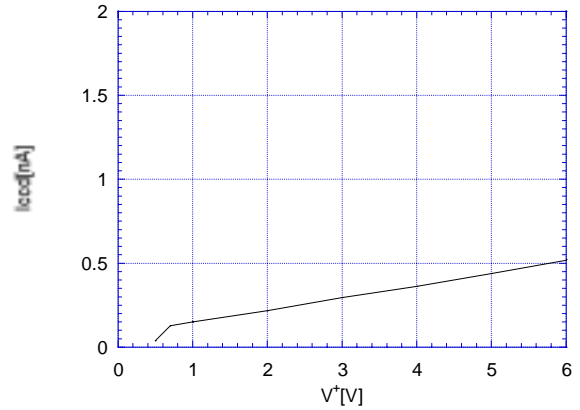

CD Sink Current vs. CD Voltage
($V^+=6\text{V}$, $T_a=25^\circ\text{C}$)

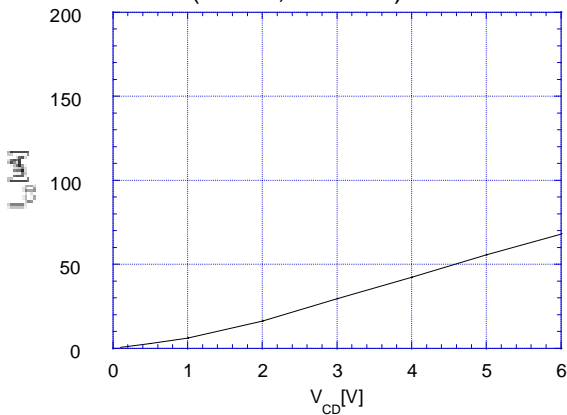

Power Dissipation vs. Output Power
($R_L=8\Omega$, $T_a=25^\circ\text{C}$)

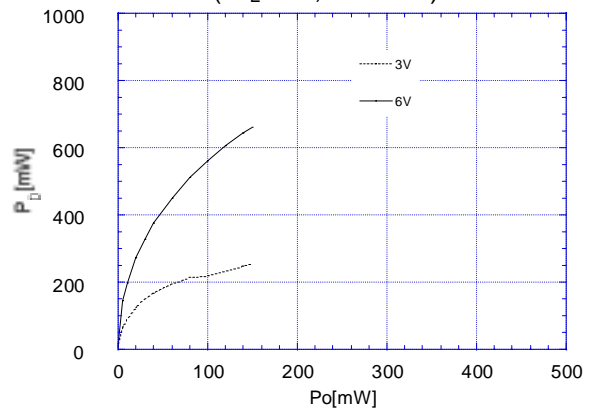

Power Dissipation vs. Output Power
($R_L=16\Omega$, $T_a=25^\circ\text{C}$)

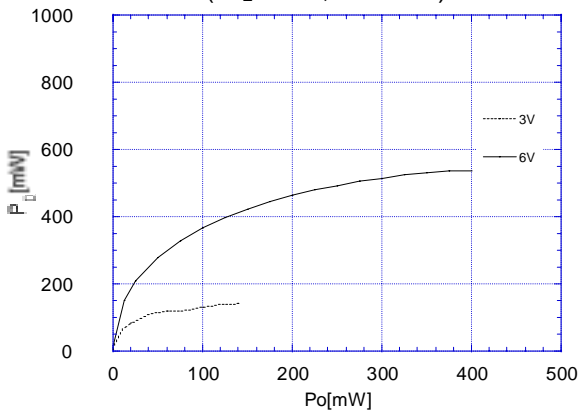

Power Dissipation vs. Output Power
($R_L=32\Omega$, $T_a=25^\circ\text{C}$)

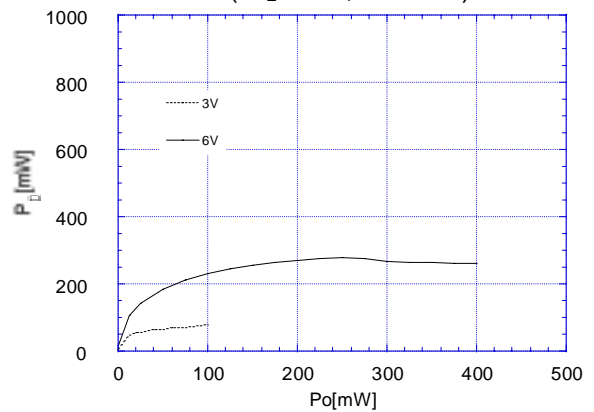

TYPICAL CHARACTERISTICS

Total Harmonic Distortion vs. Output Power
($f=1\text{kHz}$, $G_{VD}=34\text{dB}$, $T_a=25^\circ\text{C}$)

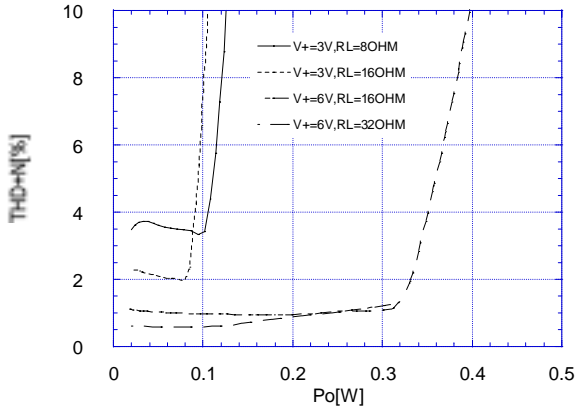

Total Harmonic Distortion vs. Output Power
($f=3\text{kHz}$, $G_{VD}=34\text{dB}$, $T_a=25^\circ\text{C}$)

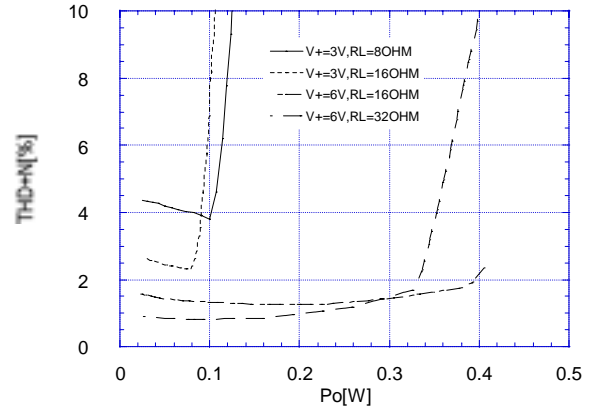

Total Harmonic Distortion vs. Output Power
($f=1.3\text{kHz}$, $G_{VD}=12\text{dB}$, $T_a=25^\circ\text{C}$)

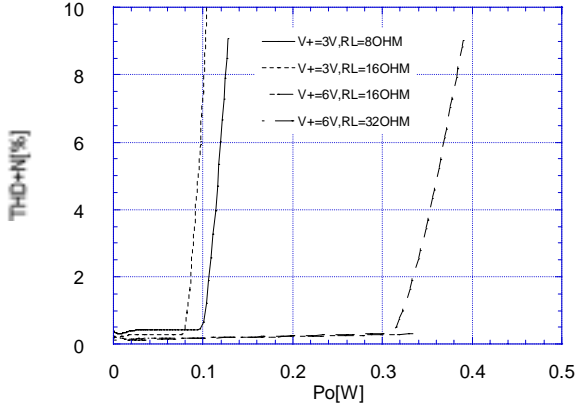

Maximum Output Swing vs. Load Current
(V^+ Side, $V^+=6\text{V}$, $T_a=25^\circ\text{C}$)

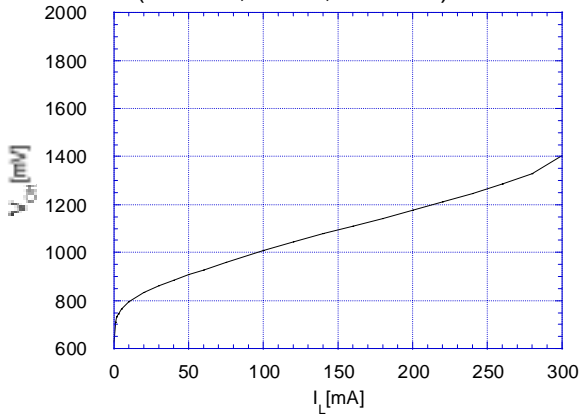

Maximum Output Swing vs. Load Current
(GND Side, $V^+=6\text{V}$, $T_a=25^\circ\text{C}$)

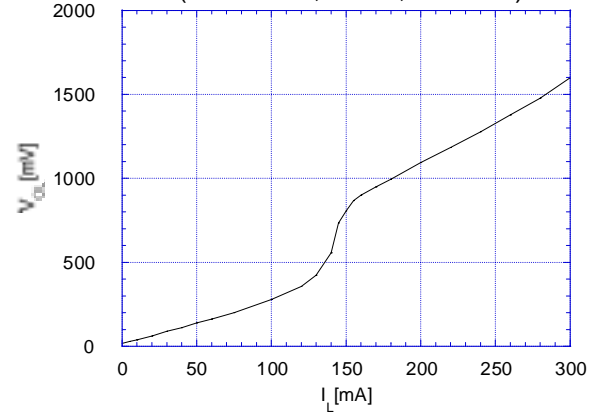

■ TYPICAL CHARACTERISTICS

Supply Voltage Rejection Ratio vs. Frequency
($V^+=6V, G_{VD}=34dB, C_2=0\mu F, T_a=25^\circ C$)

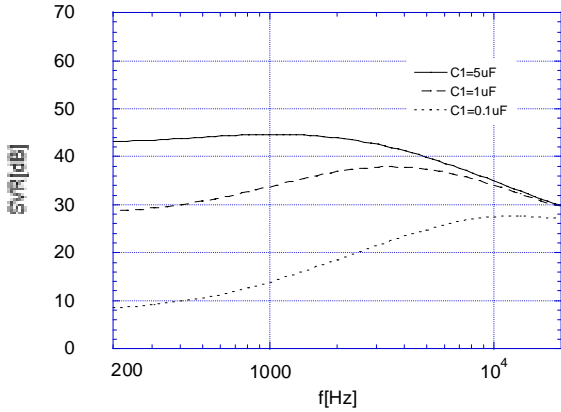

Supply Voltage Rejection Ratio vs. Frequency
($V^+=6V, G_{VD}=34dB, C_2=1\mu F, T_a=25^\circ C$)

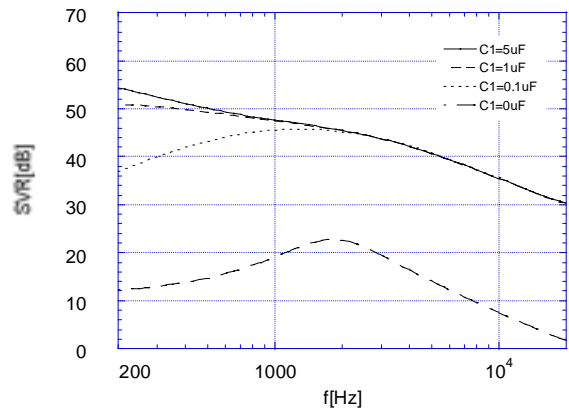

Supply Voltage Rejection Ratio vs. Frequency
($V^+=6V, G_{VD}=34dB, C_2=5\mu F, T_a=25^\circ C$)

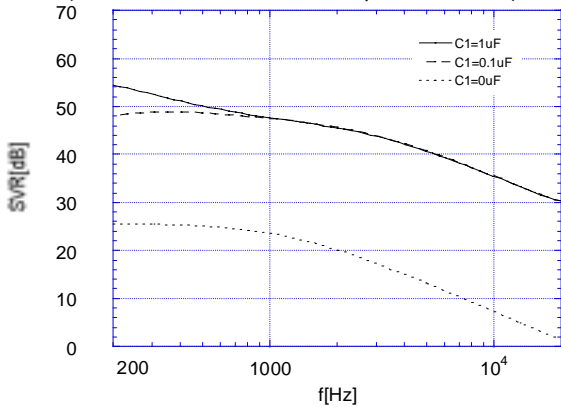

Supply Voltage Rejection Ratio vs. Frequency
($V^+=6V, G_{VD}=34dB, C_2=10\mu F, T_a=25^\circ C$)

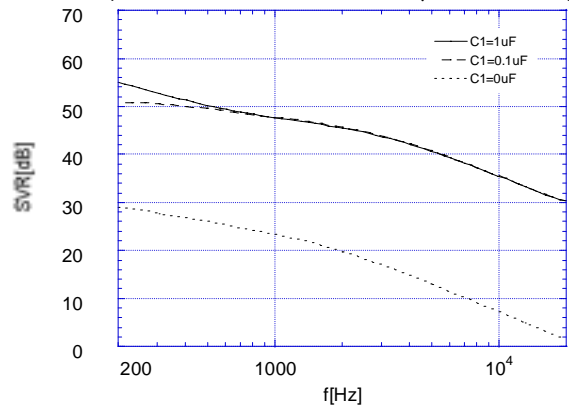

Operating Current vs. Temperature
($V^+=6V$)

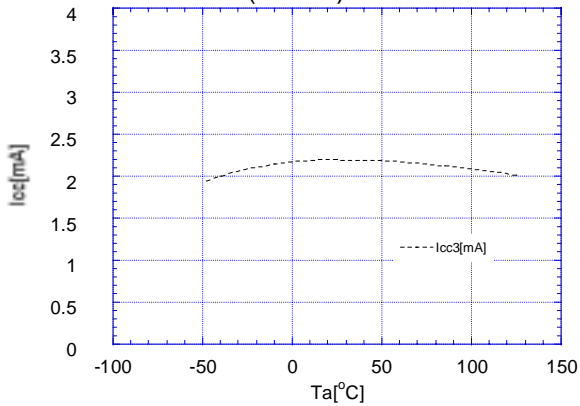

Standby Current vs. Temperature
($V^+=6V$)

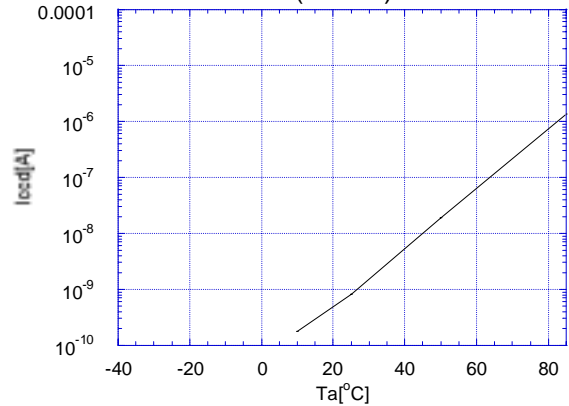

■ TYPICAL CHARACTERISTICS

Output Offset Voltage vs. Temperature
($V^+ = 6V$)

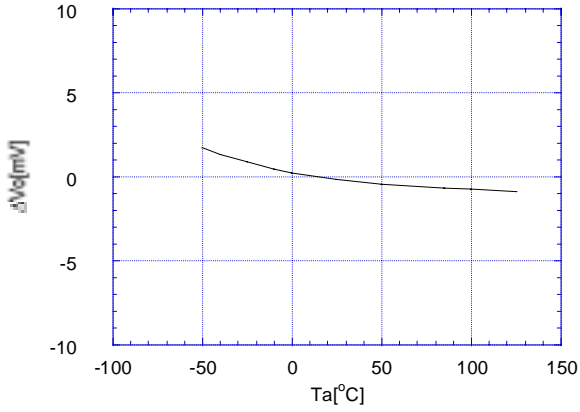

Output Power vs. Temperature
($V^+ = 6V$)

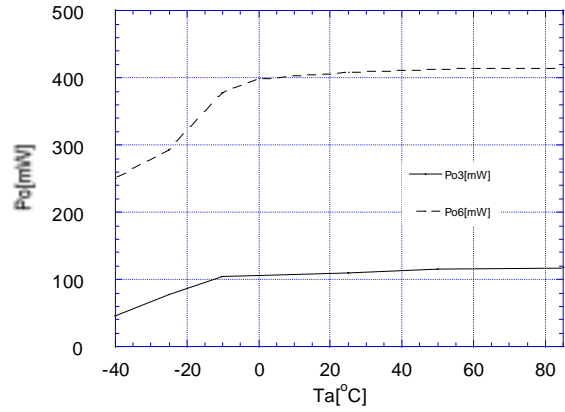

MEMO

[CAUTION]
 The specifications on this databook are only given for information, without any guarantee as regards either mistakes or omissions. The application circuits in this databook are described only to show representative usages of the product and not intended for the guarantee or permission of any right

Mouser Electronics

Authorized Distributor

Click to View Pricing, Inventory, Delivery & Lifecycle Information:

[NJR:](#)

[NJM2149D](#) [NJM2149M](#) [NJM2149RB1-TE1](#) [NJM2149V-TE2](#) [NJM2149V-TE1](#) [NJM2149R-TE1](#) [NJM2149R-TE2](#)
[NJM2149M-TE2](#) [NJM2149M-TE1](#) [NJM2149RB1-TE2](#)



Стандарт Электрон Связь

Мы молодая и активно развивающаяся компания в области поставок электронных компонентов. Мы поставляем электронные компоненты отечественного и импортного производства напрямую от производителей и с крупнейших складов мира.

Благодаря сотрудничеству с мировыми поставщиками мы осуществляем комплексные и плановые поставки широчайшего спектра электронных компонентов.

Собственная эффективная логистика и склад в обеспечивает надежную поставку продукции в точно указанные сроки по всей России.

Мы осуществляем техническую поддержку нашим клиентам и предпродажную проверку качества продукции. На все поставляемые продукты мы предоставляем гарантию .

Осуществляем поставки продукции под контролем ВП МО РФ на предприятия военно-промышленного комплекса России , а также работаем в рамках 275 ФЗ с открытием отдельных счетов в уполномоченном банке. Система менеджмента качества компании соответствует требованиям ГОСТ ISO 9001.

Минимальные сроки поставки, гибкие цены, неограниченный ассортимент и индивидуальный подход к клиентам являются основой для выстраивания долгосрочного и эффективного сотрудничества с предприятиями радиоэлектронной промышленности, предприятиями ВПК и научно-исследовательскими институтами России.

С нами вы становитесь еще успешнее!

Наши контакты:

Телефон: +7 812 627 14 35

Электронная почта: sales@st-electron.ru

Адрес: 198099, Санкт-Петербург,
Промышленная ул, дом № 19, литера Н,
помещение 100-Н Офис 331