

# Micropower Precision Shunt Voltage Reference

## FEATURES

- **Initial Voltage Accuracy: 0.05%**
- **Low Operating Current: 10 $\mu$ A**
- **Low Drift: 10ppm/ $^{\circ}$ C Max**
- Less Than 1 $\Omega$  Dynamic Impedance
- Available in 1.25V, 2.5V, 4.096V and 5V in SO-8 and TO-92 Packages
- 1.25V and 2.5V Available in MSOP Package
- Both Commercial and Industrial Temperature Range Parts Are Available

## APPLICATIONS

- Portable Meters
- Precision Regulators
- A/D and D/A Converters
- Calibrators

## DESCRIPTION

The LT<sup>®</sup>1634 is a micropower, precision, shunt voltage reference. The bandgap reference uses trimmed precision thin film resistors to achieve 0.05% initial voltage accuracy. Improved curvature correction technique guarantees 10ppm/ $^{\circ}$ C maximum temperature drift. Advances in design, processing and packaging techniques guarantee 10 $\mu$ A operation and low temperature cycling hysteresis. The LT1634 does not require an output compensation capacitor, but is stable with capacitive loads. Low dynamic impedance makes the LT1634 reference easy to use from unregulated supplies.

The LT1634 reference can be used as a high performance upgrade to the LM185/LM385, LT1004 and LT1034 where lower power and guaranteed temperature drift is required.

 LTC and LT are registered trademarks of Linear Technology Corporation.

## TYPICAL APPLICATION

### Super Accurate $\pm 4.096V$ Output References

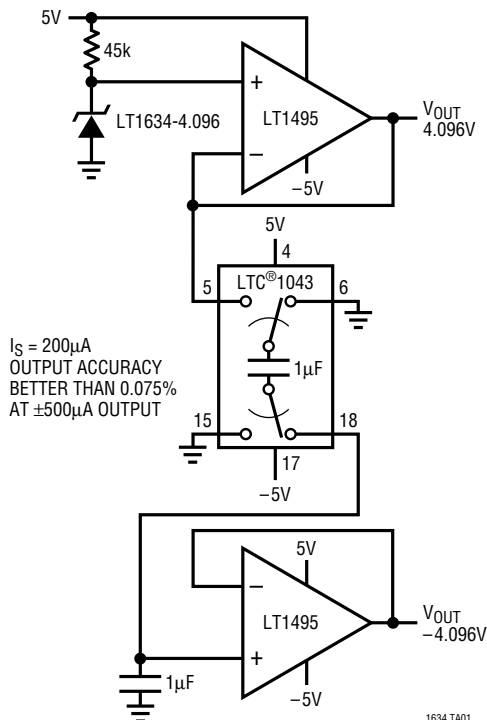

### Temperature Drift

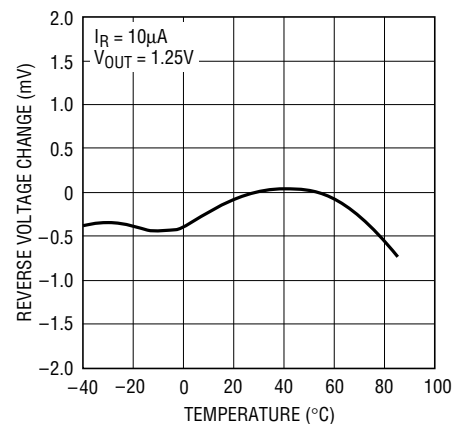

**ABSOLUTE MAXIMUM RATINGS**

Operating Current

1.25V .....	100mA
2.5V .....	50mA
4.096V, 5V .....	30mA
Forward Current .....	20mA

Operating Temperature Range

Commercial .....	0°C to 70°C
Industrial .....	-40°C to 85°C
Storage Temperature Range (Note 1) ...	-65°C to 150°C
Lead Temperature (Soldering, 10 sec) .....	300°C

**PACKAGE/ORDER INFORMATION**

<p>MS8 PACKAGE 8-LEAD PLASTIC MSOP T<sub>JMAX</sub> = 125°C, θ<sub>JA</sub> = 250°C/W</p>		<p>S8 PACKAGE 8-LEAD PLASTIC SO T<sub>JMAX</sub> = 125°C, θ<sub>JA</sub> = 190°C/W</p>	
ORDER PART NUMBER	MS8 PART MARKING	ORDER PART NUMBER	S8 PART MARKING
LT1634BCMS8-1.25 LT1634BCMS8-2.5	LTCV LTDF	LT1634ACS8-1.25 LT1634ACS8-2.5 LT1634ACS8-4.096 LT1634ACS8-5 LT1634AIS8-1.25 LT1634AIS8-2.5 LT1634AIS8-4.096 LT1634AIS8-5 LT1634BCS8-1.25 LT1634BCS8-2.5 LT1634BCS8-4.096 LT1634BCS8-5 LT1634BIS8-1.25 LT1634BIS8-2.5 LT1634BIS8-4.096 LT1634BIS8-5	634A1 634A2 634A4 634A5 634AI1 634AI2 634AI4 634AI5 634B1 634B2 634B4 634B5 634BI1 634BI2 634BI4 634BI5
<p>Z PACKAGE 3-LEAD PLASTIC TO-92 T<sub>JMAX</sub> = 125°C, θ<sub>JA</sub> = 190°C/W</p>		<p>ORDER PART NUMBER</p> <p>LT1634CCZ-1.25 LT1634CCZ-2.5 LT1634CCZ-4.096 LT1634CCZ-5</p>	

\*Connected internally. Do Not Connect external circuitry to these pins.

\*\*Connect to ground in user application.

Consult factory for Military grade parts.

## AVAILABLE OPTIONS

TEMPERATURE	ACCURACY (%)	TEMPERATURE COEFFICIENT (ppm/°C)	PACKAGE TYPE		
			MS8	S8	Z
0°C to 70°C	0.05	10		LT1634ACS8-1.25 LT1634ACS8-2.5 LT1634ACS8-4.096 LT1634ACS8-5	
-40°C to 85°C	0.05	10		LT1634AIS8-1.25 LT1634AIS8-2.5 LT1634AIS8-4.096 LT1634AIS8-5	
0°C to 70°C	0.05	25	LT1634BCMS8-1.25 LT1634BCMS8-2.5	LT1634BCS8-1.25 LT1634BCS8-2.5 LT1634BCS8-4.096 LT1634BCS8-5	
-40°C to 85°C	0.05	25		LT1634BIS8-1.25 LT1634BIS8-2.5 LT1634BIS8-4.096 LT1634BIS8-5	
0°C to 70°C	0.20	25			LT1634CCZ-1.25 LT1634CCZ-2.5 LT1634CCZ-4.096 LT1634CCZ-5

## 1.25V ELECTRICAL CHARACTERISTICS (Note 2)

PARAMETER	CONDITIONS	MIN	TYP	MAX	UNITS
Reverse Breakdown Voltage	LT1634ACS8/LT1634BCMS8/LT1634BCS8/ LT1634AIS8/LT1634BIS8 ( $I_R = 10\mu A$ )	1.24937 -0.05	1.250	1.25062 0.05	V %
	LT1634CCZ ( $I_R = 10\mu A$ )	1.24750 -0.20	1.250	1.25250 0.20	V %
	LT1634ACS8 ( $I_R = 10\mu A$ )	● 1.24849 -0.12	1.250	1.25149 0.12	V %
	LT1634AIS8 ( $I_R = 10\mu A$ )	● 1.24781 -0.175	1.250	1.25218 0.175	V %
	LT1634BCS8/LT1634BCMS8 ( $I_R = 10\mu A$ )	● 1.24718 -0.225	1.250	1.25281 0.225	V %
	LT1634BIS8 ( $I_R = 10\mu A$ )	● 1.24547 -0.362	1.250	1.25453 0.362	V %
	LT1634CCZ ( $I_R = 10\mu A$ )	● 1.24531 -0.375	1.250	1.25469 0.375	V %
Reverse Breakdown Change with Current (Note 3)	$10\mu A \leq I_R \leq 2mA$	●	0.25 0.30	1 2	mV mV
	$2mA \leq I_R \leq 20mA$	●	2 2	8 10	mV mV
Minimum Operating Current		●		7	$\mu A$
Temperature Coefficient	LT1634A, $I_R = 10\mu A$	●	4	10	ppm/°C
	LT1634B, $I_R = 10\mu A$	●	10	25	ppm/°C
Reverse Dynamic Impedance (Note 4)	$10\mu A \leq I_R \leq 2mA$	●	0.125 0.150	0.5 1.0	$\Omega$ $\Omega$
Low Frequency Noise (Note 5)	$I_R = 10\mu A, 0.1Hz \leq f \leq 10Hz$		10		$\mu V_{P-P}$
Hysteresis (Note 6)	$\Delta T = -40^\circ C$ to $85^\circ C$		160		ppm
	$\Delta T = 0^\circ C$ to $70^\circ C$		40		ppm

## 2.5V ELECTRICAL CHARACTERISTICS (Note 2)

PARAMETER	CONDITIONS	MIN	TYP	MAX	UNITS
Reverse Breakdown Voltage	LT1634ACS8/LT1634BCMS8/LT1634BCS8/ LT1634AIS8/LT1634BIS8 ( $I_R = 10\mu\text{A}$ )	2.49875 -0.05	2.500	2.50125 0.05	V %
	LT1634CCZ ( $I_R = 10\mu\text{A}$ )	2.49500 -0.20	2.500	2.50500 0.20	V %
	LT1634ACS8 ( $I_R = 10\mu\text{A}$ )	● 2.49700 -0.12	2.500	2.50300 0.12	V %
	LT1634AIS8 ( $I_R = 10\mu\text{A}$ )	● 2.49562 -0.175	2.500	2.50437 0.175	V %
	LT1634BCMS8/LT1634BCS8 ( $I_R = 10\mu\text{A}$ )	● 2.49437 -0.225	2.500	2.50562 0.225	V %
	LT1634BIS8 ( $I_R = 10\mu\text{A}$ )	● 2.49094 -0.362	2.500	2.50906 0.362	V %
	LT1634CCZ ( $I_R = 10\mu\text{A}$ )	● 2.49062 -0.375	2.500	2.50937 0.375	V %
Reverse Breakdown Change with Current (Note 3)	$10\mu\text{A} \leq I_R \leq 2\text{mA}$	●	0.30 0.40	1.5 3.0	mV mV
	$2\text{mA} \leq I_R \leq 20\text{mA}$	●	2 2	8 10	mV mV
Minimum Operating Current		●		8	$\mu\text{A}$
Temperature Coefficient	LT1634A, $I_R = 10\mu\text{A}$	●	4	10	ppm/ $^{\circ}\text{C}$
	LT1634B, $I_R = 10\mu\text{A}$	●	10	25	ppm/ $^{\circ}\text{C}$
Reverse Dynamic Impedance (Note 4)	$10\mu\text{A} \leq I_R \leq 2\text{mA}$	●	0.15 0.20	0.75 1.50	$\Omega$ $\Omega$
Low Frequency Noise (Note 5)	$I_R = 10\mu\text{A}$ , $0.1\text{Hz} \leq f \leq 10\text{Hz}$		15		$\mu\text{V}_{\text{P-P}}$
Hysteresis (Note 6)	$\Delta T = -40^{\circ}\text{C}$ to $85^{\circ}\text{C}$		160		ppm
	$\Delta T = 0^{\circ}\text{C}$ to $70^{\circ}\text{C}$		40		ppm

## 4.096V ELECTRICAL CHARACTERISTICS (Note 2)

PARAMETER	CONDITIONS	MIN	TYP	MAX	UNITS
Reverse Breakdown Voltage	LT1634ACS8/LT1634BCS8/ LT1634AIS8/LT1634BIS8 ( $I_R = 20\mu\text{A}$ )	4.09395 -0.05	4.096	4.09805 0.05	V %
	LT1634CCZ ( $I_R = 20\mu\text{A}$ )	4.08780 -0.20	4.096	4.10419 0.20	V %
	LT1634ACS8 ( $I_R = 20\mu\text{A}$ )	● 4.09108 -0.12	4.096	4.10091 0.12	V %
	LT1634AIS8 ( $I_R = 20\mu\text{A}$ )	● 4.08883 -0.175	4.096	4.10317 0.175	V %
	LT1634BCS8 ( $I_R = 20\mu\text{A}$ )	● 4.08678 -0.225	4.096	4.10522 0.225	V %
	LT1634BIS8 ( $I_R = 20\mu\text{A}$ )	● 4.08115 -0.362	4.096	4.11085 0.362	V %
	LT1634CCZ ( $I_R = 20\mu\text{A}$ )	● 4.08064 -0.375	4.096	4.11137 0.375	V %
Reverse Breakdown Change with Current (Note 3)	$20\mu\text{A} \leq I_R \leq 2\text{mA}$	●	0.3 0.4	1.5 3.0	mV mV
	$2\text{mA} \leq I_R \leq 20\text{mA}$	●	2 2	8 10	mV mV
Minimum Operating Current		●		15	$\mu\text{A}$

## 4.096V ELECTRICAL CHARACTERISTICS (Note 2)

PARAMETER	CONDITIONS	MIN	TYP	MAX	UNITS
Temperature Coefficient	LT1634A, I <sub>R</sub> = 20μA	●	4	10	ppm/°C
	LT1634B, I <sub>R</sub> = 20μA	●	10	25	ppm/°C
Reverse Dynamic Impedance (Note 4)	20μA ≤ I <sub>R</sub> ≤ 2mA	●	0.15	0.75	Ω
			0.20	1.50	Ω
Low Frequency Noise (Note 5)	I <sub>R</sub> = 20μA, 0.1Hz ≤ f ≤ 10Hz		30		μV <sub>P-P</sub>
Hysteresis (Note 6)	ΔT = -40°C to 85°C ΔT = 0°C to 70°C		160		ppm
			40		ppm

## 5V ELECTRICAL CHARACTERISTICS (Note 2)

PARAMETER	CONDITIONS	MIN	TYP	MAX	UNITS	
Reverse Breakdown Voltage	LT1634ACS8/LT1634BCS8/ LT1634AIS8/LT1634BIS8 (I <sub>R</sub> = 20μA)		4.99750	5.000	5.00250	V
			-0.05		0.05	%
	LT1634CCZ (I <sub>R</sub> = 20μA)		4.99000	5.000	5.01000	V
			-0.20		0.20	%
	LT1634ACS8 (I <sub>R</sub> = 20μA)	●	4.99400	5.000	5.00600	V
			-0.12		0.12	%
	LT1634AIS8 (I <sub>R</sub> = 20μA)	●	4.99125	5.000	5.00875	V
		-0.175		0.175	%	
LT1634BCS8 (I <sub>R</sub> = 20μA)	●	4.98875	5.000	5.01125	V	
		-0.225		0.225	%	
LT1634BIS8 (I <sub>R</sub> = 20μA)	●	4.98188	5.000	5.01813	V	
		-0.362		0.362	%	
LT1634CCZ (I <sub>R</sub> = 20μA)	●	4.98126	5.000	5.01876	V	
		-0.375		0.375	%	
Reverse Breakdown Change with Current (Note 3)	20μA ≤ I <sub>R</sub> ≤ 2mA	●	0.3	1.5	mV	
			0.4	3.0	mV	
	2mA ≤ I <sub>R</sub> ≤ 20mA	●	2	8	mV	
			2	10	mV	
Minimum Operating Current				15	μA	
Temperature Coefficient	LT1634A, I <sub>R</sub> = 20μA LT1634B, I <sub>R</sub> = 20μA	●	4	10	ppm/°C	
			10	25	ppm/°C	
Reverse Dynamic Impedance (Note 4)	20μA ≤ I <sub>R</sub> ≤ 2mA	●	0.15	0.75	Ω	
			0.20	1.50	Ω	
Low Frequency Noise (Note 5)	I <sub>R</sub> = 20μA, 0.1Hz ≤ f ≤ 10Hz		35		μV <sub>P-P</sub>	
Hysteresis (Note 6)	ΔT = -40°C to 85°C ΔT = 0°C to 70°C		160		ppm	
			40		ppm	

The ● denotes specifications which apply over the full operating temperature range.

**Note 1:** If the part is stored outside of the specific operating temperature range, the output may shift due to hysteresis.

**Note 2:** ESD (Electrostatic Discharge) sensitive device. Use proper ESD handling precautions.

**Note 3:** Output requires 0.1μF for operating current greater than 1mA.

**Note 4:** This parameter is guaranteed by “reverse breakdown change with current” test.

**Note 5:** Peak-to-peak noise is measured with a single highpass filter at 0.1Hz and 2-pole lowpass filter at 10Hz.

**Note 6:** Hysteresis in output voltage is created by package stress that differs depending on whether the IC was previously at a higher or lower temperature. Output voltage is always measured at 25°C but the IC is cycled to 85°C or -40°C before successive measurements. Hysteresis is roughly proportional to the square of the temperature change. Hysteresis is not normally a problem for operational temperature excursions where the instrument might be stored at high or low temperature.

# 1.25V TYPICAL PERFORMANCE CHARACTERISTICS

**Reverse Characteristics**

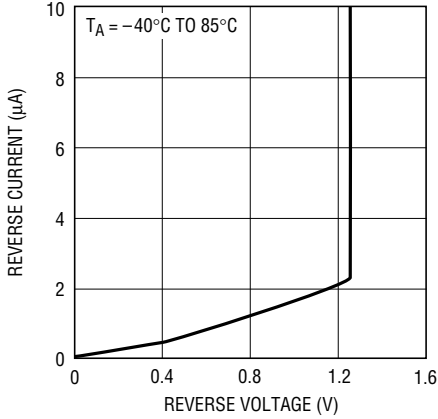

1634-1.25 G01

**Temperature Drift**

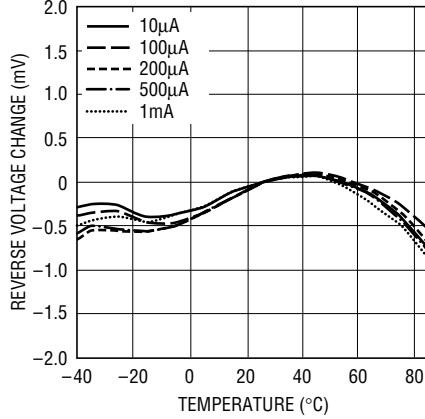

1634-1.25 TA02

**Reverse Voltage Change vs Current**

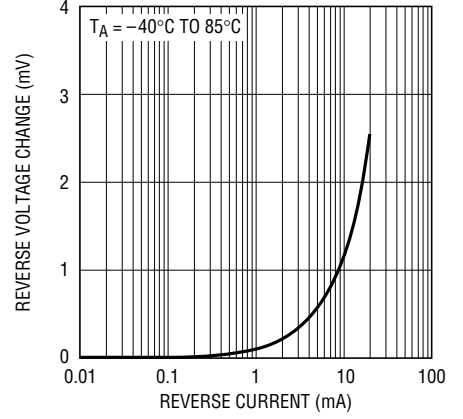

1634-1.25 G03

**Reverse Dynamic Impedance**

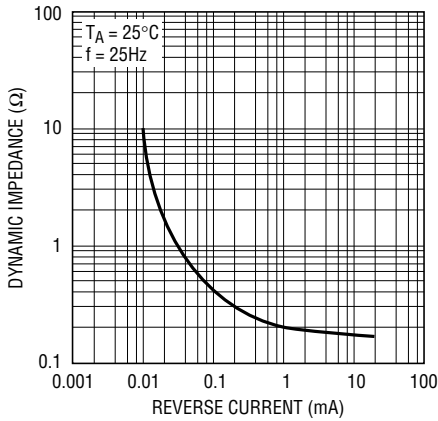

1634-1.25 G04

**Dynamic Impedance vs Frequency**

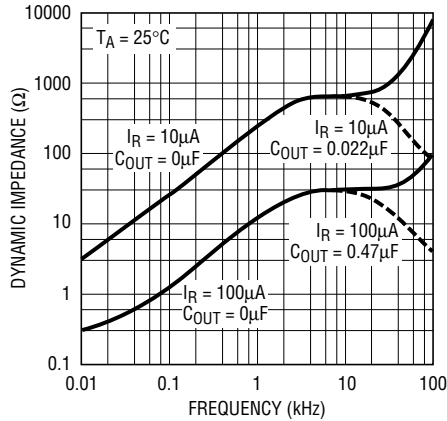

1634-1.25 G05

**Forward Characteristics**

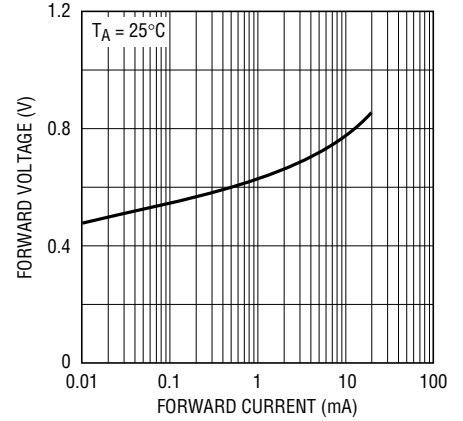

1634-1.25 G06

**0.1Hz to 10Hz Noise**

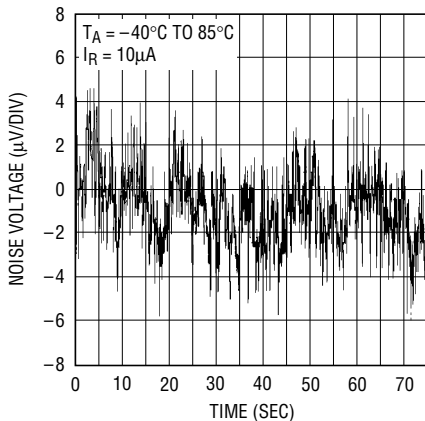

1634-1.25 G07

**Response Time**

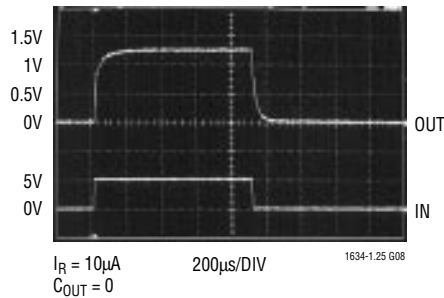

1634-1.25 G08

**Response Time**

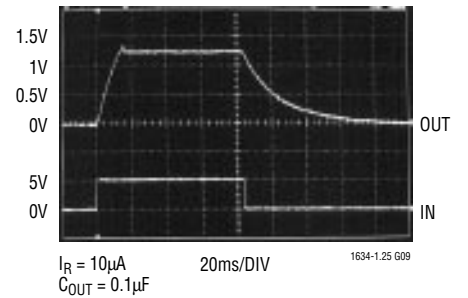

1634-1.25 G09

## 2.5V TYPICAL PERFORMANCE CHARACTERISTICS

**Reverse Characteristics**

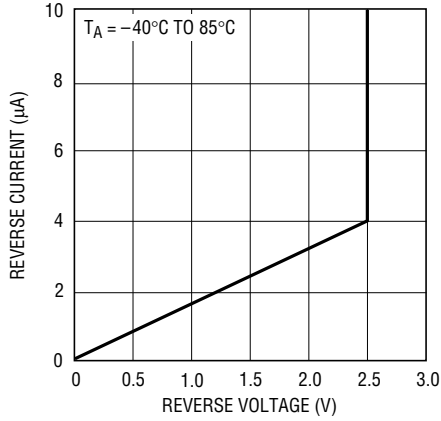

1634-2.5 G01

**Temperature Drift**

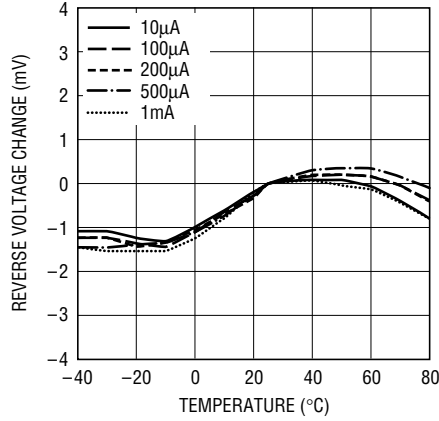

1634-2.5 G02

**Reverse Voltage Change vs Current**

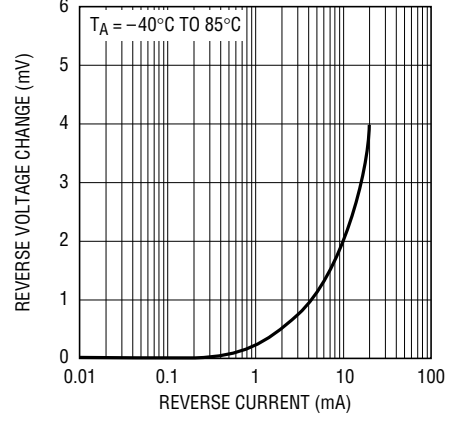

1634-2.5 G03

**Reverse Dynamic Impedance**

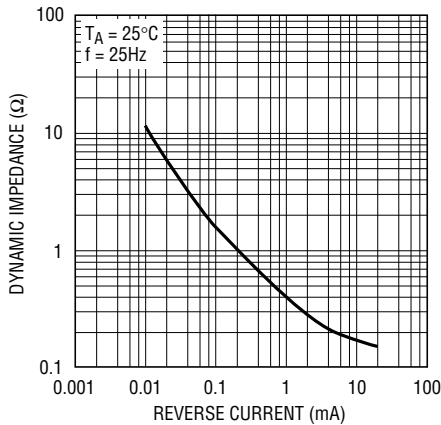

1634-2.5 G04

**Dynamic Impedance vs Frequency**

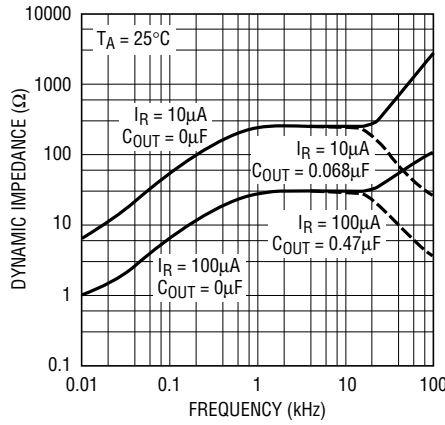

1634-2.5 G05

**Forward Characteristics**

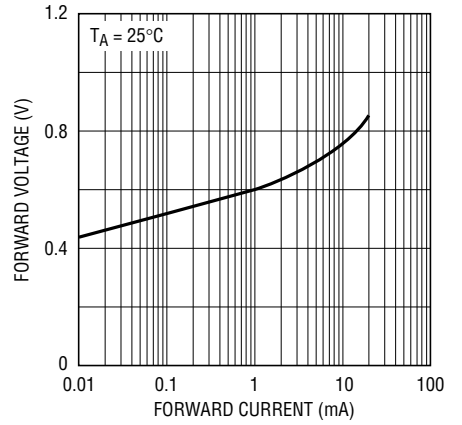

1634-2.5 G06

**0.1Hz to 10Hz Noise**

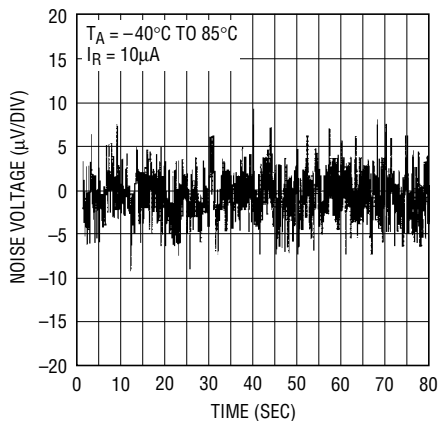

1634-2.5 G07

**Response Time**

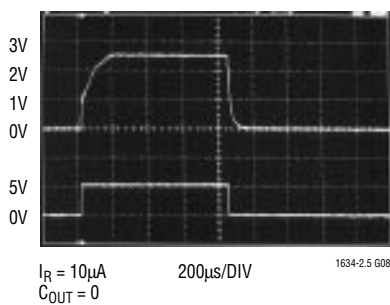

1634-2.5 G08

**Response Time**

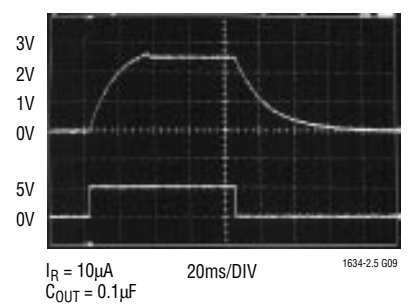

1634-2.5 G09

# 4.096V TYPICAL PERFORMANCE CHARACTERISTICS

**Reverse Characteristics**

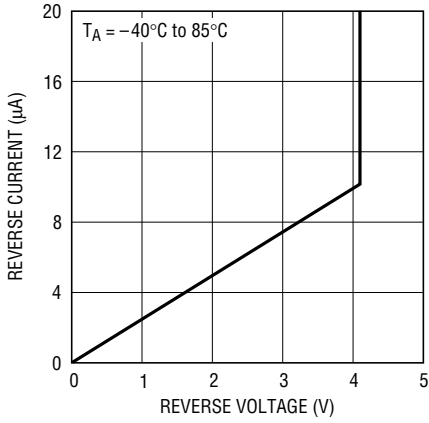

1634-4 G01

**Temperature Drift**

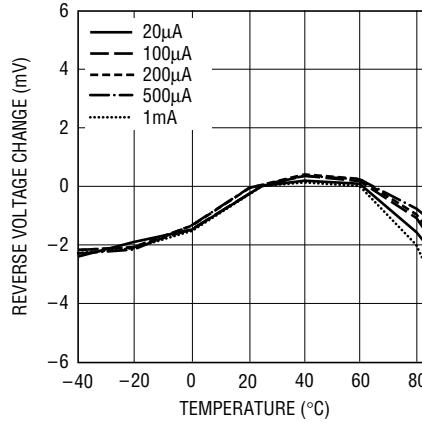

1634-4 G02

**Reverse Voltage Change vs Current**

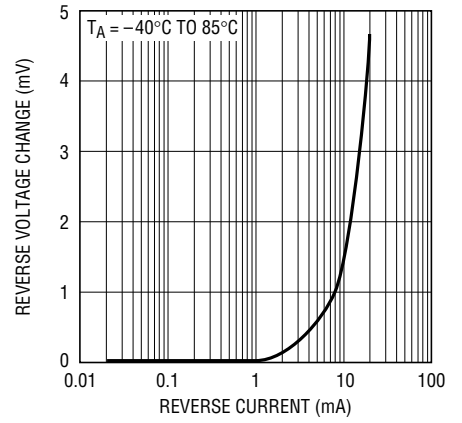

1634-4 G03

**Reverse Dynamic Impedance**

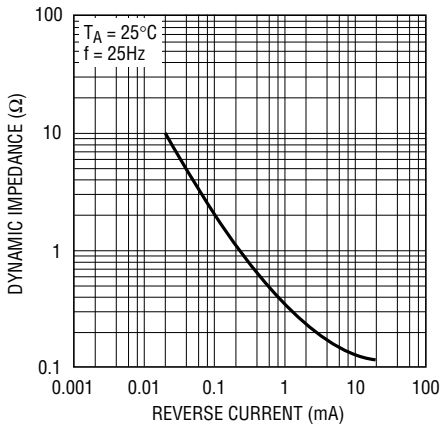

1634-4 G04

**Dynamic Impedance vs Frequency**

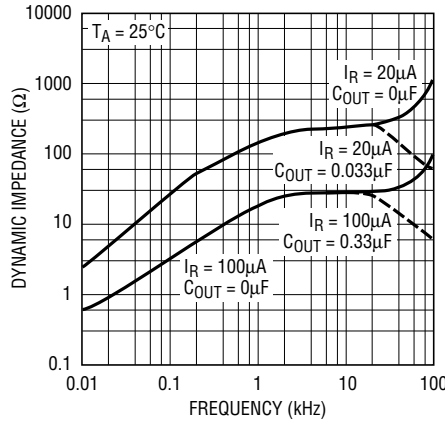

1634-4 G05

**Forward Characteristics**

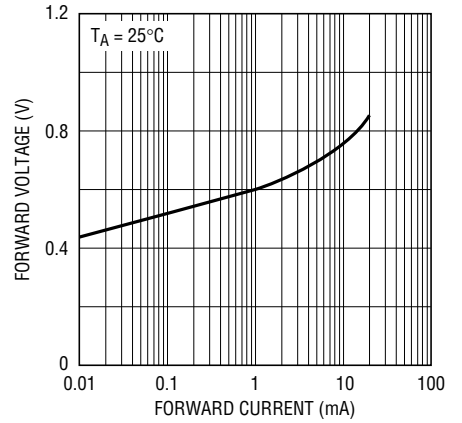

1634-2.5 G06

**0.1Hz to 10Hz Noise**

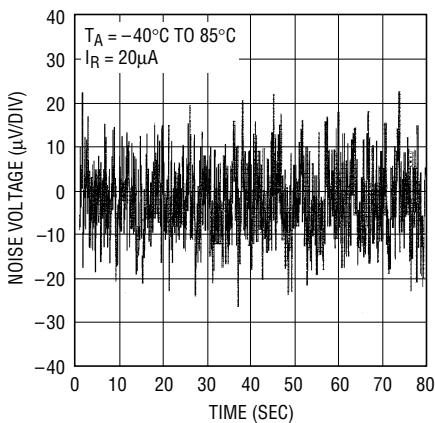

1634-4 G06

**Response Time**

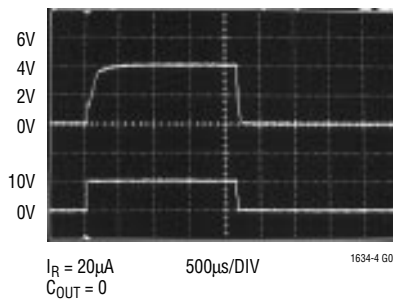

1634-4 G07

**Response Time**

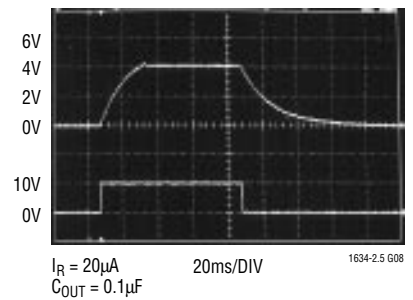

1634-2.5 G08



# 5V TYPICAL PERFORMANCE CHARACTERISTICS

**Reverse Characteristics**

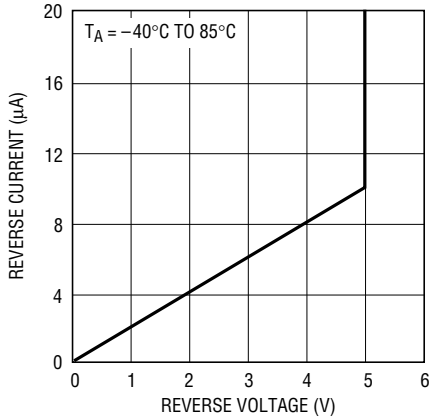

1634-5 G01

**Temperature Drift**

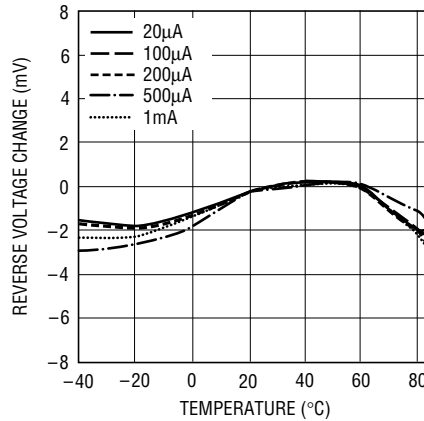

1634-5 G02

**Reverse Voltage Change vs Current**

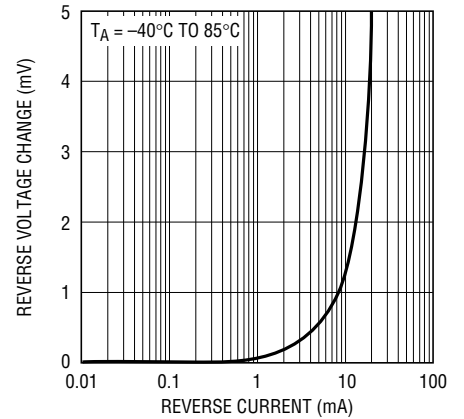

1634-5 G03

**Reverse Dynamic Impedance**

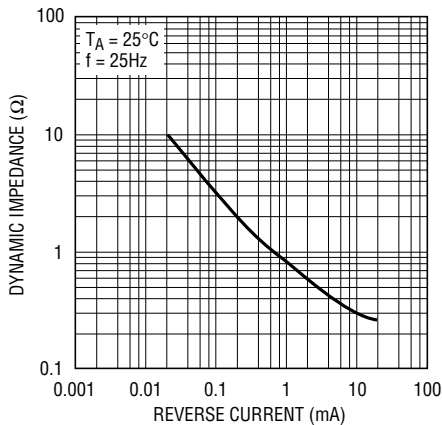

1634-5 G04

**Dynamic Impedance vs Frequency**

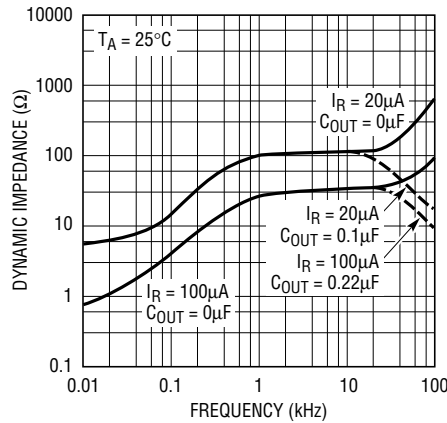

1634-5 G05

**Forward Characteristics**

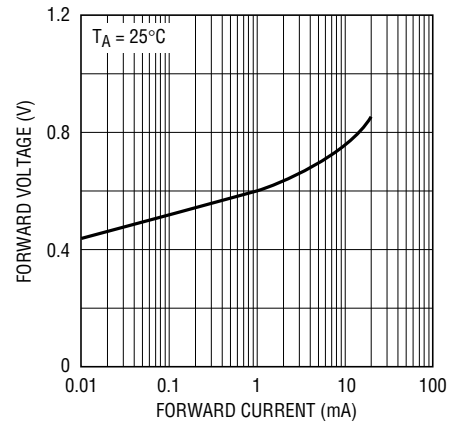

1634-2.5 G06

**0.1Hz to 10Hz Noise**

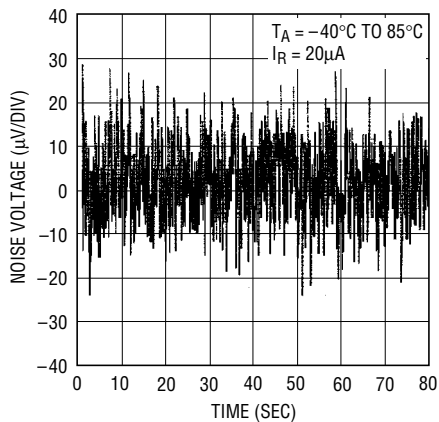

1634-5 G06

**Response Time**

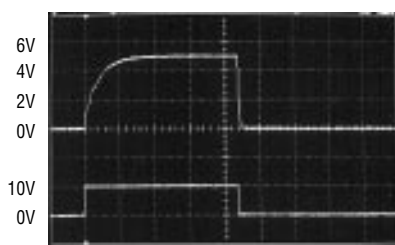

$I_R = 20\mu A$   
 $C_{OUT} = 0$  500µs/DIV

1634-5 G07

**Response Time**

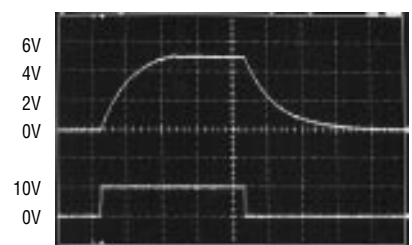

$I_R = 20\mu A$   
 $C_{OUT} = 0.1\mu F$  20ms/DIV

1634-5 G08

## APPLICATIONS INFORMATION

The reverse characteristics of the LT1634 behave like a resistor in parallel with a Zener diode. This simple, well behaved characteristic is important to the proper operation of circuits like Figure 1. The adjustable output voltage

reference depends upon positive feedback from the LT1495's output to start-up and regulate the bias current for the LT1634.

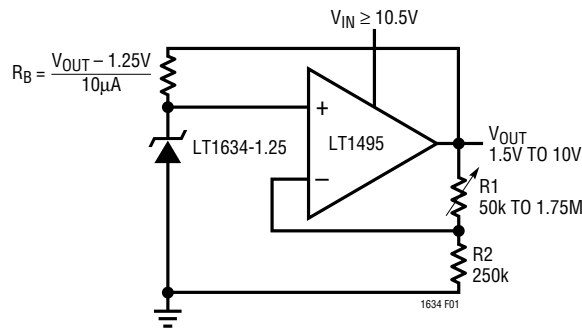
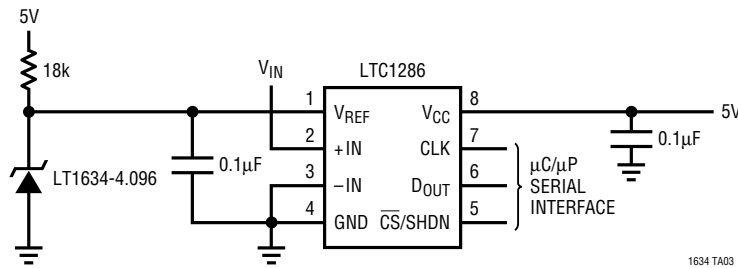

Figure 1. Adjustable Output Voltage Reference

## TYPICAL APPLICATIONS

### Reference for Micropower A/D Converter



### The LT1634-5 Generates the LTC1448 Dual 12-Bit DAC's Reference and Supply Voltage

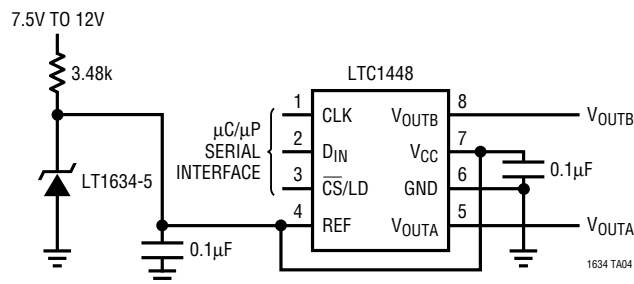



TYPICAL APPLICATIONS

Single Cell Li-Ion Battery Supervisory Circuit ( $I_Q = 20\mu A$ )

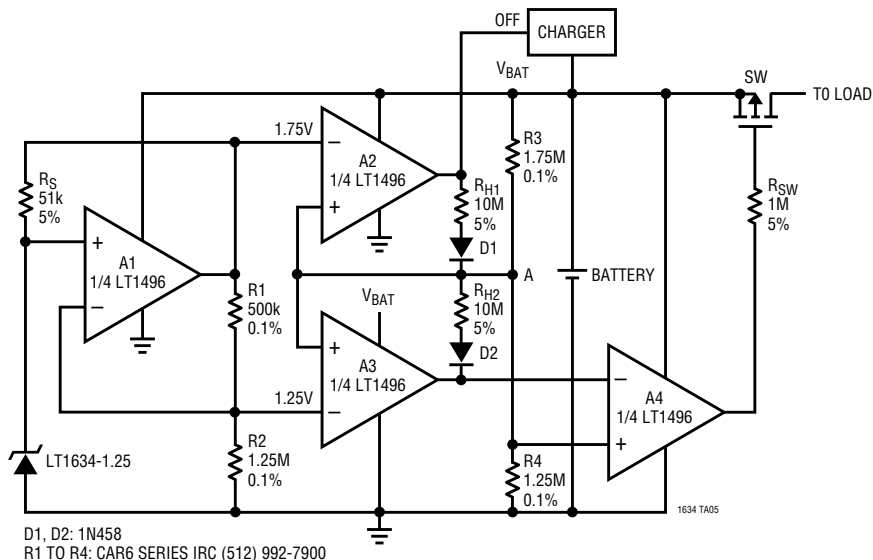

Micropower Voltage and Current Reference

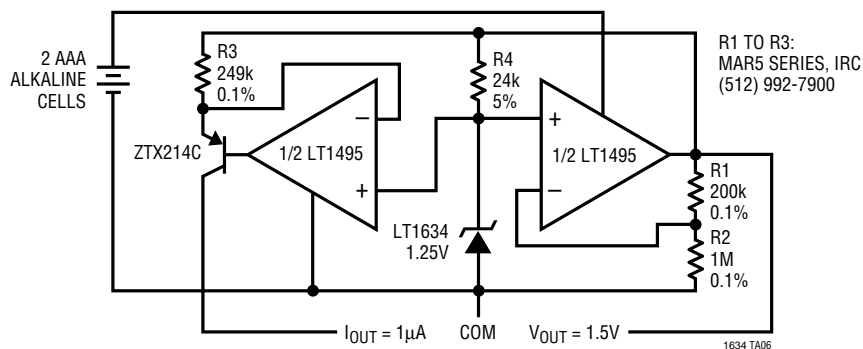

RELATED PARTS

PART NUMBER	DESCRIPTION	COMMENTS
LTC1440	Micropower Comparator with Reference	3.7µA Max Supply Current, 1% 1.182V Reference, MSOP, PDIP and SO-8 Packages
LT1460	Micropower Series Reference	0.075% Max, 10ppm/°C Max Drift, 2.5V, 5V and 10V Versions, MSOP, PDIP, SO-8, SOT-23 and TO-92 Packages
LT1495	1.5µA Precision Rail-to-Rail Dual Op Amp	1.5µA Max Supply Current, 100pA Max $I_{OS}$
LTC1540	Nanopower Comparator with Reference	600nA Max Supply Current, 2% 1.182V Reference, MSOP and SO-8 Packages



## Стандарт Электрон Связь

Мы молодая и активно развивающаяся компания в области поставок электронных компонентов. Мы поставляем электронные компоненты отечественного и импортного производства напрямую от производителей и с крупнейших складов мира.

Благодаря сотрудничеству с мировыми поставщиками мы осуществляем комплексные и плановые поставки широчайшего спектра электронных компонентов.

Собственная эффективная логистика и склад в обеспечивает надежную поставку продукции в точно указанные сроки по всей России.

Мы осуществляем техническую поддержку нашим клиентам и предпродажную проверку качества продукции. На все поставляемые продукты мы предоставляем гарантию .

Осуществляем поставки продукции под контролем ВП МО РФ на предприятия военно-промышленного комплекса России , а также работаем в рамках 275 ФЗ с открытием отдельных счетов в уполномоченном банке. Система менеджмента качества компании соответствует требованиям ГОСТ ISO 9001.

Минимальные сроки поставки, гибкие цены, неограниченный ассортимент и индивидуальный подход к клиентам являются основой для выстраивания долгосрочного и эффективного сотрудничества с предприятиями радиоэлектронной промышленности, предприятиями ВПК и научно-исследовательскими институтами России.

С нами вы становитесь еще успешнее!

### Наши контакты:

**Телефон:** +7 812 627 14 35

**Электронная почта:** [sales@st-electron.ru](mailto:sales@st-electron.ru)

**Адрес:** 198099, Санкт-Петербург,  
Промышленная ул, дом № 19, литера Н,  
помещение 100-Н Офис 331