

Photomicrosensor with 50- to 100-mA direct switching capacity for built-in application.

- Series includes models that enable switching between dark-ON and light-ON operation.
- Response frequency as high as 1 kHz.
- Easy operation monitoring with bright light indicator.
- Wide operating voltage range: 5 to 24 VDC
- Models in which the light indicator turns ON for dark-ON operation are also available.
- A wide range of variations in eight different shapes.
- Flexible robot cable is provided as a standard feature. *2

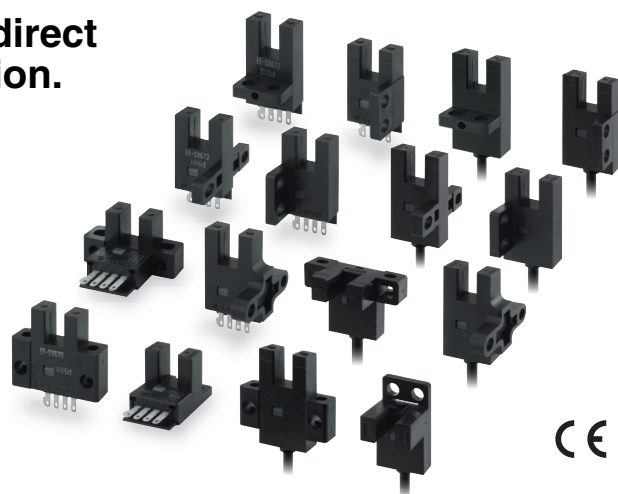

Be sure to read *Safety Precautions* on page 5.









*1. Pre-wired Models are available only in the EE-SX67 Series.

*2. Only for Pre-wired Models and Pre-wired Connector Models.

Ordering Information

Connector









 Infrared light

Appearance	Sensing method	Connect-ing method	Sensing distance	Output configuration	Indicator mode	Model	
						NPN output	PNP output
Standard 	Through-beam type (with slot)	Connector (4 poles)	 5 mm (slot width)	Dark-ON/Light-ON (selectable) *3	Incident light	EE-SX670	EE-SX670P
					No incident light	EE-SX670A	EE-SX670R
Light-ON				Incident light	EE-SX470	EE-SX470P	
				No incident light	EE-SX470A	EE-SX470R	
L-shaped 				Dark-ON/Light-ON (selectable) *3	Incident light	EE-SX671	EE-SX671P
					No incident light	EE-SX671A	EE-SX671R
Light-ON				Incident light	EE-SX471	EE-SX471P	
				No incident light	EE-SX471A	EE-SX471R	
T-shaped, slot center 7 mm 				Dark-ON/Light-ON (selectable) *3	Incident light	EE-SX672	EE-SX672P
					No incident light	EE-SX672A	EE-SX672R
Light-ON				Incident light	EE-SX472	EE-SX472P	
				No incident light	EE-SX472A	EE-SX472R	
Close-mounting 				Dark-ON/Light-ON (selectable) *3	Incident light	EE-SX673	EE-SX673P
					No incident light	EE-SX673A	EE-SX673R
Light-ON				Incident light	EE-SX473	EE-SX473P	
				No incident light	EE-SX473A	EE-SX473R	
Close-mounting 	Dark-ON/Light-ON (selectable) *3	Incident light	EE-SX674	EE-SX674P			
		No incident light	EE-SX674A	EE-SX674R			
Light-ON	Incident light	EE-SX474	EE-SX474P				
	No incident light	EE-SX474A	EE-SX474R				
T-shaped, slot center 10 mm 	Dark-ON/Light-ON (selectable) *3	Incident light	EE-SX675	EE-SX675P			
F-shaped 	Dark-ON/Light-ON (selectable) *3	Incident light	EE-SX676	EE-SX676P			
R-shaped 	Dark-ON/Light-ON (selectable) *3	Incident light	EE-SX677	EE-SX677P			

*3. Dark-ON when the L terminal of the connector is opened, and light-ON when the L terminal and positive (+) terminal are connected. Do not connect the L terminal to 0 V when using dark-ON operation. When using light-ON, it is useful to select the connector EE-1001-1. The L terminal and positive (+) terminal of this connector are connected in advance.

Pre-wired Models, Models with Connectors

Infrared light

Appearance	Sensing method	Sensing distance		Output configuration	Indicator mode	Connecting method	Model	
							NPN output	PNP output
Standard 	Through-beam type (with slot)			Dark-ON/ Light-ON (selectable) *	Incident light	Pre-wired Models (1m)	EE-SX670-WR 1M	EE-SX670P-WR 1M
						Models with connectors (0.1m)	EE-SX670-C1J-R 0.1M	EE-SX670P-C1J-R 0.1M
L-shaped 		Pre-wired Models (1m)	EE-SX671-WR 1M			EE-SX671P-WR 1M		
		Models with connectors (0.1m)	EE-SX671-C1J-R 0.1M			EE-SX671P-C1J-R 0.1M		
T-shaped, slot center 7 mm 		Pre-wired Models (1m)	EE-SX672-WR 1M			EE-SX672P-WR 1M		
		Models with connectors (0.1m)	EE-SX672-C1J-R 0.1M			EE-SX672P-C1J-R 0.1M		
Close-mounting 		Pre-wired Models (1m)	EE-SX673-WR 1M			EE-SX673P-WR 1M		
		Models with connectors (0.1m)	EE-SX673-C1J-R 0.1M			EE-SX673P-C1J-R 0.1M		
Close-mounting 		Pre-wired Models (1m)	EE-SX674-WR 1M			EE-SX674P-WR 1M		
		Models with connectors (0.1m)	EE-SX674-C1J-R 0.1M			EE-SX674P-C1J-R 0.1M		
T-shaped, slot center 10 mm 		Pre-wired Models (1m)	EE-SX675-WR 1M			EE-SX675P-WR 1M		
		Models with connectors (0.1m)	EE-SX675-C1J-R 0.1M			EE-SX675P-C1J-R 0.1M		
F-shaped 		Pre-wired Models (1m)	EE-SX676-WR 1M			EE-SX676P-WR 1M		
		Models with connectors (0.1m)	EE-SX676-C1J-R 0.1M			EE-SX676P-C1J-R 0.1M		
R-shaped 	Pre-wired Models (1m)	EE-SX677-WR 1M	EE-SX677P-WR 1M					
	Models with connectors (0.1m)	EE-SX677-C1J-R 0.1M	EE-SX677P-C1J-R 0.1M					

* Dark-ON operation can be used when the L terminal is left unconnected or Light-ON operation can be used when the L terminal and positive (+) terminal are connected to each other. Do not connect the L terminal to 0 V when using dark-ON operation.

Accessories (Order Separately) Connector Models

Type	Cable length	Model	Remarks
Connector		EE-1001	
		EE-1001-1	L terminal and positive (+) terminal are already short-circuited.
		EE-1009	
Connector with Cable	1 m	EE-1006	
		EE-1010	
	2 m	EE-1006	
		EE-1010	
Connector with Robot Cable	1 m	EE-1010-R	
	2 m	EE-1010-R	
Connector Hold-down Clip		EE-1006A	For EE-1006 only.

* Refer to *Accessories* for details.

Accessories (Order Separately) Models with Connectors

Type	Cable length	Model	Remarks
Connector with Robot Cable	2 m	EE-1016-R-1	For EE-SX67□-C1J-R only.

Ratings and Specifications

Item	Type		Standard	L-shaped	T-shaped, slot center 7 mm	Close-mounting		T-shaped, slot center 10 mm	F-shaped	R-shaped
	NPN models	Connector models	EE-SX670 EE-SX670A EE-SX470	EE-SX671 EE-SX671A EE-SX471	EE-SX672 EE-SX672A EE-SX472	EE-SX673 EE-SX673A EE-SX473	EE-SX674 EE-SX674A EE-SX474	EE-SX675	EE-SX676	EE-SX677
Pre-wired models		EE-SX670-WR	EE-SX671-WR	EE-SX672-WR	EE-SX673-WR	EE-SX674-WR	EE-SX675-WR	EE-SX676-WR	EE-SX677-WR	
Models with connectors		EE-SX670-CJ1-R	EE-SX671-CJ1-R	EE-SX672-CJ1-R	EE-SX673-CJ1-R	EE-SX674-CJ1-R	EE-SX675-CJ1-R	EE-SX676-CJ1-R	EE-SX677-CJ1-R	
PNP models	Connector models	EE-SX670P EE-SX670R EE-SX470P	EE-SX671P EE-SX671R EE-SX471P	EE-SX672P EE-SX672R EE-SX472P	EE-SX673P EE-SX673R EE-SX473P	EE-SX674P EE-SX674R EE-SX474P	EE-SX675P	EE-SX676P	EE-SX677P	
	Pre-wired models	EE-SX670P-WR	EE-SX671P-WR	EE-SX672P-WR	EE-SX673P-WR	EE-SX674P-WR	EE-SX675P-WR	EE-SX676P-WR	EE-SX677P-WR	
	Models with connectors	EE-SX670P-CJ1-R	EE-SX671P-CJ1-R	EE-SX672P-CJ1-R	EE-SX673P-CJ1-R	EE-SX674P-CJ1-R	EE-SX675P-CJ1-R	EE-SX676P-CJ1-R	EE-SX677P-CJ1-R	
Sensing distance		5 mm (slot width)								
Sensing object		Opaque: 2 × 0.8 mm min.								
Differential distance		0.025 mm								
Light source		GaAs infrared LED with a peak wavelength of 940 nm								
Indicator *1		Light indicator (red) (turns ON when light is interrupted for models with A or R suffix)								
Supply voltage		5 to 24 VDC ±10%, ripple (p-p): 10% max.								
Current consumption		35 mA max. (NPN models), 30 mA max. (PNP models)								
Control output		NPN open collector: 5 to 24 VDC, 100 mA max. 100 mA load current with a residual voltage of 0.8 V max. 40 mA load current with a residual voltage of 0.4 V max. OFF current: 0.5 mA max. PNP open collector: 5 to 24 VDC, 50 mA max. 50 mA load current with a residual voltage of 1.3 V max. OFF current: 0.5 mA max.								
Response frequency *2		1 kHz min. (3 kHz average)								
Ambient illumination		1,000 lx max. with fluorescent light on the surface of the receiver.								
Ambient temperature range		Operating: -25 to +55°C, Storage: -30 to +80°C (with no icing or condensation)								
Ambient humidity range		Operating: 5% to 85%, Storage: 5% to 95% (with no icing or condensation)								
Vibration resistance		Destruction: 20 to 2,000 Hz (peak acceleration: 100 m/s ²) 1.5-mm double amplitude for 2 h (4-min periods) each in X, Y, and Z directions								
Shock resistance		Destruction: 500 m/s ² for 3 times each in X, Y, and Z directions								
Degree of protection		IEC60529 IP50								
Connecting method		Connector Models (direct soldering possible), Pre-wired Models (Standard cable length: 1 m), Models with Connectors (Standard cable length: 0.1 m)								
Weight	Connector models	Approx. 3.1 g	Approx. 3 g	Approx. 2.4 g	Approx. 2.3 g	Approx. 3 g	Approx. 2.7 g	Approx. 2.2 g	Approx. 2.2 g	
	Pre-wired models	Approx. 18.9 g	Approx. 17.3 g	Approx. 17.8 g	Approx. 16.8 g	Approx. 17.1 g	Approx. 18.3 g	Approx. 16.9 g	Approx. 16.9 g	
	Models with connectors	Approx. 6.3 g	Approx. 4.7 g	Approx. 5.2 g	Approx. 4.2 g	Approx. 4.5 g	Approx. 5.7 g	Approx. 4.3 g	Approx. 4.3 g	
Material	Case	Polybutylene phthalate (PBT)								
	Cover	Polycarbonate								
	Emitter/receiver	Polycarbonate								

*1. The indicator is a GaP red LED (peak wavelength: 690 nm).

*2. The response frequency was measured by detecting the rotating disk shown at the right.

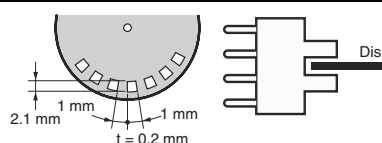

Connector for the EE-SX67 with Junction Connector

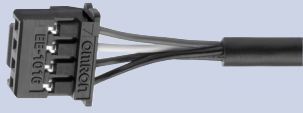
Product Model	Connector with Robot Cable	
	EE-1016-R-1	
Appearance		
Item		
Contact resistance	25 mΩ max. (at 10 mA DC and 20 mV max.)	
Insertion strength	20 N max.	
Surplus strength (housing holding strength)	15 N min.	
Cable length	2 m	
Ambient temperature range	-25 to +85°C	
Materials	Housing	Nylon
	Contact	Phosphor bronze

Engineering Data (Typical)

Sensing Position Characteristics

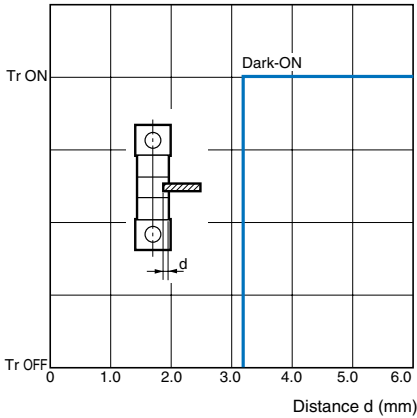

Sensing Position Characteristics

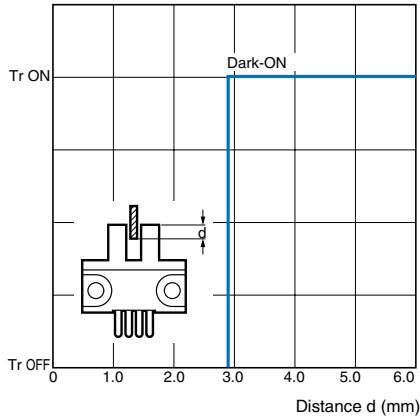

Repeated Sensing Position Characteristics

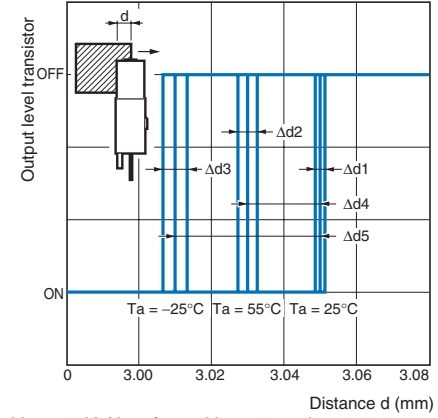

Vcc = 12 V, No. of repetitions: 20, Δd1 = 0.002 mm, Δd2 = 0.004 mm, Δd3 = 0.005 mm, Δd4 = 0.02 mm, Δd5 = 0.04 mm

Note: The data applies to dark status. Operation may be affected by external light interference or light coming through the sensing object.

I/O Circuit Diagrams

NPN Output

Model	Output configuration	Timing charts	Terminal connections	Output circuit
EE-SX67□ EE-SX67□-WR EE-SX67□-CJ1-R	Light-ON	Incident Interrupted Light indicator (red) ON OFF Output transistor ON OFF Load 1 Operates (e.g., relay) Releases Load 2 H L	Short-circuited between ⊕ terminal and positive ⊕ terminal	
	Dark-ON	Incident Interrupted Light indicator (red) ON OFF Output transistor ON OFF Load 1 Operates (e.g., relay) Releases Load 2 H L	Open between ⊕ terminal and positive ⊕ terminal *1	
EE-SX670A EE-SX671A EE-SX672A EE-SX673A EE-SX674A	Light-ON	Incident Interrupted Light indicator (red) ON OFF Output transistor ON OFF Load 1 Operates (e.g., relay) Releases Load 2 H L	Short-circuited between ⊕ terminal and positive ⊕ terminal	
	Dark-ON	Incident Interrupted Light indicator (red) ON OFF Output transistor ON OFF Load 1 Operates (e.g., relay) Releases Load 2 H L	Open between ⊕ terminal and positive ⊕ terminal *1	
EE-SX470 EE-SX471 EE-SX472 EE-SX473 EE-SX474	Light-ON	Incident Interrupted Light indicator (red) ON OFF Output transistor ON OFF Load 1 (relay) Operates Releases Load 2 H L	---	

*1. Do not connect the L terminal to 0 V when using dark-ON operation.

PNP Output

Model	Output configuration	Timing charts	Terminal connections	Output circuit
EE-SX67□P EE-SX67□P-WR EE-SX67□P-CJ1-R	Light-ON	Incident Interrupted Light indicator (red) ON OFF Output transistor ON OFF Load (relay) Operates Releases	Short-circuited between ⊖ terminal and positive ⊕ terminal	<p>*The terminal arrangement depends on the model. Check the dimensional diagrams.</p>
	Dark-ON	Incident Interrupted Light indicator (red) ON OFF Output transistor ON OFF Load (relay) Operates Releases	Open between ⊖ terminal and positive ⊕ terminal *1	
EE-SX670R EE-SX671R EE-SX672R EE-SX673R EE-SX674R	Light-ON	Incident Interrupted Light indicator (red) ON OFF Output transistor ON OFF Load (e.g., relay) Operates Releases	Short-circuited between ⊖ terminal and positive ⊕ terminal	
	Dark-ON	Incident Interrupted Light indicator (red) ON OFF Output transistor ON OFF Load (e.g., relay) Operates Releases	Open between ⊖ terminal and positive ⊕ terminal *1	
EE-SX470P EE-SX471P EE-SX472P EE-SX473P EE-SX474P	Light-ON	Incident Interrupted Light indicator (red) ON OFF Output transistor ON OFF Load (relay) Operates Releases	---	

*1. Do not connect the L terminal to 0 V when using dark-ON operation.

Safety Precautions

Refer to *Warranty and Limitations of Liability*.

⚠ WARNING

This product is not designed or rated for ensuring safety of persons either directly or indirectly. Do not use it for such purposes.

Precautions for Safe Use

● **Operating Environment**

These Photomicrosensors have an IP50 (conforms to IEC) enclosure and do not have a water-proof or dust-proof structure. Therefore, do not use them in applications in which the sensor will be subjected to splashes from water, oil, or any other liquid. Liquid entering the Sensor may result in malfunction.

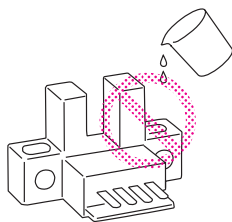

Precautions for Correct Use

Make sure that this product is used within the rated ambient environment conditions.

● **Installation**

- When direct soldering to the terminals, use the following guidelines.

Soldering Conditions

Item	Temperature	Permissible time	Remarks
Soldering iron	350°C max.	3 s max.	The portion between the base of the terminals and the position 1.5 mm from the terminal base must not be soldered.

- The terminal base uses a polycarbonate resin, which could be deformed by excessive soldering heat, resulting in damage to the product's functionality.

● **Lot Number and Model Number Legend**

In the following diagrams, 376d indicates the lot number and factory where the product was manufactured. Do not include this code with the model number when ordering.

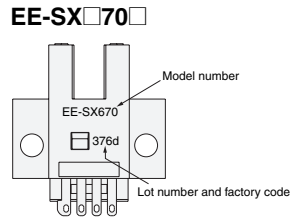

(Unit: mm)

Dimensions

Tolerance class IT16 applies to dimensions in this datasheet unless otherwise specified.

Sensors

EE-SX670/670P
EE-SX670A/670R
EE-SX470/470P

Terminal Arrangement

(1)	⊕	Vcc
(2)	L	L*
(3)	OUT	OUTPUT
(4)	⊖	GND (0 V)

* Pin 2 is not used for the EE-SX470.

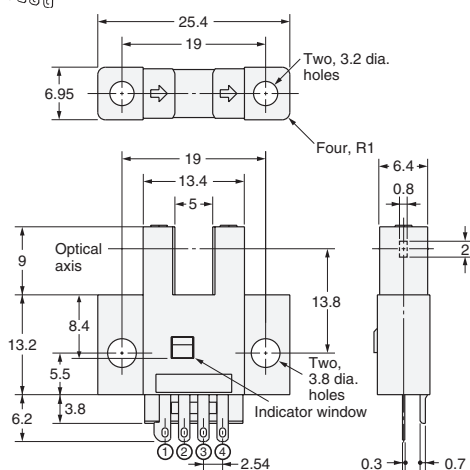
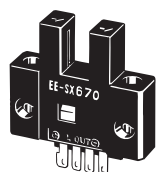

EE-SX671/671P
EE-SX671A/671R
EE-SX471/471P

Terminal Arrangement

(1)	⊕	Vcc
(2)	L	L*
(3)	OUT	OUTPUT
(4)	⊖	GND (0 V)

* Pin 2 is not used for the EE-SX471.

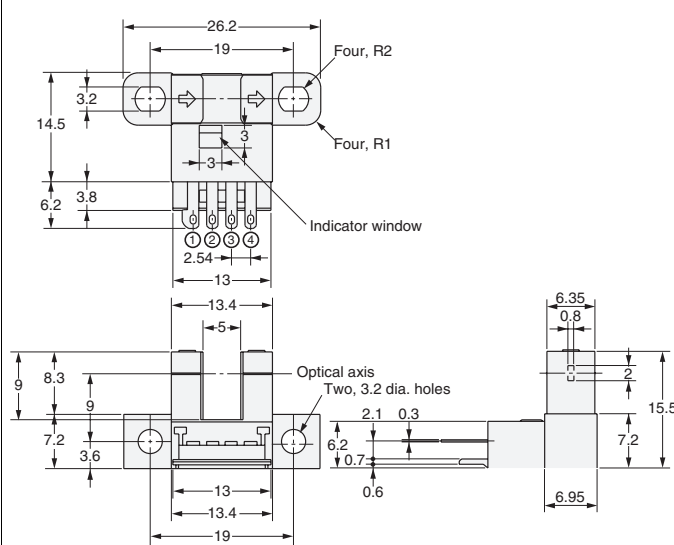
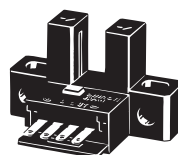

EE-SX672/672P
EE-SX672A/672R
EE-SX472/472P

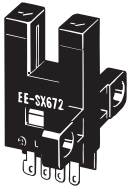

Terminal Arrangement

(1)	⊕	Vcc
(2)	L	L*
(3)	OUT	OUTPUT
(4)	⊖	GND (0 V)

* Pin 2 is not used for the EE-SX472.

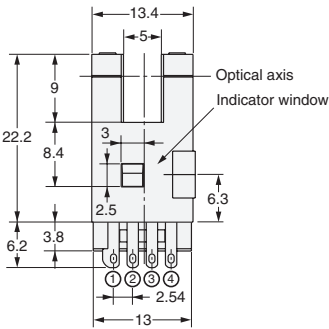
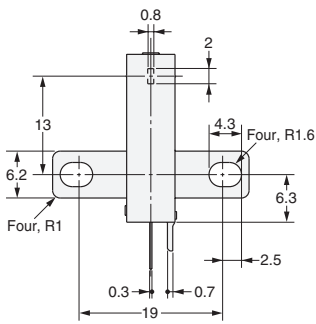
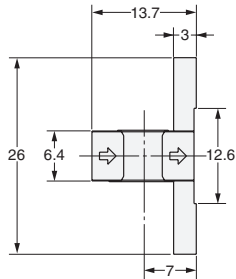

EE-SX673/673P
EE-SX673A/673R
EE-SX473/473P



Terminal Arrangement

(1)	⊕	Vcc
(2)	L	L*
(3)	OUT	OUTPUT
(4)	⊖	GND (0 V)

* Pin 2 is not used for the EE-SX473.

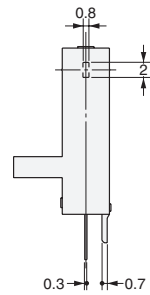
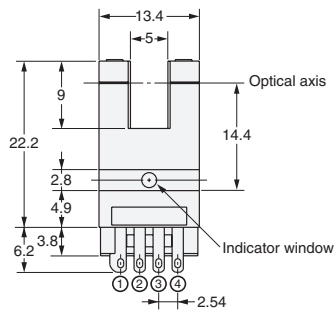
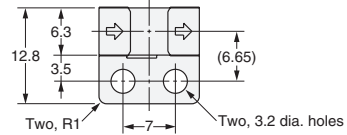

EE-SX674/674P EE-SX674A/674R EE-SX474/474P

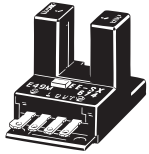

Terminal Arrangement

(1)	⊕	Vcc
(2)	L	L*
(3)	OUT	OUTPUT
(4)	⊖	GND (0 V)

* Pin 2 is not used for the EE-SX474.

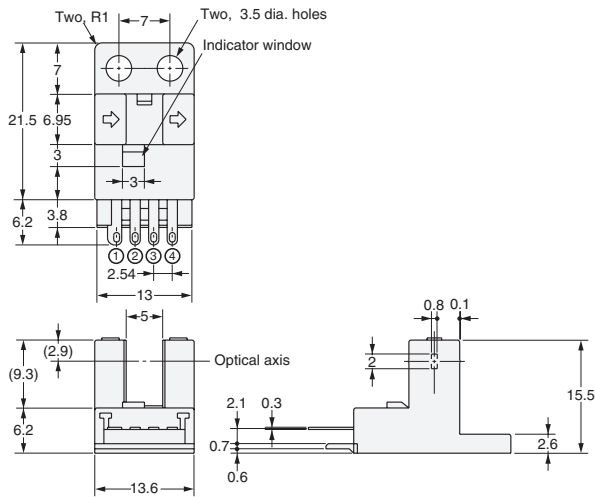

EE-SX675/675P



Terminal Arrangement

(1)	⊕	Vcc
(2)	L	L
(3)	OUT	OUTPUT
(4)	⊖	GND (0 V)

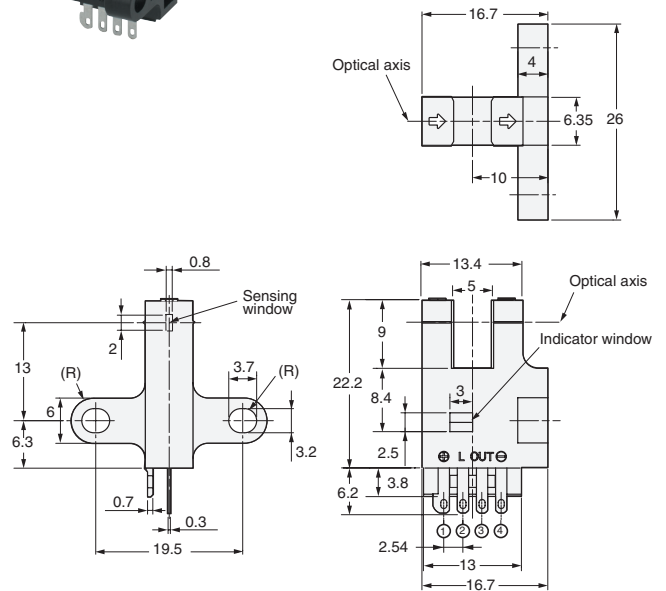

EE-SX676/676P



Terminal Arrangement

(1)	⊕	Vcc
(2)	L	L
(3)	OUT	OUTPUT
(4)	⊖	GND (0 V)

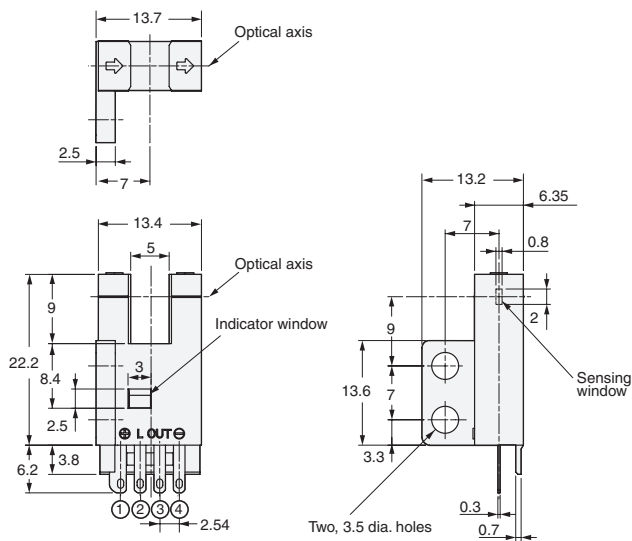

EE-SX677/677P



Terminal Arrangement

(1)	⊕	Vcc
(2)	L	L
(3)	OUT	OUTPUT
(4)	⊖	GND (0 V)

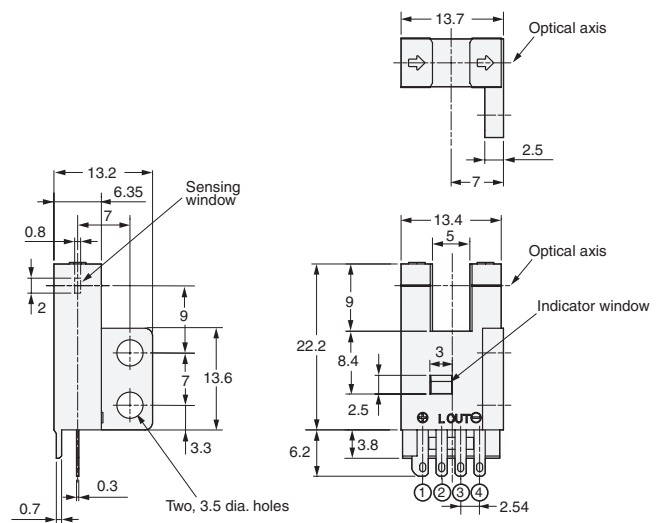

EE-SX670-WR/670P-WR
EE-SX670-C1J-R/670P-C1J-R

Terminal Arrangement

Brown	(1)	Vcc
Pink	(2)	L
Blue	(3)	GND (0 V)
Black	(4)	OUTPUT

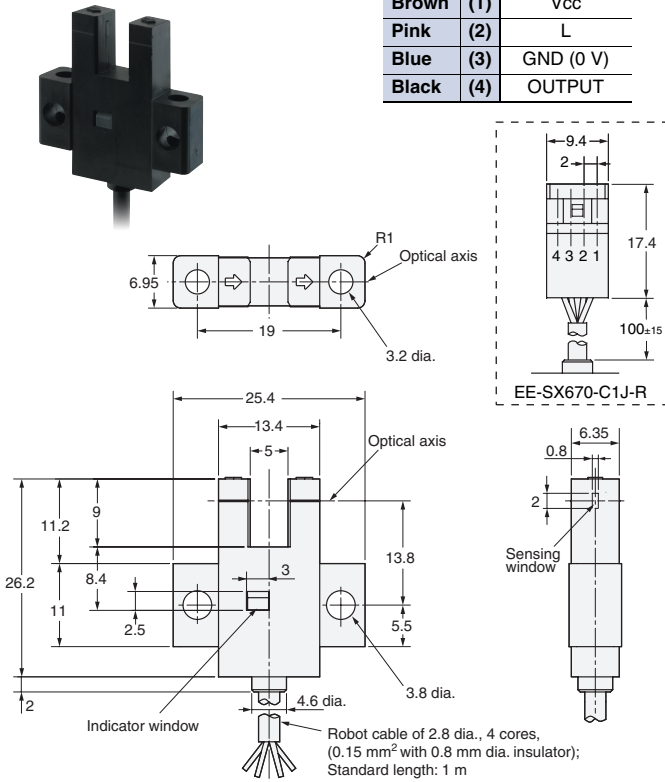

EE-SX671-WR/671P-WR
EE-SX671-C1J-R/671P-C1J-R

Terminal Arrangement

Brown	(1)	Vcc
Pink	(2)	L
Blue	(3)	GND (0 V)
Black	(4)	OUTPUT

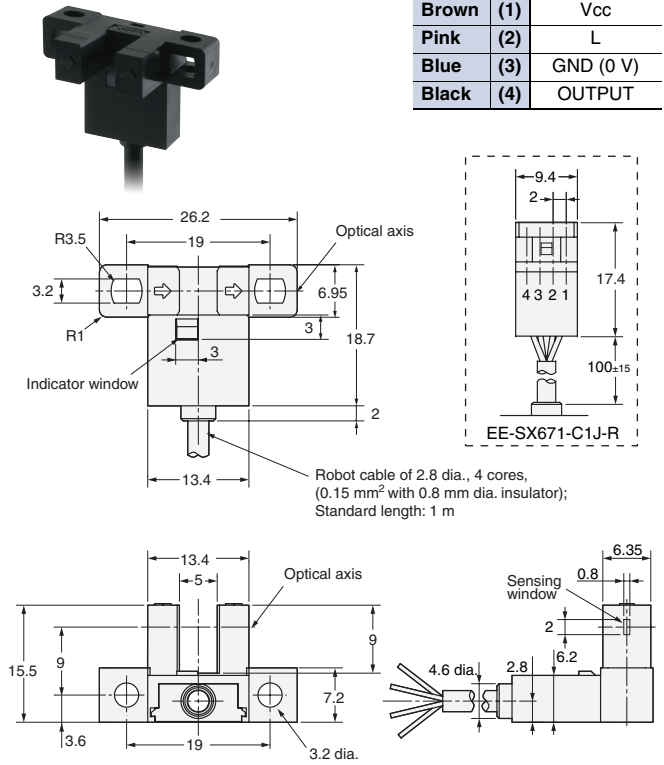

EE-SX672-WR/672P-WR
EE-SX672-C1J-R/672P-C1J-R

Terminal Arrangement

Brown	(1)	Vcc
Pink	(2)	L
Blue	(3)	GND (0 V)
Black	(4)	OUTPUT

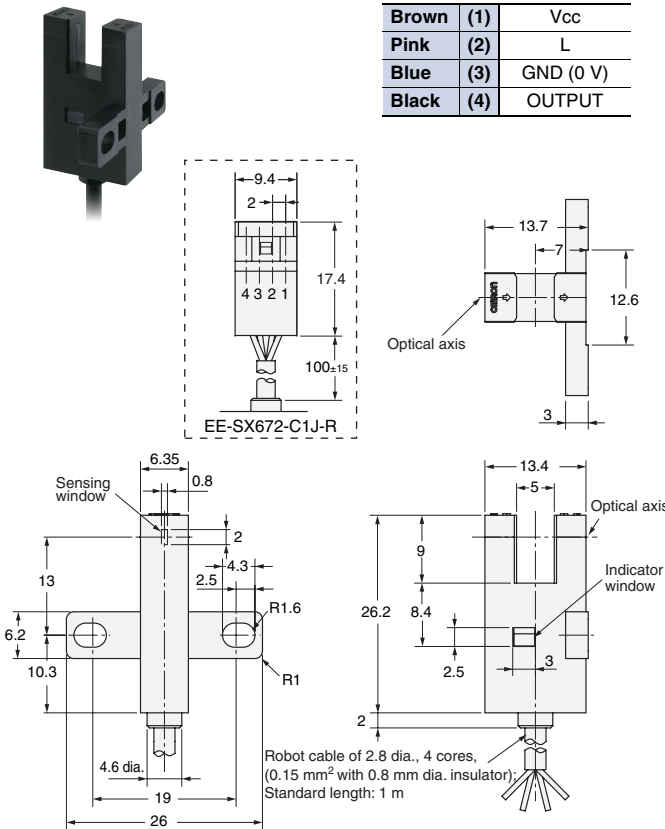

EE-SX673-WR/673P-WR
EE-SX673-C1J-R/673P-C1J-R

Terminal Arrangement

Brown	(1)	Vcc
Pink	(2)	L
Blue	(3)	GND (0 V)
Black	(4)	OUTPUT

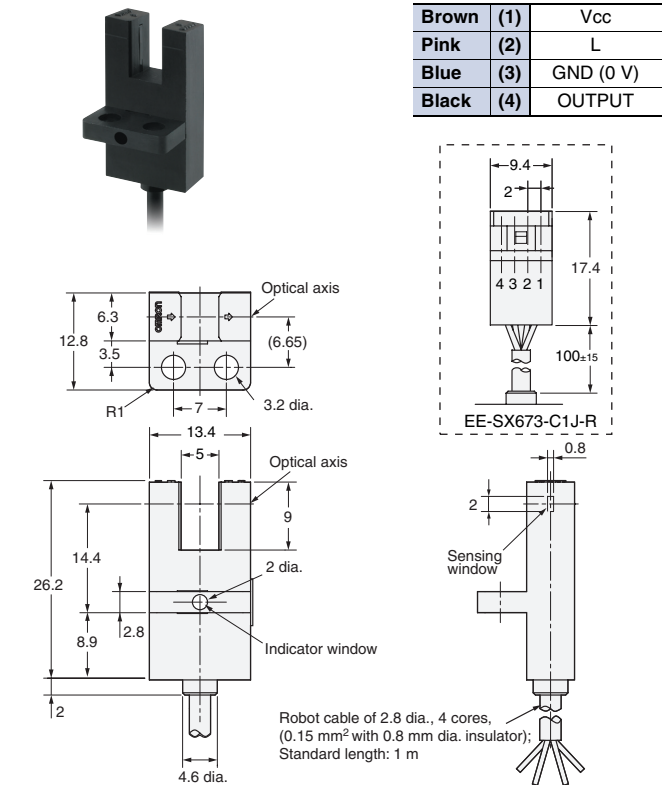

EE-SX674-WR/674P-WR EE-SX674-C1J-R/674P-C1J-R

Terminal Arrangement

Brown	(1)	Vcc
Pink	(2)	L
Blue	(3)	GND(0V)
Black	(4)	OUTPUT

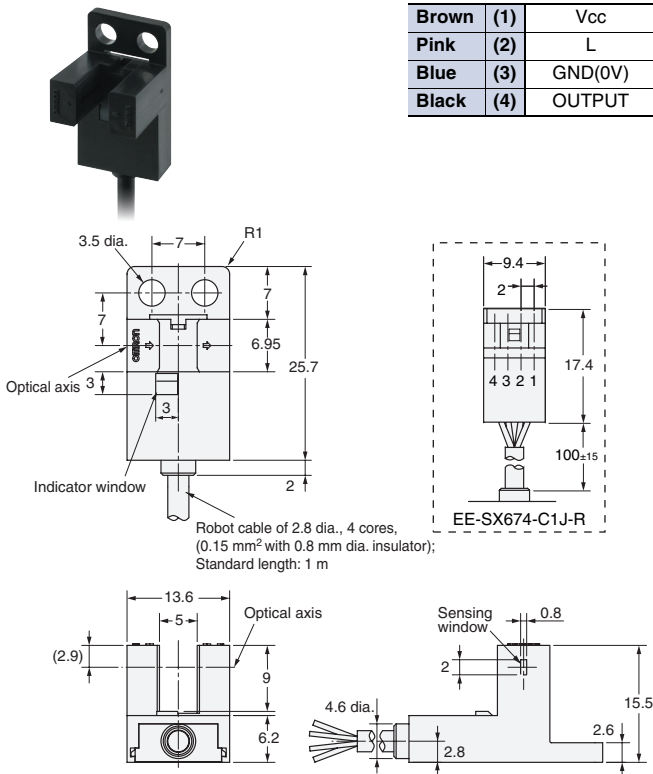

EE-SX675-WR/675P-WR EE-SX675-C1J-R/675P-C1J-R

Terminal Arrangement

Brown	(1)	Vcc
Pink	(2)	L
Blue	(3)	GND(0V)
Black	(4)	OUTPUT

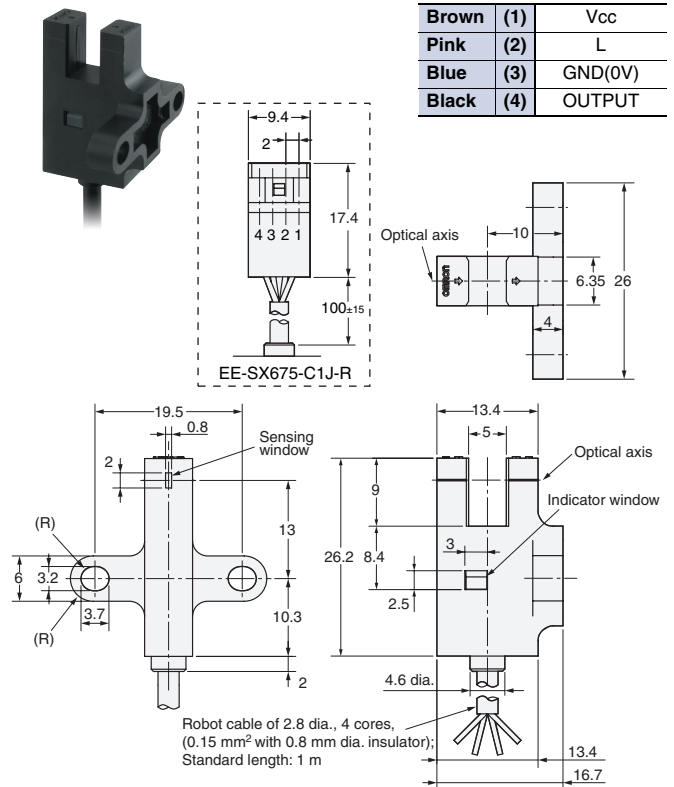

EE-SX676-WR/676P-WR EE-SX676-C1J-R/676P-C1J-R

Terminal Arrangement

Brown	(1)	Vcc
Pink	(2)	L
Blue	(3)	GND(0V)
Black	(4)	OUTPUT

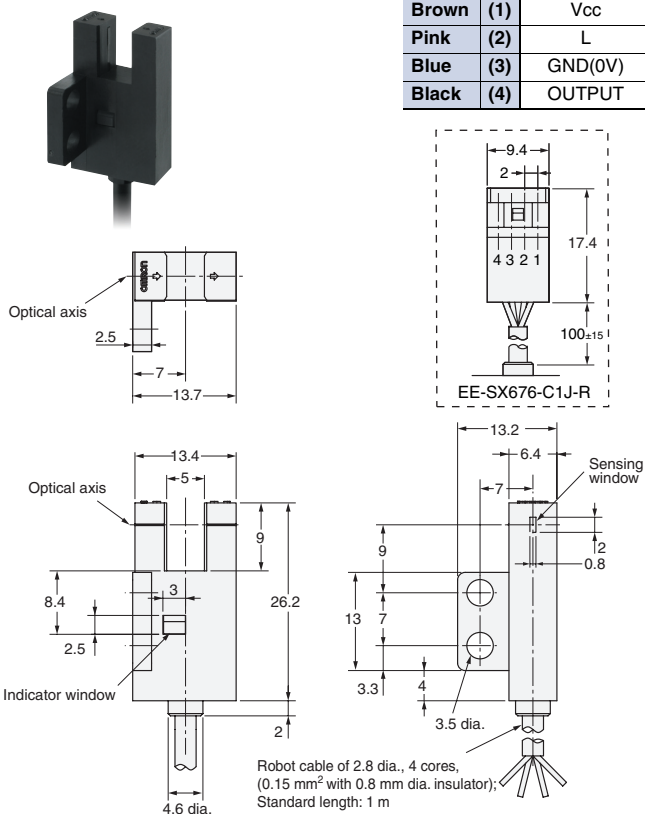

EE-SX677-WR/677P-WR EE-SX677-C1J-R/677P-C1J-R

Terminal Arrangement

Brown	(1)	Vcc
Pink	(2)	L
Blue	(3)	GND(0V)
Black	(4)	OUTPUT

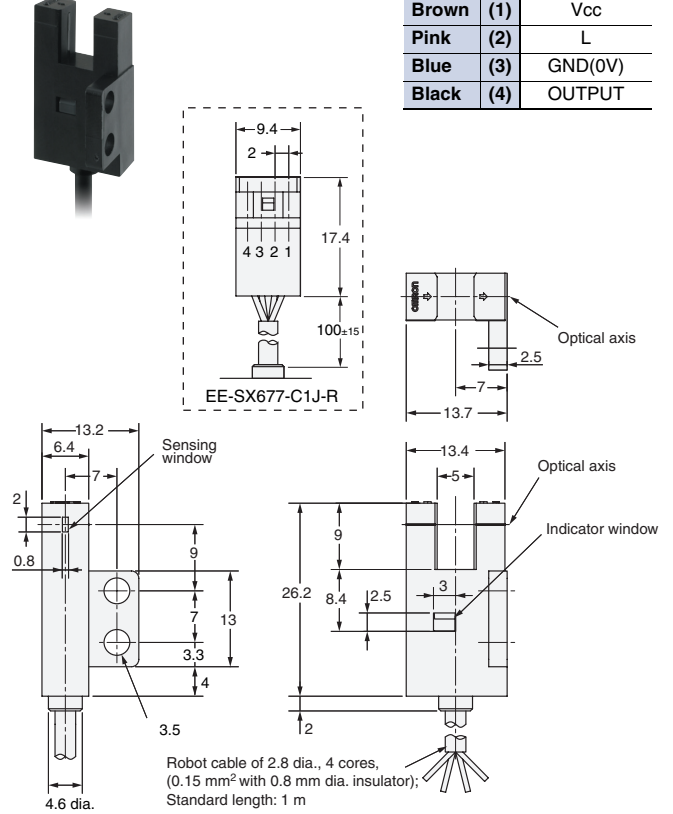

Accessories (Order Separately)
Connector for the EE-SX67 with Junction Connector

EE-1016-R-1

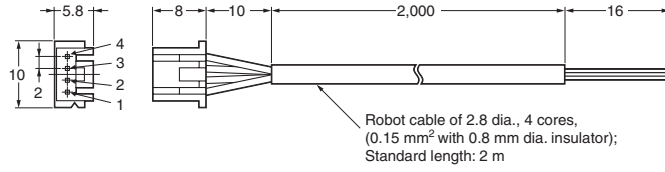

Terminal Arrangement

(1)	⊕	Brown
(2)	L	Pink
(3)	⊖	Blue
(4)	OUT	Black

* Refer to *Accessories* for details.

Read and Understand This Catalog

Please read and understand this catalog before purchasing the products. Please consult your OMRON representative if you have any questions or comments.

Warranty and Limitations of Liability

WARRANTY

OMRON's exclusive warranty is that the products are free from defects in materials and workmanship for a period of one year (or other period if specified) from date of sale by OMRON.

OMRON MAKES NO WARRANTY OR REPRESENTATION, EXPRESS OR IMPLIED, REGARDING NON-INFRINGEMENT, MERCHANTABILITY, OR FITNESS FOR PARTICULAR PURPOSE OF THE PRODUCTS. ANY BUYER OR USER ACKNOWLEDGES THAT THE BUYER OR USER ALONE HAS DETERMINED THAT THE PRODUCTS WILL SUITABLY MEET THE REQUIREMENTS OF THEIR INTENDED USE. OMRON DISCLAIMS ALL OTHER WARRANTIES, EXPRESS OR IMPLIED.

LIMITATIONS OF LIABILITY

OMRON SHALL NOT BE RESPONSIBLE FOR SPECIAL, INDIRECT, OR CONSEQUENTIAL DAMAGES, LOSS OF PROFITS OR COMMERCIAL LOSS IN ANY WAY CONNECTED WITH THE PRODUCTS, WHETHER SUCH CLAIM IS BASED ON CONTRACT, WARRANTY, NEGLIGENCE, OR STRICT LIABILITY.

In no event shall the responsibility of OMRON for any act exceed the individual price of the product on which liability is asserted.

IN NO EVENT SHALL OMRON BE RESPONSIBLE FOR WARRANTY, REPAIR, OR OTHER CLAIMS REGARDING THE PRODUCTS UNLESS OMRON'S ANALYSIS CONFIRMS THAT THE PRODUCTS WERE PROPERLY HANDLED, STORED, INSTALLED, AND MAINTAINED AND NOT SUBJECT TO CONTAMINATION, ABUSE, MISUSE, OR INAPPROPRIATE MODIFICATION OR REPAIR.

Application Considerations

SUITABILITY FOR USE

OMRON shall not be responsible for conformity with any standards, codes, or regulations that apply to the combination of products in the customer's application or use of the products.

At the customer's request, OMRON will provide applicable third party certification documents identifying ratings and limitations of use that apply to the products. This information by itself is not sufficient for a complete determination of the suitability of the products in combination with the end product, machine, system, or other application or use.

The following are some examples of applications for which particular attention must be given. This is not intended to be an exhaustive list of all possible uses of the products, nor is it intended to imply that the uses listed may be suitable for the products:

- Outdoor use, uses involving potential chemical contamination or electrical interference, or conditions or uses not described in this catalog.
- Nuclear energy control systems, combustion systems, railroad systems, aviation systems, medical equipment, amusement machines, vehicles, safety equipment, and installations subject to separate industry or government regulations.
- Systems, machines, and equipment that could present a risk to life or property.

Please know and observe all prohibitions of use applicable to the products.

NEVER USE THE PRODUCTS FOR AN APPLICATION INVOLVING SERIOUS RISK TO LIFE OR PROPERTY WITHOUT ENSURING THAT THE SYSTEM AS A WHOLE HAS BEEN DESIGNED TO ADDRESS THE RISKS, AND THAT THE OMRON PRODUCTS ARE PROPERLY RATED AND INSTALLED FOR THE INTENDED USE WITHIN THE OVERALL EQUIPMENT OR SYSTEM.

PROGRAMMABLE PRODUCTS

OMRON shall not be responsible for the user's programming of a programmable product, or any consequence thereof.

Disclaimers

CHANGE IN SPECIFICATIONS

Product specifications and accessories may be changed at any time based on improvements and other reasons.

It is our practice to change model numbers when published ratings or features are changed, or when significant construction changes are made. However, some specifications of the products may be changed without any notice. When in doubt, special model numbers may be assigned to fix or establish key specifications for your application on your request. Please consult with your OMRON representative at any time to confirm actual specifications of purchased products.

DIMENSIONS AND WEIGHTS

Dimensions and weights are nominal and are not to be used for manufacturing purposes, even when tolerances are shown.

PERFORMANCE DATA

Performance data given in this catalog is provided as a guide for the user in determining suitability and does not constitute a warranty. It may represent the result of OMRON's test conditions, and the users must correlate it to actual application requirements. Actual performance is subject to the OMRON Warranty and Limitations of Liability.

ERRORS AND OMISSIONS

The information in this document has been carefully checked and is believed to be accurate; however, no responsibility is assumed for clerical, typographical, or proofreading errors, or omissions.

2008.11

In the interest of product improvement, specifications are subject to change without notice.

OMRON Corporation
Industrial Automation Company

<http://www.ia.omron.com/>

(c)Copyright OMRON Corporation 2008 All Right Reserved.



**Стандарт
Электрон
Связь**

Мы молодая и активно развивающаяся компания в области поставок электронных компонентов. Мы поставляем электронные компоненты отечественного и импортного производства напрямую от производителей и с крупнейших складов мира.

Благодаря сотрудничеству с мировыми поставщиками мы осуществляем комплексные и плановые поставки широчайшего спектра электронных компонентов.

Собственная эффективная логистика и склад в обеспечивает надежную поставку продукции в точно указанные сроки по всей России.

Мы осуществляем техническую поддержку нашим клиентам и предпродажную проверку качества продукции. На все поставляемые продукты мы предоставляем гарантию .

Осуществляем поставки продукции под контролем ВП МО РФ на предприятия военно-промышленного комплекса России , а также работаем в рамках 275 ФЗ с открытием отдельных счетов в уполномоченном банке. Система менеджмента качества компании соответствует требованиям ГОСТ ISO 9001.

Минимальные сроки поставки, гибкие цены, неограниченный ассортимент и индивидуальный подход к клиентам являются основой для выстраивания долгосрочного и эффективного сотрудничества с предприятиями радиоэлектронной промышленности, предприятиями ВПК и научно-исследовательскими институтами России.

С нами вы становитесь еще успешнее!

Наши контакты:

Телефон: +7 812 627 14 35

Электронная почта: sales@st-electron.ru

Адрес: 198099, Санкт-Петербург,
Промышленная ул, дом № 19, литера Н,
помещение 100-Н Офис 331