

## Photomicrosensor with 50- to 100-mA direct switching capacity for built-in application.

- Series includes models that enable switching between dark-ON and light-ON operation.
- Response frequency as high as 1 kHz.
- Easy operation monitoring with bright light indicator.
- Wide operating voltage range: 5 to 24 VDC
- Models in which the light indicator turns ON for dark-ON operation are also available.
- A wide range of variations in eight different shapes.
- Flexible robot cable is provided as a standard feature. \*2

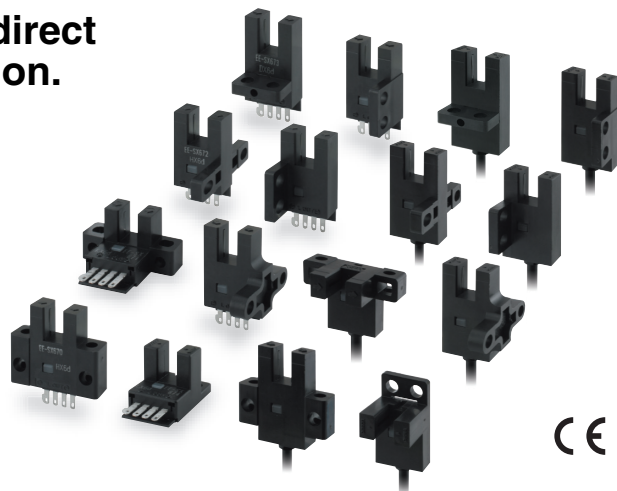

Be sure to read *Safety Precautions* on page 5.









\*1. Pre-wired Models are available only in the EE-SX67 Series.

\*2. Only for Pre-wired Models and Pre-wired Connector Models.

## Ordering Information

### Connector









 Infrared light

| Appearance   | Sensing method                | Connect-ing method  | Sensing distance  | Output configuration             | Indicator mode                   | Model          |            |
|--|-------------------------------|---------------------|---|----------------------------------|----------------------------------|----------------|------------|
|  |                               |                     |   |                                  |                                  | NPN output     | PNP output |
| Standard<br>                     | Through-beam type (with slot) | Connector (4 poles) |  5 mm (slot width) | Dark-ON/Light-ON (selectable) *3 | Incident light                   | EE-SX670       | EE-SX670P  |
|  |                               |                     |   |                                  | No incident light                | EE-SX670A      | EE-SX670R  |
| L-shaped<br>                    |                               |                     |   | Light-ON                         | Incident light                   | EE-SX470       | EE-SX470P  |
|  |                               |                     |   |                                  | Dark-ON/Light-ON (selectable) *3 | Incident light | EE-SX671   |
| T-shaped, slot center 7 mm<br>  |                               |                     |   | Light-ON                         | No incident light                | EE-SX671A      | EE-SX671R  |
|  |                               |                     |   |                                  | Dark-ON/Light-ON (selectable) *3 | Incident light | EE-SX672   |
| Close-mounting<br>              |                               |                     |   | Light-ON                         | No incident light                | EE-SX672A      | EE-SX672R  |
|  |                               |                     |   |                                  | Dark-ON/Light-ON (selectable) *3 | Incident light | EE-SX673   |
| Close-mounting<br>              |                               |                     |   | Light-ON                         | No incident light                | EE-SX673A      | EE-SX673R  |
|  |                               |                     |   |                                  | Dark-ON/Light-ON (selectable) *3 | Incident light | EE-SX473   |
| T-shaped, slot center 10 mm<br> |                               |                     |   | Light-ON                         | No incident light                | EE-SX473A      | EE-SX473P  |
|  |                               |                     |   |                                  | Dark-ON/Light-ON (selectable) *3 | Incident light | EE-SX674   |
| F-shaped<br>                    |                               |                     |   | Light-ON                         | No incident light                | EE-SX674A      | EE-SX674R  |
|  |                               |                     |   |                                  | Dark-ON/Light-ON (selectable) *3 | Incident light | EE-SX474   |
| R-shaped<br>                    |                               |                     |   | Light-ON                         | No incident light                | EE-SX474A      | EE-SX474P  |
|  |                               |                     |   |                                  | Dark-ON/Light-ON (selectable) *3 | Incident light | EE-SX675   |
|  |                               |                     |   | Dark-ON/Light-ON (selectable) *3 | Incident light                   | EE-SX676       | EE-SX676P  |
|  |                               |                     |   | Dark-ON/Light-ON (selectable) *3 | Incident light                   | EE-SX677       | EE-SX677P  |

\*3. Dark-ON when the L terminal of the connector is opened, and light-ON when the L terminal and positive (+) terminal are connected. Do not connect the L terminal to 0 V when using dark-ON operation. When using light-ON, it is useful to select the connector EE-1001-1. The L terminal and positive (+) terminal of this connector are connected in advance.

## Pre-wired Models, Models with Connectors

Infrared light

| Appearance   | Sensing method                | Sensing distance              |                      | Output configuration                | Indicator mode | Connecting method             | Model               |                      |
|--|-------------------------------|-------------------------------|----------------------|-------------------------------------|----------------|-------------------------------|---------------------|----------------------|
|  |                               |                               |                      |                                     |                |                               | NPN output          | PNP output           |
| Standard<br>                    | Through-beam type (with slot) |                               |                      | Dark-ON/<br>Light-ON (selectable) * | Incident light | Pre-wired Models (1m)         | EE-SX670-WR 1M      | EE-SX670P-WR 1M      |
|  |                               |                               |                      |                                     |                | Models with connectors (0.1m) | EE-SX670-C1J-R 0.1M | EE-SX670P-C1J-R 0.1M |
| L-shaped<br>                    |                               | Pre-wired Models (1m)         | EE-SX671-WR 1M       |                                     |                | EE-SX671P-WR 1M               |                     |                      |
|  |                               | Models with connectors (0.1m) | EE-SX671-C1J-R 0.1M  |                                     |                | EE-SX671P-C1J-R 0.1M          |                     |                      |
| T-shaped, slot center 7 mm<br>  |                               | Pre-wired Models (1m)         | EE-SX672-WR 1M       |                                     |                | EE-SX672P-WR 1M               |                     |                      |
|  |                               | Models with connectors (0.1m) | EE-SX672-C1J-R 0.1M  |                                     |                | EE-SX672P-C1J-R 0.1M          |                     |                      |
| Close-mounting<br>              |                               | Pre-wired Models (1m)         | EE-SX673-WR 1M       |                                     |                | EE-SX673P-WR 1M               |                     |                      |
|  |                               | Models with connectors (0.1m) | EE-SX673-C1J-R 0.1M  |                                     |                | EE-SX673P-C1J-R 0.1M          |                     |                      |
| Close-mounting<br>              |                               | Pre-wired Models (1m)         | EE-SX674-WR 1M       |                                     |                | EE-SX674P-WR 1M               |                     |                      |
|  |                               | Models with connectors (0.1m) | EE-SX674-C1J-R 0.1M  |                                     |                | EE-SX674P-C1J-R 0.1M          |                     |                      |
| T-shaped, slot center 10 mm<br> |                               | Pre-wired Models (1m)         | EE-SX675-WR 1M       |                                     |                | EE-SX675P-WR 1M               |                     |                      |
|  |                               | Models with connectors (0.1m) | EE-SX675-C1J-R 0.1M  |                                     |                | EE-SX675P-C1J-R 0.1M          |                     |                      |
| F-shaped<br>                   |                               | Pre-wired Models (1m)         | EE-SX676-WR 1M       |                                     |                | EE-SX676P-WR 1M               |                     |                      |
|  |                               | Models with connectors (0.1m) | EE-SX676-C1J-R 0.1M  |                                     |                | EE-SX676P-C1J-R 0.1M          |                     |                      |
| R-shaped<br>                  | Pre-wired Models (1m)         | EE-SX677-WR 1M                | EE-SX677P-WR 1M      |                                     |                |                               |                     |                      |
|  | Models with connectors (0.1m) | EE-SX677-C1J-R 0.1M           | EE-SX677P-C1J-R 0.1M |                                     |                |                               |                     |                      |

\* Dark-ON operation can be used when the L terminal is left unconnected or Light-ON operation can be used when the L terminal and positive (+) terminal are connected to each other. Do not connect the L terminal to 0 V when using dark-ON operation.

## Accessories (Order Separately) Connector Models

| Type                       | Cable length | Model     | Remarks   |
|----------------------------|--------------|-----------|---|
| Connector                  |              | EE-1001   |   |
|                            |              | EE-1001-1 | L terminal and positive (+) terminal are already short-circuited. |
|                            |              | EE-1009   |   |
| Connector with Cable       | 1 m          | EE-1006   |   |
|                            |              | EE-1010   |   |
|                            | 2 m          | EE-1006   |   |
|                            |              | EE-1010   |   |
| Connector with Robot Cable | 1 m          | EE-1010-R |   |
|                            | 2 m          | EE-1010-R |   |
| Connector Hold-down Clip   |              | EE-1006A  | For EE-1006 only.   |

\* Refer to *Accessories* for details.

## Accessories (Order Separately) Models with Connectors

| Type                       | Cable length | Model       | Remarks                  |
|----------------------------|--------------|-------------|--------------------------|
| Connector with Robot Cable | 2 m          | EE-1016-R-1 | For EE-SX67□-C1J-R only. |

## Ratings and Specifications

| Item                      | Type                   |  | Standard                            | L-shaped                            | T-shaped, slot center 7 mm          | Close-mounting                      |                                   | T-shaped, slot center 10 mm | F-shaped        | R-shaped |
|---------------------------|------------------------|--|-------------------------------------|-------------------------------------|-------------------------------------|-------------------------------------|-----------------------------------|-----------------------------|-----------------|----------|
|                           | NPN models             | Connector models   | EE-SX670<br>EE-SX670A<br>EE-SX470   | EE-SX671<br>EE-SX671A<br>EE-SX471   | EE-SX672<br>EE-SX672A<br>EE-SX472   | EE-SX673<br>EE-SX673A<br>EE-SX473   | EE-SX674<br>EE-SX674A<br>EE-SX474 | EE-SX675                    | EE-SX676        | EE-SX677 |
| Pre-wired models          |                        | EE-SX670-WR  | EE-SX671-WR                         | EE-SX672-WR                         | EE-SX673-WR                         | EE-SX674-WR                         | EE-SX675-WR                       | EE-SX676-WR                 | EE-SX677-WR     |          |
| Models with connectors    |                        | EE-SX670-CJ1-R   | EE-SX671-CJ1-R                      | EE-SX672-CJ1-R                      | EE-SX673-CJ1-R                      | EE-SX674-CJ1-R                      | EE-SX675-CJ1-R                    | EE-SX676-CJ1-R              | EE-SX677-CJ1-R  |          |
| PNP models                | Connector models       | EE-SX670P<br>EE-SX670R<br>EE-SX470P  | EE-SX671P<br>EE-SX671R<br>EE-SX471P | EE-SX672P<br>EE-SX672R<br>EE-SX472P | EE-SX673P<br>EE-SX673R<br>EE-SX473P | EE-SX674P<br>EE-SX674R<br>EE-SX474P | EE-SX675P                         | EE-SX676P                   | EE-SX677P       |          |
|                           | Pre-wired models       | EE-SX670P-WR   | EE-SX671P-WR                        | EE-SX672P-WR                        | EE-SX673P-WR                        | EE-SX674P-WR                        | EE-SX675P-WR                      | EE-SX676P-WR                | EE-SX677P-WR    |          |
|                           | Models with connectors | EE-SX670P-CJ1-R  | EE-SX671P-CJ1-R                     | EE-SX672P-CJ1-R                     | EE-SX673P-CJ1-R                     | EE-SX674P-CJ1-R                     | EE-SX675P-CJ1-R                   | EE-SX676P-CJ1-R             | EE-SX677P-CJ1-R |          |
| Sensing distance          |                        | 5 mm (slot width)  |                                     |                                     |                                     |                                     |                                   |                             |                 |          |
| Sensing object            |                        | Opaque: 2 × 0.8 mm min.  |                                     |                                     |                                     |                                     |                                   |                             |                 |          |
| Differential distance     |                        | 0.025 mm   |                                     |                                     |                                     |                                     |                                   |                             |                 |          |
| Light source              |                        | GaAs infrared LED with a peak wavelength of 940 nm   |                                     |                                     |                                     |                                     |                                   |                             |                 |          |
| Indicator *1              |                        | Light indicator (red) (turns ON when light is interrupted for models with A or R suffix)   |                                     |                                     |                                     |                                     |                                   |                             |                 |          |
| Supply voltage            |                        | 5 to 24 VDC ±10%, ripple (p-p): 10% max.   |                                     |                                     |                                     |                                     |                                   |                             |                 |          |
| Current consumption       |                        | 35 mA max. (NPN models), 30 mA max. (PNP models)   |                                     |                                     |                                     |                                     |                                   |                             |                 |          |
| Control output            |                        | NPN open collector: 5 to 24 VDC, 100 mA max.<br>100 mA load current with a residual voltage of 0.8 V max.<br>40 mA load current with a residual voltage of 0.4 V max.<br>OFF current: 0.5 mA max.<br>PNP open collector: 5 to 24 VDC, 50 mA max.<br>50 mA load current with a residual voltage of 1.3 V max.<br>OFF current: 0.5 mA max. |                                     |                                     |                                     |                                     |                                   |                             |                 |          |
| Response frequency *2     |                        | 1 kHz min. (3 kHz average)   |                                     |                                     |                                     |                                     |                                   |                             |                 |          |
| Ambient illumination      |                        | 1,000 lx max. with fluorescent light on the surface of the receiver.   |                                     |                                     |                                     |                                     |                                   |                             |                 |          |
| Ambient temperature range |                        | Operating: -25 to +55°C, Storage: -30 to +80°C (with no icing or condensation)   |                                     |                                     |                                     |                                     |                                   |                             |                 |          |
| Ambient humidity range    |                        | Operating: 5% to 85%, Storage: 5% to 95% (with no icing or condensation)   |                                     |                                     |                                     |                                     |                                   |                             |                 |          |
| Vibration resistance      |                        | Destruction: 20 to 2,000 Hz (peak acceleration: 100 m/s <sup>2</sup> )<br>1.5-mm double amplitude for 2 h (4-min periods) each in X, Y, and Z directions   |                                     |                                     |                                     |                                     |                                   |                             |                 |          |
| Shock resistance          |                        | Destruction: 500 m/s <sup>2</sup> for 3 times each in X, Y, and Z directions   |                                     |                                     |                                     |                                     |                                   |                             |                 |          |
| Degree of protection      |                        | IEC60529 IP50  |                                     |                                     |                                     |                                     |                                   |                             |                 |          |
| Connecting method         |                        | Connector Models (direct soldering possible), Pre-wired Models (Standard cable length: 1 m), Models with Connectors (Standard cable length: 0.1 m)   |                                     |                                     |                                     |                                     |                                   |                             |                 |          |
| Weight                    | Connector models       | Approx. 3.1 g  | Approx. 3 g                         | Approx. 2.4 g                       | Approx. 2.3 g                       | Approx. 3 g                         | Approx. 2.7 g                     | Approx. 2.2 g               | Approx. 2.2 g   |          |
|                           | Pre-wired models       | Approx. 18.9 g   | Approx. 17.3 g                      | Approx. 17.8 g                      | Approx. 16.8 g                      | Approx. 17.1 g                      | Approx. 18.3 g                    | Approx. 16.9 g              | Approx. 16.9 g  |          |
|                           | Models with connectors | Approx. 6.3 g  | Approx. 4.7 g                       | Approx. 5.2 g                       | Approx. 4.2 g                       | Approx. 4.5 g                       | Approx. 5.7 g                     | Approx. 4.3 g               | Approx. 4.3 g   |          |
| Material                  | Case                   | Polybutylene phthalate (PBT)   |                                     |                                     |                                     |                                     |                                   |                             |                 |          |
|                           | Cover                  | Polycarbonate  |                                     |                                     |                                     |                                     |                                   |                             |                 |          |
|                           | Emitter/receiver       | Polycarbonate  |                                     |                                     |                                     |                                     |                                   |                             |                 |          |

\*1. The indicator is a GaP red LED (peak wavelength: 690 nm).

\*2. The response frequency was measured by detecting the rotating disk shown at the right.

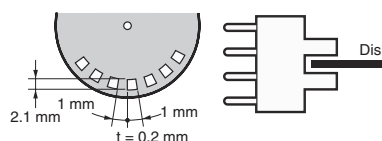

### Connector for the EE-SX67 with Junction Connector

| Product Model                               | Connector with Robot Cable              |                 |
|---|---|-----------------|
| EE-1016-R-1                                 |   |                 |
| Appearance                                  |   |                 |
| Item  |   |                 |
| Contact resistance                          | 25 mΩ max. (at 10 mA DC and 20 mV max.) |                 |
| Insertion strength                          | 20 N max.                               |                 |
| Surplus strength (housing holding strength) | 15 N min.                               |                 |
| Cable length                                | 2 m                                     |                 |
| Ambient temperature range                   | -25 to +85°C                            |                 |
| Materials                                   | Housing                                 | Nylon           |
|   | Contact                                 | Phosphor bronze |

Engineering Data (Typical)

Sensing Position Characteristics

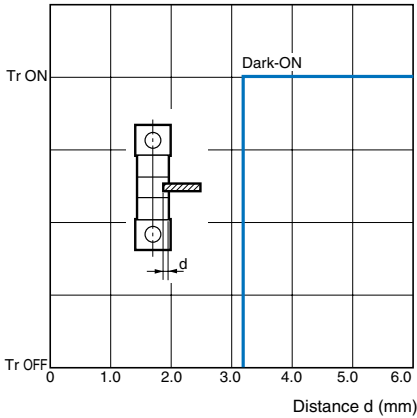

Sensing Position Characteristics

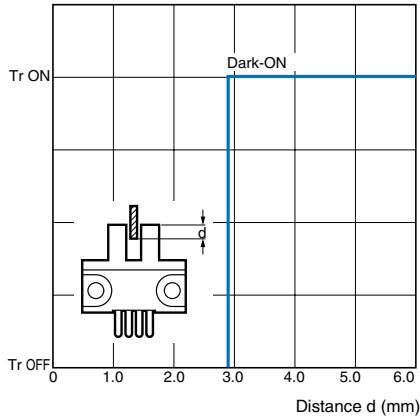

Repeated Sensing Position Characteristics

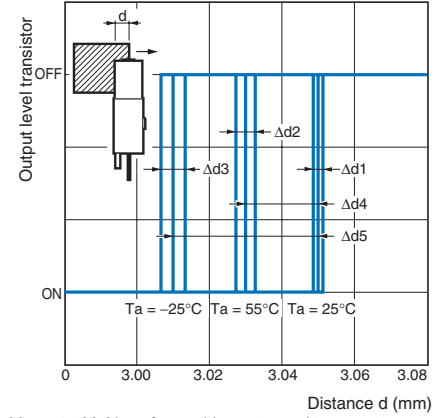

Vcc = 12 V, No. of repetitions: 20, Δd1 = 0.002 mm, Δd2 = 0.004 mm, Δd3 = 0.005 mm, Δd4 = 0.02 mm, Δd5 = 0.04 mm

Note: The data applies to dark status. Operation may be affected by external light interference or light coming through the sensing object.

I/O Circuit Diagrams

NPN Output

| Model   | Output configuration | Timing charts  | Terminal connections                                       | Output circuit |
|---|----------------------|--|--|----------------|
| EE-SX67□<br>EE-SX67□-WR<br>EE-SX67□-CJ1-R                     | Light-ON             | Incident Interrupted<br>Light indicator (red) ON OFF<br>Output transistor ON OFF<br>Load 1 Operates (e.g., relay) Releases<br>Load 2 H L | Short-circuited between ⊖ terminal and positive ⊕ terminal |                |
|   | Dark-ON              | Incident Interrupted<br>Light indicator (red) ON OFF<br>Output transistor ON OFF<br>Load 1 Operates (e.g., relay) Releases<br>Load 2 H L | Open between ⊖ terminal and positive ⊕ terminal *1         |                |
| EE-SX670A<br>EE-SX671A<br>EE-SX672A<br>EE-SX673A<br>EE-SX674A | Light-ON             | Incident Interrupted<br>Light indicator (red) ON OFF<br>Output transistor ON OFF<br>Load 1 Operates (e.g., relay) Releases<br>Load 2 H L | Short-circuited between ⊖ terminal and positive ⊕ terminal |                |
|   | Dark-ON              | Incident Interrupted<br>Light indicator (red) ON OFF<br>Output transistor ON OFF<br>Load 1 Operates (e.g., relay) Releases<br>Load 2 H L | Open between ⊖ terminal and positive ⊕ terminal *1         |                |
| EE-SX470<br>EE-SX471<br>EE-SX472<br>EE-SX473<br>EE-SX474      | Light-ON             | Incident Interrupted<br>Light indicator (red) ON OFF<br>Output transistor ON OFF<br>Load 1 (relay) Operates Releases<br>Load 2 H L       | ---  |                |

\*1. Do not connect the L terminal to 0 V when using dark-ON operation.

PNP Output

| Model   | Output configuration | Timing charts  | Terminal connections                                       | Output circuit   |
|---|----------------------|--|--|--|
| EE-SX67□P<br>EE-SX67□P-WR<br>EE-SX67□P-CJ1-R                  | Light-ON             | Incident Interrupted<br>Light indicator (red) ON OFF<br>Output transistor ON OFF<br>Load (relay) Operates Releases       | Short-circuited between ⊖ terminal and positive ⊕ terminal | <p>*The terminal arrangement depends on the model. Check the dimensional diagrams.</p> |
|   | Dark-ON              | Incident Interrupted<br>Light indicator (red) ON OFF<br>Output transistor ON OFF<br>Load (relay) Operates Releases       | Open between ⊖ terminal and positive ⊕ terminal *1         |  |
| EE-SX670R<br>EE-SX671R<br>EE-SX672R<br>EE-SX673R<br>EE-SX674R | Light-ON             | Incident Interrupted<br>Light indicator (red) ON OFF<br>Output transistor ON OFF<br>Load (e.g., relay) Operates Releases | Short-circuited between ⊖ terminal and positive ⊕ terminal |  |
|   | Dark-ON              | Incident Interrupted<br>Light indicator (red) ON OFF<br>Output transistor ON OFF<br>Load (e.g., relay) Operates Releases | Open between ⊖ terminal and positive ⊕ terminal *1         |  |
| EE-SX470P<br>EE-SX471P<br>EE-SX472P<br>EE-SX473P<br>EE-SX474P | Light-ON             | Incident Interrupted<br>Light indicator (red) ON OFF<br>Output transistor ON OFF<br>Load (relay) Operates Releases       | ---  |  |

\*1. Do not connect the L terminal to 0 V when using dark-ON operation.

Safety Precautions

Refer to *Warranty and Limitations of Liability*.

**WARNING**

This product is not designed or rated for ensuring safety of persons either directly or indirectly. Do not use it for such purposes.



**Precautions for Safe Use**

● Operating Environment

These Photomicrosensors have an IP50 (conforms to IEC) enclosure and do not have a water-proof or dust-proof structure. Therefore, do not use them in applications in which the sensor will be subjected to splashes from water, oil, or any other liquid. Liquid entering the Sensor may result in malfunction.

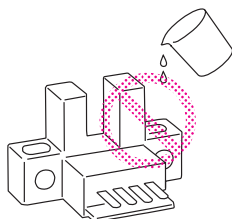

**Precautions for Correct Use**

Make sure that this product is used within the rated ambient environment conditions.

● Installation

- When direct soldering to the terminals, use the following guidelines.

Soldering Conditions

| Item           | Temperature | Permissible time | Remarks  |
|----------------|-------------|------------------|--|
| Soldering iron | 350°C max.  | 3 s max.         | The portion between the base of the terminals and the position 1.5 mm from the terminal base must not be soldered. |

- The terminal base uses a polycarbonate resin, which could be deformed by excessive soldering heat, resulting in damage to the product's functionality.

● Lot Number and Model Number Legend

In the following diagrams, 376d indicates the lot number and factory where the product was manufactured. Do not include this code with the model number when ordering.

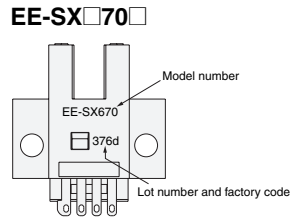

(Unit: mm)

## Dimensions

Tolerance class IT16 applies to dimensions in this datasheet unless otherwise specified.

### Sensors

EE-SX670/670P  
EE-SX670A/670R  
EE-SX470/470P

#### Terminal Arrangement

|     |     |           |
|-----|-----|-----------|
| (1) | ⊕   | Vcc       |
| (2) | L   | L*        |
| (3) | OUT | OUTPUT    |
| (4) | ⊖   | GND (0 V) |

\* Pin 2 is not used for the EE-SX470.

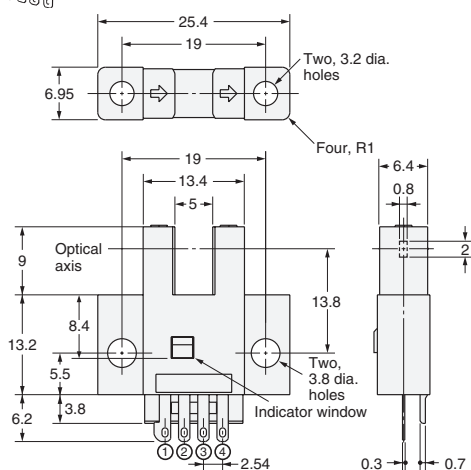
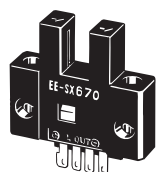

EE-SX671/671P  
EE-SX671A/671R  
EE-SX471/471P

#### Terminal Arrangement

|     |     |           |
|-----|-----|-----------|
| (1) | ⊕   | Vcc       |
| (2) | L   | L*        |
| (3) | OUT | OUTPUT    |
| (4) | ⊖   | GND (0 V) |

\* Pin 2 is not used for the EE-SX471.

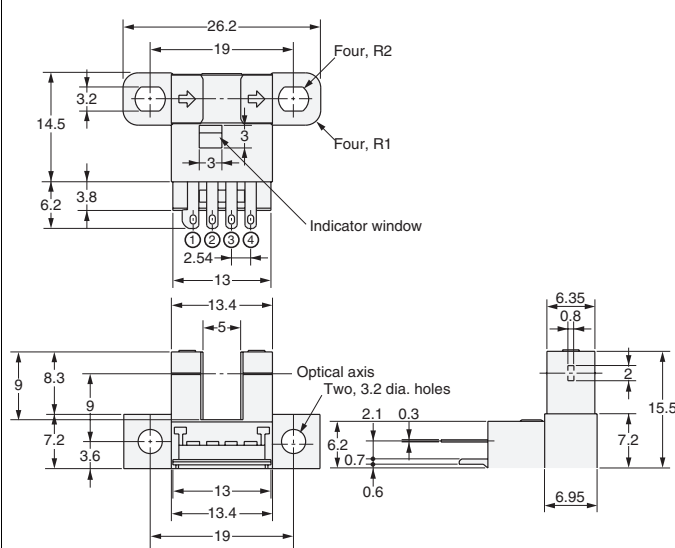
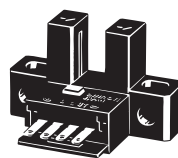

**EE-SX672/672P**  
**EE-SX672A/672R**  
**EE-SX472/472P**

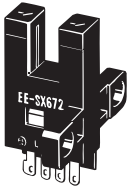

**Terminal Arrangement**

|     |     |           |
|-----|-----|-----------|
| (1) | ⊕   | Vcc       |
| (2) | L   | L*        |
| (3) | OUT | OUTPUT    |
| (4) | ⊖   | GND (0 V) |

\* Pin 2 is not used for the EE-SX472.

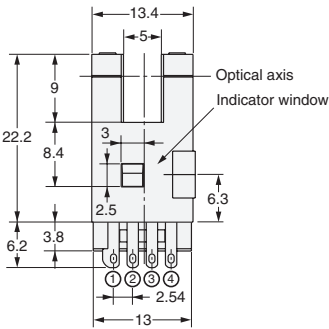
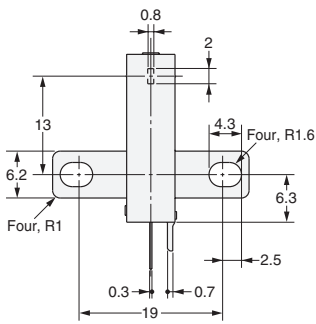
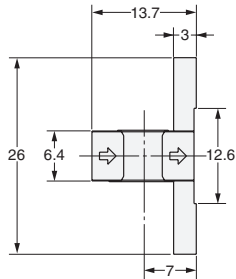

**EE-SX673/673P**  
**EE-SX673A/673R**  
**EE-SX473/473P**



**Terminal Arrangement**

|     |     |           |
|-----|-----|-----------|
| (1) | ⊕   | Vcc       |
| (2) | L   | L*        |
| (3) | OUT | OUTPUT    |
| (4) | ⊖   | GND (0 V) |

\* Pin 2 is not used for the EE-SX473.

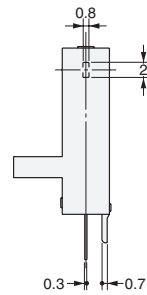
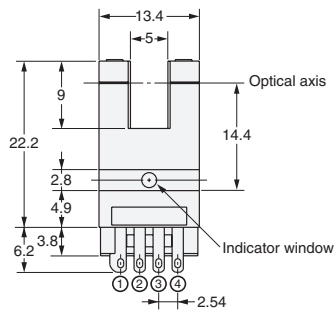
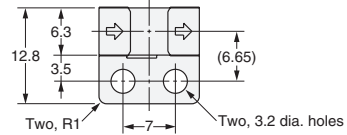



EE-SX674/674P  
EE-SX674A/674R  
EE-SX474/474P



Terminal Arrangement

|     |     |           |
|-----|-----|-----------|
| (1) | ⊕   | Vcc       |
| (2) | L   | L*        |
| (3) | OUT | OUTPUT    |
| (4) | ⊖   | GND (0 V) |

\* Pin 2 is not used for the EE-SX474.

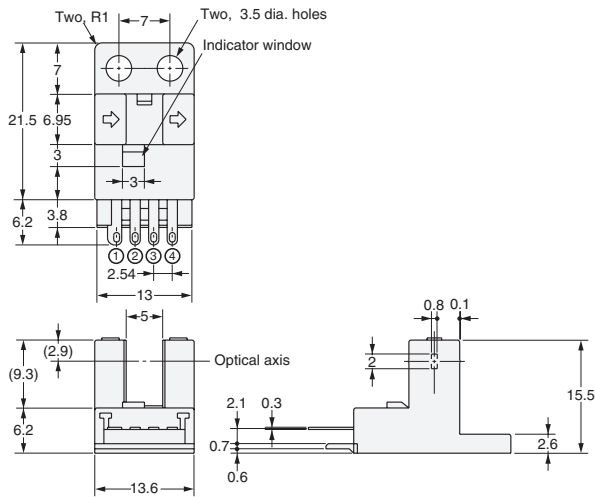

EE-SX675/675P



Terminal Arrangement

|     |     |           |
|-----|-----|-----------|
| (1) | ⊕   | Vcc       |
| (2) | L   | L         |
| (3) | OUT | OUTPUT    |
| (4) | ⊖   | GND (0 V) |

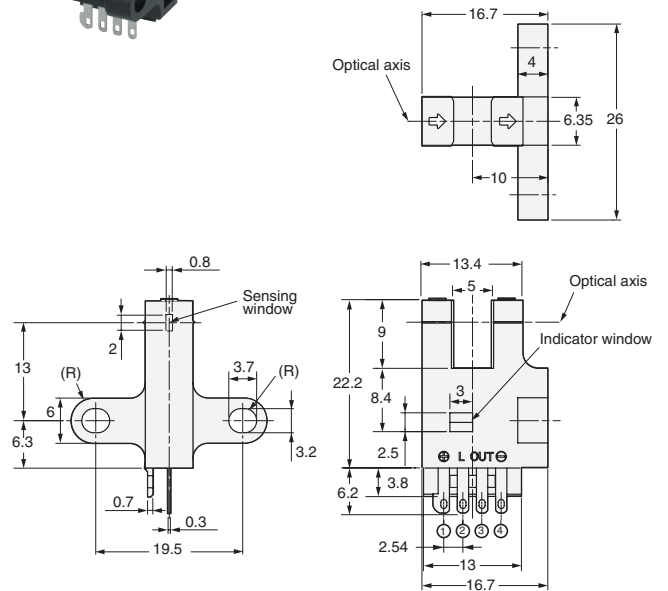

EE-SX676/676P



Terminal Arrangement

|     |     |           |
|-----|-----|-----------|
| (1) | ⊕   | Vcc       |
| (2) | L   | L         |
| (3) | OUT | OUTPUT    |
| (4) | ⊖   | GND (0 V) |

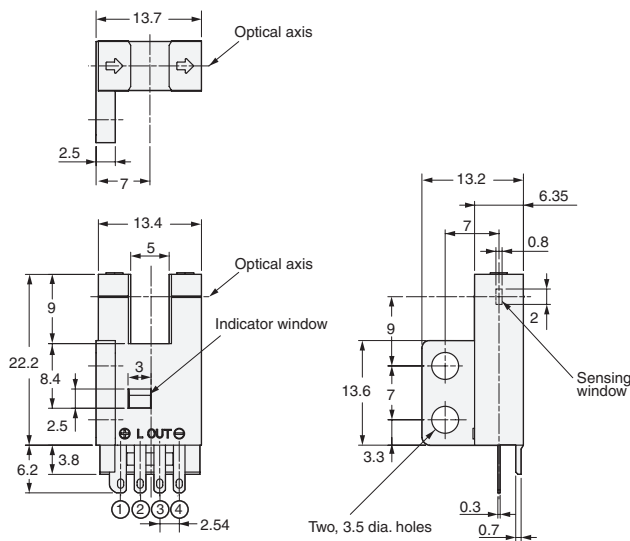

EE-SX677/677P



Terminal Arrangement

|     |     |           |
|-----|-----|-----------|
| (1) | ⊕   | Vcc       |
| (2) | L   | L         |
| (3) | OUT | OUTPUT    |
| (4) | ⊖   | GND (0 V) |

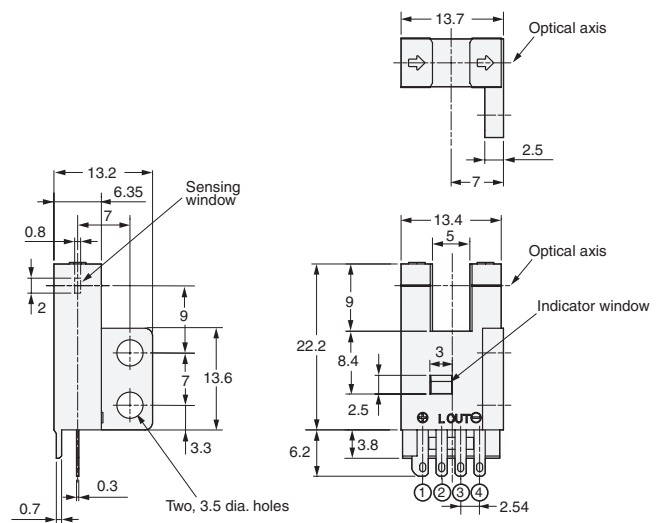

EE-SX670-WR/670P-WR  
EE-SX670-C1J-R/670P-C1J-R

Terminal Arrangement

|              |            |           |
|--------------|------------|-----------|
| <b>Brown</b> | <b>(1)</b> | Vcc       |
| <b>Pink</b>  | <b>(2)</b> | L         |
| <b>Blue</b>  | <b>(3)</b> | GND (0 V) |
| <b>Black</b> | <b>(4)</b> | OUTPUT    |

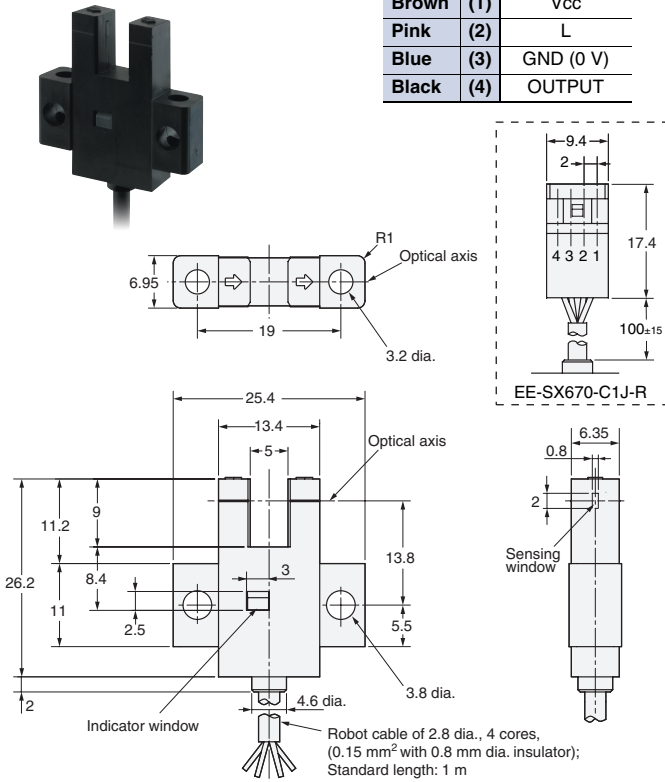

EE-SX671-WR/671P-WR  
EE-SX671-C1J-R/671P-C1J-R

Terminal Arrangement

|              |            |           |
|--------------|------------|-----------|
| <b>Brown</b> | <b>(1)</b> | Vcc       |
| <b>Pink</b>  | <b>(2)</b> | L         |
| <b>Blue</b>  | <b>(3)</b> | GND (0 V) |
| <b>Black</b> | <b>(4)</b> | OUTPUT    |

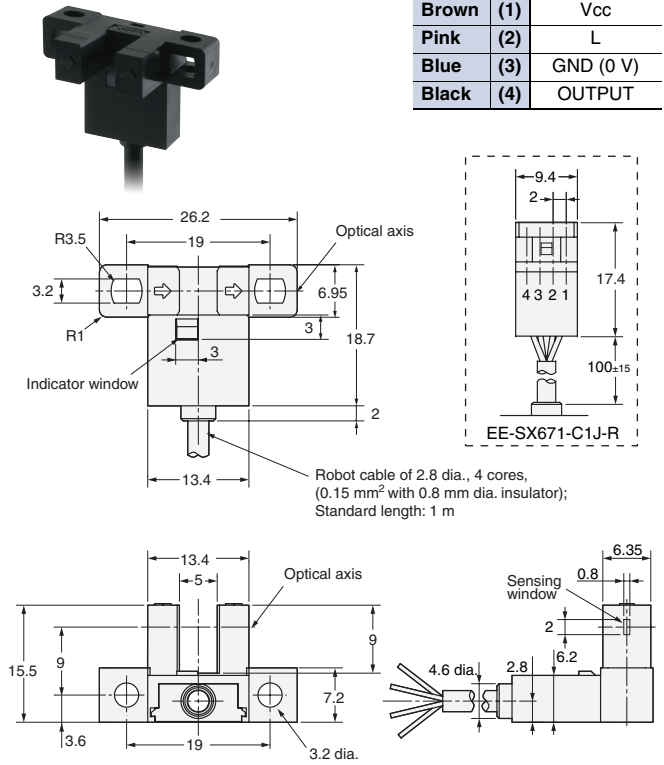

EE-SX672-WR/672P-WR  
EE-SX672-C1J-R/672P-C1J-R

Terminal Arrangement

|              |            |           |
|--------------|------------|-----------|
| <b>Brown</b> | <b>(1)</b> | Vcc       |
| <b>Pink</b>  | <b>(2)</b> | L         |
| <b>Blue</b>  | <b>(3)</b> | GND (0 V) |
| <b>Black</b> | <b>(4)</b> | OUTPUT    |

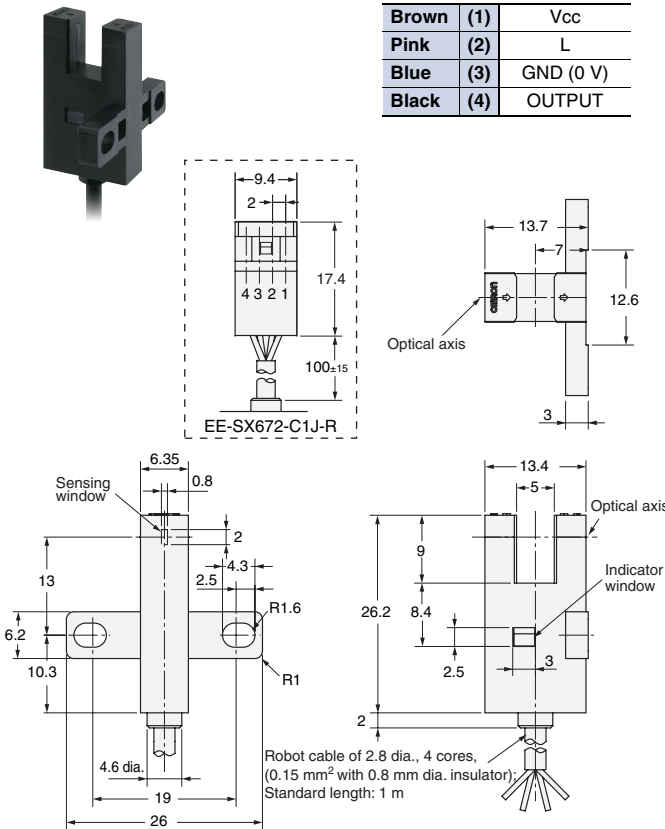

EE-SX673-WR/673P-WR  
EE-SX673-C1J-R/673P-C1J-R

Terminal Arrangement

|              |            |           |
|--------------|------------|-----------|
| <b>Brown</b> | <b>(1)</b> | Vcc       |
| <b>Pink</b>  | <b>(2)</b> | L         |
| <b>Blue</b>  | <b>(3)</b> | GND (0 V) |
| <b>Black</b> | <b>(4)</b> | OUTPUT    |

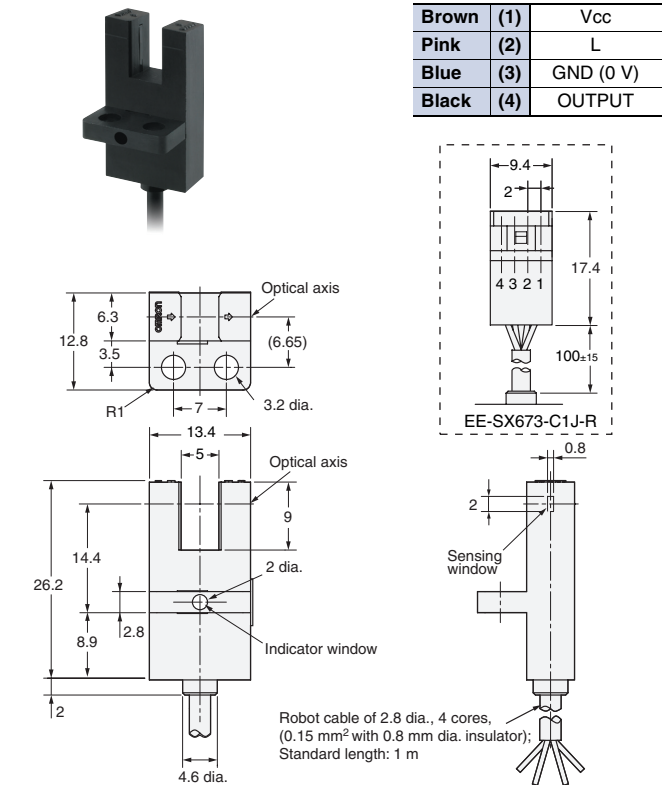

## EE-SX674-WR/674P-WR EE-SX674-C1J-R/674P-C1J-R

### Terminal Arrangement

|              |            |         |
|--------------|------------|---------|
| <b>Brown</b> | <b>(1)</b> | Vcc     |
| <b>Pink</b>  | <b>(2)</b> | L       |
| <b>Blue</b>  | <b>(3)</b> | GND(0V) |
| <b>Black</b> | <b>(4)</b> | OUTPUT  |

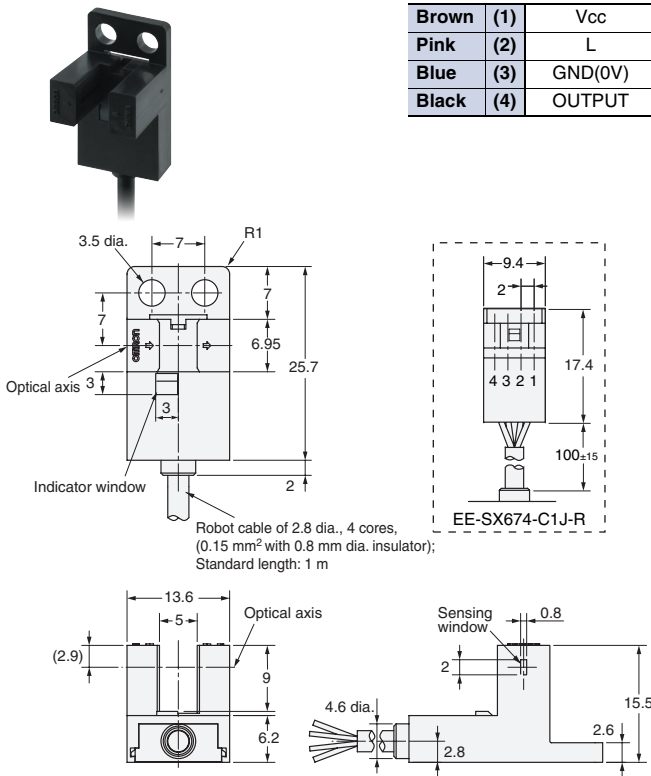

## EE-SX675-WR/675P-WR EE-SX675-C1J-R/675P-C1J-R

### Terminal Arrangement

|              |            |         |
|--------------|------------|---------|
| <b>Brown</b> | <b>(1)</b> | Vcc     |
| <b>Pink</b>  | <b>(2)</b> | L       |
| <b>Blue</b>  | <b>(3)</b> | GND(0V) |
| <b>Black</b> | <b>(4)</b> | OUTPUT  |

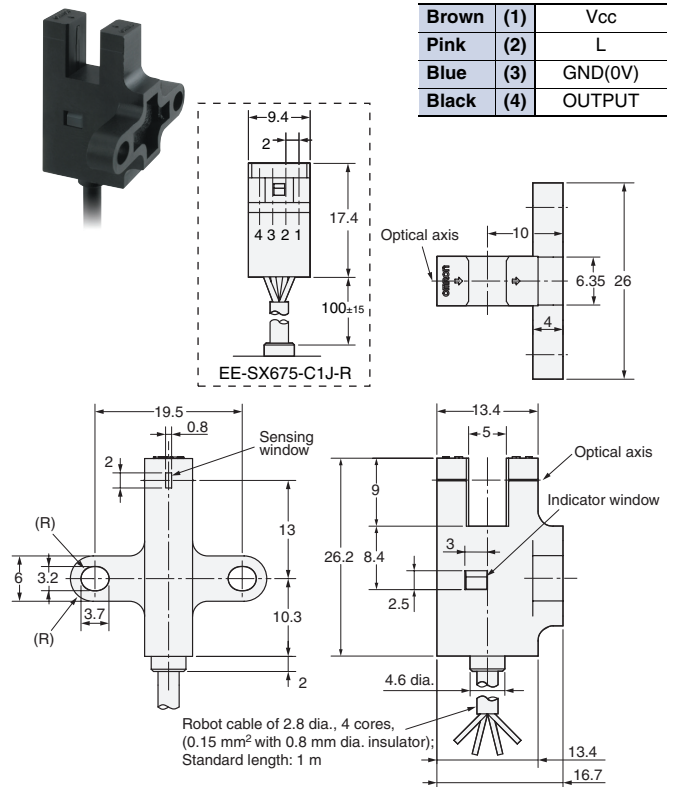

## EE-SX676-WR/676P-WR EE-SX676-C1J-R/676P-C1J-R

### Terminal Arrangement

|              |            |         |
|--------------|------------|---------|
| <b>Brown</b> | <b>(1)</b> | Vcc     |
| <b>Pink</b>  | <b>(2)</b> | L       |
| <b>Blue</b>  | <b>(3)</b> | GND(0V) |
| <b>Black</b> | <b>(4)</b> | OUTPUT  |

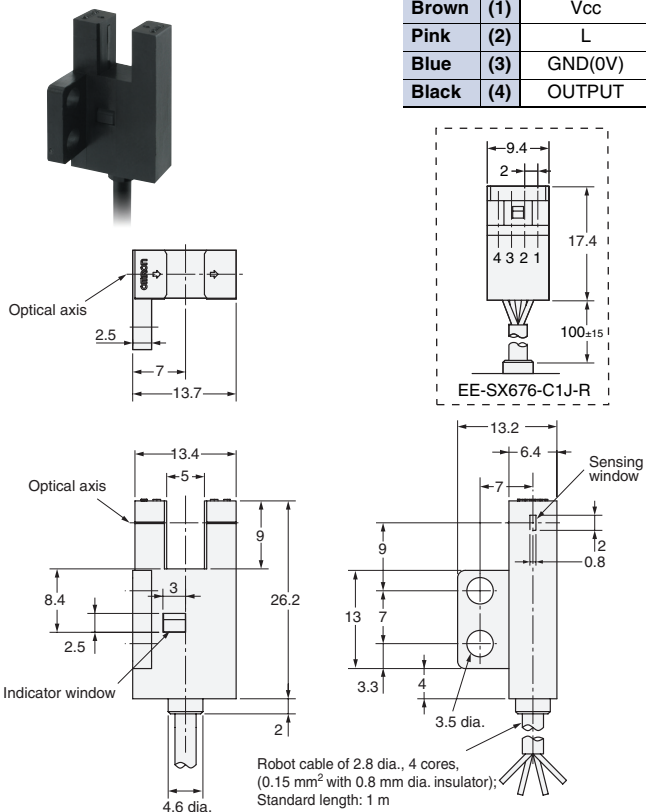

## EE-SX677-WR/677P-WR EE-SX677-C1J-R/677P-C1J-R

### Terminal Arrangement

|              |            |         |
|--------------|------------|---------|
| <b>Brown</b> | <b>(1)</b> | Vcc     |
| <b>Pink</b>  | <b>(2)</b> | L       |
| <b>Blue</b>  | <b>(3)</b> | GND(0V) |
| <b>Black</b> | <b>(4)</b> | OUTPUT  |

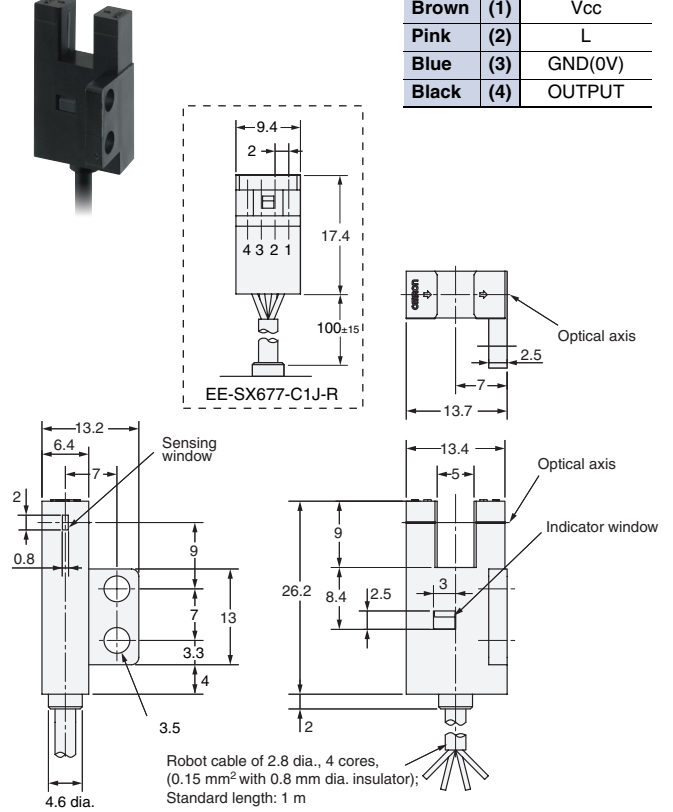

**Accessories (Order Separately)**  
Connector for the EE-SX67 with Junction Connector

EE-1016-R-1

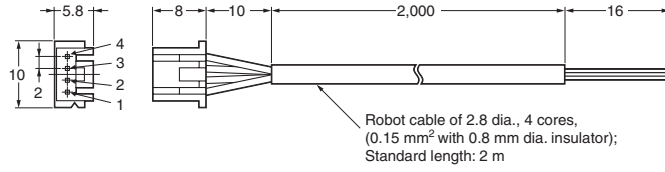

Terminal Arrangement

|     |     |       |
|-----|-----|-------|
| (1) | ⊕   | Brown |
| (2) | L   | Pink  |
| (3) | ⊖   | Blue  |
| (4) | OUT | Black |

\* Refer to *Accessories* for details.

## Read and Understand This Catalog

Please read and understand this catalog before purchasing the products. Please consult your OMRON representative if you have any questions or comments.

## Warranty and Limitations of Liability

### WARRANTY

OMRON's exclusive warranty is that the products are free from defects in materials and workmanship for a period of one year (or other period if specified) from date of sale by OMRON.

OMRON MAKES NO WARRANTY OR REPRESENTATION, EXPRESS OR IMPLIED, REGARDING NON-INFRINGEMENT, MERCHANTABILITY, OR FITNESS FOR PARTICULAR PURPOSE OF THE PRODUCTS. ANY BUYER OR USER ACKNOWLEDGES THAT THE BUYER OR USER ALONE HAS DETERMINED THAT THE PRODUCTS WILL SUITABLY MEET THE REQUIREMENTS OF THEIR INTENDED USE. OMRON DISCLAIMS ALL OTHER WARRANTIES, EXPRESS OR IMPLIED.

### LIMITATIONS OF LIABILITY

OMRON SHALL NOT BE RESPONSIBLE FOR SPECIAL, INDIRECT, OR CONSEQUENTIAL DAMAGES, LOSS OF PROFITS OR COMMERCIAL LOSS IN ANY WAY CONNECTED WITH THE PRODUCTS, WHETHER SUCH CLAIM IS BASED ON CONTRACT, WARRANTY, NEGLIGENCE, OR STRICT LIABILITY.

In no event shall the responsibility of OMRON for any act exceed the individual price of the product on which liability is asserted.

IN NO EVENT SHALL OMRON BE RESPONSIBLE FOR WARRANTY, REPAIR, OR OTHER CLAIMS REGARDING THE PRODUCTS UNLESS OMRON'S ANALYSIS CONFIRMS THAT THE PRODUCTS WERE PROPERLY HANDLED, STORED, INSTALLED, AND MAINTAINED AND NOT SUBJECT TO CONTAMINATION, ABUSE, MISUSE, OR INAPPROPRIATE MODIFICATION OR REPAIR.

## Application Considerations

### SUITABILITY FOR USE

OMRON shall not be responsible for conformity with any standards, codes, or regulations that apply to the combination of products in the customer's application or use of the products.

At the customer's request, OMRON will provide applicable third party certification documents identifying ratings and limitations of use that apply to the products. This information by itself is not sufficient for a complete determination of the suitability of the products in combination with the end product, machine, system, or other application or use.

The following are some examples of applications for which particular attention must be given. This is not intended to be an exhaustive list of all possible uses of the products, nor is it intended to imply that the uses listed may be suitable for the products:

- Outdoor use, uses involving potential chemical contamination or electrical interference, or conditions or uses not described in this catalog.
- Nuclear energy control systems, combustion systems, railroad systems, aviation systems, medical equipment, amusement machines, vehicles, safety equipment, and installations subject to separate industry or government regulations.
- Systems, machines, and equipment that could present a risk to life or property.

Please know and observe all prohibitions of use applicable to the products.

NEVER USE THE PRODUCTS FOR AN APPLICATION INVOLVING SERIOUS RISK TO LIFE OR PROPERTY WITHOUT ENSURING THAT THE SYSTEM AS A WHOLE HAS BEEN DESIGNED TO ADDRESS THE RISKS, AND THAT THE OMRON PRODUCTS ARE PROPERLY RATED AND INSTALLED FOR THE INTENDED USE WITHIN THE OVERALL EQUIPMENT OR SYSTEM.

### PROGRAMMABLE PRODUCTS

OMRON shall not be responsible for the user's programming of a programmable product, or any consequence thereof.

## Disclaimers

### CHANGE IN SPECIFICATIONS

Product specifications and accessories may be changed at any time based on improvements and other reasons.

It is our practice to change model numbers when published ratings or features are changed, or when significant construction changes are made. However, some specifications of the products may be changed without any notice. When in doubt, special model numbers may be assigned to fix or establish key specifications for your application on your request. Please consult with your OMRON representative at any time to confirm actual specifications of purchased products.

### DIMENSIONS AND WEIGHTS

Dimensions and weights are nominal and are not to be used for manufacturing purposes, even when tolerances are shown.

### PERFORMANCE DATA

Performance data given in this catalog is provided as a guide for the user in determining suitability and does not constitute a warranty. It may represent the result of OMRON's test conditions, and the users must correlate it to actual application requirements. Actual performance is subject to the OMRON Warranty and Limitations of Liability.

### ERRORS AND OMISSIONS

The information in this document has been carefully checked and is believed to be accurate; however, no responsibility is assumed for clerical, typographical, or proofreading errors, or omissions.

2008.11

In the interest of product improvement, specifications are subject to change without notice.

**OMRON Corporation**  
Industrial Automation Company

<http://www.ia.omron.com/>

(c)Copyright OMRON Corporation 2008 All Right Reserved.



## Стандарт Электрон Связь

Мы молодая и активно развивающаяся компания в области поставок электронных компонентов. Мы поставляем электронные компоненты отечественного и импортного производства напрямую от производителей и с крупнейших складов мира.

Благодаря сотрудничеству с мировыми поставщиками мы осуществляем комплексные и плановые поставки широчайшего спектра электронных компонентов.

Собственная эффективная логистика и склад в обеспечивает надежную поставку продукции в точно указанные сроки по всей России.

Мы осуществляем техническую поддержку нашим клиентам и предпродажную проверку качества продукции. На все поставляемые продукты мы предоставляем гарантию .

Осуществляем поставки продукции под контролем ВП МО РФ на предприятия военно-промышленного комплекса России , а также работаем в рамках 275 ФЗ с открытием отдельных счетов в уполномоченном банке. Система менеджмента качества компании соответствует требованиям ГОСТ ISO 9001.

Минимальные сроки поставки, гибкие цены, неограниченный ассортимент и индивидуальный подход к клиентам являются основой для выстраивания долгосрочного и эффективного сотрудничества с предприятиями радиоэлектронной промышленности, предприятиями ВПК и научно-исследовательскими институтами России.

С нами вы становитесь еще успешнее!

### Наши контакты:

**Телефон:** +7 812 627 14 35

**Электронная почта:** [sales@st-electron.ru](mailto:sales@st-electron.ru)

**Адрес:** 198099, Санкт-Петербург,  
Промышленная ул, дом № 19, литера Н,  
помещение 100-Н Офис 331