

Description

Excellent unidirectional switches for phase control applications such as heating and motor speed controls. Standard phase control SCRs are triggered with few milliamperes of current at less than 1.5V potential.

Features & Benefits

- RoHS compliant
- Voltage capability up to 1600 V
- Surge capability up to 520 A
- Electrically isolated package "KD-Package" and UL recognized for 2500V_{RMS}

Agency Approval

Agency	Agency File Number
	E71639

Applications

Typical applications are AC solid-state switches, industrial power tools, line rectification 50/60Hz.

Main Features

Symbol	Value	Unit
$I_{T(RMS)}$	55	A
V_{DRM}/V_{RRM}	1600	V
I_{GT}	70	mA

Schematic Symbol

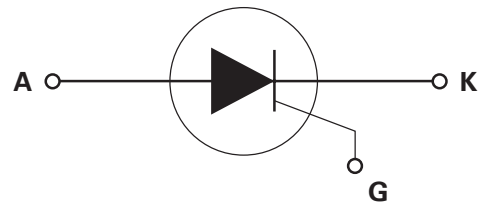

Absolute Maximum Ratings

Symbol	Parameter	Test Conditions	Value	Unit
V_{DRM}/V_{RRM}	Repetitive Peak off-state/Reverse Voltage		1600	V
V_{DSM}/V_{RSM}	Non-repetitive peak off-state/Reverse voltage		1700	V
$I_{T(RMS)}$	RMS on-state current	$T_c = 55^\circ\text{C}$	55	A
$I_{T(AV)}$	Average on-state current	$T_c = 55^\circ\text{C}$	35	A
I_{TSM}	Peak non-repetitive surge current	single half cycle; $f = 50\text{Hz}$; $T_j(\text{initial}) = 25^\circ\text{C}$	550	A
		single half cycle; $f = 60\text{Hz}$; $T_j(\text{initial}) = 25^\circ\text{C}$	660	
I^2t	I^2t Value for fusing	$t_p = 8.3 \text{ ms}$	1800	A^2s
di/dt	Critical rate of rise of on-state current		150	$\text{A}/\mu\text{s}$
I_{GM}	Peak gate current	$T_j = 125^\circ\text{C}$	3	A
$P_{G(AV)}$	Average gate power dissipation	$T_j = 125^\circ\text{C}$	1	W
T_{stg}	Storage temperature range		-40 to 150	$^\circ\text{C}$
T_j	Operating junction temperature range		-40 to 125	$^\circ\text{C}$

Electrical Characteristics ($T_J = 25^\circ\text{C}$, unless otherwise specified)

Symbol	Test Conditions		Value	Unit
I_{GT}	$V_D = 12\text{V}; R_L = 30\ \Omega$	MAX.	70	mA
V_{GT}		MAX.	1.5	V
dv/dt	$V_D = 2/3 V_{DRM}$; gate open; $T_J = 125^\circ\text{C}$	MIN.	2000	V/ μs
V_{GD}	$V_D = V_{DRM}$; $R_L = 3.3\ \text{k}\Omega$; $T_J = 125^\circ\text{C}$	MIN.	0.2	V
I_H	$I_T = 500\text{mA}$ (initial)	MAX.	200	mA
t_q	$I_T = 0.5\text{A}$; $t_p = 50\mu\text{s}$; $dv/dt = 5\text{V}/\mu\text{s}$; $di/dt = 30\text{A}/\mu\text{s}$	TYP.	20	μs
t_{gt}	$I_G = 2 \times I_{GT}$; $PW = 15\mu\text{s}$; $I_T = 110\text{A}$	TYP.	5	μs

Static Characteristics

Symbol	Test Conditions		Value	Unit
V_{TM}	$I_T = 110\text{A}$; $t_p = 380\mu\text{s}$	MAX.	1.8	V
I_{DRM} / I_{RRM}	V_{DRM} / V_{RRM}	$T_J = 25^\circ\text{C}$	10	μA
		$T_J = 125^\circ\text{C}$	8	mA

Thermal Resistances

Symbol	Parameter	Value	Unit
$R_{\theta(J-C)}$	Junction to case (AC)	1.0	$^\circ\text{C}/\text{W}$

Figure 1: Normalized DC Gate Trigger Current vs. Junction Temperature

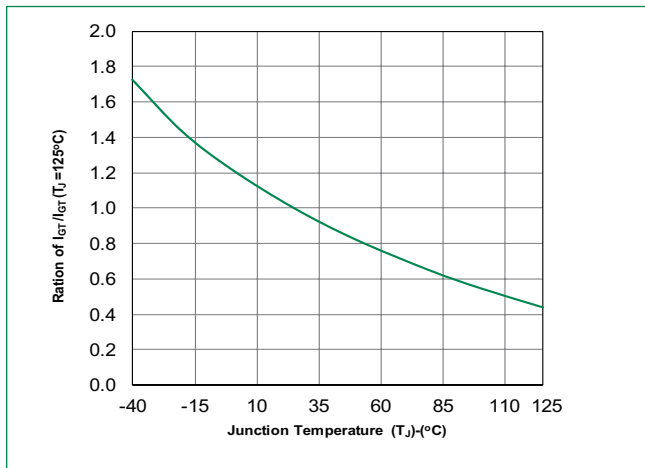

Figure 2: Normalized DC Gate Trigger Voltage vs. Junction Temperature

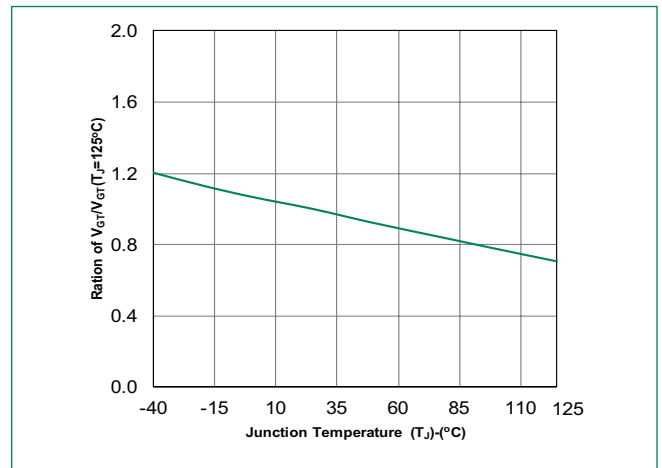

Figure 3: Normalized DC Holding Current vs. Junction Temperature

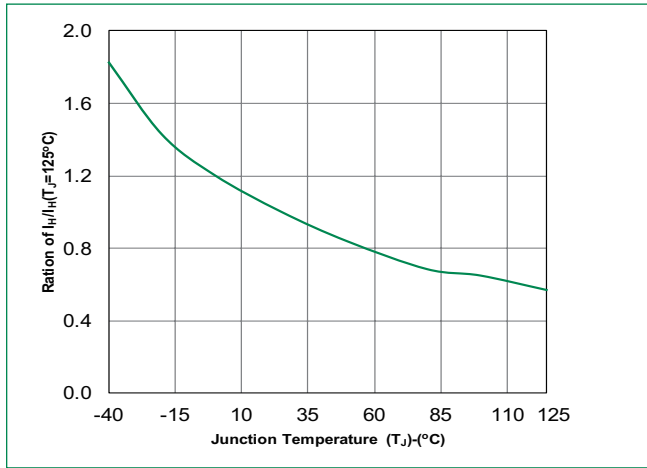

Figure 4: On-State Current vs. On-State Voltage (Typical)

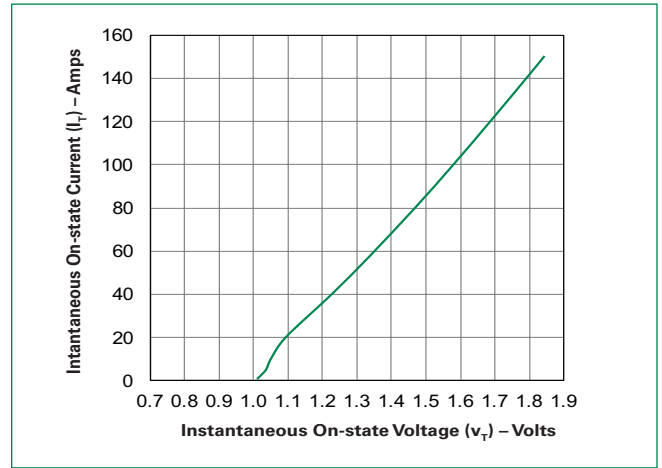

Figure 5: Power Dissipation (Typical) vs. RMS On-State Current

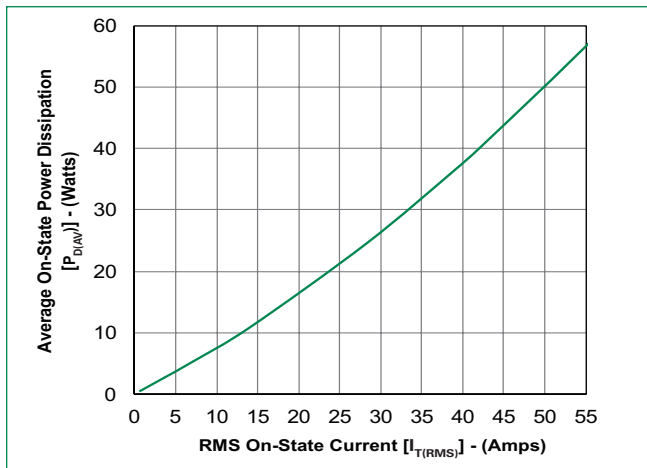

Figure 6: Maximum Allowable Case Temperature vs. RMS On-State Current

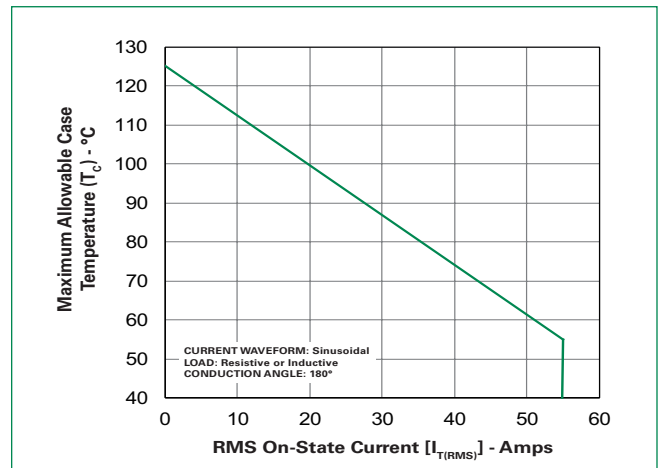

Figure 7: Maximum Allowable Case Temperature vs. Average On-State Current

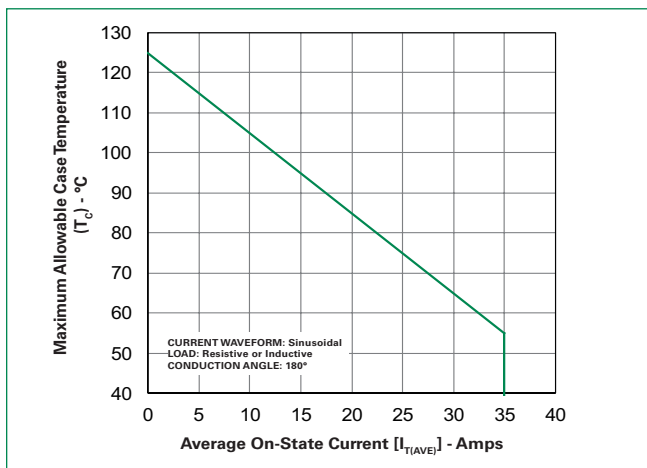
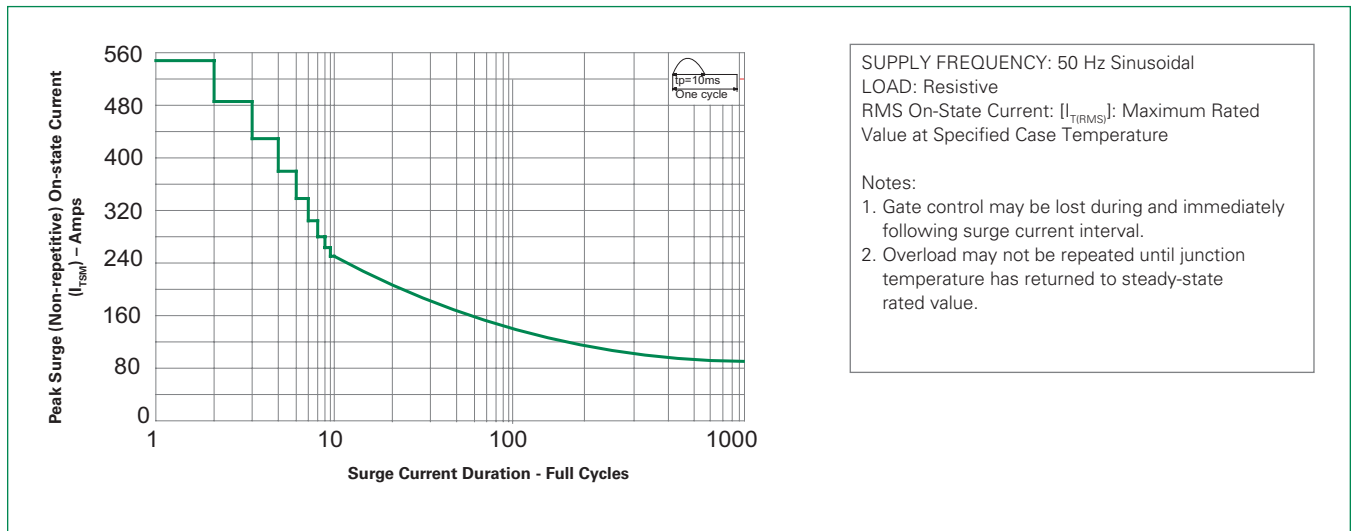

Figure 8: Surge Peak On-State Current vs. Number of Cycles



Design Considerations

Careful selection of the correct device for the application's operating parameters and environment will go a long way toward extending the operating life of the Thyristor. Good design practice should limit the maximum continuous current through the main terminals to 75% of the device rating. Other ways to ensure long life for a power discrete semiconductor are proper heat sinking and selection of voltage ratings for worst case conditions. Overheating, overvoltage (including dv/dt), and surge currents are the main killers of semiconductors. Correct mounting, soldering, and forming of the leads also help protect against component damage.

Environmental Specifications

Test	Specifications and Conditions
AC Blocking	JESD22-A108C, 80% V_{DRM} @125°C for 168 hours
Temperature Cycling	JESD22-A104D, M-1051, 50 cycles; -50°C to +150°C; 15-min dwell-time
Temperature/Humidity	EIA / JEDEC, JESD22-A101 168 hours; 100V - DC: 85°C; 85% rel humidity
Resistance to Solder Heat	JESD22-B106C
Solderability	ANSI/J-STD-002, category 3, Test A

Dimensions – TO-218AC (KD Package) – Isolated Mounting Tab Common with Center Lead

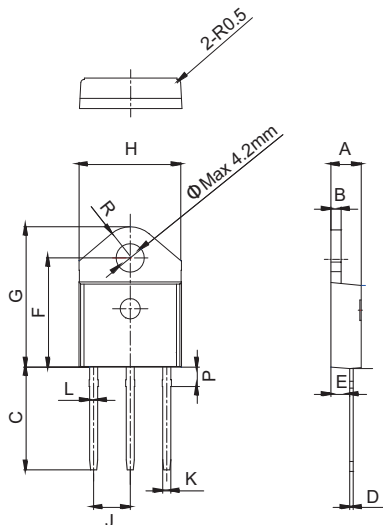

Note: Maximum torque to be applied to mounting tab is 7 in.-lbs. (0.8 Nm).

Dimension	Millimeters			Inches		
	Min.	Typ.	Max.	Min.	Typ.	Max.
A	4.40		4.60	0.173		0.181
B	1.45		1.55	0.057		0.061
C	14.35		15.60	0.565		0.614
D	0.50		0.70	0.020		0.028
E	2.70		2.90	0.106		0.114
F	15.80		16.50	0.622		0.650
G	20.40		21.10	0.803		0.831
H	15.10		15.50	0.594		0.610
J	5.40		5.65	0.213		0.222
K	1.10		1.40	0.043		0.055
L	1.35		1.50	0.053		0.059
P	2.80		3.00	0.110		0.118
R		4.35			0.171	

Product Selector

Part Number	Gate Sensitivity	Type	Package
SK655KD	70mA	Standard SCR	TO-218AC

Packing Options

Part Number	Marking	Weight	Packing Mode	Base Quantity
SK655KDTP	SK655KD	4.8g	Tube	450 (30 per tube)

Part Numbering System

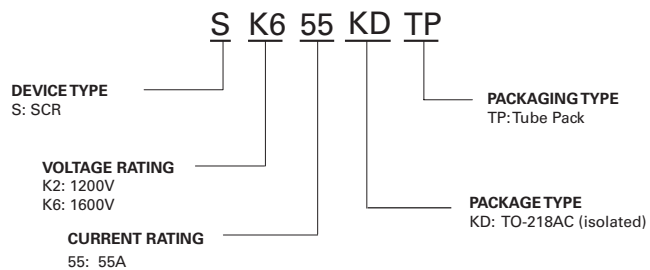

Part Marking System

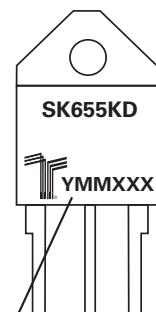

Date Code Marking
Y: Year Code
MM: Month Code
XXX: Lot Serial Code



Стандарт Электрон Связь

Мы молодая и активно развивающаяся компания в области поставок электронных компонентов. Мы поставляем электронные компоненты отечественного и импортного производства напрямую от производителей и с крупнейших складов мира.

Благодаря сотрудничеству с мировыми поставщиками мы осуществляем комплексные и плановые поставки широчайшего спектра электронных компонентов.

Собственная эффективная логистика и склад в обеспечивает надежную поставку продукции в точно указанные сроки по всей России.

Мы осуществляем техническую поддержку нашим клиентам и предпродажную проверку качества продукции. На все поставляемые продукты мы предоставляем гарантию .

Осуществляем поставки продукции под контролем ВП МО РФ на предприятия военно-промышленного комплекса России , а также работаем в рамках 275 ФЗ с открытием отдельных счетов в уполномоченном банке. Система менеджмента качества компании соответствует требованиям ГОСТ ISO 9001.

Минимальные сроки поставки, гибкие цены, неограниченный ассортимент и индивидуальный подход к клиентам являются основой для выстраивания долгосрочного и эффективного сотрудничества с предприятиями радиоэлектронной промышленности, предприятиями ВПК и научно-исследовательскими институтами России.

С нами вы становитесь еще успешнее!

Наши контакты:

Телефон: +7 812 627 14 35

Электронная почта: sales@st-electron.ru

Адрес: 198099, Санкт-Петербург,
Промышленная ул, дом № 19, литера Н,
помещение 100-Н Офис 331