

# › Plug-In Timer 11 pins

- › Multifunction or monofunction
- › Compact body for space saving
- › Wide time range (from 0.5 seconds to 10 days delay)
- › Universal power supply (12-240 V $\sim$ )
- › 1 or 2 relay outputs (SPDT / Changeover)
- › Protective cover
- › LED status indicator
- › 3-wire PNP sensor compatible
- › 11-pins connections



*PU2R10MV1*  
Multifunctions U -  
Monofunction Ad -  
Instantaneous



*PA2R10MV1*  
Monofunction A, At



*PC2R10MV1*  
Monofunction C



*PL2R10MV1*  
Monofunction L, Li

Product selection			
Function	Output	Supply Voltage	Part Number
<b>Multifunction U:</b> (A, At, B, C, H, Ht, D, Di, Ac, Bw) Ad - Instantaneous	2 relays	12 to 240 V $\sim$	<b>PU2R10MV1</b>
A, At	2 relays	12 to 240 V $\sim$	<b>PA2R10MV1</b>
C	2 relays	12 to 240 V $\sim$	<b>PC2R10MV1</b>
L, Li	2 relays	12 to 240 V $\sim$	<b>PL2R10MV1</b>

## PART NUMBERING SYSTEM

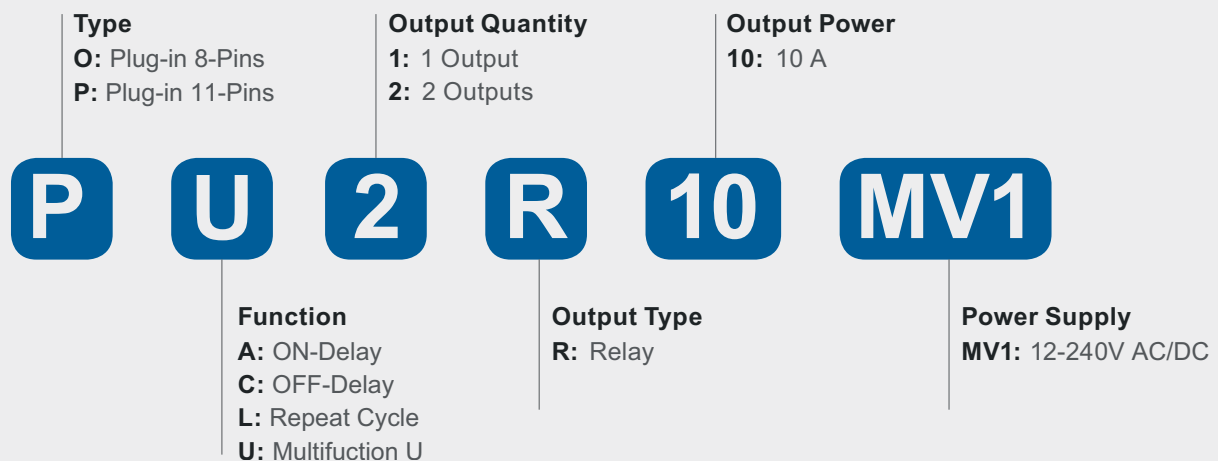

You have a project? Contact us on [www.crouzet.com](http://www.crouzet.com)

**Description:**

Syr-line, the new specialized range at Crouzet, aimed to satisfy the most unique requirements of your applications by innovating in design, engineering and development.

The Plug in Analog Timers, a new family of 11 timers with multifunction or monofunction, universal power supply, wide time range, with all the classic functions.

For more information about Crouzet's Syr-line range, please visit [www.crouzet.com](http://www.crouzet.com).

	PU2R10MV1	PA2R10MV1	PC2R10MV1	PL2R10MV1
<b>Power Supply</b>				
Rated supply voltage Un	12 to 240 V $\sim$			
Voltage supply tolerance	-15 %, +10 %			
AC supply voltage frequency	50 / 60 Hz $\pm$ 5%			
Galvanic isolation of supply / inputs	No			
Power consumption @ Un	Approx. 3 VA (V $\sim$ ) 1.5 W (V $\text{---}$ )			
Immunity to power micro cuts	10 ms			
<b>Timing Control</b>				
Specified time ranges (7) (IEC 1812-1)	0.5..10 s, 0.05..1 min, 0.5..10 min, 0.05..1 h, 0.5..10 h, 0.05..1 day, 0.5..10 days			
Minimum control pulse duration (IEC 1812-1)	40 ms 100 ms with load			
Recovery time (after by de-energisation) (IEC 1812-1)	120 ms			
Repeatability (IEC 1812-1)	$\leq \pm 0.5$ %			
Setting Accuracy (IEC 1812-1)	$\leq \pm 10$ %			
Temperature drift	$\leq \pm 0.05$ % / $^{\circ}\text{C}$			
Voltage drift	$\leq \pm 0.2$ % / V			
<b>Relay output</b>				
Contact arrangement	2 CO (SPDT) (ChangeOver -Single Pole Double Throw-) R1: Follow timing function R2: Follow timing function / Instantaneous	2 CO (SPDT) (ChangeOver -Single Pole Double Throw-)		
Maximum switching voltage	250 V $\sim$ / 10 A resistive / 125 V $\text{---}$ / 0.3 A resistive			
Switching current rate (resistive)	NO / NC: 10 A 250 V $\sim$ / 10 A 30 V $\text{---}$ @ 25 $^{\circ}\text{C}$ NO / NC: 5 A 250 V $\sim$ / 5 A 30 V $\text{---}$ @ 60 $^{\circ}\text{C}$			
Minimum switching contact	10 mA / 5 V $\text{---}$			
Maximum switching power (resistive)	2500 VA / 300 W			
Electrical life	10 <sup>5</sup> cycles min at 250 V $\sim$ / 10 A resistive (NO only)			
Maximum rate (at max switching power)	360 cycles /hour			
Mechanical life	10 x 10 <sup>6</sup> cycles			
Rated impulse voltage	4 kV (1.2/50 $\mu\text{s}$ )			
Dielectric strength between coil / contacts (IEC 60664-1)	2.5 kV / 1 min / 1 mA / 50 Hz			
Dielectric strength between open contacts	1 kV / 1 min / 1 mA / 50 Hz			
<b>Insulation</b>				
Rated Insulation voltage (IEC 60664-1)	250 V			
Insulation coordination (IEC 60664-1)	Overvoltage category III; pollution degree 2; up to 2000 m above sea level			
Rated impulse voltage (IEC 60664-1)	4 kV (1.2/50 $\mu\text{s}$ )			
Clearance / Creepage distances (IEC 60664-1)	3 mm / 3.2 mm			
Dielectric strength (EN-61812-1)	2.5 kV / 1 min / 1 mA / 50 Hz			
Insulation Resistance (NFC 93 050)	> 500 MOhms / 250 V $\text{---}$ / 1 min			
<b>General specifications</b>				
Status indication (LED)	Un: green LED blinks when count, flash when waiting Y1, continuous ON when supplied R: yellow LED blink when only R2 is ON (instantaneous), continuous ON when the 2 relays are ON.			
Casing	35 mm			
Mounting	Mounting base-mounted on socket			
Housing material (UL94)	Enclosure plastic type V0			
Degree of protection (IEC 60529)	IP40			
Operating temperature (IEC 60068-2)	-20 $^{\circ}\text{C}$ to +60 $^{\circ}\text{C}$			

	PU2R10MV1	PA2R10MV1	PC2R10MV1	PL2R10MV1
Storage temperature (IEC 60068-2)	-40 °C to +70 °C			
Humidity (IEC 60068-2-30)	93 % without condensation			
Vibration resistance (IEC 60068-2-6)	±0.15mm from 10 Hz...60 Hz 2 g from 60 Hz..150 Hz			
Shock resistance (IEC60068-2-27)	10 gn - 11 ms; 3 X 6 axis (Output non-energized) 5 gn - 11 ms; 3 X 6 axis (Output energized)			
Drop to concrete floor (IEC 60068-2-32)	High: 0.75 m			
Weight	90 g 110 g with packaging			

Standards	
CEE Directive: 2014/30/EU 2014/35/EU	EMC Low voltage
Approvals / Marking	CE cULus Listed Industrial Control Equipment
Security standard (IEC 60664-1)	Insulation coordination for equipment within low-voltage systems
Conformity with environmental directives: 2015/863/UE 1907/2006 2012/19/UE	RoHS Reach WEEE
Product standard (IEC 61812-1 / UL 60947-4-1)	Specified time relays for industrial use Industrial Control Equipment (NRNT- Industrial Control Switches) Refer to UL840 Insulation Coordination for Electrical Equipment
Electromagnetic compatibility: IEC 61000-6-2 IEC 61000-6-3 IEC 61000-6-4	Generic standards Immunity for industrial environment Emission residential environment Emission industrial environment
Immunity to electrostatic discharges (IEC61000-4-2)	Level III Air ±8 KV / Contact ±6 KV
Immunity to radiated, radio-frequency, electromagnetic field (IEC61000-4-3)	Level III 10 V/m (80 MHz to 1 GHz) 80 % AM (1 kHz) 3 V/m (1.4 to 2 GHz) 80 % AM (1 KHz) 1 V/m (2 to 2.7 GHz) 80 % AM (1 KHz)
Immunity to rapid transient bursts (IEC 61000-4-4)	direct ±4 kV 5/50 Tr/Th ns 5 KHz & 100 KHz Capacitive coupling clamp ± 2 KV 5/50 Tr/Th ns 5 KHz & 100 KHz
Immunity to shock waves on power supply (IEC 61000-4-5)	Level III: line-to-earth ±2 kV / line-to-line ±1 kV
Immunity to radiofrequency in common mode (IEC 61000-4-6)	Level III: 10 Vrms (0.15 to 80 MHz) 80 % AM (1 kHz)
Immunity to voltage dips and breaks (IEC 61000-4-11)	0 % residual voltage during 1 cycle (Crit. B) 40 % residual voltage / 10 cycles 50 Hz / 12 cycles 60 Hz (Crit. C) 70 % residual voltage / 25 cycles 50 Hz / 30 cycles 60 Hz (Crit. C) Short interruptions: 0 % residual voltage / 250 cycles 50 Hz / 300 cycles 60 Hz (Crit. C)
AC/DC main port emissions (IEC 61000-6-3 IEC 61000-6-4)	CISPR 16-2-1 (7.4.1), CISPR 16-1-2 (4.3) 0.15 MHz – 0.5 MHz, 66 dB(µV) – 56 dB(µV) quasi-peak, 56 dB(µV) – 46 dB(µV) average 0.5 MHz – 5 MHz, 56 dB(µV) quasi-peak, 46 dB(µV) average 5 MHz – 30 MHz, 60 dB(µV) quasi-peak, 50 dB(µV) average CISPR 14-1 0.15 MHz – 30 MHz CISPR 16-2-1 (7.4.1), CISPR 16-1-2 (4.3) 0.15 MHz – 0.5 MHz, 79 dB(µV) quasi-peak, 66 dB(µV) average 0.5 MHz – 30 MHz, 73 dB(µV) quasi-peak, 60 dB(µV) average
Radiated emissions (IEC 61000-6-3 IEC 61000-6-4)	CISPR 16-2-3 30 MHz – 230 MHz, 30 dB(µV/m) Quasi-peak at 10 m 230 MHz – 1 000 MHz, 37 dB(µV/m) Quasi-peak at 10 m Or: 30 MHz – 230 MHz, 40 dB(µV/m) Quasi-peak at 3 m in a semi-anechoic chamber 230 MHz – 1 000 MHz, 47 dB(µV/m) Quasi-peak at 3 m in a semi-anechoic chamber

PU2R10MV1

PA2R10MV1

PC2R10MV1

PL2R10MV1

Function Diagrams

Basic Time Chart

Function A - On-Delay (Delay on make)

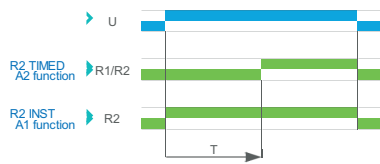

Function Ac - On/Off Delay (Delay on make/break)

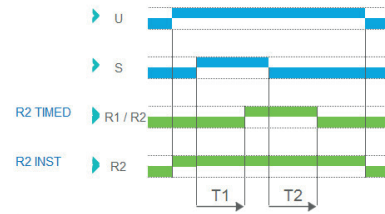

Function Ad - Delay on Start

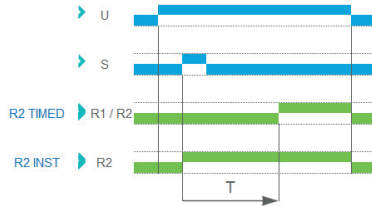

Function At - Summation time relay

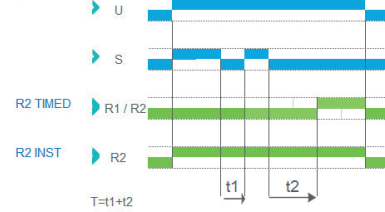

Function B - One-Shot

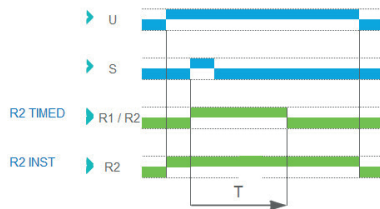

Function Bw

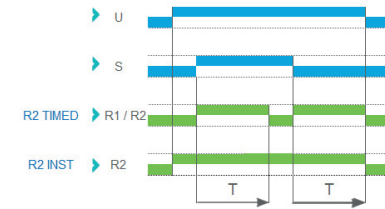

Function C - Off-Delay (Delay on break)

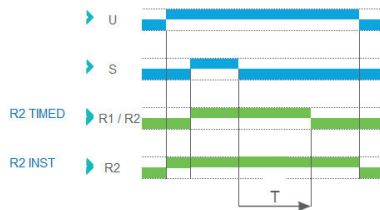

Function D - Symmetrical flashing (OFF Start)



Function Di - Symmetrical flashing (ON Start)

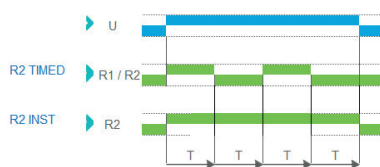

Function H - Interval

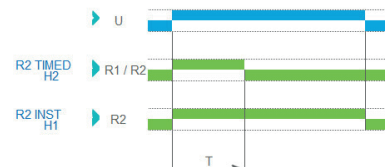

Function Ht - Interval summation time relay

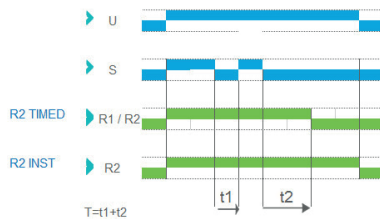

Function L - Recycler (OFF Start)

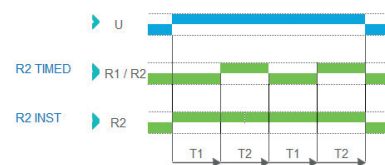

Function Li - Recycler (ON Start)

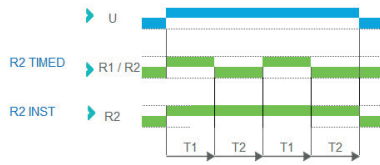

PU2R10MV1	PA2R10MV1	PC2R10MV1	PL2R10MV1
-----------	-----------	-----------	-----------

Connections

PU2R10MV1 - PA2R10MV1 - PC2R10MV1

PL2R10MV1

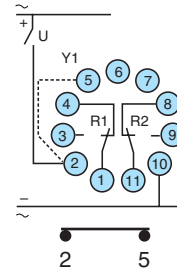
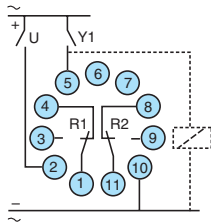

PU2R10MV1	PA2R10MV1	PC2R10MV1	PL2R10MV1
-----------	-----------	-----------	-----------

Outline dimensions (mm)

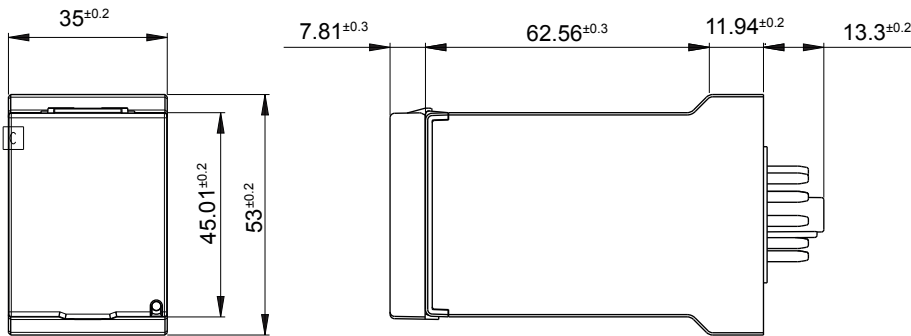

PU2R10MV1	PA2R10MV1	PC2R10MV1	PL2R10MV1
-----------	-----------	-----------	-----------

Socket

RECOMENDED SOCKET

11 Pins for DIN Rail or Panel Mount (P/N: 25 622 080)



Warning:

The product information contained in this catalogue is given purely as information and does not constitute a representation, warranty or any form of contractual commitment. Crouzet Automatismes SAS and its subsidiaries reserve the right to modify their products without notice. It is imperative that we should be consulted over any particular use or application of our products and it is the responsibility of the buyer to establish, particularly through all the appropriate tests, that the product is suitable for the use or application. Under no circumstances will our warranty apply, nor shall we be held responsible for any application (such as any modification, addition, deletion, use in conjunction with other electrical or electronic components, circuits or assemblies, or any other unsuitable material or substance) which has not been expressly agreed by us prior to the sale of our products.



## Стандарт Электрон Связь

Мы молодая и активно развивающаяся компания в области поставок электронных компонентов. Мы поставляем электронные компоненты отечественного и импортного производства напрямую от производителей и с крупнейших складов мира.

Благодаря сотрудничеству с мировыми поставщиками мы осуществляем комплексные и плановые поставки широчайшего спектра электронных компонентов.

Собственная эффективная логистика и склад в обеспечивает надежную поставку продукции в точно указанные сроки по всей России.

Мы осуществляем техническую поддержку нашим клиентам и предпродажную проверку качества продукции. На все поставляемые продукты мы предоставляем гарантию .

Осуществляем поставки продукции под контролем ВП МО РФ на предприятия военно-промышленного комплекса России , а также работаем в рамках 275 ФЗ с открытием отдельных счетов в уполномоченном банке. Система менеджмента качества компании соответствует требованиям ГОСТ ISO 9001.

Минимальные сроки поставки, гибкие цены, неограниченный ассортимент и индивидуальный подход к клиентам являются основой для выстраивания долгосрочного и эффективного сотрудничества с предприятиями радиоэлектронной промышленности, предприятиями ВПК и научно-исследовательскими институтами России.

С нами вы становитесь еще успешнее!

### Наши контакты:

**Телефон:** +7 812 627 14 35

**Электронная почта:** [sales@st-electron.ru](mailto:sales@st-electron.ru)

**Адрес:** 198099, Санкт-Петербург,  
Промышленная ул, дом № 19, литера Н,  
помещение 100-Н Офис 331